

# TG uni 1

Appliance tester for  
testing safety measures in accordance  
with DIN VDE 0701 and 0702

Operating Manual  
Version 1.07



Contents	Page	Contents	Page
<b>1. Safety information</b>	<b>4</b>	<b>8. Conducting tests:</b>	
<b>2. Introduction</b>	<b>4</b>	<b>Explanation of terminology</b>	<b>14</b>
2.1 Model and type designation / identification	5	8.1 Touch current ( $I_t$ )	14
2.2 Product description	5	8.2 Differential current ( $I_D$ )	14
2.3 Other equipment features	5	8.3 Substitute leakage current ( $I_{SL}$ )	14
2.4 Scope of delivery	5	8.4 Insulation resistance ( $R_{INS}$ )	15
2.5 Optional accessories	5	8.5 Protection class I (PC I)	15
2.6 Transport and storage	5	8.6 Protection class II (PC II)	15
<b>3. Safety instructions</b>	<b>6</b>	8.7 Protection class III (PC III)	15
<b>4. Appropriate usage</b>	<b>7</b>	8.8 Protective conductor current ( $I_{PE}$ )	16
<b>5. Operating elements</b>	<b>8</b>	8.9 Protective conductor resistance ( $R_{PE}$ )	16
5.1 Meaning of the signal tones	8	8.10 Visual inspection	16
<b>6. Commissioning</b>	<b>9</b>	<b>9. Conducting tests in accordance with</b>	
6.1 Basic settings of the tester	9	<b>DIN VDE 0701 and DIN VDE 0702:</b>	
6.2 Compensation of the measuring line	10	<b>Definition of standards</b>	<b>17</b>
6.3 Setting the measuring method for protective conductor current measurement	10	9.1 Visual inspection	17
6.4 Setting the date	11	9.2 Measuring the protective conductor resistance	17
6.5 Selection of the data memory	11	9.3 Measuring insulation resistance	17
6.6 Changing the duration of a test stage	12	9.4a Measuring the protective conductor current	18
6.7 Entering the name of the inspector	12	9.4b Measuring touch current	19
6.8 Customer-specific settings	12	9.5 Inspecting the inscriptions	19
<b>7. Conducting tests:</b>		9.6 Function test	19
<b>General information on</b>		9.7 Documentation	19
<b>DIN VDE 0701 and DIN VDE 0702</b>	<b>13</b>	9.8 Diagram 1: Test procedure for devices of protection class I	20
7.1 Why	13	9.9 Diagram 2: Test procedure for devices of protection classes II und III	21
7.2 What	13		
7.3 How	13		

Contents	Page	Contents	Page
<b>10. Conducting tests with the appliance tester in accordance with DIN VDE 0701 and DIN VDE 0702, PC I</b>	<b>22</b>	<b>15. Technical data</b>	<b>42</b>
10.1 Visual inspection	23	15.1 Technical data for function tests	43
10.2 Protective conductor resistance	23	15.2 General technical data	43
10.3 Insulation resistance	24	<b>16. Manufacturer's guarantee conditions</b>	<b>44</b>
10.4a Protective conductor current (substitute leakage current)	25		
10.4b Protective conductor current	25		
10.5 Function test	26		
10.6 Inspecting the inscriptions	26		
10.7 Documentation	27		
<b>11. Conducting tests with the appliance tester in accordance with DIN VDE 0701 and DIN VDE 0702, PC II</b>	<b>29</b>		
11.1 Visual inspection	30		
11.2 Insulation resistance	30		
11.3a Touch current (substitute leakage current)	31		
11.3b Touch current	31		
11.4 Function test	32		
11.5 Inspecting the inscriptions	32		
11.6 Documentation	33		
<b>12. Conducting tests with the appliance tester in accordance with DIN VDE 0701 and DIN VDE 0702, PC III</b>	<b>35</b>		
12.1 Visual inspection	36		
12.2 Insulation resistance	36		
12.3 Documentation	37		
<b>13. Conducting tests with the appliance tester in accordance with DIN VDE 0702, all protection classes</b>	<b>39</b>		
<b>14. Conducting tests with the appliance tester in accordance with DIN VDE 0701 and DIN VDE 0702 - special test procedure according to customer-specific settings</b>	<b>40</b>		

### 1. Safety information

Tests on the electrical safety of electrical appliances may only be carried out by qualified electricians or under their supervision. Carefully read the following safety information before commissioning the TG uni 1 appliance tester (referred to as appliance tester or tester in the following).

Symbols used in the operating manual and on the tester:



Warning: hazardous situation. Follow the operating manual.



Caution! Dangerous voltage, danger of electric shock.



Note. Make sure you follow the manual.



CE mark of conformity.



The operating manual contains information and notes which are necessary for the safe operation and use of the tester. Before use (commissioning / installation) of the tester the operating manual should be carefully read through and followed in all points.



If the manual is not observed or if you fail to observe the warnings and notes, serious injury to the user and damage to the tester can occur.



All the technical data and quoted standards in this manual are up-to-date at the time of going to press and have been determined to the best of our knowledge, nevertheless this data may be subject to errors and printing errors. Therefore no legal responsibility or any other liability can be accepted for incorrect information or the consequences of this information.

**The definitive document for carrying out tests is the original version of the respective regulation or standard.** There is no intention to infringe on any existing patents and other property rights with this publication.

### 2. Introduction

You have acquired a high-grade device from the company Gossen Müller & Weigert (GMW), with which you can carry out repeatable measurements over a very long period of time. The product was calibrated during the manufacturing process in accordance with the specified operating procedures. All quality-relevant activities and processes carried out in GMW are permanently monitored as part of the quality management system in accordance with DIN EN ISO 9001:2000.

### 2.1 Model and type designation / identification

A type plate and serial number sticker are situated on the inside of the housing cover (behind the accessories bag). In the case of queries, always give the product designation and serial number.

### 2.2 Product description

The appliance tester has been developed for carrying out the following measurements for testing the safety of electrical appliances in accordance with DIN VDE 0701 and 0702 (BGV A3):

- Measuring protective conductor resistance with compensation of the measuring line
- Measuring insulation resistance
- Measuring substitute leakage current
- Measuring protective conductor current (direct method or as differential current)
- Measuring touch current
- Function test with measurement of mains voltage, load current, active power, apparent power and reactive power, power factor and frequency
- Testing of non-heating devices and extension cables

### 2.3 Other equipment features

- Stable, dust-proof carrying case as housing
- Large, easy-to-read touch-screen for operating the tester (backlit)
- Good/bad display in plain text (suitable for technically trained persons)
- Connection for barcode scanner for reading-in the test object's ID numbers
- USB-interface
- MMC-card for saving and transporting measured data
- PC standard software for saving and printing measurement reports

### 2.4 Scope of delivery

- 1 TG uni 1 appliance tester
- 1 safety test line, length 100 cm
- 1 safety crocodile clip, clip width 30 mm
- 1 safety test tip
- 1 USB cable, length 150 cm
- 1 MMC memory card 128 MB
- 1 CD-ROM with Windows®-PC standard software
- 1 accessories bag with velcro fastener and quick guide
- 1 operating manual

### 2.5 Optionale accessories

(not included in delivery)

- Barcode scanner
- RS232 PC interface cable, length 200 cm
- Measuring adapter for testing devices with tree-phase connection (in preparation for plug connectors CEE 3-pole, 16 A, 230 V; CEE 5-pole, 16 A, 400 V and CEE 5-pole, 32 A, 400 V)
- Adapter for checking extension cables
- PC software with database functions (customer master data, device master data, test data, analysis function, data backup)

### 2.6 Transport and Storage

Please retain the original packaging for dispatch at a later date, e.g. for calibration. Transport damage that occurs due to inadequate packaging is not covered by the manufacturer's guarantee.

The tester must be stored in a dry, closed room. If the device it transported in extreme temperatures, it requires at least 2 hours acclimatisation before being switched on.

#### 3. Safety instructions

The appliance tester TG uni 1 was constructed and tested in accordance with the applicable safety regulations and left the workshop in a faultless safety condition. In order to maintain this condition and ensure safe operation, the user must observe the instructions and warnings contained in this operating manual.

 With all work, the applicable accident prevention regulations of the trade associations for electrical systems and equipment must be observed.

 To avoid electric shock, the applicable safety regulations and DIN-VDE regulations regarding high touch voltage must be observed without fail when working with voltages greater than 120V (60 V) DC or 50 V (25 V) eff. AC. The values in brackets apply for restricted areas (e.g. medicine, agriculture).

Measuring at a dangerous proximity to electrical systems should only be carried out under the instruction of a responsible electrician, and never alone.

Check the tester and the connecting cables for external damage before every new operation.

Make sure that the tester and the connecting cables are in faultless condition. The tester may not be used if one or more functions fail or if functional readiness is not evident.



The measuring lines and the measuring accessories may only be touched in the designated handling areas. Touching measuring connections, e.g. test tips must be avoided under all circumstances.



If the safety of the operator is no longer guaranteed, the tester must be decommissioned and secured against unwanted use. This is the case if the device:

- shows obvious signs of damage
- no longer carries out the required measurements
- has been stored in adverse conditions for too long

The tester may only be used in the operating and measuring ranges specified under Technical Data.

Prevent overheating of the tester by exposure to direct sunlight. Only this will guarantee faultless functioning and a long service life of the device.

Never open the housing of the tester because of the danger of high voltages. The tester contains no parts that can be replaced by the user.

Only let the tester be serviced by qualified personnel.

#### 4. Appropriate usage

The tester may only be used under the conditions and for the purposes for which it has been designed. It is particularly important to observe the safety instructions and the technical data regarding ambient conditions and usage in a dry environment.

The tester may not be used for measurement in electrical systems.

The tester may only be plugged into a properly connected earthed mains socket. This may be protected with a maximum 16 A!

The tester is designed for operation with a rated voltage of 230 V AC 50 Hz, it may never be connected to higher voltage.

The maximum output current of the mains socket is 16 A!

The tester may not be used for constant measuring.

Operational safety is no longer guaranteed in the case of modifications or conversions that have not been carried out by the manufacturer.

Maintenance or calibration work may only be carried out by the manufacturer.

If the tester has been exposed to an electromagnetic field, this can impair the functionality of the tester.

The tester may not be used near to explosive gasses, steam or dust, or in a damp environment.

In order to avoid damaging the testing device, the test socket and the measurement connections may not be connected to an external voltage source.

Only the supplied original measuring lines or equivalent safety measuring accessories may be used!

# Operating manual for the TG uni 1 appliance tester

## Operating elements

### 5. Operating elements

Explanation of the tester's connections, operating elements and displays

Mains cable with mains plug for connecting the Tester to the mains power supply 230 V +/-15%, 50 Hz

Thermal fuse for the test object and tester F 16 A

ON / OFF switch

Card slot for an MMC memory card

USB socket for connecting a PC

RS232 socket for connecting a barcode scanner

Storage compartment for the mains cable

Test / mains socket for connecting the test object with earthed plug , 230 V 16 A, 50 Hz

Optional connecting sockets (VDE 0751):

L1 (black)

N (blue)

L<sub>EPA</sub> (red)

Connecting socket 'PE' (yellow/green), parallel connection of the protective conductor of the test socket, for connecting the test object without an earthed mains plug

connecting socket 'Probe' (red), for the test line when measuring R<sub>PE</sub> and R<sub>INS</sub>

Touch-screen (LC display and control screen)

Symbols used in the LC display:

 - internal memory

 - MMC memory card



Front panel, Fig. 1



Housing cover with 2 snap fasteners

Accessories bag with quick guide

Handle (fold-away)

Case housing  
Fig. 2

#### 5.1 Meaning of the signal tones

- short single tone: confirmation of button press
- short double tone: end of a test stage with automatic procedure
- long single tone, continuous tone: fault



## 6. Commissioning

The tester is equipped with modern touch-screen technology. That means that the LC display and the control buttons are in one control screen. The control buttons are always edged.

After activating the mains switch a self-test is carried out. If everything is in order, the following display appears on the touch-screen as a **switch-on message** (Fig. 3):

Fig. 3

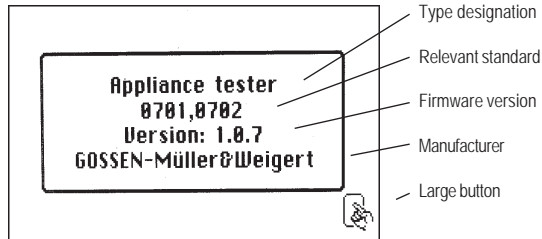

Continue with large button (Fig. 3).

A display for entering the date appears (Fig. 3a).

Fig. 3a

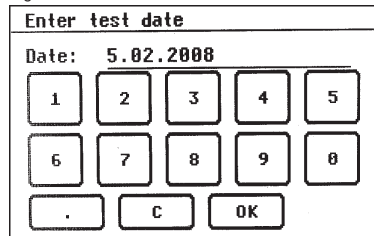

As the tester does not have its own real-time clock, you are prompted to confirm the displayed date or enter a new date.

☞ Also see Point 6.4.

After confirmation with the [OK] button the **Main menu** appears (Fig. 4):

Fig. 4

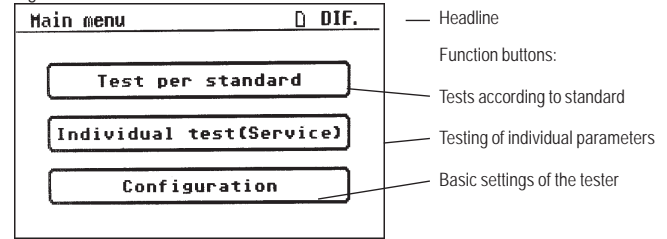

### 6.1 Basic settings of the tester

Press the [Configuration] button in the Main menu (Fig. 4).

The **Configuration menu** appears (Fig. 5):

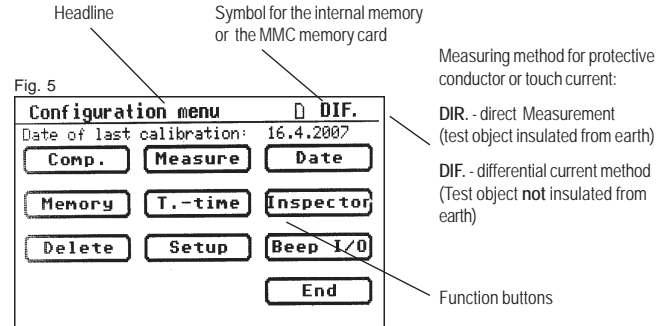

## 6.2 Compensation of the measuring line

In order to achieve correct results when measuring the protective conductor resistance, the resistance of the measuring line must be compensated (zero balance).

Press the function button [Comp.] (Fig. 5).

The zero balance menu appears. Follow the instructions in the display (Fig. 6):

Fig. 6

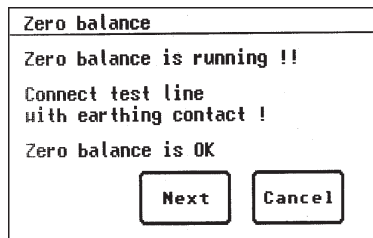

– Connect the test tip/test clip with the measuring line and insert the measuring line plug in the 'Probe' socket (Fig. 1).

– Connect the test tip/test clip with the protective earthing contact of the test socket.

If the following message appears in the display:

„Fault: zero balance“

and a permanent warning signal sounds, the measuring line resistance is greater than 2  $\Omega$  and cannot be compensated.

The protective conductor resistance test is locked.

In this case the measuring line should be checked or be replaced with a low-impedance version.

If the measuring line has been successfully compensated – the following message appears in the display

„Zero balance OK“.

Press the [Next] button, only then disconnect the line!

## 6.3 Setting the measurement method for protective conductor current measurement (also current touch measurement)

In the case of devices of protection class I, on which the insulation resistance measurement cannot or may not be carried out, the protective conductor current measurement is an alternative measurement for determining the insulating capacity.

The protective conductor current can be determined either by the direct measuring method, the differential current method or the substitute leakage current method.

The direct measuring method or the differential current method should be used with test objects that can only be switched on with mains voltage (also see Point 9.8).



**Caution!** In this case the test object is supplied with mains voltage during the test.

The differential current measurement determines the total leakage current of the test object by measuring the total current of all active conductors (L-N). The differential current measurement must be applied if the test object has additional earthing connections or cannot be insulated.

Direct measurement can be applied if the test object has no additional earthing connections or can be insulated.

In order to change the measuring method, press the [Measure] function button in the configuration menu, see Fig. 5.

The symbol in the headline changes accordingly:

[DIR.] – direct measurement

[DIF.] – differential current method

#### 6.4 Setting the date

You can set the test date on the tester.

Press the function button [Date] to change to the input screen (Fig. 5). The date is entered on the touch-screen by means of the pictured 10-button keypad (Fig. 7).

The date can be entered in the following formats:  
|D.M.YY|, |DD.MM.YY| and |DD.MM.YYYY|.

The set date is saved along with the measuring results of every test and also appears in the log printout.

Fig. 7

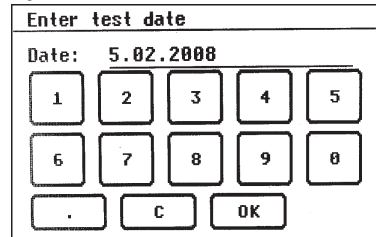

-  once the date has been set, it remains unchanged in the tester's memory until it is reentered or deleted
- the tester is **not** equipped with a real-time clock!

#### 6.5 Selection of the data memory

To save the measurement results, the tester has an internal memory (16 MB) and an MMC memory card (128 MB, supplied with the tester).

The MMC memory card can be used to backup or transfer the measurement results.

MMC memory cards with a capacity of 128 to 256 MB can be used.

Inserting the MMC memory card:

Insert the memory card, with the label facing down, into the card slot and slightly press until it engages.

To eject the memory card, press it down until it disengages and pull the card upwards and out of the slot.

#### Caution!

**Never force the memory card into the card slot of the tester. The use of force can damage the memory card and the card slot. If the card is not recognised by the tester, check if it has been properly inserted.**

Press the function button [Memory] in the configuration menu to switch between the internal memory and the MMC memory card. The symbol in the headline changes accordingly (Fig. 5):



- internal memory



- MMC memory card

-  The measurement results can be stored **either** in the internal memory **or** on the MMC memory card.

Use a PC with a USB connection if you wish to completely delete or format the MMC memory card. After the USB connection has been made the MMC memory card appears as an external storage medium in the file manager. From here the card can be deleted or formatted – the file system is automatically adjusted.

**Caution! Formatting a memory card deletes all the data on the card.**

To read out saved measurement results - see the operating manual of the PC software

### 6.6 Changing the duration of a test stage

With automatic test procedures, the preset duration of every test stage is 5 seconds.

This setting can be changed, if for example the test object requires a longer time to be switched on.

To do this press the function button [T.time] in the configuration menu. Using the 10-button keypad, you can enter a new test time in the next screen (Fig. 8).

The possible setting range is 3 to 254 seconds.

The factory setting of the tester is 5 seconds per test stage.

Fig. 8

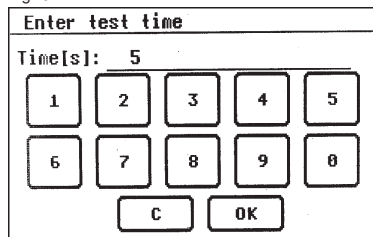

### 6.7 Entering the name of the inspector

To enter the name or designation of the inspector, press the function button [Inspector] in the configuration menu.

The screen changes to an alphanumeric keypad, with which you can enter the name or the designation of the inspector. The input field has 20 characters (Fig. 9).

You can switch between letter and numeric keys by using the buttons [123] or [ABC].

The [C] button deletes the last entered character.

Press the [OK] button to confirm the entry.

The entered name is saved in the memory after the tester has been switched off.

 The entered name is assigned to every test carried out and also appears in the log printout.

Fig. 9



### 6.8 Customer-specific settings

The scope of functions of the tester can be adapted to customer specifications. This can simplify the operation of the tester.

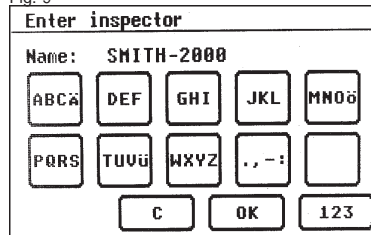
**These settings do not change the standard conformity of the tester!**

You reach the setup menu by pressing the function button [Setup] in the configuration menu (Fig. 5).

 This input area is locked by a code key (Fig. 10)

Please contact us for further information:

Fig. 10 Tel. +49 (0)911 / 3502-0, Fax +49 (0)911 / 3502-307.

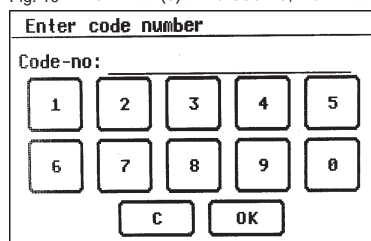

## 7. Conducting tests:

General information on DIN VDE 0701 and DIN VDE 0702

### Why, What, How

#### 7.1 Why?

Electrical systems and equipment must be safe. They have to be manufactured and operated in such a way that they cannot endanger people, animals and property.

The legal regulations are primarily anchored in:

- The German Ordinance on Industrial Safety and Health ( BetrSichV)
- The Accident Prevention Regulations (BGV A 3)
- The DIN-VDE standards harmonised within the EU

The stipulation for transportable devices states:

„The manufacturer or the importer of technical equipment may only bring this equipment onto the market if, in accordance with the generally recognised rules of technology, the user or third parties are protected from danger when using this equipment for its intended purpose, as far as the form of appropriate usage allows.“

(from the German Ordinance on Industrial Safety and Health )

The operator has to ensure that the electrical systems and equipment are operated in accordance with the rules pertaining to electrical equipment.

(from BGV A 3 Electrical systems and equipment)

Those who manufacture or modify transportable devices must comply with the applicable standards, e.g.:

DIN VDE 0700 Part 1 „Household and similar electrical appliances - Safety“.

#### 7.2 What?

Whoever operates, services and repairs transportable devices must observe the following:

**DIN VDE 0701** „Repair, modification and inspection of electrical appliances“ Part 1 as well as the special provisions of this standard

For those commissioned with regular tests, the applicable specifications are contained in **DIN VDE 0702** „Periodic inspection on electrical appliances“.

Requirements for the appliance tester from the VDE regulations:

Safety tests on transportable electrical equipment are based on

– **DIN VDE 0701**  
„Repair, modification and inspection of electrical appliances“

– **DIN VDE 0702**  
„Periodic inspection of electrical appliances“

#### 7.3 How?

Measuring and testing devices must be constructed in accordance with DIN VDE 0404 „Testing and measuring equipment for checking the electric safety of electric devices - Part 1: General requirements“.

Insulation and protective conductor measurements are also subject to the standards DIN VDE 0413 Part 1 and Part 4.

In addition:

DIN VDE 0404 „Testing and measuring equipment for checking the electric safety of electric devices - Part 2“.

## 8. Conducting tests: Explanation of terminology

### 8.1 Touch current ( $I_t$ )

Current that can flow to earth via the person handling the device (test object).

The measurement is carried out between touchable conductive parts of the test object and the earth.

The measurement can either be made directly or with the differential current method.

Direct measurement is applicable if the test object can be insulated from earth.

In all other cases the differential current method should be used.

The touch current measurement is carried out on test objects in protection class II with touchable conductive parts, or on test objects in protection class I, which have touchable conductive parts that are not connected to the protective conductor.

 The measurement is to be carried out in both positions of the mains plug - the reversal of polarity is automatic with the tester - extracting and reversing the mains plug is not necessary.

 Also see measuring principle circuits on Page 19.

### 8.2 Differential current ( $I_D$ )

In terms of the standards DIN VDE 0701/0702, this is the total instantaneous values of all currents flowing through all active conductors on the mains side connection of the device (test object).

The differential current method is a measuring method for determining protective conductor current or touch current.

The total leakage current of a test object can be measured. This measuring method must be applied if the test object cannot be insulated.

 Also see measuring principle circuit M6 on Page 18.



**Caution!** The test object is supplied with mains voltage during the test.

### 8.3 Substitute leakage current ( $I_{SL}$ )

Current that would flow through the interconnected active conductors of the device (test object) and the protective conductor or the touchable conductive parts at nominal voltage and nominal frequency of the device.

This measuring method determines the leakage current without mains voltage. It is an alternative measuring method for determining protective conductor current or touch current.

 Also see measuring principle circuit M4a on Page 18.

---

#### 8.4 Insulation resistance ( $R_{INS}$ )

Ohmic resistance between the conductive parts separated by insulation.

Measurements are taken between the active parts and the body as well as touchable conductive parts that are not connected to the protective conductor.

 Also see measuring principle circuits on Page 17.

#### 8.5 Protection class I (PC I)

The active parts of the device are protected against direct touching by the basic insulation. Through connection of the touchable conductive housing parts to the protective conductor, these are included in the protective action in the case of indirect touching (fault protection) with the system. The device has a protective conductor connection (earthed plug).

#### 8.6 Protection class II (PC II)

The active parts are separated by strengthened or double insulation (basic insulation and additional insulation). This ensures protection against direct contact.

Protection against indirect contact is also given, since an insulation fault is practically impossible. Such devices can nevertheless have touchable metallic housing parts. Devices of protection class II have a mains plug without an earthing contact.

#### 8.7 Protection class III (PC III)

Devices of protection class III are exclusively connected to protective extra-low voltage electric circuits.

The protection against dangerous body currents is achieved by the low voltage and the safe separation to other electric circuits.

### 8.8 Protective conductor current ( $I_{PE}$ )

Current that flows through the protective conductor from the devices (test objects) of protection class I, when their bodies are insulated from earth.

A direct measurement is applicable if the test object can be insulated from earth.

In all other cases the differential current method should be applied, see Point 6.3 (Basic settings of the tester, Page 10).

 Also see measuring principle circuits on Page 18.



**Caution!** The test object is supplied with mains voltage during the test.

### 8.9 Protective conductor resistance ( $R_{PE}$ )

Resistance between any conductive touchable parts, connected to the protective conductor for protective purposes, and the earthed contact of the mains plug, the device plug or the protective conductor, which is constantly connected to the mains power supply.

During the measurement of the protective conductor resistance, the connecting cable should be moved, section by section, along its whole length. This measuring method only applies for devices of protection class I.

 Also see measuring principle circuit M1 on Page 17.

### 8.10 Visual inspection

Testing in accordance with DIN VDE 0701 or 0702 also involves visual inspection of the device.

According to the standard the devices should be inspected for external defects (without opening the device) and, as far as possible, for suitability to the place of installation. In particular, attention should be paid to the following:

- Damage to the housing
- Defects of the cord connector guard and strain relief fittings
- External damage of the connecting cables
- Unauthorised interference and changes
- Signs of overloading and improper use
- Orderly condition of the protective covers
- Safety impairing soiling and corrosion
- Unblocked cooling vents
- Existence of necessary air filters
- Leak tightness, pressure relief valve
- Legibility of safety-related inscriptions
- Fuse links in accordance with manufacturer's specifications

 Externally visible defects, which could lead to a mechanical or fire hazard should be repaired immediately.



9. Conducting tests in accordance with DIN VDE 0701 and DIN VDE 0702:  
 Definition of standards

The sequence of tests is specified in the standard:

9.1 Visual inspection

The test objects are inspected for externally visible defects.

9.2 Measuring the protective conductor resistance  
 (with devices of protection class I)

The limit value is:

0.3  $\Omega$  for devices with connecting cables up to 5 m,  
 plus 0.1  $\Omega$  for every 7.5 m, but a maximum of 1.0  $\Omega$ .

Measuring principle circuit  
 protective conductor resistance PC I, Diagram M1

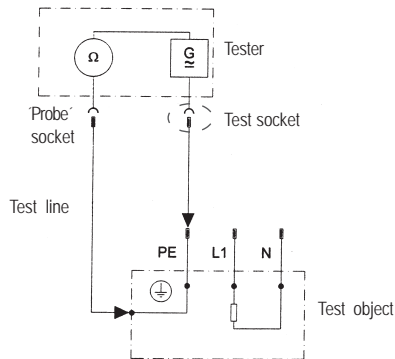

9.3 Measuring insulation resistance

The limit value is:

- 1 M $\Omega$  for devices of protection class I
- 2 M $\Omega$  for devices of protection class II <sup>1)</sup>
- 0.25 M $\Omega$  for devices of protection class III
- 0.3 M $\Omega$  for devices of protection class I with switched-on heating elements <sup>2)</sup>

- <sup>1)</sup> Also applies for touchable conductive parts of test objects in protection class I that are not connected to the protective conductor.
- <sup>2)</sup> If the required insulation resistance is not achieved in the case of test objects in protection class I with heating elements with a total capacity  $\geq 3.5$  kW, the test object is nevertheless rated as faultless if the protective conductor current does not exceed the limit values.

Measuring principle circuit  
 Insulation resistance PC I, Diagram M2

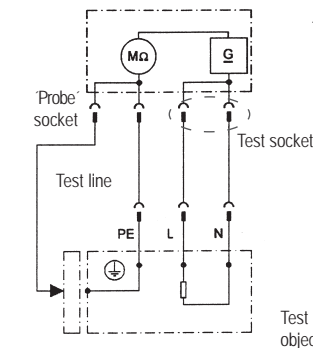

PC II and III, Diagram M3

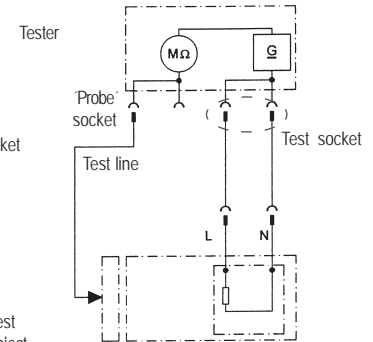

If the insulation measurement is technically impossible, then a protective conductor current measurement (direct or differential current method) must be carried out on test objects in PC I and a touch current measurement on test objects in PC II.

### 9.4a Measuring the protective conductor current

(with devices of protection class I)

The limit value is 3.5 mA.

In the case of test objects with heating elements with a total capacity greater than 3.5 kW, the protective conductor current may not be greater than 1 mA/kW heat output. The protective conductor current can either be measured directly with the substitute leakage current method or with the differential current method.

Measuring principle circuits

Protective conductor current – substitute leakage current method PC I, Diagram M4a

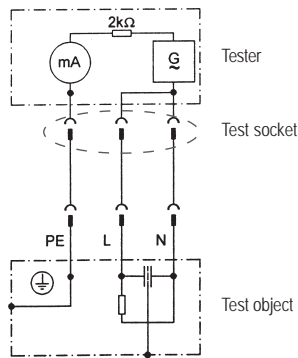

 In case of test objects in PC I with touchable conductive parts that are not connected to the protective conductor, an additional touch current measurement must be carried out in line with PC II (see Diagram 1 on Page 20)



Caution! The test object is supplied with mains voltage during the test.

Protective conductor current - direct measurement PC I, Diagram M5

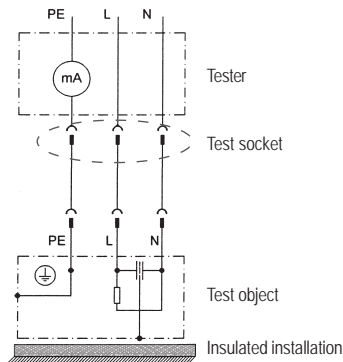

Protective conductor current – differential current method PC I, Diagram M6

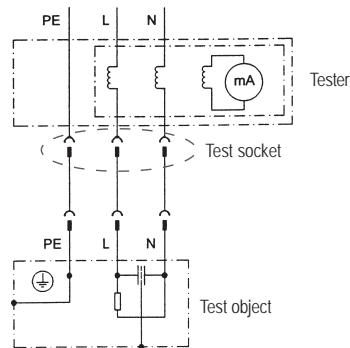

### 9.4b Measuring touch current (with devices of protection class II)

The limit value is 0.5 mA

The touch current can either be measured directly with the substitute leakage current method or with the differential current method. This measurement must also be carried out on devices of protection class I with touchable conductive parts.

Measuring principle circuits  
 Touch current – substitute leakage current method PC II, Diagram M4b

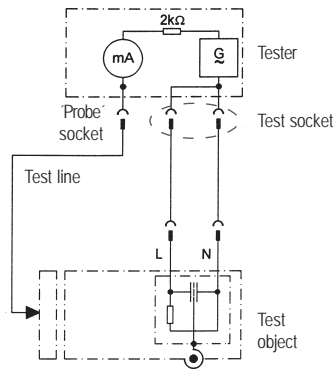

**Caution!** The test object is supplied with mains voltage during the test.

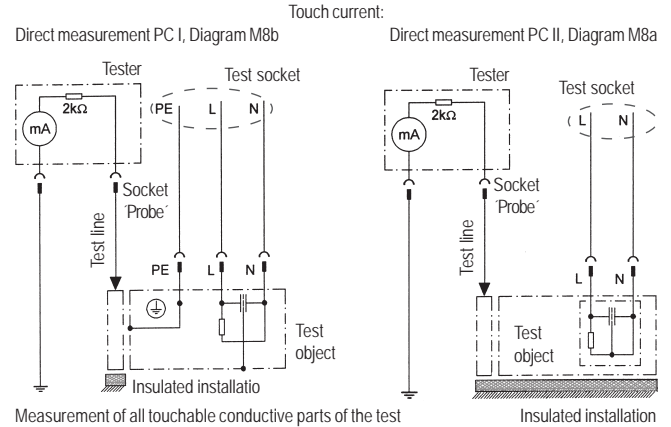

Measurement of all touchable conductive parts of the test object that are not connected to the protective conductor

### 9.5 Inspection the inscriptions

Safety-related inscriptions must be controlled and, where necessary, renewed or supplemented in suitable form.

### 9.6 Function test (only required for DIN VDE 0701)

After completion of the electrical test, a function test shall be carried out on the test object. A partial test can be sufficient.

### 9.7 Documentation

Once a test is passed, it should be documented in suitable form. If a test object proves to be unsafe, this should be clearly indicated on the device and the operator informed in writing. Recording the measured values and the changes is recommended.

9.8 Diagram 1

Test procedure for devices of protection class I

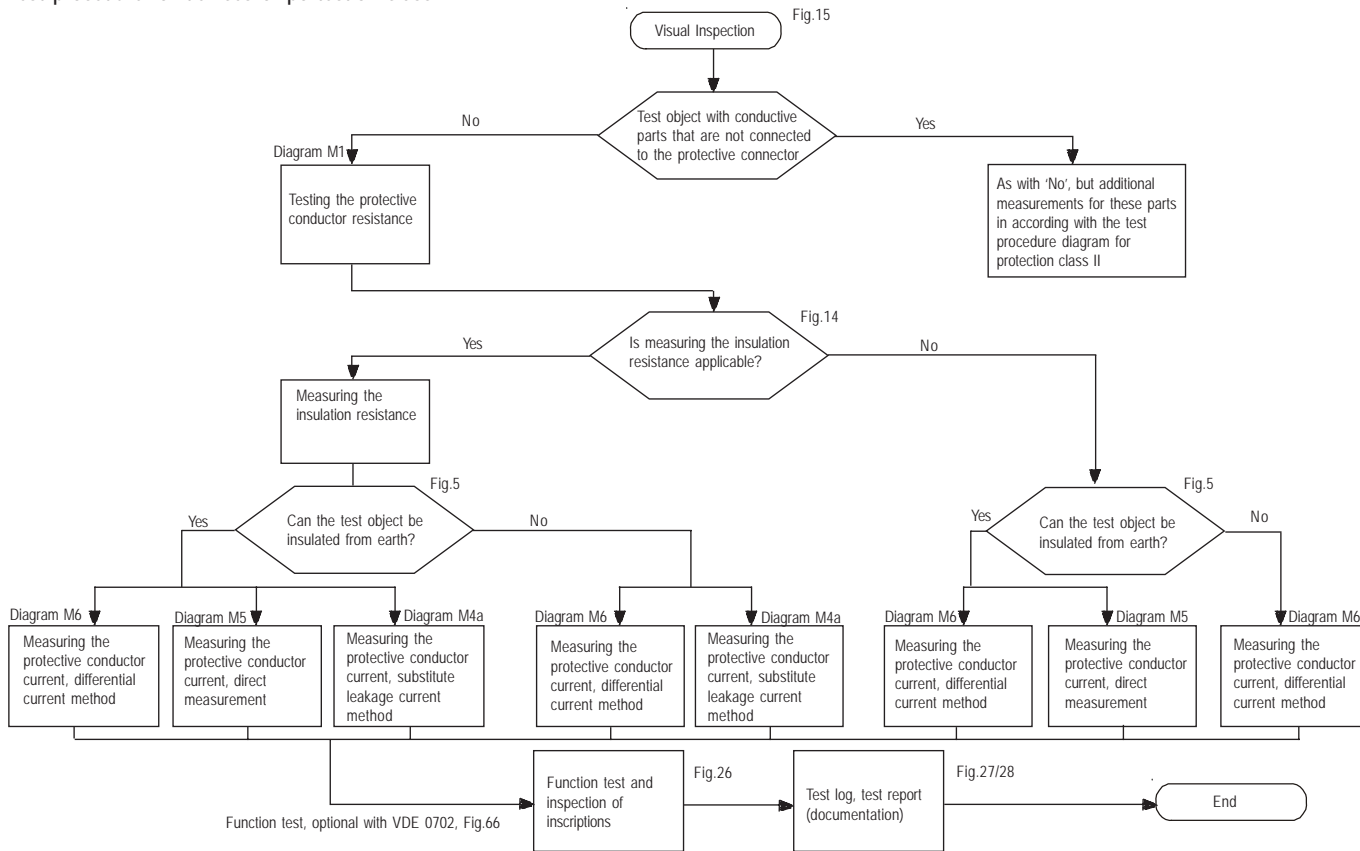

9.9 Diagram 2  
 Test procedure for devices of protection class II and III

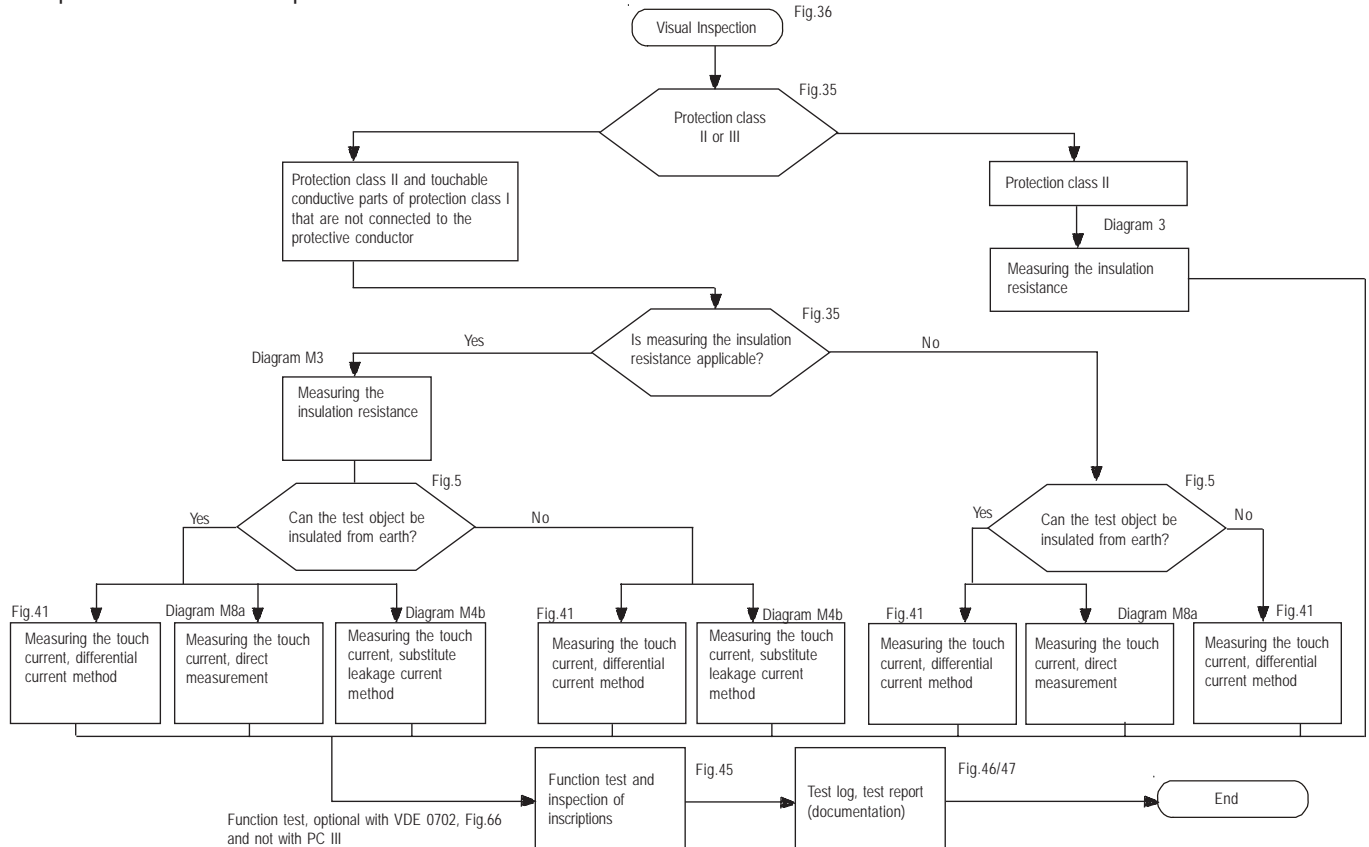

10. Conducting tests with the TG uni 1 appliance tester:  
in accordance with DIN VDE 0701 and DIN VDE 0702, PC I

Connecting the test object

- Connect one end of the test line to the probe socket of the tester.
- Use the crocodile clip to connect the other end of the test line with a metal part of the test object, which is connected to the protective conductor.  
Ensure that the crocodile clip makes a good contact with the metal part of the test object.
- Connect the mains plug of the test object with the test socket of the tester.
- Switch on the test object with the mains switch.

Switching on the appliance tester

Connect the mains plug of the tester to a properly connected and functional earthed mains socket. Switch on the tester with the mains switch. Press the large button in the Switch-on display (Fig. 12).

Entering the test date

The test date is entered or confirmed in the following display (Fig. 12a).

 The tester is not equipped with a real-time clock!

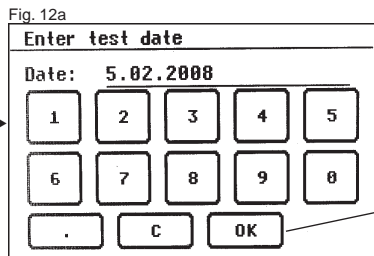
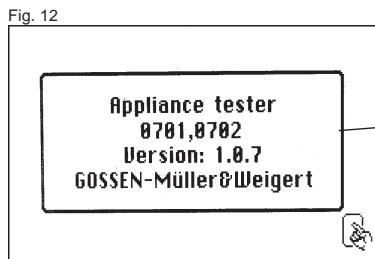

Settings for measuring

Press the function button [Test procedure according to standard] in the 'Main menu' (Fig. 13).

A display with the 'Settings for measuring' appears (Fig. 14). The standard VDE 0701 is preset – change with the [Standard] button.

The protection class is set with the [PC] button (presetting: PC I). Selection of the test procedure – with or without insulation resistance – is specified with the [Ins y/n] button.

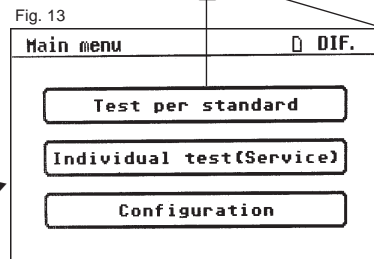
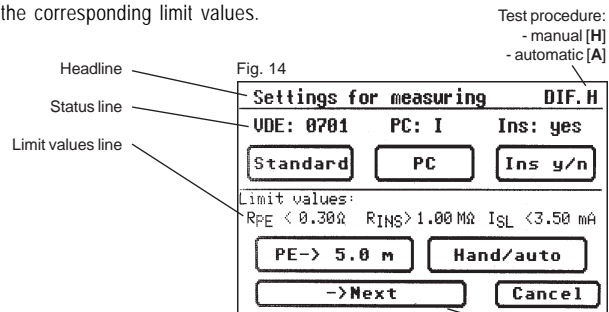

The headline shows the set measuring method for protective conductor current [DIR.] or [DIF.] (see Point 6.3) and the setting for the manual [H] or automatic [A] test procedure. The status line provides information about the current settings throughout the test procedure. In the limit values line you see the corresponding limit values.



The [PE -> 5.0 m] button determines the length of the test object's connecting cable. With every press on this button the value is increased by a further 7.5 m. The resulting limit value for the maximum protective conductor resistance (see below) is visible in the limit values line.

Length of the connecting cable (PE) up to	Limit value for protective conductor resistance ( $R_{PE}$ )
5.0 m	0.3 $\Omega$
12.5 m	0.4 $\Omega$
20 m	0.5 $\Omega$
27.5 m	0.6 $\Omega$
35 m	0.7 $\Omega$
42.5 m	0.8 $\Omega$
50 m	0.9 $\Omega$

With the function button [Hand/Auto] you determine whether the test procedure should be carried out manually (by hand) or automatically.

-  Manual test procedure means that you have to confirm every test stage by pressing the [OK] button to get to the next test stage.
-  Automatic test procedure means that a test stage automatically changes to the next after 5 seconds - except for confirmation of connection to the mains voltage (see Point 6.6, basic settings of the tester).

The headline shows the setting for a manual [H] or automatic [A] test procedure. The [Cancel] button takes you back to the 'Main menu'. To move to the next stage press the [Next] button (also see Diagram 1 in Point 9.8).

-  If in the 'Configuration menu', direct measurement is set as the measuring method for the protective conductor current, the following warning message appears in the display: 'ATTENTION! The test object must be insulated during the following test stages!'. Please follow this instruction without fail; otherwise the protective conductor current cannot be measured correctly.

**10.1 Visual inspection**

The [->Next] button takes you to the first stage of the test: the visual inspection (Fig. 15). The housing, connecting cable, inscriptions and other parts should be inspected in this test. You confirm positive results of the visual inspection by pressing the appropriate buttons - the display changes from 'not OK' to 'OK' (Fig. 16).

**10.2 Protective conductor resistance**

The limit value is:  
0.3  $\Omega$  for devices with connecting cables up to 5 m,  
plus 0.1  $\Omega$  for every 7.5 m, but only up to a maximum of 1.0  $\Omega$   
(see table on Page 22)

Fig. 15

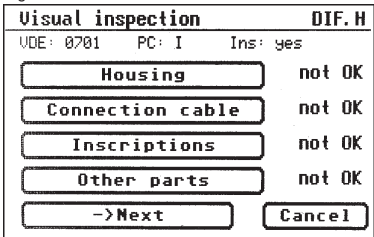

Fig. 16

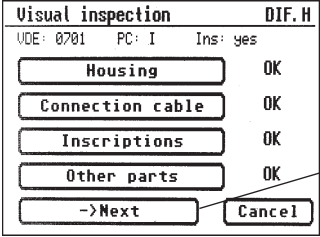
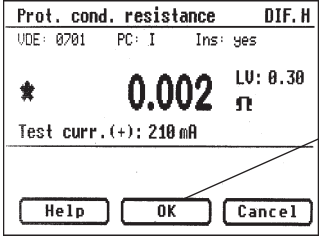

Fig. 17



The [→Next] button takes you to the first electrical test: the protective conductor resistance (Fig. 17).

The measured value appears in the middle of the display in large figures.

- ☞ The star sign on the left side of the display blinks when the measuring process is running (the values are being measured).  
The [OK] button appears when the measured value is determined.

The corresponding limit value LV as well as the instantaneous test current (+) is also displayed.

By pressing the [Help] button you change to the help display for the protective conductor resistance measurement. A measuring principle circuit corresponding to the figure in this operating manual and a short help text are displayed.

After pressing the [End] button you return to the measuring display.

With the manual test procedure the measuring display remains until the [OK] button is pressed. In the next stage the polarity of the test current (-) is reversed and the protective conductor resistance remeasured.

- ☞ During the measurement, the connecting cable of the test object should be moved, section by section, along its whole length, in order to find broken conductors or weak points.

Fig. 18

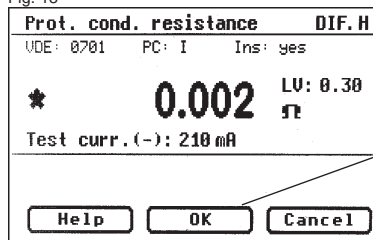

Fig. 19

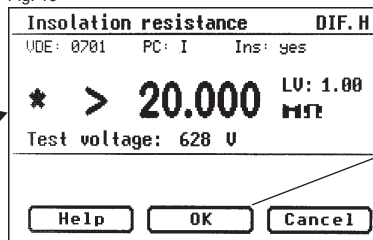
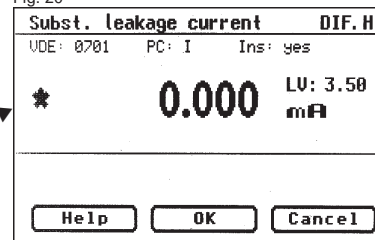

Fig. 20



### 10.3 Insulation resistance (compare with Point 10.4a)

The limit value is:

1.0 MΩ (PC I)

2.0 MΩ for touchable conductive parts that are not connected to the protective conductor (PC I).

0.3 MΩ for devices of PC I with switched-on heating elements  $\geq 3.5$  kW \*)

\*) If the required insulation resistance is not achieved in the case of devices in protection class I with heating elements with a total capacity of 3.5 kW, the device is nevertheless rated as faultless if the protective conductor current does not exceed the limit values. (tester setting – PC: Ie).

If you have selected a test procedure **with insulation resistance** in the 'Settings for measuring', the measuring display for the insulation resistance measurement (Fig. 19) appears after you press the [OK] button. Beside the measured value, the level of the test voltage is also displayed (min. 500 V DC).

- ☞ The star sign on the left side of the display blinks when the measuring process is running (the values are being measured).  
The [OK] button appears when the measured value is determined.

A help display with a measuring principle circuit and a help text is also available here.



#### 10.4a Protective conductor current (substitute leakage current)

The limit value is:  
3.5 mA (PC I)

In the case of devices with heating elements with a total capacity greater than 3.5 kW, the protective conductor current may not be greater than 1 mA/kW heat output.

The [OK] button takes you further to the measuring display 'Protective conductor current' (according to the substitute leakage current principle). Here, too, the related limit value is displayed beside the measured value (Fig. 20).

#### Warning!

With the test procedure according to DIN VDE 0702 and a test with insulation resistance, the protective conductor current is always measured by the tester with connection to the mains voltage (direct method or according to the differential current principle).

#### 10.4b Protective conductor current (compare with Point 10.4a)

The limit value is:  
3.5 mA (PC I)

In the case of devices with heating elements with a total capacity greater than 3.5 kW, the protective conductor current may not be greater than 1 mA/kW heat output.

If you have selected a test procedure **without insulation resistance** in the 'Settings for measuring', the tester changes to measuring the protective conductor current (Points 3. – Insulation resistance and 4a. – Substitute leakage current, are omitted).



**Caution!** The test object is supplied with mains voltage during the test.

After pressing the [OK] button you will see a warning about connection to the mains current (Fig. 21).

Fig. 21



Fig. 22

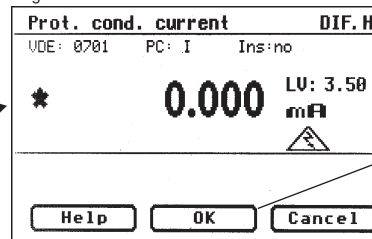
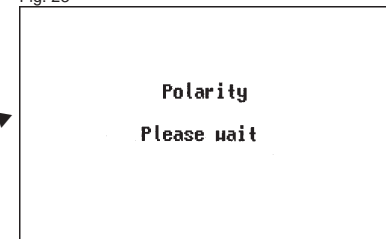

Fig. 23



With your assent – by pressing the large button – the display changes to measuring the protective conductor current and the mains voltage is connected – **the test object is put into operation!**

You can see the measured value in the middle of the display, with the related limit value to the right (Fig. 22).

- ☞ The star sign on the left side of the display blinks when the measuring process is running (the values are being measured).  
The [OK] button appears when the measured value is determined.

The symbol ⚠ blinks to indicate the connection to the mains voltage.

With the [Help] button, you can also go to the help display from here.

Pressing the [OK] button automatically **reverses the polarity** of the mains plug of the test object (Fig. 23).

A compulsory break of 8 seconds serves to halt any running motors. Thereafter, you are again warned about connection to the mains voltage. After confirmation with the [OK] button, the mains voltage is reconnected and the measurement of the protective conductor current repeated (Fig. 21 and 22).

- ☞ Selecting the measuring method for protective conductor current - see Point 6.3 Setting the measuring method for protective conductor current measurement.

### 10.5 Function test (only required for DIN VDE 0701)

Press the [OK] button to go to the menu 'Function test' menu.

Here a function test of the test object is carried out in accordance with DIN VDE 0701 (Fig. 24).



**Caution! The test object is supplied with mains voltage during the test.**

Before connection is made to the mains voltage a warning message appears in the display. The automatic test procedure is stopped; it only proceeds when a button is pressed (Fig. 25).

After you have confirmed the connection of the mains voltage by pressing the button, the tester changes to the function test display (Fig. 26).

The display shows the instantaneous mains voltage, the load current, the active power, apparent power and reactive power, the power factor and mains frequency.

### 10.6 Inspecting the inscriptions

At this point the values displayed in the function test should be compared with the data on the type plate of the test object.

Fig. 24

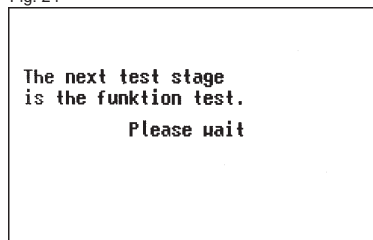
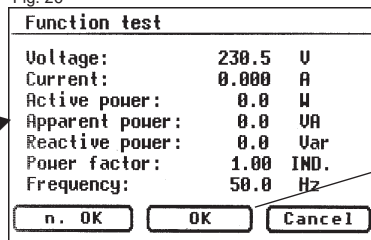

Fig. 25



Fig. 26



## 10.7 Documentation

After pressing the [OK] button, the display changes to the 'Test result' screen (Fig. 27).

Here you can see all the measurement results with the related limit values.

If the measurement results of the electrical values, the visual inspection and the function test were all in order, the following message appears:

'Test OK'.

If the test was not successful the message says:

'Test not OK!'.

At this point you can cancel the test with the [Cancel] button (the display goes back to the 'Settings for measuring' screen) or switch to the 'Memory menu' with the [->Next] button.

In the 'Memory menu' (Fig. 28) you can use the function button [Change memory] to switch the storage location for measurement results between the device-internal memory and the MMC memory card.

The current setting is shown in the menu headline.

With the [Save] button the display changes to 'Enter appliance identification'. Here you can enter a max. 10-character test object ID number or read it in from the barcode label with the optionally available barcode scanner (Fig. 29).

 The barcode scanner is connected to the RS232 socket of the tester

Fig. 27

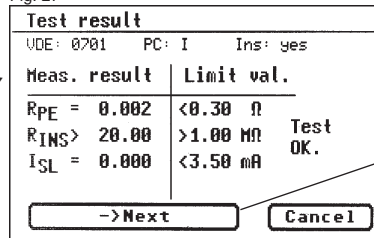
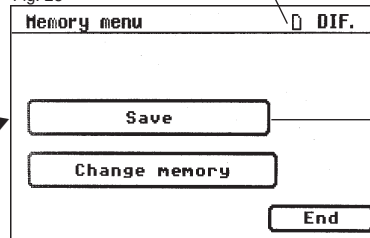

Fig. 28



Symbols for memory settings:



- internal memory



- MMC memory card

Fig. 29

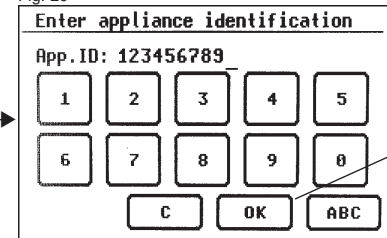

## Operating manual for the TG uni 1 appliance tester

Conducting tests in accordance with VDE 0701 and 0702 - PC I

Confirm the entry with the [OK] button – the display changes (Fig. 30) and shows the ID number, the name of the inspector and the date (see Points 6.4 and 6.7 for entering the inspector's name and the date). The data is saved in the memory with the [Save] button.

A confirmation message appears (Fig. 31) – continue with the [End] button.

With the entry of an already used ID number, the data is „attached“ as a new test to this ID number.

After the saving process, the display changes to the 'Settings for measuring' menu – the tester is ready for the next test (Fig. 32).

The test results can be saved on a PC with the supplied PC programme or printed from there in the form of a test log. To do this, make the USB connection between the tester and the PC (USB cable supplied with the tester) or transfer the saved data from the MMC memory card to the PC.

Procedure on the PC – see the operating instructions for the PC software.

### General information

Every test stage during which the test object is supplied with mains voltage is time limited for reasons of safety! The maximum duration of this test stage is approx. 4 minutes. After this time has expired a message appears in display. At this point you can continue the test with the [->Next] button or cancel it with the [Cancel] button.

Fig. 30

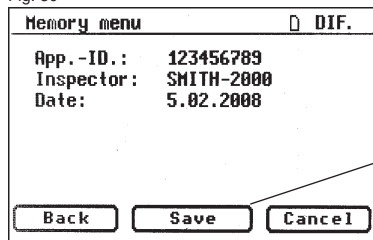

Fig. 31

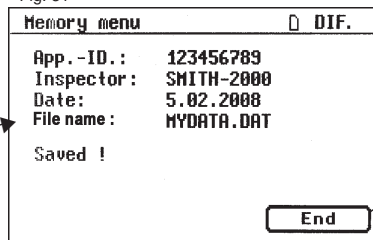
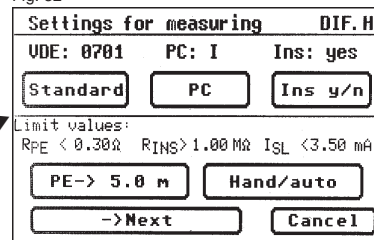

Fig. 32



## 11. Conducting tests with the TG uni 1 appliance tester: in accordance with DIN VDE 0701 and DIN VDE 0702, PC II

### Connecting the test object

- Connect one end of the test line to the probe socket of the tester.
- Use the crocodile clip to connect the other end of the test line with a touchable metal part of the housing of the test object.  
 Ensure that the crocodile clip makes a good contact with the metal part of the test object.
- Connect the mains plug of the test object with the test socket of the tester.
- Switch on the test object with the mains switch.

### Switching on the appliance tester

Connect the mains plug of the tester to a properly connected and functional earthed mains socket. Switch on the tester with the mains switch. Press the large button in the Switch-on display (Fig. 33).

### Entering the test date

The test date is entered or confirmed in the following display (Fig. 33a).

- 🔒 The tester is not equipped with a real-time clock!

Fig. 33



Fig. 33a

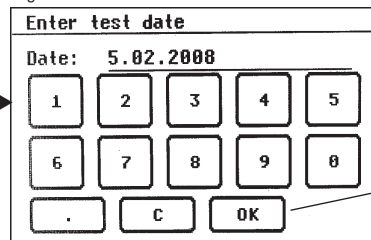

### Settings for measuring

Press the function button [Test procedure according to standard] in the Main menu (Fig. 34).

A display with the 'Settings for measuring' appears (Fig. 35).

The standard VDE 0701 is preset – change with the [Standard] button. The protection class is set with the [PC] button (Presetting: PC I). Press the [PC] button to change the setting to protection class II. Selection of the test procedure – with or without insulation resistance – is specified with the [Ins y/n] button.

The headline shows the set measuring method for touch current [DIR.] or [DIF.] (see 'Configuration menu' Point 6.3) and the setting for the manual [H] or automatic [A] test procedure.

The status line provides information about the current settings throughout the test procedure.

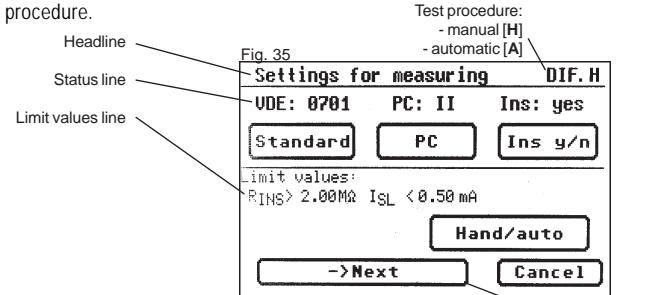
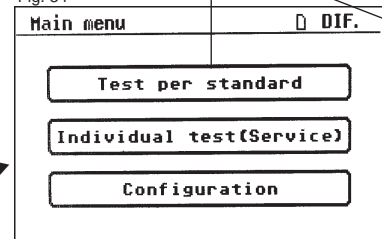



Fig. 34



The corresponding limit values are given in the limit values line.  
 With the function button [Hand/Auto] you determine whether the test procedure should be carried out manually (by hand) or automatically.

-  Manual test procedure means that you have to confirm every test stage by pressing the [OK] button to get to the next test stage.
-  Automatic test procedure means that a test stage automatically changes to the next after 5 seconds - except for confirmation of connection to the mains voltage (see Point 6.6, basic settings of the tester)

The [Cancel] button takes you back to the 'Main menu'.

To move to the next stage press the [->Next] button (also see Diagram 2 in Point 9.9).

-  If, in the Configuration menu, direct measurement is set as the measuring method for the protective conductor current/ touch current (Point 6.3), the following warning message appears in the display:  
**'ATTENTION! The test object must be insulated during the following test stages!'**  
 Please follow this instruction without fail; otherwise the touch current cannot be measured correctly.

### 11.1 Visual inspection

The [->Next] button takes you to the first stage of the test, the visual inspection (Fig. 36).

The housing, connecting cable, inscriptions and other parts should be inspected in this test. You confirm positive results of the visual inspection by pressing the appropriate buttons – the display changes from 'not OK' to 'OK' (Fig. 37).

### 11.2 Insulation resistance (compare with Point 11.3b)

The limit value is:  
 2.0 MΩ (SK II) \*)

\*) Also applies for touchable conductive parts of devices in protection class I that are not connected to the protective conductor.

If you have selected a test procedure **with insulation resistance** in the 'Settings for measuring', the measuring display for insulation resistance measurement (Fig. 38) appears after you press the [->Next] button. Beside the measured value, the level of the test voltage is also displayed (min. 500 V DC).

-  The star sign on the left side of the display blinks when the measuring process is running (the values are being measured). The [OK] button appears when the measured value is determined.

By pressing the [Help] button you go to a help display with the measuring principle circuit and a help text.

Fig. 36

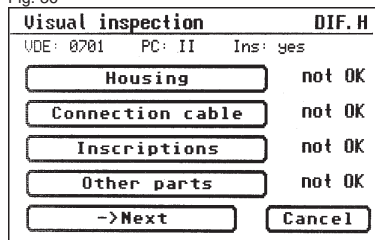

Figb. 37

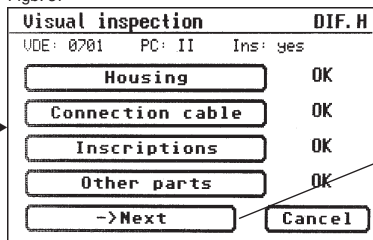
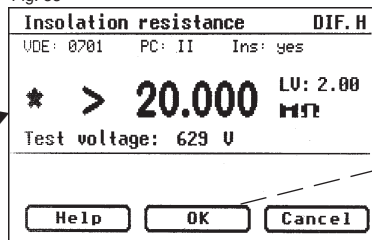

Fig. 38



### 11.3a Touch current (substitute leakage current)

The limit value is:  
0.5 mA

This measurement must also be carried out on devices of protection class I with touchable conductive parts that are not connected to the protective conductor.

Press the [OK] button to go to the 'Touch current' measuring display. The measurement is made in accordance with the substitute leakage current principle.

Here, too, the corresponding limit value is displayed beside the measured value (Fig. 39).

- ☞ The star sign on the left side of the display blinks when the measuring process is running (the values are being measured). The [OK] button appears when the measured value is determined.

A help display is also available if you press the [Help] button.

#### Warning!

With the test procedure according to DIN VDE 0702 and a test with insulation resistance, the touch current is always measured by the tester with connection to the mains voltage (direct method or according to the differential current principle).

Fig. 39

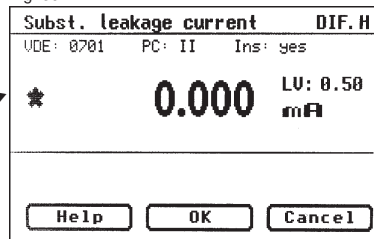

### 11.3b Touch current (compare with Point 11.2)

The limit value is:  
0.5 mA

This measurement must also be carried out on devices of protection class I with touchable conductive parts that are not connected to the protective conductor.

If you have selected a test procedure **without insulation resistance** in the 'Settings for measuring', the tester changes to measuring the touch current (Points 11.2. Insulation resistance and 11.3a. Touch current / Substitute leakage current, are omitted)

 **Caution! The test object is supplied with mains voltage during the test.**

After pressing the [->Next] button the display changes and you receive a warning message about the connection to the mains current (Fig. 40). With your assent – by pressing the large button – the display changes to measuring the touch current and the mains voltage is connected – **the test object is put into operation!**

You can see the measured value in the middle of the display, with the related limit value to the right (Fig. 41).

Fig. 40



Fig. 41

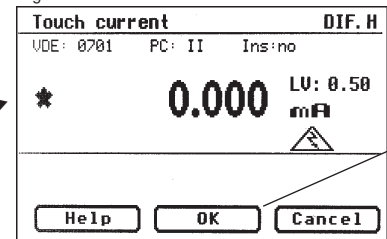

- ☞ The star sign on the left side of the display blinks when the measuring process is running (the values are being measured). The [OK] button appears when the measured value is determined.

The symbol  blinks to indicate the connection to the mains voltage.

With the [Help] button, you can also go to the help display from here.

Pressing the [OK] button automatically **reverses the polarity** of the mains plug of the test object (Fig. 42).

A compulsory break of 8 seconds serves to halt any running motors. Thereafter, you are again warned about the connection to the mains voltage. After confirmation by pressing the button, the mains voltage is reconnected and the measurement of the touch current repeated (Fig. 40 and 41).

- ☞ Selecting the measuring method for touch current - see Point 6.3, Setting the measuring process for protective conductor current measurement.

#### 11.4 Function test (only required for DIN VDE 0701)

Press the [OK] button to go to the function test.

Here a function test of the test object is carried out in accordance with DIN VDE 0701 (Fig. 43).

 **Caution! The test object is supplied with mains voltage during the function test.**

Before connection is made to the mains voltage a warning message appears in the display. The automatic test procedure is stopped; it only proceeds when a button is pressed (Fig. 44).

After you have confirmed the connection of the mains voltage by pressing the button, the tester changes to the function test display (Fig. 45).

The display shows the instantaneous mains voltage, the load current, the active power, apparent power and reactive power, the power factor and mains frequency.

#### 11.5 Inspecting the inscriptions

At this point the values displayed in the function test should be compared with the data on the type plate of the test object.

Fig. 42

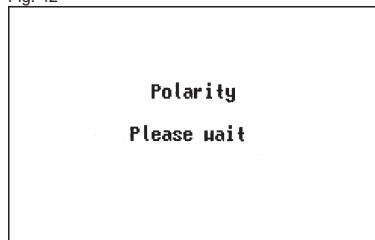

Fig. 43

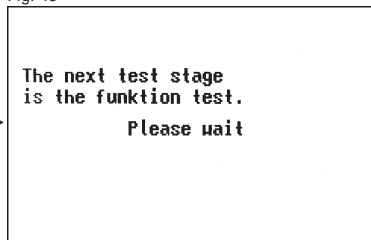

Fig. 44





### 11.6 Documentation

After pressing the [OK] button, the display changes to the 'Test result' screen. Here you can see all the measurement results with the related limit values (Fig. 46).

If the measurement results of the electrical values, the visual inspection and the function test were all in order, the following message appears: 'Test OK'. If the test was not successful the message says: 'Test not OK!'.

At this point you can cancel the test with the [Cancel] button (the display goes back to the 'Settings for measuring' screen) or switch to the 'Memory menu' with the [->Next] button.

In the 'Memory menu' you can use the function button [Change memory] to switch the storage location for measurement results between the device-internal memory and the MMC memory card. The current setting is shown in the menu headline (Fig. 47).

With the [Save] button the display changes to 'Enter appliance identification'. Here you can enter a 10-character test object ID number or read it in from the barcode label with the connected barcode scanner.

👉 Connecting the barcode scanner – see Page 27.

Fig. 45

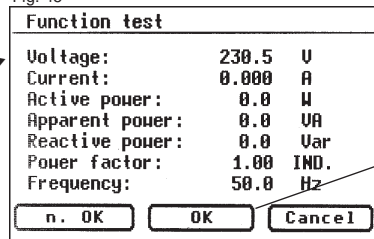
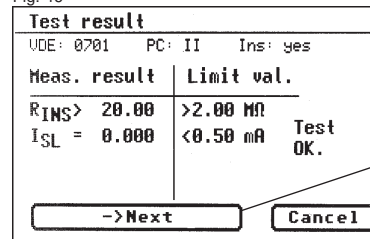

Fig. 46



Symbols for die memory settings:

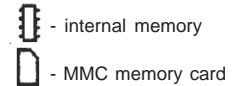
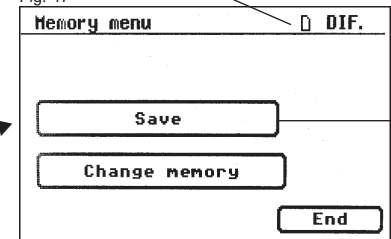

Fig. 47



## Operating manual for the TG uni 1 appliance tester

Conducting tests in accordance with VDE 0701 and 0702 - PC II

Confirm the entry with the [OK] button – the display changes (Fig. 49) and shows the ID number, the name of the inspector and the date (see Points 6.4 and 6.7 for entering the inspector's name and the date). The data is saved in the memory with the [Save] button.

A confirmation message appears (Fig. 50) – continue with the [End] button.

☞ With the entry of an already used ID number, the data is "attached" as a new test to this ID number.

After the saving process, the display changes to the 'Settings for measuring' menu – the tester is ready for the next test.

The test results can be saved on a PC with the supplied PC programme or printed from there in the form of a test log. To do this, make the USB connection between the tester and the PC (USB cable supplied with the tester) or transfer the saved data from the MMC memory card to the PC.

Procedure on the PC – see the operating instructions for the supplied PC software.

### General information

Every test stage during which the test object is supplied with mains voltage is time limited for reasons of safety!

The maximum duration of this test stage is approx. 4 minutes. A warning message then appears in display.

At this point you can continue the test with the [->Next] button or cancel it with the [Cancel] button.

Fig. 48

Enter appliance identification

App. ID: 123456789

1	2	3	4	5
6	7	8	9	0
C		OK	ABC	

Fig. 49

Memory menu DIF.

App.-ID.: 123456789  
Inspector: SMITH-2000  
Date: 5.02.2008

Back Save Cancel

Fig. 50

Memory menu DIF.

App.-ID.: 123456789  
Inspector: SMITH-2000  
Date: 5.02.2008  
File name: HYDATA.DAT

Saved !

End

**12. Conducting tests with the TG uni 1 appliance tester: in accordance with DIN VDE 0701 and DIN VDE 0702, PC III**

**Connecting the test object**

- Connect one end of the test line to the probe socket of the tester.
- Use the crocodile clip to connect the other end of the test line with a touchable metal part of the housing of the test object. Ensure that the crocodile clip makes a good contact with the metal part of the test object.
- Connect the low voltage connection of the test object with the test socket of the tester (see Diagram M3 on page 17).
- Switch the test object on.

**Switching on the appliance tester**

Connect the mains plug of the tester to a properly connected and functional earthed mains socket. Switch on the tester with the mains switch. Press the large button in the Switch-on display (Fig. 51).

**Entering the test date**

The test date is entered or confirmed in the following display (Fig. 51a).

The tester is **not** equipped with a real-time clock!

Fig. 51

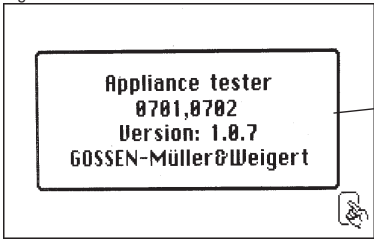
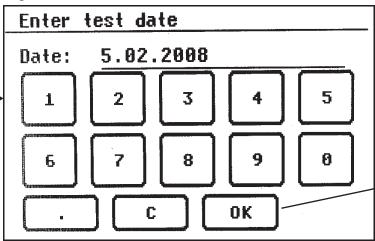

Fig. 51a



**Settings for measuring**

Press the function button [Test procedure according to standard] in the Main menu (Fig. 52).

A display with the 'Settings for measuring' appears (Fig. 53). The standard VDE 0701 is preset – change with the [Standard] button. The protection class is set with the [PC] button. Press the [PC] button to change the setting to protection class III. The headline shows the setting for a manual [H] or automatic [A] test procedure.

The status line provides information about the current settings throughout the test procedure. In the limit value line you now see the corresponding limit value of the insulation resistance.

With the function button [Hand/Auto] you determine whether the test procedure should be carried out manually (by hand) or automatically.

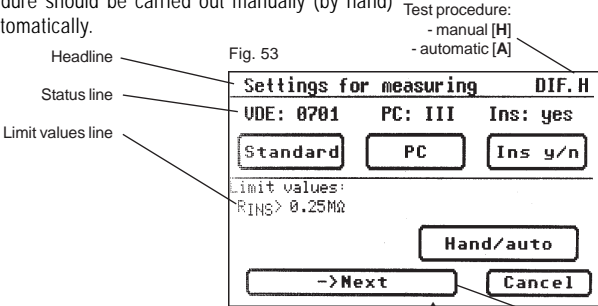
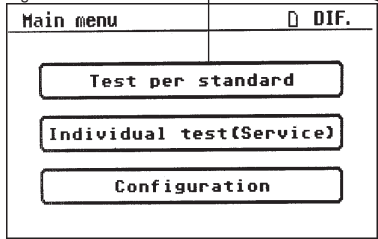

Fig. 53

Fig. 52



- ☞ Manual test procedure means that you have to confirm every test stage by pressing the [OK] button to get to the next test stage.
- ☞ Automatic test procedure means that a test stage automatically changes to the next after 5 seconds - except for confirmation of connection to the mains voltage (see Point 6.6, basic settings of the tester)

The [Cancel] button takes you back to the 'Main menu'.

- ☞ To move to the next stage - also see Diagram 2 in Point 9.9.

### 12.1 Visual inspection

The [->Next] button takes you to the first stage of the test, the visual inspection (Fig. 54).

The housing, connecting cable, inscriptions and other parts should be inspected in this test.

You confirm positive results of the visual inspection by pressing the appropriate buttons – the display changes from 'not OK' to 'OK' (Fig. 55).

Fig. 54

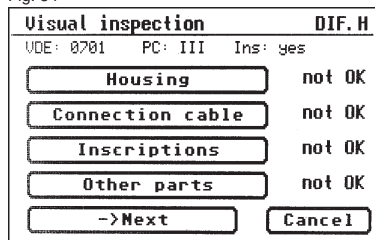

Fig. 55

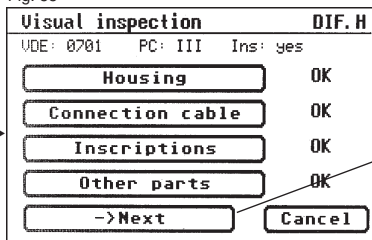
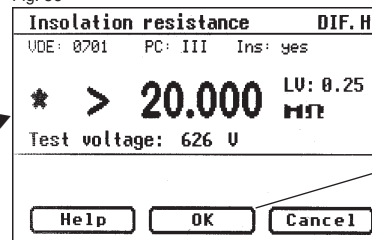

Fig. 56



### 12.2 Insulation resistance

The limit value is:  
0.25 MΩ (PC III)

After pressing the [->Next] button, the display for the insulation resistance measurement appears (Fig. 56).

Beside the measured value, the level of the test voltage is also displayed (min. 500 V DC).

- ☞ The star sign on the left side of the display blinks when the measuring process is running (the values are being measured). The [OK] button appears when the measured value is determined.

A help display with a measuring principle circuit and a help text is also available here.

- ☞ Since the tester cannot provide the specific low voltage for the test object, a function test is not carried out for test objects in PC III. Alternatively, the test object can be tested according to PC II with the appropriate power supply unit - see Point 11 on Page 29.

### 12.3 Documentation

After pressing the [OK] button, the display changes to the 'Test result' screen (Fig. 57).

Here you can see all the measurement results with the related limit values.

If the measurement results of the electrical values, the visual inspection and the function test were all in order, the following message appears:

'Test OK'.

If the test was not successful the message says:

'Test not OK!'.

At this point you can cancel the test with the [Cancel] button (the display goes back to the 'Settings for measuring' screen) or switch to the 'Memory menu' with the [->Next] button.

In the 'Memory menu' you can use the function button [Change memory] to switch the storage location for measurement results between the device-internal memory and the MMC memory card. The current setting is shown in the menu headline (Fig. 58).

With the [Save] button the display changes to 'Enter appliance identification'. Here you can enter a 10-character test object ID number or read it in from the barcode label with the connected barcode scanner (Abb. 59).

👉 Connecting the barcode scanner - see Page 27.

Fig. 57

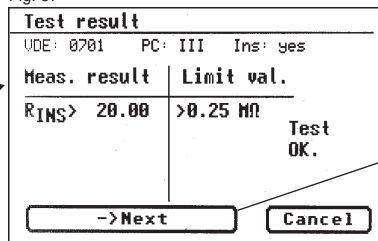
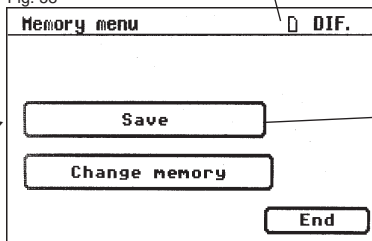

Fig. 58



Symbols for memory settings:



- internal memory



- MMC memory card

Fig. 59

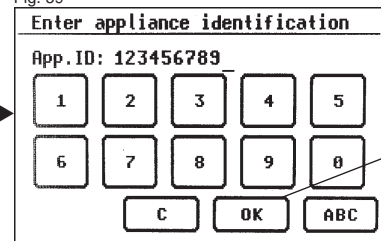

## Operating manual for the TG uni 1 appliance tester

Conducting tests in accordance with VDE 0701 and 0702 - PC III

Confirm the entry with the [OK] button – the display changes (Fig. 60) and shows the ID number, the name of the inspector and the date. The data is saved in the memory with the [Save] button.

A confirmation message appears (Fig. 61) – continue with the [End] button.

 With the entry of an already used ID number, the data is "attached" as a new test to this ID number

After the saving process, the display changes to the 'Settings for measuring' menu – the tester is ready for the next test (Fig. 62).

The test results can be saved on a PC with the supplied PC programme or printed from there in the form of a test log. To do this, make the USB connection between the tester and the PC (USB cable supplied with the tester) or transfer the saved data from the MMC memory card to the PC.

Procedure on the PC – see the operating instructions for the supplied PC software.

Fig. 60

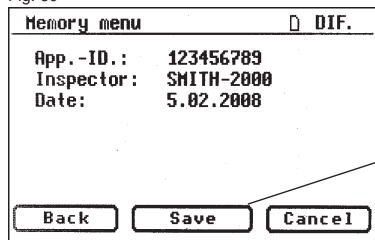

Memory menu		DIF.
App.-ID.:	123456789	
Inspector:	SMITH-2000	
Date:	5.02.2008	
Back		Save
Cancel		

Fig. 61

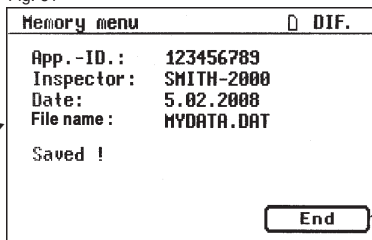

Memory menu		DIF.
App.-ID.:	123456789	
Inspector:	SMITH-2000	
Date:	5.02.2008	
File name:	MYDATA.DAT	
Saved !		
End		

Fig. 62

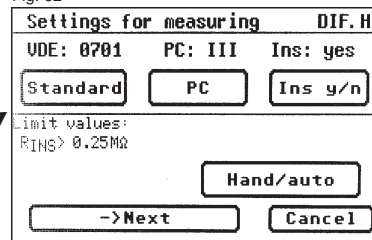

Settings for measuring			DIF.H
VDE: 0701	PC: III	Ins: yes	
Standard	PC	Ins y/n	
Limit values:			
RINS > 0.25MΩ			
Hand/auto			
->Next		Cancel	

13. **Conducting tests with the appliance tester TG uni 1:  
in accordance with DIN VDE 0702, all protection classes**

The function test is not expressly required in the standard DIN VDE 0702.

With every test procedure carried out according to DIN VDE 0702, the tester offers the function test as an option (also see Points 9.8 and 9.9).

A display offering this option appears at the appropriate point.  
(Fig. 63)

Fig. 63

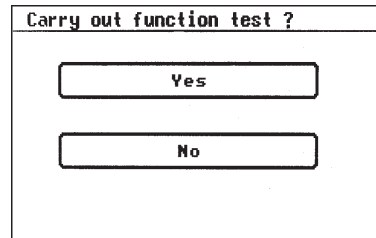

- ☞ With the exception of the function test, the test procedure according to DIN VDE 0702 is essentially identical with the test procedure according to DIN VDE 0701.

14. Conducting tests with the appliance tester TG uni 1 in accordance with DIN VDE 0701 and DIN VDE 0702 – special test procedure according to customer-specific settings

- 🔒 This input area is locked by a code key.  
Please contact us for further information:  
Tel. +49 (0)911 / 3502-0, Fax +49 (0)911 / 3502-307.

If several tests should be carried out with an identical setting of the tester, the tester can be „pre-programmed“ for a test series – according to VDE 0701 or 0702 (also see Point 6.8).  
In the following example the tester is set for the test according to DIN VDE 0702 (periodic inspection), differential current measuring method, PC I and without insulation resistance.

The settings are entered in Setup in the Configuration menu, see Fig. 64 to Fig. 75.

Fig. 64

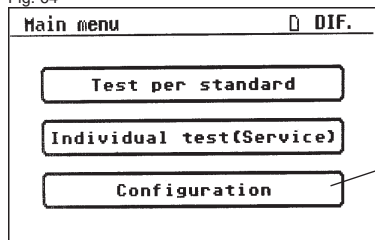

Fig. 65

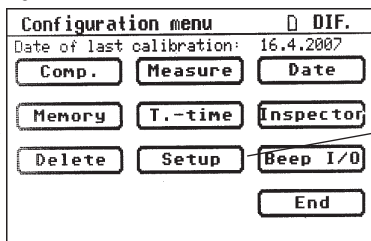

Fig. 66

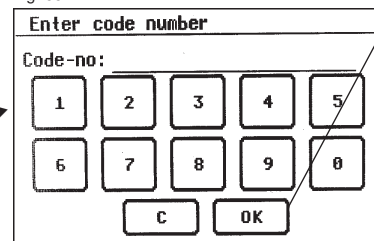



Fig. 67

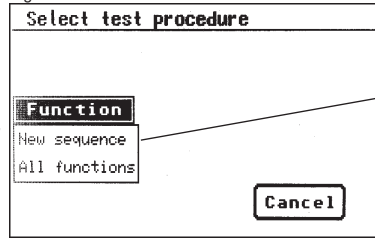

Fig. 68

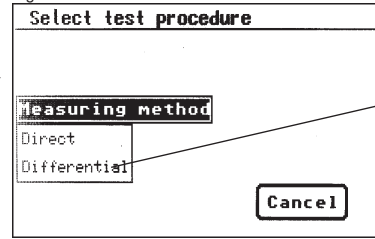

Fig. 69

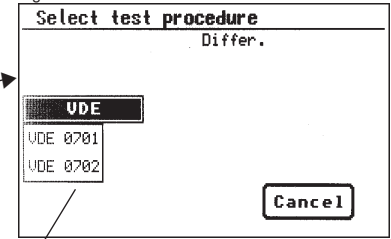

Fig. 70

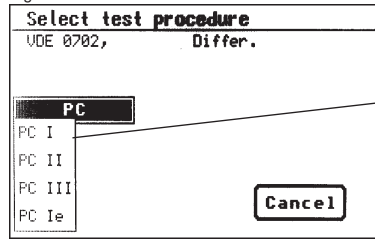

Fig. 71

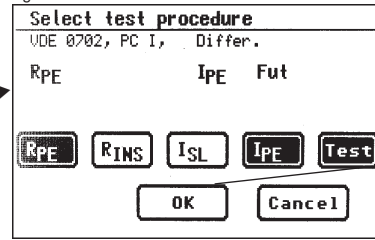
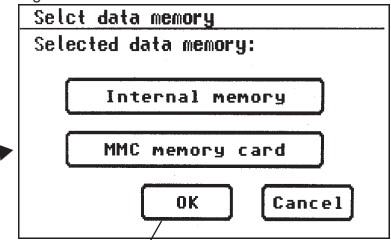

Fig. 72



The tester is now ready to start new tests

Fig. 73

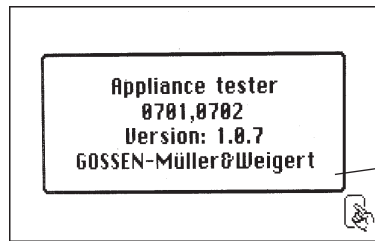

Fig. 74

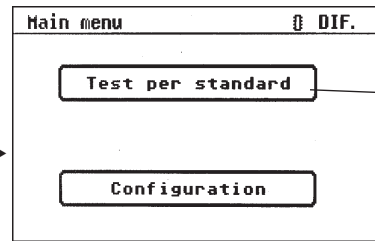
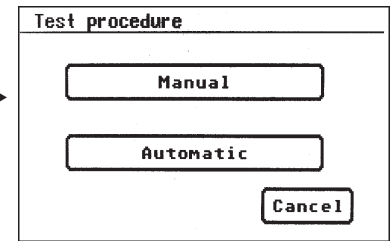

Fig. 75



## 15. Technical data

### Protective conductor resistance:

Measuring range	0 ... 2 $\Omega$
Display range	0 ... 1.000 $\Omega$
Resolution	1 m $\Omega$
Error	$\pm 5\% \pm 10$ digit
Measurement current	min. 200 mA DC (+/-)

### Insulation resistance:

Measuring range	200 k $\Omega$ ... 200 M $\Omega$
Display range	0.200 ... 200 M $\Omega$
Resolution	0.001 k $\Omega$
Error	$\pm 5\% \pm 10$ digit
Measurement voltage	min. 500 V DC

### Substitute leakage current:

Measuring range	0 ... 20 mA
Display range	0 ... 20 mA
Resolution	0,001 mA
Error	$\pm 5\% \pm 10$ digit
Measurement voltage	220 V AC

### Protective conductor current, direct:

Measuring range	0 ... 5 mA
Display range	0 ... 5 mA
Resolution	0.001 mA
Error	$\pm 5\% \pm 10$ digit

### Touch current, direct:

Measuring range	0 ... 1 mA
Display range	0 ... 1 mA
Resolution	0.001 mA
Error	$\pm 5\% \pm 10$ digit

### Protective conductor current, differential current:

Measuring range	0 ... 5 mA
Display range	0 ... 5 mA
Resolution	0.001 mA
Error	$\pm 5\% \pm 10$ digit

### Touch current, differential current:

Measuring range	0 ... 1 mA
Display range	0 ... 1 mA
Resolution	0.001 mA
Error	$\pm 5\% \pm 10$ digit

**15.1 Technical data for function tests****Voltage:**

Measuring range	190 ... 250 V
Display range	190.0 ... 250.0 V
Resolution	0.1 V
Error	± 1 % ± 5 digit

**Current:**

Measuring range	0 ... 16 A
Display range	0 ... 16.00 A
Resolution	0.001 mA
Error	± 2 % ± 10 digit

**Active power:**

Measuring range	0 ... 3700 W
Display range	0 ... 3700 W
Resolution	100 mW
Error	± 2 % ± 10 digit

**Reactive power:**

Measuring range	0 ... 3700 Var
Display range	0 ... 3700 Var
Resolution	100 mVAr
Error	± 2 % ± 10 digit

**Apparent power:**

Measuring range	0 ... 3700 VA
Display range	0 ... 3700 VA
Resolution	100 mVA
Error	± 2 % ± 10 digit

**Power factor:**

Measuring range	0 cap. ... 1 ... 0 ind.
Display range	0.00 cap. ... 1 ... 0.00 ind.
Resolution	0.01
Error	± 3 %

**Frequency:**

Measuring range	40 ... 50 ... 60 Hz
Display range	40.0 ... 50.0 ... 60.0 Hz
Resolution	0.1 Hz
Error	± 3 %

**15.2 General technical data**

Internal memory capacity	16 MB
MMC memory card capacity	128 bis 256 MB
Serial interfaces	9600 baud, no parity, 1 stopp bit
USB connection	USB 1.1
Power supply	230 V AC, 50 Hz, approx. 10 VA
Degree of pollution	2
Overvoltage category	CAT II 300 V
Electrical safety	according to EN61010-1 / VDE 0411
EMC	
Emitted interference	according to EN 55011
Interference resistance	according to EN 61000-4-2
Dimensions approx.	300 x 250 x 130 mm (W x D x H)
Weight approx.	3.1 kg (incl. accessories)

Optional barcode scanner with serial interface (9-pin Sub-D) and internal power supply via pin 9.

## 16. Manufacturer's guarantee conditions

The TG uni 1 appliance tester is subject to a strict quality inspection. Nevertheless, we grant a 24 month manufacturer's guarantee in the case of malfunctions during normal daily usage. Manufacturing or material faults will be remedied, free of charge, as long as the device shows no signs of third party actions and is unopened before it is sent back to us. Damage resulting from the device being dropped or mishandled is excluded from guarantee claims.

**GOSSEN Müller & Weigert**  
Kleinreuther Weg 88  
D-90408 Nürnberg, Germany  
Tel. +49(0)911 3502-0  
Fax +49(0)911 3502-307  
info@g-mw.de · www.g-mw.de

