



Manual for connection and operation of

EASYBus-control, display and supervisory device

EB 3000

as of Version 1.7

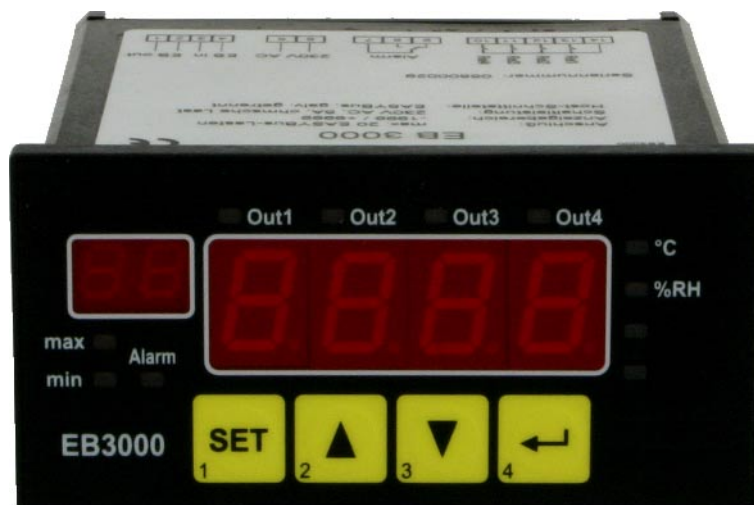

GREISINGER electronic GmbH

D - 93128 Regenstauf, Hans-Sachs-Straße 26

Tel.: 09402 / 9383-0, Fax: 09402 / 9383-33, e-mail: info@greisinger.de

INDEX

1. SAFETY REGULATIONS	3
2. INTRODUCTION	4
2.1. EASYBUS -terms and definitions	4
3. DISPLAY ELEMENTS AND PUSHBUTTONS	5
4. ELECTRIC CONNECTION	6
4.1. Terminal assignment	6
4.2. Connection data	6
4.3. Connection example	7
4.3.1. Connection information:	7
5. COMMISSIONING AND CONFIGURATION OF THE EB3000	8
5.1. Initial commissioning of the EB3000	8
6. OPERATION OF THE EB3000	8
6.1. How to display the current measurement values.....	8
6.2. How to display or reset the min-/max-values	9
6.3. Setting of switching points.....	9
6.4. Setting of alarm limits.....	9
7. ERROR CODES	11
8. SPECIFICATION	14
9. DISPOSAL NOTES	14
10. EB3000 - CONFIGURATION	15
10.1. EASYBUS - Configurator	15
10.1.1. Interface configuration.....	15
10.1.2. Perform EASYBUS system initialisation	15
10.1.3. Read EASYBUS	15
10.2. EB3000 - Configuration.....	16
10.2.1. Tab: monitoring / display.....	16
10.2.2. Tab: control outputs	18
10.2.3. Tab: alarm.....	18
10.2.4. Tab: virtual channels.....	19
10.2.5. Tab: others	19

1. Safety regulations

This device was designed and tested considering the Safety regulations for electronic measuring devices. Faultless operation and reliability in operation of the measuring device can only be assured if the General Safety Measures and the devices specific safety regulation mentioned in this users manual are considered.

1. Faultless operation and reliability in operation of the measuring device can only be assured if the device is used within the climatic conditions specified in the chapter "Specifications".
2. Always disconnect the device from its supply before opening it. Take care that nobody can touch any of the unit's contacts after installing the device.
3. Standard regulations for operation and safety for electrical, light and heavy current equipment have to be observed, with particular attention paid to the national safety regulations (e.g. VDE 0100).
4. When connecting the device to other devices (e.g. the PC) the interconnection has to be designed most thoroughly, as internal connections in third-party devices (e.g. connection of ground with protective earth) may lead to undesired voltage potentials.
5. The device must be switched off and must be marked against using again, in case of obvious malfunctions of the device which are e.g.:
 - visible damage
 - no prescribed working of the device
 - storing the device under inappropriate conditions for longer time

When not sure, the device should be sent to the manufacturer for repairing or servicing.



Attention: When running electric devices, parts of them will always be electrically live. Unless the warnings are observed serious personal injuries or damage to property may result. Skilled personnel only should be allowed to work with this device. For trouble-free and safe operation of the device please ensure professional transport, storage, installation and connection as well as proper operation and maintenance.

Skilled personnel

are persons familiar with installation, connection, commissioning and operation of the product and have professional qualification relating to their job.

For example:

- Training or instruction resp. qualifications to switch on or off, isolate, ground and mark electric circuits and devices or systems.
- Training or instruction according to the state.
- First-aid training.

ATTENTION:

Do NOT use this product as safety or emergency stopping device, or in any other application where failure of the product could result in personal injury or material damage.

Failure to comply with these instructions could result in death or serious injury and material damage.

2. Introduction

The EB3000 is an universal control, display and supervisory device for **EASYbus**-sensor modules.

The EB3000 is equipped with 20 internal channels (channel-nr. 1..20), which can be allocated arbitrary to different **EASYbus**-measurement channels and 2 virtual channels (channel-nr. 21 and 22), to download arbitrary calculation functions.

Furthermore the EB3000 has 4 switching outputs and an alarm output.

The 22 channels can be allocated arbitrary to the 4 switching outputs to realise different type of control (2-point-, 3-point-controller, stepping switch etc.).

Due to load arbitrary calculation functions it is possible to realise extensive display and control functions (as

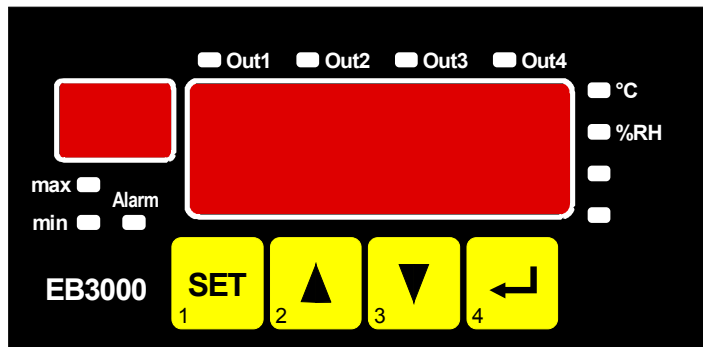

averaging, Difference regulation etc. .

The device features 2 displays: a 4-digit 13mm high 7-segment display (main display) to indicate measurement values or error codes and a 2-digit 7mm high 7-segment display (auxiliary display) for indication of the free configurable channel description.

Additionally there are 4 LED's for displaying the unit of the current measurement channel, 4 LED's for displaying the actual state of the switching outputs and 3 LED's which illuminates in case of alarm or in case of a selected min-/max-value.

The device has 2 **EASYbus**-Interfaces:

- **EASYbus**-output: connection for the **EASYbus**-sensor modules
- **EASYbus**-input: permits via level converter (e.g. EBW1, EBW64, ...) communication with a superior computer (master).

The EB3000 cyclically enquires all the allocated measurement channels. The sequence for processing the channels isn't firm, because there is a dynamic request fitted to each channels slightest updating-rate (time-out). Measurement channels with fast turn of events are frequently requested as measurement channels with slow turn of events.

The EB3000 checks the compliance of the required updating-rate. If the enquiry of a measurement channel, within a specified time-interval, as a result of bus capacity overload (e.g. by frequent and time-consuming enquiries of the master), is not possible, a 'timeout'-errormessage indicates on the display and alarm is activated. If not required, timeout-control can also be deactivated.

Before the EB3000 can be used, it has to be configured for the customer's application (see chapter 5).

2.1. **EASYbus**-terms and definitions

Declaration of used terms and definitions:

EASYbus-sensor modules sensor module for connection on **EASYbus**
(e.g. **EASYLOG 40K**, **EASYLOG 24RFT**, **EASYLOG 40NS**, **EBHT**)

EASYbus-measurement channel measurement channel of an **EASYbus**-sensor module
The **EASYbus**-modules can feature one ore more measurement channels
(e.g. **EASYLOG 24RFT** and **EBHT** features 2 channels – one channel for humidity and one channel for temperature measurement)

3. Display elements and pushbuttons

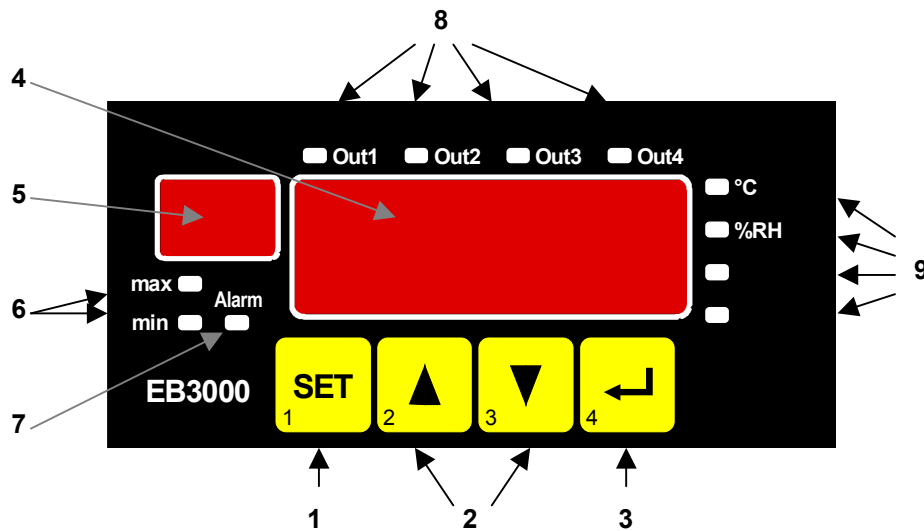

Device front view

- | | |
|-----------------------------|--|
| 1 Key 1: | change-over to setting mode (in combination with key 2 or 3)
switching between indication of current value, min-value and max-value |
| 2 Key 2: | change-over to next measurement channel |
| Key 3: | change-over to further measurement channel
increasing / decreasing of the last setting
setting mode selection |
| 3 Key 4: | interruption / recognition of the last setting
acknowledgement of an error message |
| 4 Main display: | indication of current measurement value resp. min./max-value |
| 5 Auxiliary display: | indication of current measurement channel |
| 6 Min-/max-values: | illuminates in case of a selected min-/max-value |
| 7 Alarm display: | illuminates in case of an alarm |
| 8 LED's Out1...4: | indicates the actual state of the switching outputs |
| 9 LED's 1...4: | displays the unit of the current measurement channel |

4. Electric connection

Electric connection and commissioning of the device must be carried out by trained and skilled personnel.

Wrong connection may lead to the destruction of the device, in which case we cannot assume any warranty.

Make it a rule to always mount screw-type/plug-in terminals while they are still loose and connect only later. If terminals are mounted after connection there is a risk that soldering eyes may come loose. Please use suitable screw-driver and do not tighten screws by force.

4.1. Terminal assignment

14	Switching output 1..4 (common connector)
13	Switching output 1 (normally open)
12	Switching output 2 (normally open)
11	Switching output 3 (normally open)
10	Switching output 4 (normally open)
9	Alarm output (normally closed)
8	Alarm output (normally open)
7	Alarm output (common connector)
6	Supply voltage: 230V _{AC}
5	Supply voltage: 230V _{AC}
4	EASYbus-Input (to PC/Host)
3	EASYbus-Input (to PC/Host)
2	EASYbus-Output (to EASYBUS -sensor modules)
1	EASYbus-Output (to EASYBUS -sensor modules)

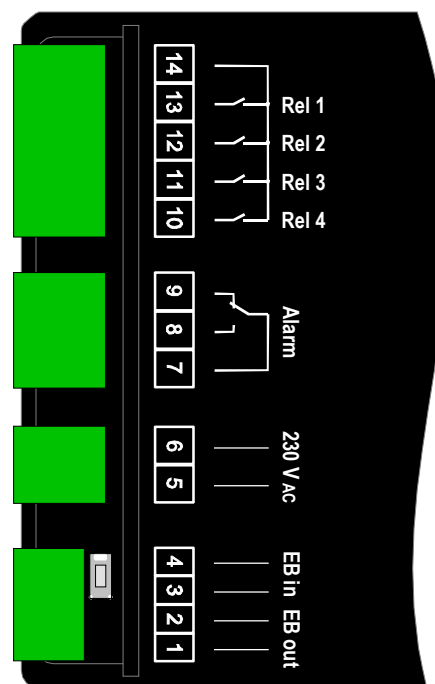

4.2. Connection data

	between terminal	typical		limitations		notes
		min.	max.	min.	max.	
Supply voltage	5 and 6	207 V _{AC}	243 V _{AC}		250 V _{AC}	or as specified on rating plate
Switching outputs	14 and 13, 14 and 12, 14 and 11, 14 and 10				250 V _{AC} 5A (ohmic load)	Use RC circuit elements or varistors for inductive loads
Alarm output	7 and 8, 9				250 V _{AC} 5A (ohmic load)	Use RC circuit elements or varistors for inductive loads
EASYbus-output	1 and 2		36 V _{DC}			
EASYbus-input	3 and 4		36 V _{DC}			

These limits must not be exceeded (not even for a short time) !

4.3. Connection example

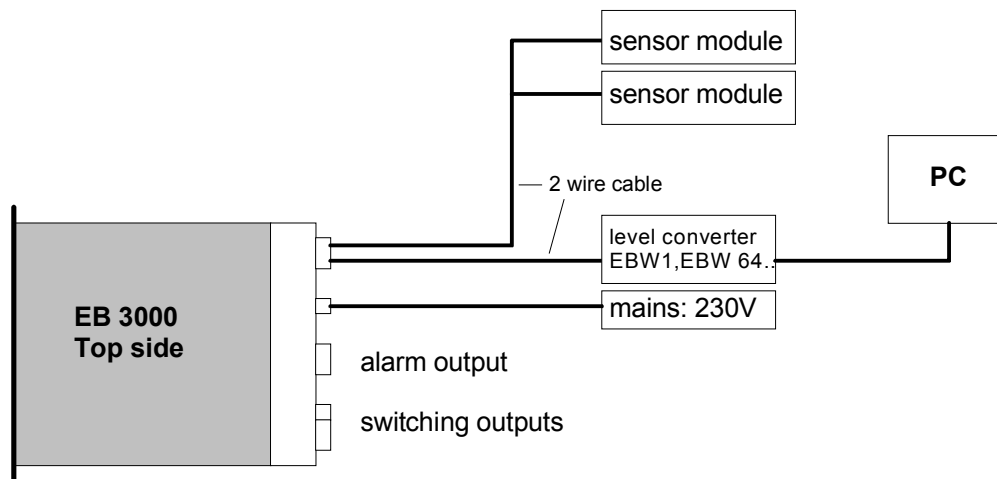

Example for connection

Hint: *In order to avoid undefined input states and unwanted or wrong switching processes, we suggest to connect the device's switching outputs after You have configured the device properly.*

4.3.1. Connection information:

The interface-converter can supply the specified numbers of **EASYbus** standard loads (max. 30 pieces). The module management is limited to max. 20 **EASYbus**-measuring channels.



Please note that some EASYbus -modules have a higher bus load as the standard load! Please notice the corresponding specification in the module manual.

Bus loads of some **EASYbus** modules:

EASYlog -family:	2 EASYbus standard loads
EBN:	2 EASYbus standard loads
EBHT, EBT, EBH:	1.5 EASYbus standard loads
GIA20EB, GIR2002:	1 EASYbus standard load

When connecting the modules keep in mind that the sum of all bus loads of the modules must not exceed the maximal allowed number.

Worked sample:

1) Connection of 5 **EASYlog**, 8 EBHT and 7 GIA20EB:

$$5 * 2 + 8 * 1.5 + 7 * 1 = 10 + 12 + 7 = 29 \text{ standard loads (20 devices)} \Rightarrow \text{connection is possible}$$

2) Connection of 15 **EASYlog** and 2 EBN:

$$15 * 2 + 2 * 2 = 30 + 4 = 34 \text{ standard loads (17 devices)} \Rightarrow \text{EB3000 are overloaded!}$$

3) Connection of 4 EBHT and 20 GIA20EB:

$$4 * 1.5 + 20 * 1 = 6 + 20 = 26 \text{ standard loads (24 devices / 28 meas. channels)} \Rightarrow \text{max. number of meas. channels transcended!}$$

*Please note: The **EASYbus**-modules can feature more as one measurement channels (e.g: EBHT, ...)*

5. Commissioning and configuration of the EB3000

For configuration and commissioning of the EB3000 the software **EASYBus-configurator** is necessary. You will find this software for free on one of our different product-CD's or on homepage www.greisinger.de under area SERVICE beneath FREEWARE.

5.1. Initial commissioning of the EB3000

Before commissioning the EB3000, a proper and complete installation and wiring of the entire EASYBus-system is required.

Please start software **EASYBus-Configurator** and carry out a system initialisation. For further details read the operating manual of the **EASYBus-Configurator**.

By double-click on EB3000-symbol the EB3000-configuration window appears.

Choose register-tab monitoring / display and make following settings for each channel:

- allocation of a measurement channel
- setting of the required timeout
- setting of display endurance, text for auxiliary display and appearance of the unit-LED's

Choose register-tab control outputs and make following settings for each output:

- allocation of a channel number
- setting of switching-on-point, switching-off-point, switching-delay and function

To use EB3000 calculation functions, choose register-tab virtual channels for programming the desired function for virtual channel 1 or 2.

For details see chapter 9. EB3000-Configuration

6. Operation of the EB3000

*Hint: Keys 2 and 3 are equipped with a 'roll-function' for an easy input of values. By pushing this key shortly the display increases (key 2) resp. decreases (key 3) at any one time about 1 digit.
By pushing the keys longer than 1 second the value starts to count up resp. to count down, whereas the counting speed increases after a short time.*

6.1. How to display the current measurement values

In the standard mode the current measurement values (actual values) of the measurement channels will be displayed in the main display.

In the auxiliary display the text appears, which was configured for the respective channel.

There are two modes of display:

Static display:

The selected channel will be displayed constantly; use keys 2 (up) and 3 (down) for channel selection.

Cyclic display:

All channels will be indicated one after another by the adjusted display endurance. By configuration display endurance can be set for each channel separately (see chapter 5). If cyclic display is activated, the decimal point right next to the auxiliary display illuminates.

Key-operating:

- key 2 and 3 shortly pushed: cyclic display switches on/off
- key 2 shortly pushed: displaying of next channel
- key 3 shortly pushed: displaying of previous channel

6.2. How to display or reset the min-/max-values

You can call and display the min-/max-values of the **EASYbus**-measurement channels by using EB3000.

Hint: *The EB3000 can only readout the respective min-/max-values. The values stored in the respective sensor modules will not be saved in the EB3000.*

If a min-/max-value is shown, LED „min“ resp. „max“ illuminates.

Key-operating:

- Key **1** shortly pushed: display changes between actual value, min-value and max-value
- Key **1** pushed >1 sec.:

if cyclic display = off:	clear min-/max-values of the displayed measurement channel.
if cyclic display = on:	clear min-/max-values of all activated measurement channels.

After 30 sec. the display of the min-/max-values automatically finish and the actual value is shown again.

6.3. Setting of switching points

The switching-on-points and switching-off-points of the outputs can be called and changed via the input keys. Therefore only switching outputs with an allocated channel are shown. **If no channel was allocated to the switching output a call of function ‚setting of switching points‘ is not possible.**

Please note: *If no key is pushed by inputting a value longer than 10 sec., it will be changed to the parametric display again, after another 30 sec. the switching point setting of the device will be stopped. Not stored modifications will not be saved and are lost!*

Hint: *A call is only possible, if the display of the device shows the actual value*

- Push key **1** and **2** for >1 second

In the main display „**X.on**“ resp. „**X.off**“ appears.

(X = number of the switching output, on = switching-on-point, off = switching-off-point).

In the auxiliary display the text of the allocated channel appears.

- Use key **1** to select the adjustable switching parameter.
- Push key **2** or **3**.
In the main display the currently adjusted switching point appears.
- Use key **2** and **3** to set the new desired value, whereas this output shall be switched on or off.
- Use key **1** to acknowledge the adjusted switching point. The new switching point will be saved and in the main display „**X.on**“ resp. „**X.off**“ appears again.

*With key **4** you can cancel the setting at any time, the made modification is resetted and in the main display „**X.on**“ resp. „**X.off**“ appears again.*

- Use key **1** to select the next adjustable switching parameter and set as described.

With key **4** you can cancel/finish the setting of the switching point at any time, and the actual measurement value is displayed again.

Hint: *The setting of the switching points can also be performed comfortable for each channel with software „EASYBUS-Configurator“ (see chapter 8 – appendix).*

6.4. Setting of alarm limits

If the connected **EASYbus**-measurement channel supports an alarm function the min-/max alarm limits and the alarm delay can be called and changed via the input keys.

Please note: *If no key is pushed by inputting a value longer than 10 sec., it will be changed to the parametric display again, after another 30 sec. the switching point setting of the device will be stopped. Not stored modifications will not be saved and are lost!*

Hint: *Here you can call and change the alarm limits of the **EASYbus**-measurement channel. The alarm limits stored in the **EASYbus**-sensor modules will not be saved in the EB3000.*

The settings of the alarm limits will only be carried out for the currently displayed measurement channel.

TIPP: *For setting the alarm limits we suggested to switch-off the cyclic display for a „manually“ selection of the setting channel.*

Hint: A call is only possible, if the display of the device shows the actual value

- Push key 1 and 3 for >1 second.
In the display "**AL.Hi**" appears (alarm high, max-alarm limit).
- Push key 2 or 3.
In the main display the currently adjusted max-alarm limit appears.
- Use key 2 and 3 for setting the desired new value, when max-alarm shall be released.
*With key 4 you can cancel the setting at any time, the made modification is resetted and in the main display "**AL.Hi**" appears again.*

- Confirm the adjusted value with key 1, in the main display "**AL.Hi**" appears again.
- Press key 1 again, and the adjusted alarm value will be saved into the sensor module, in the display "**AL.Lo**" appears (alarm low, min-alarm limit).

*If an error occurs when saving the value into the sensor module, this error will be indicated on the main display. The error must be acknowledged by pushing key 1. The display shows furthermore parameter "**AL.Hi**".*

With key 4 you can cancel the settings at any time, the made modifications are resetted and the actual measurement value is displayed.

- Push key 2 or 3.
In the main display the currently adjusted min-alarm limit appears.
- Use key 2 and 3 for setting the desired new value, when min-alarm shall be released.
- Confirm the adjusted value with key 1, in the main display "**AL.Lo**" appears again.

*With key 4 you can cancel the setting at any time, the made modification is resetted and in the main display "**AL.Lo**" appears again.*

- Press key 1 again, and the adjusted alarm value will be saved into the sensor module, in the display "**A.dEL**" appears (alarm delay).

*If an error occurs when saving the value into the sensor module, this error will be indicated on the main display. The error must be acknowledged by pushing key 1. The display shows furthermore parameter "**AL.Lo**".*

With key 4 you can cancel the settings at any time, the made modifications are resetted and the actual measurement value is displayed.

- Push key 2 or 3.
In the main display the currently adjusted alarm delay in minutes appears.
- Use key 2 and 3 for setting the desired new alarm delay.
- Confirm the adjusted value with key 1, in the main display "**A.dEL**" appears again.

*With key 4 you can cancel the setting at any time, the made modification is resetted and in the main display "**A.dEL**" appears again.*

- Press key 1 again, and the adjusted alarm delay will be saved into the sensor module, in the display "**AL.Hi**" appears again (alarm high, max-alarm limit).

*If an error occurs when saving the value into the sensor module, this error will be indicated on the main display. The error must be acknowledged by pushing key 1. The display shows furthermore parameter "**A.dEL**".*

With key 4 you can cancel the settings at any time, the made modifications are resetted and the actual measurement value is displayed.

- Press key 4 to complete the settings.

7. Error codes

When detecting an operating state which is not permissible, or the current **EASYbus**-measurement channel has an undefined operating state, the EB3000 will display an appropriate error code.

The following error codes are defined. An error code will displayed, if an **EASYbus**-measurement channel with an occurred error is selected.

Err.1: Exceeding of the measurement range

Indicates that the valid measuring range of the **EASYbus**-measurement channel has been exceeded.

*For possible causes and remedies please read the operation manual of the **EASYbus**-sensor module*

Err.2: Values below the measuring range

Indicates that the values are below the valid measuring range of the **EASYbus**-measurement channel.

*For possible causes and remedies please read the operation manual of the **EASYbus**-sensor module*

Err.3: Display range has been exceeded

Indicates that the valid display range (9999 digit) of the device has been exceeded.

Possible causes:

- Incorrect scale.
- Counter overflow.

Remedies:

- The error-message will be reset if the display value is below 9999.
- Reset the counter.

When happening frequently, check the scale-setting, maybe it was set too high and should be reduced (e.g. factor 10)

Err.4: Values below display range

Indicates that display value is below the valid display range of the device (-1999 digit).

Possible causes:

- Incorrect scale.
- Counter underflow.

Remedies:

- The error-message will be reset if the display value is above -1999.
- Reset the counter

When happening frequently, check the scale-setting, maybe it was set too low and should be increased (e.g. factor 10)

Err.7: System-error

The device features an integrated self-diagnostic-function which checks essential parts of the device permanently. When detecting a failure, error-message Err.7 will be displayed.

*For possible causes and remedies please read the operation manual of the **EASYbus**-sensor module*

Err.9: Sensor defective

The device features an integrated diagnostic-function for the connected sensor resp. transmitter. When detecting a failure, error-message Err.9 will be displayed.

*For possible causes and remedies please read the operation manual of the **EASYbus**-sensor module*

Er.11: Value could not be calculated

Indicates a measuring value, needed for calculation of the display value, is faulty resp. out of range.

*For possible causes and remedies please read the operation manual of the **EASYbus**-sensor module*

Er.12: Received datasets invalid

Indicates, that the received **EASYbus**-sensor module datasets for this **EASYbus**-measurement channel is invalid.

Possible causes: - **EASYbus**-measurement channel with an error indication

Remedies: - check **EASYbus**-sensor module

E.-23: Transmission error: EASYBus-modul not responding

Indicates, that the attached **EASYbus**-sensor module does not responding an enquiry.

Possible causes: - **EASYbus**-sensor module not connected or defective
- incorrect system initialisation or configuration
- uncouple / access of the sensor module via PC-software (e.g. searching of GSOFT40K)

Remedies: - check **EASYbus**-sensor module and connection
- perform new configuration of the EB3000
- check bus access via PC-software

E.-25: Transmission error: CRC-Code wrong

Indicates, that the enquiry of an attached **EASYbus**-measurement channel has generated an CRC-error.

Possible causes: - multiple attached **EASYbus**-measurement channels have the same address
- **EASYbus**-sensor module defective

Remedies: - perform new **EASYbus**-system initialisation

E.-38: No acknowledge received (unknown operation call)

Indicates, that the selected function of the attached **EASYbus**-measurement channel (at present) is not supported.

Possible causes: - a working Logger accepts some settings only in stop-modus
- module = GIA20EB: alarm function not activated

Remedies: - stop Logger
- activate alarm function of the GIA20EB beneath "out"

E.-41: Data received within locked range

Indicates, that received data are not in a valid **EASYbus**-value range.

Possible causes: - **EASYbus**-sensor module incorrect configured or defective

Remedies: - check **EASYbus**-sensor module

E.-44: Transmitted data modified removed

Indicates, that transmitted data varied from data, saved and acknowledged from **EASYbus**-sensor module.

Possible causes: - The transmitted data are outside of a permissible value range of the **EASYbus**-measurement channel.
- The **EASYbus**-sensor module has accepted a possible min / max value and has send back this value to the EB3000.

Remedies: ---

----: no measurement channel allocated

Indicates, that the displayed channel is configured with no allocated **EASYbus**-measurement channel.

Possible causes: - incorrect configuration

Remedies: - perform new configuration of the EB3000

t.out: Timeout occurrence

This error message alternates with the current display value and indicates, that's not possible to enquire the **EASYbus**-measurement channel within the minimum required updating-rate.

Possible causes: - a system initialisation was performed
- incorrect configuration
- bus is blocked in fact of a master requiry

Remedies: - remove alarm by pushing key 4 or by using EASYBUS-Configurator software
- perform new configuration of the EB3000

The following system-error-codes are defined:

. : no measurement channel for indication selected

(only a point is indicated down right of the display)

Indicates, that all channels are configured with display endurance 0.

Er.49: Capacity overload of the EASYbus-output

This error message alternates with the current display value and indicates, that the max. allowable value of the **EASYbus**-output has been exceeded.

Possible causes: - too many **EASYbus**-sensor modules connected on EB3000
- connection line with shortcut

Remedies: - check connection of the **EASYbus**-sensor modules

8. Specification

Display range:	-1999 ... +9999 Digit
Resolution:	Automatically recognition of the resolution of the connected EASYbus -measurement channel. Decimal point is set automatically.
Accuracy:	Depending on the respective EASYbus -measurement channel. The EB3000 is receiving this value digital without additional error.
Sensors:	All EASYbus -sensor modules (inclusive EASYlog , GIA20EB, GIR2002, ...) are connectable. The connection effected not polarised via 2-wire connection cable in ring-, tree-, or star- configuration.
- sensor supply:	Effected through EB3000
- max. bus load:	max. 30 EASYbus standard loads
- max. meas. channels:	20
- permissible cabel length:	200 m (depending on cabeltyp and wiring)
Switching outputs:	4 relay outputs (normally open), switching to one common connector. Each output can arbitrary allocate to each measurement channel.
- Switching capacity:	230VAC, 5A, ohmic load
- Output functions:	2-point controller, 2-point controller inverse, switching point, switching delay for each output individually adjustable.
Alarm output:	1 relay output (changeover)
- Switching capacity:	230VAC, 5A, ohmic load
- Alarm functions:	Collective alarm for all sensors, alarm settings for all sensors changeable
Displays:	Main display: 4-digit red 13mm high 7-segment LED-display Auxiliary display: 2-digit red 7mm high 7-segment LED-display 11 additional LED's for unit-, switching function- and alarm display
Operating:	via 4 pushbuttons
Host-Interface:	EASYbus -Interface, electrically isolated
Nominal temperature:	25°C
Operating temperature:	-25 ... +50°C
Relative humidity:	0 ... 80% r.H. (non-condensing)
Storage temperature:	30 ... +70°C
Power supply:	230V AC 50/60Hz, or as specified on rating plate
Nominal operating power:	ca. 9 VA
Housing:	Standard rack housing 48 x 96 x 100mm (H x B x T)
Panel cut-out:	43 x 90,5 mm (H x B)
Electric connection:	Screw-type/plug-in terminal; cross-section 0.14 ... 1.5 mm ²
Protection class:	Front IP54, with optional sealing insert IP65
EMC:	EN61326 +A1 +A2 (appendix A, class B), additional errors: < 1% FS When connecting long leads adequate measures against voltage surges have to be taken.

9. Disposal notes

This device must not be disposed as 'residual waste'.

To dispose this device, please send it directly to us (adequately stamped). We will dispose it appropriately and environmentally friendly.

10. EB3000 - Configuration

10.1. EASYBUS - Configurator

Please start software **EASYBus-Configurator**. The **EASYBus-Configurator** opening-window appears. Before starting of **EASYBus**-Configuration some pre-adjustments must be arranged.

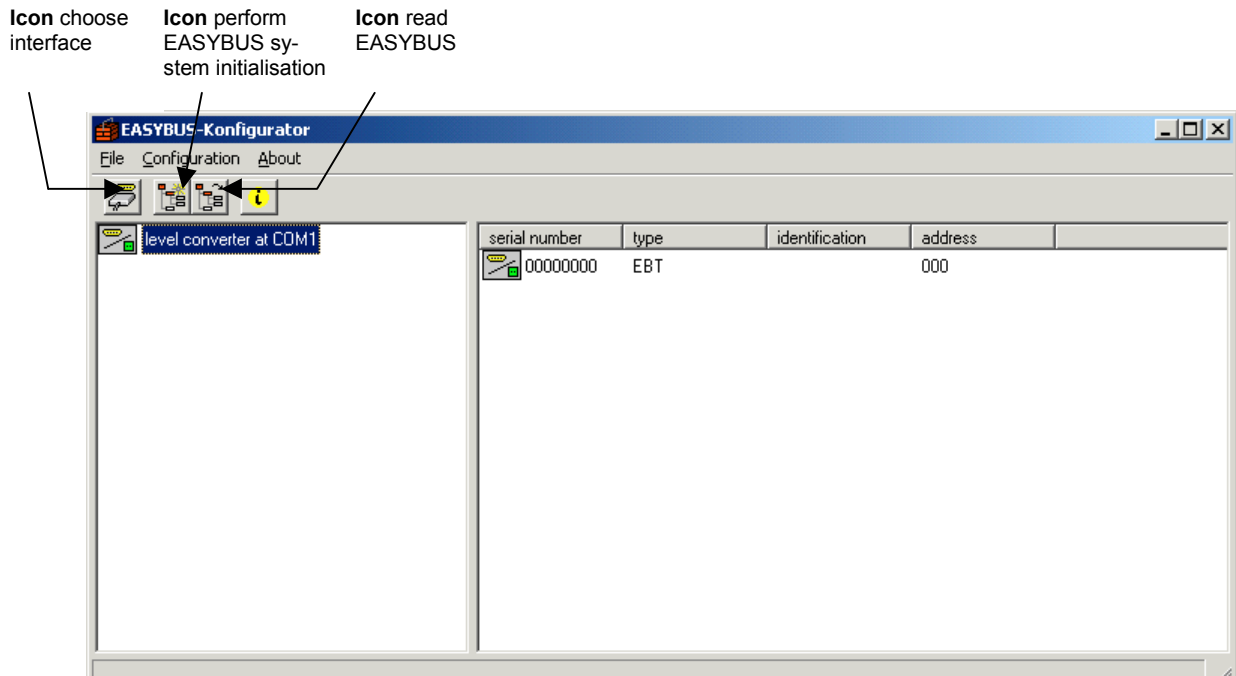

10.1.1. Interface configuration

With Icon „choose interface“ we reached setting-window interface configuration. Please choose the appropriate port.

10.1.2. Perform EASYBUS system initialisation

Before first commissioning the **EASYBus**-system a system initialisation is **mandatory**.

Please choose Icon „perform EASYBUS system initialisation“, notice the following warning and acknowledge this special note by pushing the OK-key.

Hint: *Perform system initialisation only by first commissioning, otherwise you have the risk of a changed system configuration. In this case the following described EB3000-configuration must be performed again.*

Afterwards you reached the EB3000-configuration window (displayed on next page) with all available **EASYBus**-components and serial numbers.

Go to **point 9.1.3.** if a system initialisation is not necessary

10.1.3. Read EASYBUS

If system initialisation is not required, you must read-in the **EASYBus**-system informations.

Please choose Icon „read EASYBUS“ and acknowledge the following notification by pushing the OK-key.

Hint: *Please note, when reading the EASYBus-system informations an ascending sequence of the address numbers (commencing with 1) is necessary. If you remove an EASYBus-sensor module out of the system (or if a sensor module is defective), so maybe not all connected sensor modules can be detected.*

Now you likewise reached the following displayed EB3000-configuration window with all available **EASYBus**-components and serial numbers.

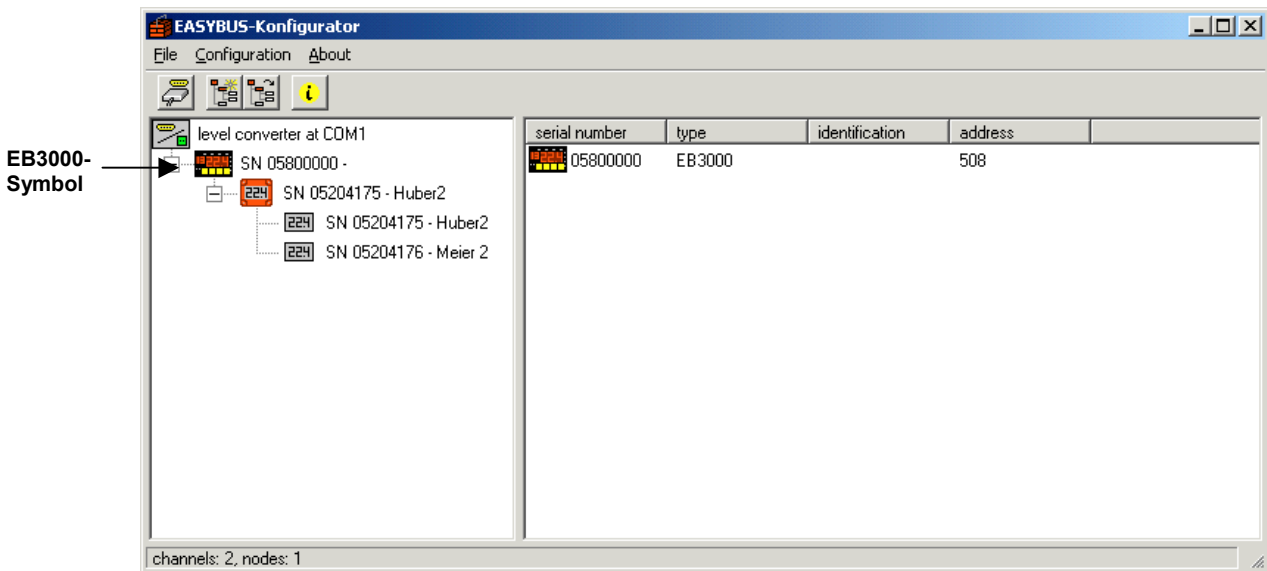

10.2. EB3000 - Configuration

By double-click on the EB3000-symbol on the device-overview a configuration window for the EB3000 opens.



Now 5 register-tabs are available:

- monitoring / display
- control outputs
- alarm
- virtual channels
- others

10.2.1. Tab: monitoring / display

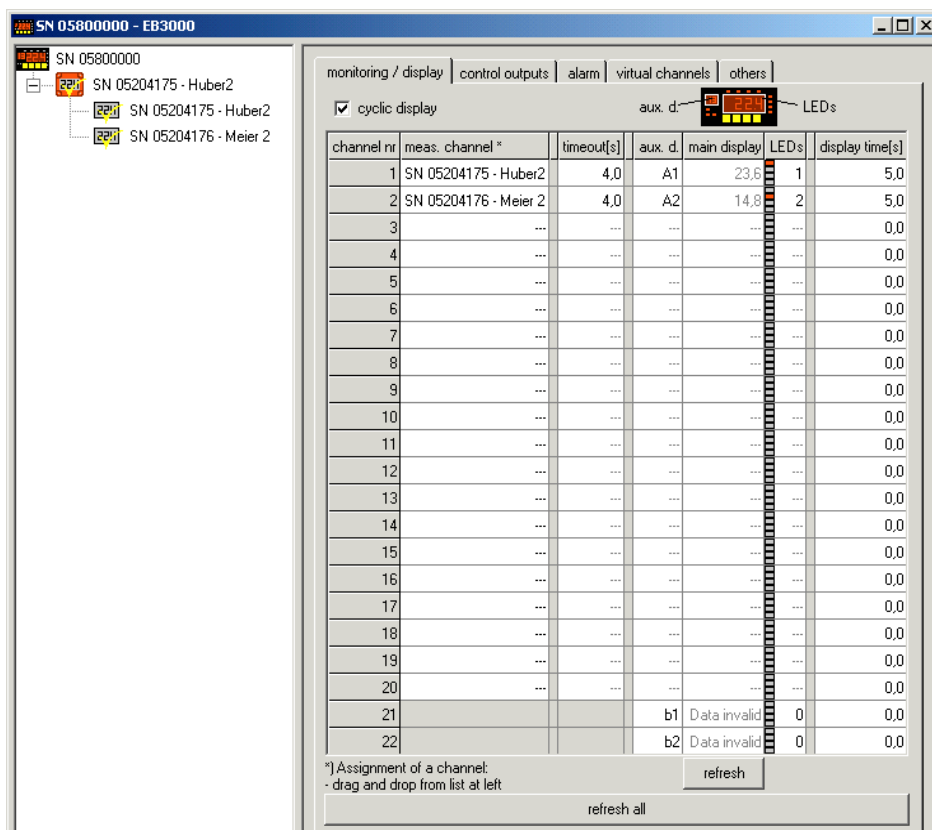

Here are 2 essential settings:

1) Allocation of the respective measurement channels

- By **measurement channel** the **EASYbus**-measurement channel with identification number is shown, which is allocated to the respective channel. Until 20 channels can be listed. Measurement channels can also be multiple listed and you can change the order of sequence as you like, so that by cyclic display (adjustable in the control box on the top left-hand corner) any cyclic illustration flow is reachable.

Reselection resp. modification of the left shown attached **EASYbus**-measurement channels results via „drag and drop“ or by activation of the right mouse button.

Hint: „---“ means that no measurement channel is allocated and this channel will not be monitored.

- By **timeout** the minimum updating-rate of the measurement channels in seconds will be specified (adjustable between 8,0 and 50,0 seconds). If a updating of the measurement value of the respective measurement channel within the specified time-interval will not be possible (resp. overload of bus capacity), an error message will be displayed (timeout-error).

Hint: For fully occupied measurement system choose timeout duration not too low, to avoid error messages of the measurement system.

2) Predetermination of the display of individual channels

- **auxiliary display** „channel description“ for the respective channel shown in the auxiliary display. The input of the „channel description“ can be 2-digit, both letters and numbers are accepted. Hand-over of the channel description causes via click outside of the input folder resp. by pushing the enter-key. If the decimal point next to the channel description of the auxiliary display illuminates, cyclic operation is adjusted.

Hint: please note, because of the restricted possibility of the 7-segment-display not all letters can be indicated.

- **main display** measurement value of the respective channel.
For actualisation push button „refresh“ beyond this column.

- **LED's** you can allocate one or more „unit-LED's“ to each measurement channel. The 4 „unit-LED's“ are on the front side of the EB3000 on the right side next to the main display. This settings are binary coded (for example by setting value 3 illuminates LED 1+ LED 2). A click with the right mouse button on the respective value opens dialogue window „edit unit-LED's“.

- **display endurance** duration time in seconds, how long this channel will be indicated by cyclic display (max.25,5s).

Hint: there is no relationship between display endurance and channel monitoring. For example by setting display endurance = 0 the respective channel will not be displayed but he will be monitored.

10.2.2. Tab: control outputs

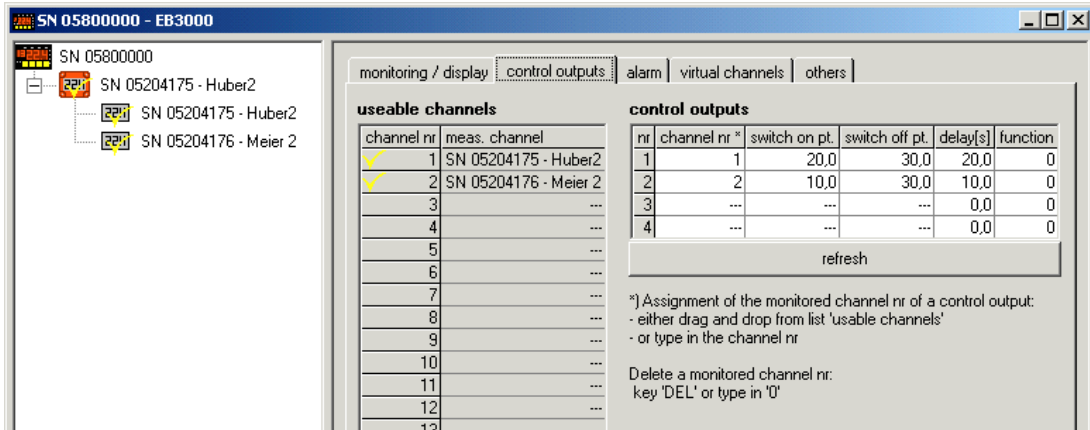

- **channel-nr.** allocated measurement channel for this output.
(The regulation function is assigned to this measuring value)
- **switch.-on-point, switch.-off-point:** switching points of the outputs (can also be modified via EB3000-device keys)
- **delay** minimum switching delay in seconds after a turn-off until output turns on again
- **function** switching function of the outputs (in case of error, see chapter 6 – error codes).

The following switching functions are defined:

0 – preference in case of error: switching output off

1 – preference in case of error: switching output on

10.2.3. Tab: alarm

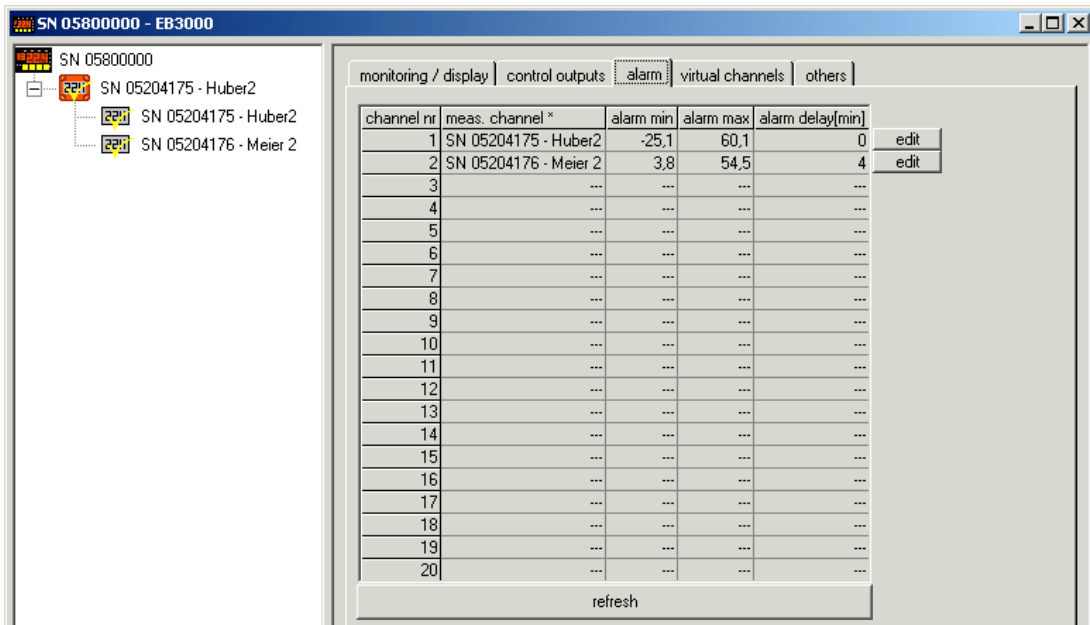

Adjustable are following values:

- minimum alarm limit (alarm min)
- maximum alarm limit (alarm max)
- alarm delay (declaration in minutes)

10.2.4. Tab: virtual channels

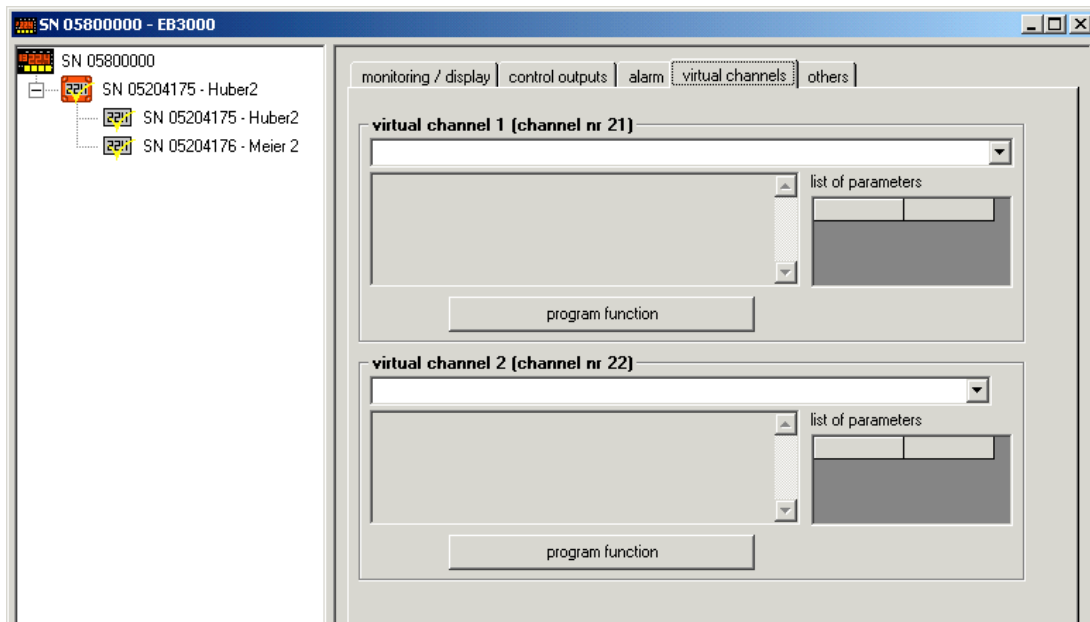

Here you can select functions for both „virtual channels“ for programming into the EB3000.

If the desired function is not available, please visit our homepage. Here additional functions for download are available.

After download copy transferred datafiles easily into directory „EB3CV“ inside of the configurator-installation directory. By the next start of register-tab „virtual channels“ the function will be available for selection.

10.2.5. Tab: others

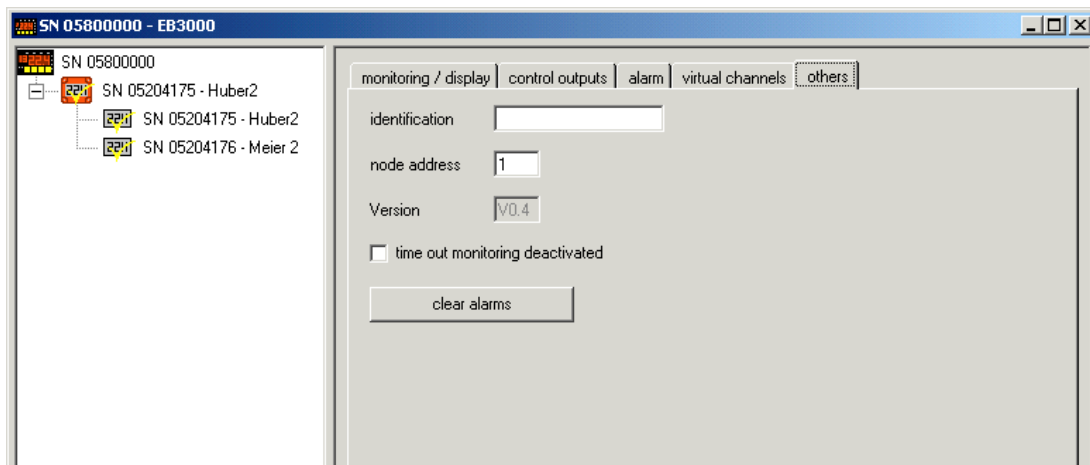

Here you have the ability to determine a device identifier and a node address. Furthermore you can deactivate timeout monitoring and clear alarms. Additionally you can see the version number of the EB3000.