



Operating Instructions

THI · THIP · TCO LAN data loggers

BA-THI-THIP-TCO-01-EN

Table of Contents

| Contents | Page |
|---|----------|
| 1. Safety Instructions | 2 |
| 2. Intended Purpose and Use | 2 |
| 3. Features | 3 |
| 4. Scope of Delivery | 3 |
| 5. Preparations Prior to Use | 4 |
| 5.1. Software | 4 |
| 5.1.1. Installation Requirements | 4 |
| 5.1.2. Installing the SmartGraph Software | 4 |
| 5.1.3. Preparing the Data Logger Configuration | 4 |
| 6. Operating the Data Logger | 4 |
| 6.1. Powering ON/OFF | 4 |
| 6.2. Basic Settings and Operating Modes | 4 |
| 6.2.1. The Four Operating Modes | 4 |
| 6.2.2. Network Function (M51) | 5 |
| 6.2.3. Factory Settings (M52) | 5 |
| 6.2.4. Acoustic Function (M53) | 5 |
| 7. Measuring Value Display and Data Logging | 6 |
| 7.1. Sensors, Channel Groups and Measuring Channels | 6 |
| 7.2. Displaying Measuring Values | 6 |
| 7.3. Data Logging | 6 |
| 8. Alarm Function | 7 |
| 8.1. Alarm Configuration | 7 |
| 8.2. Alarm Symbol on the Display | 7 |
| 8.3. Acoustic Alarm | 7 |
| 8.4. Using the Alarm Hysteresis | 7 |
| 9. Cleaning and Maintenance Instructions | 8 |
| 9.1. Replacing the Batteries | 8 |
| 9.2. Installation During Mobile Operation | 8 |
| 9.3. Mounting the Logger on a Wall | 8 |
| 9.4. Changing Locations | 8 |
| 10. Technical Data | 9 |

This publication replaces all previous publications. No part of this publication may be reproduced, processed using electronic systems, replicated or distributed in any way without prior written authorisation by us. Subject to technical modifications. All rights reserved. Names of goods are used without guarantee of free usage and used for the most part according to the manufacturers' syntax. The names of goods used are registered and should be considered as such. We reserve the right to modify the design in the interest of ongoing product improvement, such as shape and colour modifications. The scope of delivery may vary from that in the product description. All due care has been taken in compiling this document. We accept no liability for any errors or omissions.

Please read this manual carefully. These instructions are designed to ensure that your data logger is used for the purpose for which it was intended and to guarantee that you get the maximum benefit from your product.

These **operating instructions** describe the functions of the hardware.

There is also a separate **software manual** available. This manual shows you how to configure your data logger and how to use the software. The manual can be accessed using the Help function as soon as it has been installed.

Your new data logger was designed and manufactured in line with the latest technological advancements and complies with the requirements as laid down in existing European and national guidelines. Conformity has been certified. The relevant declarations and documents are in the possession of the manufacturer.

As the user you must read and adhere to the following safety instructions in order to ensure that this condition is maintained and that no danger results from the use of this device:

1. Safety Instructions

We do not accept any liability for any damages which might occur as a result of improper use or the non-observance of these instructions. The guarantee expires with immediate effect in any such case!



These instructions must be read in full before this measuring device is put into operation for the first time!

For reasons of safety and CE compliance you may on no account carry out any changes or modifications on either the device itself or any other components which may be used in connection with this measuring device!

The following instructions must be adhered to before the device is taken into use:

- Do NOT carry out measurements on live components.
- Please observe the sensor measuring range.
- Please observe the operating and storage conditions.
- The user is solely responsible for determining whether he or she considers the measuring results to be valid and for any conclusions that are reached or any measures that are taken as a result thereof. We can neither guarantee the validity of any measuring results nor can we accept liability for any such results. We are on no account able to accept liability for any damage which may be caused as a consequence of the use of these measuring results.

2. Intended Purpose and Use

The data logger is designed to determine and log a variety of different measuring values which can be measured using the sensors as described in the technical specifications. The measuring data can either be logged, called up or saved to a connected PC in randomly selectable intervals.

This measuring device may only be used within the specified technical specifications for the purpose for which it was intended.

Any other use is considered to be improper and constitutes a violation of these conditions.

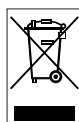

This product should not be disposed of in your general waste. Please ensure that it is disposed of in an orderly manner in accordance with existing regulations.

3. Features

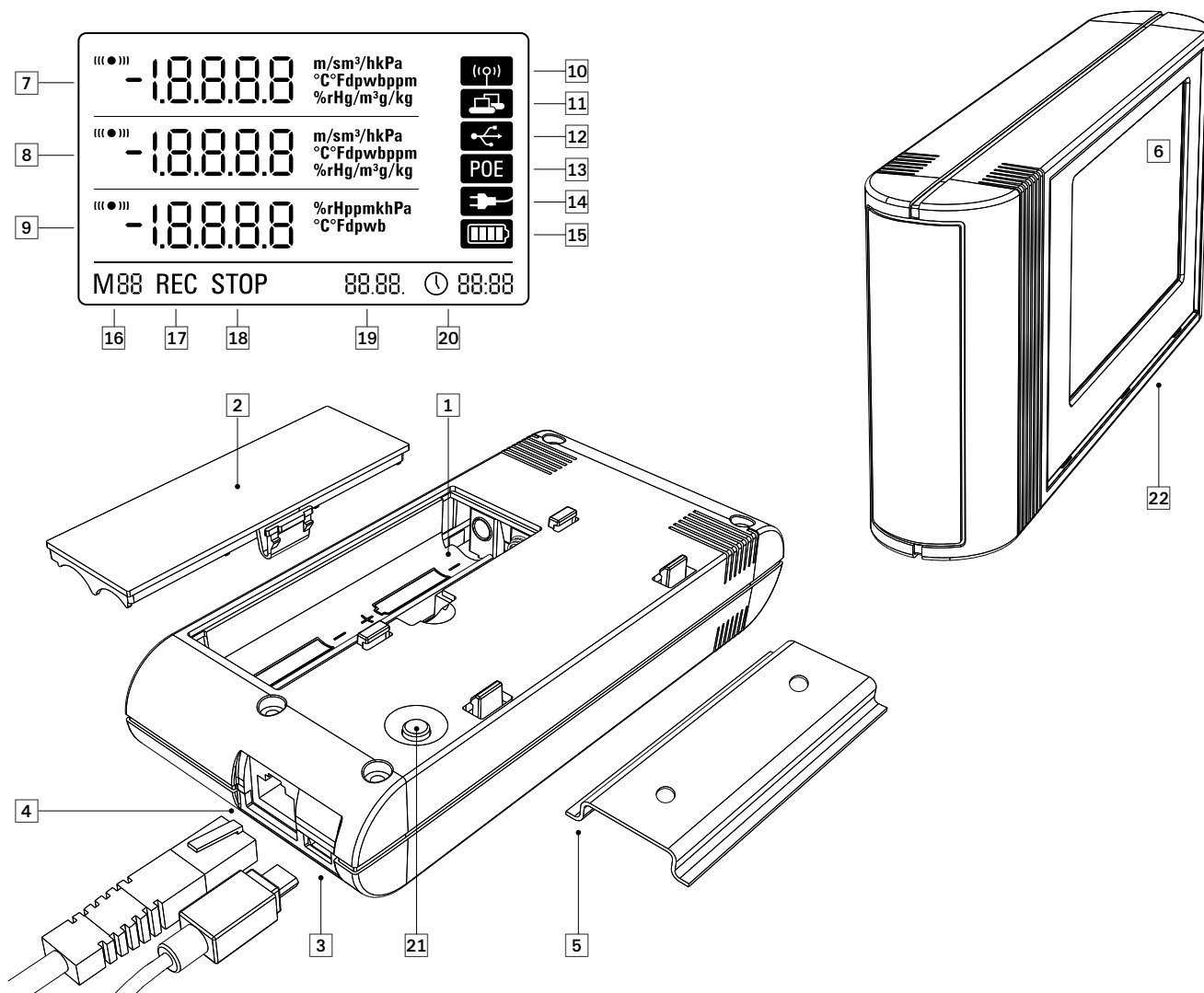

- ① Battery compartment
- ② Battery compartment lid
- ③ USB micro B port
- ④ RJ45 network connection
- ⑤ Mounting rail
- ⑥ LCD display :
 - ⑦ Measuring value line 1
 - ⑧ Measuring value line 2
 - ⑨ Measuring value line 3
 - ⑩ Display symbol acoustic signal active
 - ⑪ Display symbol network connection active
 - ⑫ Display symbol USB connection active
 - ⑬ Display symbol power supply via mains
 - ⑭ Display symbol power supply via USB
 - ⑮ Display symbol battery capacity
 - ⑯ Display symbol mode marker
 - ⑰ Display symbol logging active
 - ⑱ Display symbol logging inactive
 - ⑲ Date display
 - ⑳ Time display
- ⑳ Mode selection key
- ㉑ Data loggers with internal sensors (THI/THIP/TCO)

4. Scope of Delivery

The following components are contained in the standard scope of delivery:

- Data logger
- USB cable
- CD-ROM with operating instructions, SmartGraph software and software manual
- 4 x AA batteries
- Factory certificate

5. Preparations Prior to Use

5.1. Software

5.1.1. Installation Requirements

Your SmartGraph software has to be installed on to a PC that fulfils the following requirements in order for you to be able to configure your data logger and read out the measuring results that have been recorded.

Supported operating systems:

- Windows XP from Service Pack 3 (32 bit or 64 bit version)
- Windows Vista (32 bit or 64 bit version)
- Windows 7 (32 bit or 64 bit version)

Hardware requirements:

- Processor speed: at least 1.0 GHz
- CD ROM drive
- USB or RJ45 network connection
- at least 512 MB main storage
- at least 4 GB free hard disk storage
- Adobe Acrobat Reader software

5.1.2. Installing the SmartGraph-Software

Place the CD ROM in the drive of your PC and follow the instructions of the installation assistant to install the software.

5.1.3 Preparing the Data Logger Configuration

Connect your data logger to your PC with the USB cable included in the scope of delivery. The operating system recognises the data logger automatically.

Alternatively, you may wish to connect your data logger via LAN via your local network. Please make sure that the network function is activated. You will find more information on the network function in chapter 6.2.2.

Start the SmartGraph software. The program recognises the connected data logger automatically and adds the data logger to the existing data logger list. The data logger can now be configured using the software.

You will find more detailed information on the software in the software manual which you can call up using the Help function of your SmartGraph software.

Functions of the professional version

You will find information on the possibility of upgrading your SmartGraph software to the professional version (Device Licence Upgrade) in the software manual.

6. Operating the Data Logger

The SmartGraph PC software forms the central configuration interface for your data logger. All further changes to the configuration or display can only be carried out using the software.

You can use the mode selection keys on your data logger to carry out basic settings directly.

You can also use the software to lock the mode selection keys. In such a case the data logger cannot be configured via the mode selection keys.

6.1. Powering ON/OFF

The data logger cannot be switched off completely when connected to a functioning power supply. It can, however, be switched to a low-energy power mode (M1) which allows it to consume as little power as possible. The data logger is inactive in this mode and therefore unable to carry out measuring or logging or display any values. You will find an overview of the four different modes in the following chapter.

6.2. Basic Settings and Operating Modes

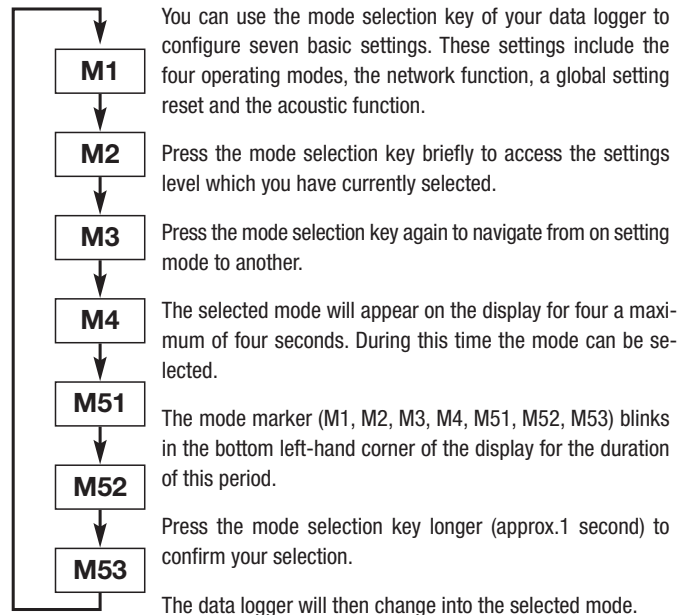

If you do not confirm your selection within this four-second period, then the device will leave the settings level and return to the mode that had previously been selected.

6.2.1. The Four Operating Modes

Operating mode M1

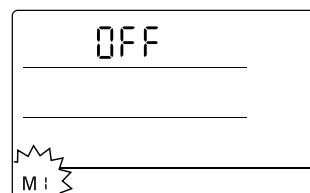

Select operating mode M1

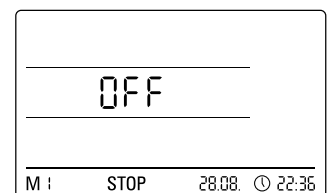

Display operating mode M1

The logging function is inactive. The word "OFF" appears in measuring value line 1. The "STOP" symbol is active.

In this mode (data logger factory setting), the energy consumption is low, because there are not yet any measuring values which could be called up or displayed.

Operating Mode M2

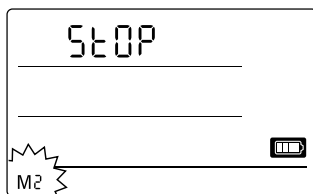

Select operating mode M2

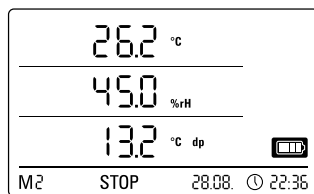

Display example for operating mode M2

The measuring function is active. The measuring values that were configured using the SmartGraph software are displayed in all three measuring value lines together with the previously selected sampling rate. The logging function is not active in this operating mode. The displayed values are not saved into the memory. The word “STOP” (data logging inactive) appears where the saved measuring values are normally displayed.

Operating Mode M3

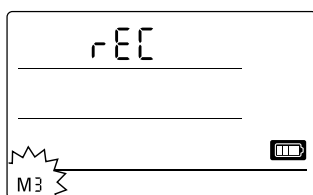

Select operating mode M3

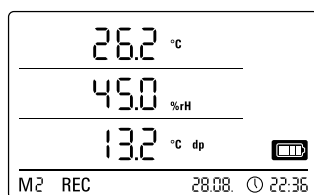

Display example for operating mode M3

The measuring and logging functions are active. The measuring values that were configured using the SmartGraph software are displayed in all three measuring value lines together with the previously selected sampling rate.

In addition a total of 20 measuring channels that have all been previously selected using the SmartGraph software can be saved into the measurement memory. The message “REC” (data logging active) appears where the saved measuring values are normally displayed.

Operating Mode M4

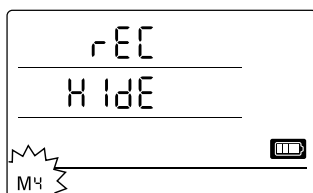

Select operating mode M4

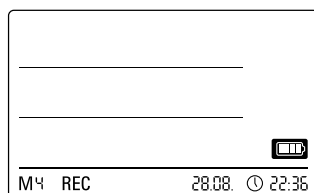

Display operating mode M4

The measuring and logging functions are active. The display is deactivated.

No values are displayed in either of the three lines that normally display measurements. Up to a total of 20 measuring channels, which have all been previously selected using the SmartGraph software, can be saved into the measurement memory. The message “REC” (data logging active) appears where the saved measuring values are normally displayed.

6.2.2. Network Function (M51)

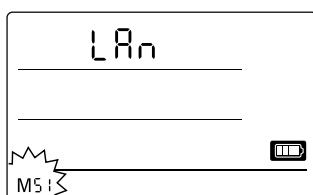

Select network function M51

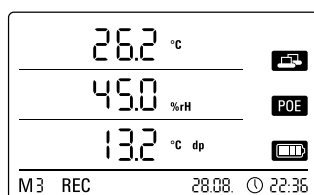

Display example of the network function M51

If the data logger is connected to a local network and the network function is active, then the software can be configured and the data can be read out from the data logger via this network.

A signal transmitted by the data logger via UDP enables the SmartGraph software to find the data logger in the local network automatically.

When the data logger is connected to the network for the first time (add network device), you may have to use the SmartGraph software to adapt the data logger network settings to conform with the existing network configuration. The factory setting is DHCP.

You will find more detailed information on the software in the software manual which you can call up using the Help function of your SmartGraph software.

The professional version of the SmartGraph software also allows you to call up and log current measurements and measuring values that have been saved in the data logger at random intervals via the network.

Use in Network Mode

If you intend to use the network card over a longer period, the data logger must be mounted on a wall. It must be ensured that the air can circulate freely within a minimum distance zone of 50cm around the data logger. This minimum distance zone should also be kept free of external convection sources (fans, lamps etc.).

Power Supply in Network Operation

The data logger consumes more power when the integrated network card is used.

When the network function has been activated, the data logger checks the network status automatically in regular intervals. If an active local network cannot be identified, the data logger deactivates the network function independently after 12 minutes.

There is also an optionally available PoE model. This model can be powered directly from the mains.

6.2.3. Factory Setting (M52)

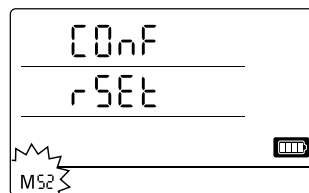

Select reset function M52

This function allows you to reset all the settings of your device to the factory settings.

6.2.4. Acoustic Function (M53)



Select acoustic function M53

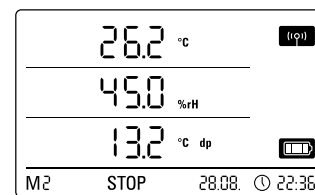

Display example of the acoustic function M53

The data logger has an acoustic signal which can be turned on or off by activating or deactivating the acoustic function. A symbol appears on the display when the acoustic function is activated.

When the acoustic function is activated, an alarm signal alerts the user when an alarm incident occurs. The alarm for one or more than one measurement must have been previously set using the SmartGraph software.

When the acoustic function is activated, the data logger also emits a tone each time the mode selection key is pressed while navigating through the individual levels or when a specific mode is selected. The data logger also emits a tone when you leave the settings level without a previous selection having been made.

7. Measuring Value Display and Data Logging

7.1. Sensors, Channel Groups and Measuring Channels

THI data logger

The THI data logger has two internal sensors with which it can measure values from a total of six channel groups. The channel groups (measured variables) are as follows: air temperature in °C, air temperature in °F, dew point in °C, dew point in °F, relative humidity in % and absolute humidity in g/m³.

Each channel group has four measuring channels with which logging can be performed: current measuring value (act), minimum measuring value (min), maximum measuring value (max) and the average value (avg). This means that your THI data logger has a total of 24 measuring channels, as shown in table 1.

THIP data logger

The THIP data logger has three internal sensors with which it can measure values from a total of eight channel groups. The channel groups (measured variables) are as follows: air temperature in °C, air temperature in °F, dew point in °C, dew point in °F, relative humidity in % and absolute humidity in g/m³, relative air pressure in hPa and absolute air pressure in hPa.

Each channel group has four measuring channels with which logging can be performed: current measuring value (act), minimum measuring value (min), maximum measuring value (max) and the average value (avg). This means that your THIP data logger has a total of 32 measuring channels, as shown in table 1.

TCO data logger

The TCO data logger has three internal sensors with which it can measure values from a total of seven channel groups. The channel groups (measuring variables) are as follows: air temperature in °C, air temperature in °F, dew point in °C, dew point in °F, relative humidity in % and absolute humidity in g/m³ and CO₂ concentration in ppm.

Each channel group has four measuring channels with which logging can be performed: current measuring value (act), minimum measuring value (min), maximum measuring value (max) and the average value (avg). This means that your TCO data logger has a total of 28 measuring channels, as shown in table 1.

7.2. Displaying Measuring Values

Each one of the channel groups as specified in Table 1 can be configured to display measurements in each of the three measuring value lines on the display. The display always shows the current measurement.

7.3. Data Logging

The data logger is in logging mode (REC) when the operating modes M3 or M4 have been selected. The measuring values of the previously selected measuring channels are saved into the logger.

Up to a total of 20 of the measuring channels as specified in Table 1 can be logged into the data memory at the same time.

Logging begins as soon as one of the logging modes M3 or M4 has been selected and continues in ring mode. This means that logging is neither interrupted nor discontinued, because there is no memory limit. The data logger simply writes the latest measurements over the oldest values.



Tip: The current, minimum, maximum and average measuring values of a channel group represent one individual channel. If these values are to be made available for later assessment and documentation, then each of these measuring channels must be selected for logging while you are determining where you would like your data to be saved, as these values cannot be calculated by the software at a later point in time.

The specifications for the type, duration and scope of data logging in logging mode can be selected individually via the software. You will find more detailed information in the software manual.

Table 1 : Overview of sensors, channel groups (measuring variables) and data logger measuring channels

| Sensor / Measuring element | | Channel group (measuring variable) | Unit | Measuring channels available for data logging (max. 20 channels can be saved) and for display* (max. 3 channels can be displayed) | | | | Can be displayed in measuring value line |
|----------------------------|--------------------------------|------------------------------------|---------------------|---|-----|-----|------|--|
| all models | internal temperature sensor | temperature | [°C] | act | min | max | avg | 1, 2, 3 |
| | | temperature | [°F] | act | min | max | avg | 1, 2, 3 |
| | | dew point | [°C] | act | min | max | avg | 1, 2, 3 |
| | | dew point | [°F] | act | min | max | avg | 1, 2, 3 |
| | internal humidity sensor | rel. humidity | [%] | act | min | max | avg | 1, 2, 3 |
| | | abs. humidity | [g/m ³] | act | min | max | avg | 1, 2 |
| only THIP | internal air pressure sensor | rel. air pressure** | [hPa] | act | min | max | mitt | 1, 2, 3 |
| | | abs. air pressure | [hPa] | act | min | max | mitt | 1, 2, 3 |
| only TCO | internal carbon dioxide sensor | CO ₂ concentration** | [ppm] | act | min | max | mitt | 1, 2, 3 |

* When a channel is selected to be shown on the display, the current measuring value (act) is always displayed automatically.

** In order to be able to determine the measuring value accurately, the height of the location must first be entered using the SmartGraph software.

8. Alarm Function

8.1. Alarm Configuration

The data logger management can be used to configure an alarm for each individual measuring channel which has been selected for display or logging.

First you must define both an upper and a lower alarm threshold so as to set a corridor within which the values are deemed to be good. The data logger triggers the alarm as soon as the measured value is outside this corridor, i.e. one of the thresholds has been exceeded.

Please note: The alarm function will only be displayed for the channel groups of the three measuring channels which have been previously selected to be displayed and only in the operating modes M2 and M3!

Alarm incidents of further selected measuring channels in logging mode are saved regardless whether they have been selected to be displayed or not. This means that alarm incidents of measuring channels that have not been selected for display but which have been selected for logging will be saved.

All selected alarm incidents are also recorded when the display has been deactivated in operating mode M4.

8.2. Alarm Symbol on the Display

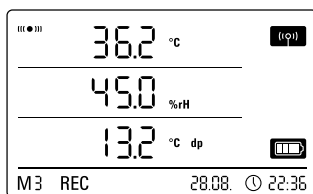

Display example for an alarm incident of the measuring channel displayed in the first measurement line.

The alarm will only appear on the display for measuring values which have been selected to be displayed and which have been configured with an active alarm function. When an alarm has been triggered on one of these measuring channels, an alarm symbol appears next to the measuring value for this specific channel. The symbol continues to blink until the measured value returns to the preset corridor.

The alarm symbol stops blinking as soon as the measured value is within the selected thresholds. The alarm symbol remains on the display.

This is to show the user that an alarm has been triggered and that an alarm incident has occurred. If the threshold values are exceeded again, then the alarm symbol starts to blink again.

The alarm symbol disappears when the memory is read out.

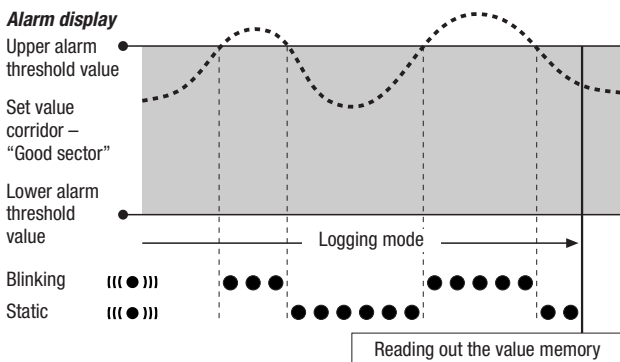

A hysteresis can also be set which switches off the alarm when the measured value is once again within the corridor.

8.3. Acoustic Alarm

When an alarm is triggered when the acoustic function is active (see chapter 6.2.4. Acoustic Function), an alarm tone sounds in addition to the alarm symbol on the display. The logger stops emitting the tone when the measured value is within the corridor.

8.4. Using the Alarm Hysteresis

If you use the alarm function with an alarm hysteresis, the alarm will be triggered and recorded every time the alarm thresholds are exceeded.

If the corridor between the selected alarm thresholds is very narrow, the alarm will be triggered more often.

If, for example, you have selected 24 °C as your upper alarm threshold for the room temperature and 10 °C for your lower alarm threshold and the room temperature fluctuates between 23.5 and 25 °C during the entire measuring period, then this would lead to the alarm being triggered and recorded much more often than would perhaps otherwise be the case during a normal measuring period.

In order to prevent this from happening, you can set an alarm hysteresis. By doing so you are defining a value which has to be reached in the selected value corridor, the so-called "good sector" to switch off the alarm.

The alarm hysteresis is set to 1 °C in the previous example. This means that the alarm will be triggered when the measured value has exceeded 24 °C and then switched off again when it reaches 23 °C.

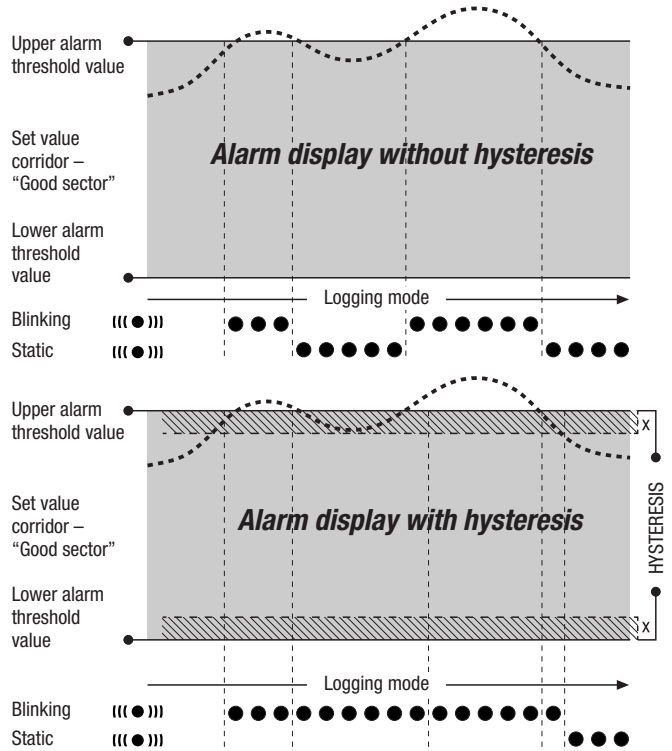

9. Cleaning and Maintenance Instructions

9.1. Replacing the Batteries

When the message “LO bAtt” appears on the display, the batteries have to be replaced.



The data logger cannot log data while the batteries are being replaced. If you have to interrupt a logging process, please ensure that the data logger is set to operating mode M1 or M2 before the batteries are replaced.

Open the battery compartment and remove the used batteries. Place the new batteries in the battery compartment. Make sure that the poles are properly aligned.

The clock continues to give the correct time for at least a minute while the batteries are being replaced.

Only use batteries which are permissible according to the technical specifications. Other battery types can cause faults. Do NOT use rechargeable batteries!

Do NOT dispose of used batteries in your household waste. Do NOT throw into an open fire or water. Please dispose of these batteries in a proper manner in accordance with existing regulations.

9.2. Installation During Mobile Operation

The data logger can be placed at any random position during mobile operation. Please make sure that the permissible environmental conditions are observed (see Technical Data). Because of its compact size, the data logger can be easily concealed during mobile operation.

9.3. Mounting the Logger on a Wall

If stationary logging is to be carried out, the data logger can be mounted on wall or fixed to a mounting rail. There is a mounting rail included in the scope of delivery.



The wall mount must be used if the logger is being used in network operation. You will find more information on network operation in chapter 6.2.2.

9.4. Changing Locations

A change of location, i.e. from a cold to a warm place (for example when the device has been left in a car overnight before being brought into a warm room for measuring), can lead to condensation forming on the printed circuit board.

This physical phenomenon, which cannot be avoided through any change in the construction of such a measuring device, will invariably lead to incorrect readings. Please wait approximately 5 minutes to give the device enough time to adapt to its new surroundings before carrying out measuring.

10. Technical Data

| Technical Data | | THI | THIP | TCO |
|--|--------------------|---|---|--|
| Air temperature | Principle | NTC | | |
| | Measuring range | -20 °C to + 50 °C | | |
| | Accuracy | ± 0.3 °C (0...40 °C), otherwise 0.5 °C | | |
| | Display resolution | 0.1 °C | | |
| Rel. humidity | Principle | capacitive | | |
| | Measuring range | 10 to 95 % RH | | |
| | Accuracy | ±2 % RH | | |
| | Display resolution | 0.5 % RH | | |
| Air pressure | Measuring range | – | 300 ... 1,300 hPa abs. | – |
| | Accuracy | – | 700 ... 1,100 mbar at 25 °C ±0.5 hPa | – |
| | Display resolution | – | 0.1 hPa | – |
| CO ₂ concentration | Principle | – | – | NDIR |
| | Measuring range | – | – | 0 ... 5,000 ppm |
| | Accuracy | – | – | ±50 ppm +3 measuring value at 20 °C and 1,013 mbar |
| | Display resolution | – | – | 1 ppm |
| | long-time stable | – | – | 20 ppm/a |
| Memory organisation | Sampling interval | 10/30 s, 1/10/12/15/30 min, 1/3/6/12/24 h | | |
| | Memory interval | 1/10/12/15/30 min, 1/3/6/12/24 h | | |
| | Data memory | 16 MB, 3,200,000 measuring values | | |
| | Data logging | up to 20 measuring channels parallel | | |
| Features and dimensions | LCD display | W 90 x H 64 mm | | |
| | Casing | Synthetic material | | |
| | Dimensions | L 166 x W 32 x H 78 mm | | |
| | Weight | approx. 250 g | | |
| | Interface | USB, LAN | | |
| Power supply | internal | 4 x LR6 AA mignon batteries, battery life > 1 year | | |
| | external | USB, LAN (PoE model) | | |
| Permissible operational environmental conditions | Air temperature | -20 °C to +50 °C | | |
| | rel. humidity | 0 to 95 % RH, < 20 g/m ³ (non-condensing) | | |
| | Height | 10,000 m above MSL | | |
| Scope of delivery | Standard | Data logger, CD ROM with SmartGraph 3 PC software for graphic and numerical display of measurement assessments and operating instructions, USB cable, batteries | | |
| | Optional | PoE model | | |