

# Arbitrary Function Generator

AFG-2000 Series

---

## USER MANUAL

GW INSTEK PART NO. 82AF-21200EC1



ISO-9001 CERTIFIED MANUFACTURER

**GW INSTEK**

This manual contains proprietary information, which is protected by copyright. All rights are reserved. No part of this manual may be photocopied, reproduced or translated to another language without prior written consent of Good Will Corporation.

The information in this manual was correct at the time of printing. However, Good Will continues to improve its products and therefore reserves the right to change the specifications, equipment, and maintenance procedures at any time without notice.

**Good Will Instrument Co., Ltd.**  
**No. 7-1, Jhongsing Rd., Tucheng Dist., New Taipei City 236, Taiwan.**

# Table of Contents

|  |           |
|--|-----------|
| <b>SAFETY INSTRUCTIONS</b> .....                                   | <b>3</b>  |
| <b>GETTING STARTED</b> .....                                       | <b>8</b>  |
| Main Features .....  | 8         |
| Panel Overview.....  | 10        |
| Setting up the Function Generator .....                            | 16        |
| <b>QUICK REFERENCE</b> .....                                       | <b>18</b> |
| How to use the Digital Inputs .....                                | 19        |
| Selecting a Waveform .....   | 21        |
| ARB.....   | 23        |
| Modulation.....  | 24        |
| Sweep (2100 series only) .....                                     | 28        |
| Counter (2100 series only) .....                                   | 30        |
| Save/Recall.....   | 31        |
| Default Settings .....   | 32        |
| <b>OPERATION</b> .....   | <b>34</b> |
| Select a Waveform .....  | 36        |
| Setting the Frequency .....  | 36        |
| Setting the Amplitude.....   | 37        |
| Setting the DC Offset .....  | 38        |
| Setting the Duty Cycle/Symmetry .....                              | 39        |
| Setting the Output Impedance .....                                 | 41        |
| Turning the Output On .....  | 42        |
| Amplitude Modulation (AM) (AFG-2100 Series) .....                  | 43        |
| Frequency Modulation (FM) (AFG-2100 Series).....                   | 51        |
| Frequency Shift Keying (FSK) Modulation (AFG-2100 Series)<br>..... | 59        |
| Frequency Sweep (AFG-2100 Series).....                             | 67        |
| Creating an Arbitrary Waveform .....                               | 73        |

Using the Frequency Counter .....75  
 Using the SYNC Output Port .....77  
 Save and Recall State/ARB Waveform .....81

**REMOTE INTERFACE..... 83**

Selecting the USB Remote Interface .....85  
 Command Syntax.....86  
 Command List .....92  
 System Commands .....94  
 Status Register Commands.....95  
 Apply Commands .....96  
 Output Commands .....102  
 Amplitude Modulation (AM) Commands .....110  
 AM Overview .....110  
 Frequency Modulation (FM) Commands.....114  
 FM Overview .....114  
 Frequency-Shift Keying (FSK) Commands .....119  
 FSK Overview .....119  
 Frequency Sweep Commands.....123  
 Sweep Overview .....123  
 Frequency Counter Commands .....128  
 Arbitrary Waveform Commands .....130  
 Arbitrary Waveform Overview .....130  
 Save and Recall Commands .....133

**APPENDIX..... 135**

Error Messages .....135  
 AFG-2000 Series Specifications .....137  
 EC Declaration of Conformity .....141

**INDEX..... 142**

# S SAFETY INSTRUCTIONS

This chapter contains important safety instructions that should be followed when operating and storing the function generator. Read the following before any operation to ensure your safety and to keep the function generator in the best condition.

## Safety Symbols

These safety symbols may appear in this manual or on the instrument.

---



WARNING

Warning: Identifies conditions or practices that could result in injury or loss of life.



CAUTION

Caution: Identifies conditions or practices that could result in damage to the function generator or to other objects or property.



DANGER High Voltage



Attention: Refer to the Manual



Protective Conductor Terminal



Earth (Ground) Terminal



DANGER Hot Surface



Double Insulated



Do not dispose electronic equipment as unsorted municipal waste. Please use a separate collection facility or contact the supplier from which this instrument was purchased.

## Safety Guidelines

---

General  
Guideline



CAUTION

- Do not place heavy objects on the instrument.
- Do not place flammable objects on the instrument.
- Avoid severe impact or rough handling that may damage the function generator.
- Avoid discharges of static electricity on or near the function generator.
- Use only mating connectors, not bare wires, for the terminals.
- The instrument should only be disassembled by a qualified technician.

(Measurement categories) EN 61010-1:2010 specifies the measurement categories and their requirements as follows. The instrument falls under category II.

- Measurement category IV is for measurement performed at the source of a low-voltage installation.
- Measurement category III is for measurement performed in a building installation.
- Measurement category II is for measurement performed on circuits directly connected to a low voltage installation.
- Measurement category I is for measurements performed on circuits not directly connected to Mains.

Power Supply



WARNING

- AC Input voltage: 100 ~ 240V AC, 50 ~ 60Hz.
- Connect the protective grounding conductor of the AC power cord to an earth ground to prevent electric shock.

---

Fuse



WARNING

- Fuse type: F1A/250V.
  - Only qualified technicians should replace the fuse.
  - To ensure fire protection, replace the fuse only with the specified type and rating.
  - Disconnect the power cord and all test leads before replacing the fuse.
  - Make sure the cause of fuse blowout is fixed before replacing the fuse.
- 

Cleaning the  
function  
generator

- Disconnect the power cord before cleaning the function generator.
  - Use a soft cloth dampened in a solution of mild detergent and water. Do not spray any liquid into the function generator.
  - Do not use chemicals containing harsh products such as benzene, toluene, xylene, and acetone.
- 

Operation  
Environment

- Location: Indoor, no direct sunlight, dust free, almost non-conductive pollution (Note below) and avoid strong magnetic fields.
- Relative Humidity: < 80%
- Altitude: < 2000m
- Temperature: 0°C to 40°C

(Pollution Degree) EN 61010-1:2010 specifies pollution degrees and their requirements as follows. The function generator falls under degree 2.

Pollution refers to “addition of foreign matter, solid, liquid, or gaseous (ionized gases), that may produce a reduction of dielectric strength or surface resistivity”.

- Pollution degree 1: No pollution or only dry, non-conductive pollution occurs. The pollution has no influence.
  - Pollution degree 2: Normally only non-conductive pollution occurs. Occasionally, however, a temporary conductivity caused by condensation must be expected.
  - Pollution degree 3: Conductive pollution occurs, or dry, non-conductive pollution occurs which becomes conductive due to condensation which is expected. In such conditions, equipment is normally protected against exposure to direct sunlight,
-

precipitation, and full wind pressure, but neither temperature nor humidity is controlled.

---

Storage environment

- Location: Indoor
  - Relative Humidity: < 70%
  - Temperature: -10°C to 70°C
- 

Disposal



Do not dispose this instrument as unsorted municipal waste. Please use a separate collection facility or contact the supplier from which this instrument was purchased. Please make sure discarded electrical waste is properly recycled to reduce environmental impact.



## Power cord for the United Kingdom

When using the function generator in the United Kingdom, make sure the power cord meets the following safety instructions.

NOTE: This lead/appliance must only be wired by competent persons



**WARNING: THIS APPLIANCE MUST BE EARTHED**

IMPORTANT: The wires in this lead are coloured in accordance with the following code:

|                |              |
|----------------|--------------|
| Green/ Yellow: | Earth        |
| Blue:          | Neutral      |
| Brown:         | Live (Phase) |



As the colours of the wires in main leads may not correspond with the coloured marking identified in your plug/appliance, proceed as follows:

The wire which is coloured Green & Yellow must be connected to the Earth terminal marked with either the letter E, the earth symbol  $\oplus$  or coloured Green/Green & Yellow.

The wire which is coloured Blue must be connected to the terminal which is marked with the letter N or coloured Blue or Black.

The wire which is coloured Brown must be connected to the terminal marked with the letter L or P or coloured Brown or Red.

If in doubt, consult the instructions provided with the equipment or contact the supplier.

This cable/appliance should be protected by a suitably rated and approved HBC mains fuse: refer to the rating information on the equipment and/or user instructions for details. As a guide, a cable of 0.75mm<sup>2</sup> should be protected by a 3A or 5A fuse. Larger conductors would normally require 13A types, depending on the connection method used.

Any exposed wiring from a cable, plug or connection that is engaged in a live socket is extremely hazardous. If a cable or plug is deemed hazardous, turn off the mains power and remove the cable, any fuses and fuse assemblies. All hazardous wiring must be immediately destroyed and replaced in accordance to the above standard.

# GETTING STARTED

The Getting started chapter introduces the function generator's main features, appearance and introduces a quick instructional summary of some of the basic functions. For comprehensive operation instructions, please see the operation chapter.

## Main Features

| Model name        | AFG-2005   | AFG-2105 | AFG-2012    | AFG-2112 | AFG-2025    | AFG-2125 |
|-------------------|--|----------|-------------|----------|-------------|----------|
| Frequency Range   | 0.1Hz~5MHz   |          | 0.1Hz~12MHz |          | 0.1Hz~25MHz |          |
| Output waveform   | Sine, Square, Ramp, Noise, ARB                                 |          |             |          |             |          |
| Amplitude range   | 0.1Hz~20MHz  |          |             |          |             |          |
|                   | 1 mVpp to 10 Vpp (into 50Ω)<br>2 mVpp to 20 Vpp (open-circuit) |          |             |          |             |          |
|                   | 20MHz~25MHz  |          |             |          |             |          |
|                   | 1 mVpp to 5 Vpp (into 50Ω)<br>2 mVpp to 10 Vpp (open-circuit)  |          |             |          |             |          |
| Variable Offset   | ✓  | ✓        | ✓           | ✓        | ✓           | ✓        |
| Variable Duty     | ✓  | ✓        | ✓           | ✓        | ✓           | ✓        |
| SYNC (TTL) output | ✓  | ✓        | ✓           | ✓        | ✓           | ✓        |
| Save/Recall       | ✓  | ✓        | ✓           | ✓        | ✓           | ✓        |
| Sweep operation   | —  | ✓        | —           | ✓        | —           | ✓        |
| AM                | —  | ✓        | —           | ✓        | —           | ✓        |
| FM                | —  | ✓        | —           | ✓        | —           | ✓        |
| FSK               | —  | ✓        | —           | ✓        | —           | ✓        |
| Frequency Counter | —  | ✓        | —           | ✓        | —           | ✓        |

---

|               |   |   |   |   |   |   |
|---------------|---|---|---|---|---|---|
| ARB           | ✓ | ✓ | ✓ | ✓ | ✓ | ✓ |
| USB Interface | ✓ | ✓ | ✓ | ✓ | ✓ | ✓ |

---

- Performance
- DDS technology using an FPGA provides high resolution waveforms
  - 25MHz DDS (Direct Digital Synthesis) signal output series
  - 0.1Hz resolution
  - Full Function Arbitrary Waveform Capability
    - 20 MSa/s sample rate
    - 10 MHz repetition rate
    - 4 k-point waveform length
    - 10-bit amplitude resolution
    - Ten 4k waveform memories
- 

- Features
- Sine, Square, Ramp, Noise
  - Int/Ext AM, FM, FSK modulation
  - Modulation/sweep signal output
  - Save/recall 10 groups of setting memories
  - Output overload protection
  - ARB (Arbitrary Waveform) can be edited with PC software
- 

- Interface
- USB interface as standard
  - 3.5 inch LCD





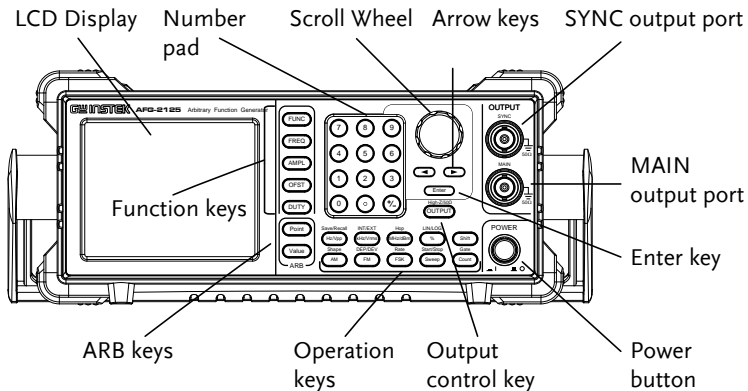



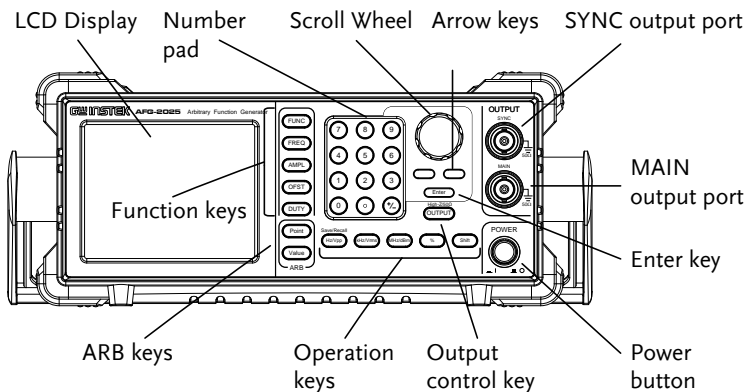

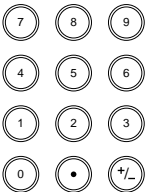
## Panel Overview

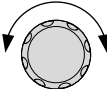

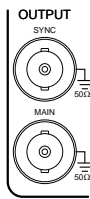



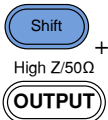















### AFG-2105/2112/2125 Front Panel



### AFG-2005/2012/2025 Front Panel





|                    |  |
|--------------------|--|
| LCD display        | 3.5 inch, 3 color LCD display.   |
| Keypad             |  <p>The digital keypad is used to enter values and parameters. The keypad is often used in conjunction with the selection keys and variable knob.</p>   |
| Scroll Wheel       |  <p>The scroll wheel is used to edit values and parameters in steps of 1 digit. Used in conjunction with the arrow keys.</p> <div style="text-align: center;">  <p>Decrease      Increase</p> </div> |
| Arrow keys         |  <p>Used to select digits when editing parameters.</p>  |
| Output ports       |  <p>SYNC output port (50Ω impedance).<br/>Main output port (50Ω impedance).</p>   |
| Enter key          |  <p>Used to confirm input values.</p>  |
| Power button       |  <p>Turns the instrument power on/off.</p>  |
| Output control key |  <p>Turns the output on/off.</p>  |
| Output Impedance   |  <p>Toggles the output impedance between 50Ω and High-Z.</p>  |
| Operation keys     |  <p>Selects Hz or Vpp units.</p>  |

|   |   |   |  |
|---|---|---|--|
|    | + |          | Saves or recalls waveforms from memory.  |
|   |   |          | Selects kHz or Vrms units.   |
|    | + |          | Sets the source to internal or external for the modulation and FSK functions*. |
|   |   |          | Selects MHz or dBm units.  |
|    | + |          | Sets the "Hop" frequency for FSK modulation*.                                  |
|   |   |  | Selects % units.   |
|    | + |          | Sets the sweep to linear or logarithmic*.                                      |
|   |   |          | The shift key is used to select the secondary functions on the operation keys. |
|   |   |          | The AM key is used to turn AM modulation on/off*.                              |
|    | + |          | Selects the modulation waveform*.  |
|   |   |        | The FM key is used to turn FM modulation on/off*.                              |
|  | + |        | Selects the modulation depth or the frequency deviation*.                      |
|   |   |        | Selects FSK modulation*.   |
|  | + |        | Sets the AM, FM, FSK modulation and sweep function rate*.                      |
|   |   |        | Selects the Sweep function*.   |

 +  Sets the Start or Stop frequency\*.

 Turns the frequency counter on/off\*.

 +  Sets the frequency counter gate time\*.

**ARB edit keys**

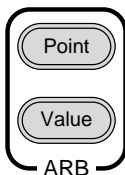

Arbitrary waveform editing keys.  
 The Point key sets the ARB point numbers.  
 The Value key sets the amplitude value of the selected point.

**Function keys**



The FUNC key is used to select the output waveform type: Sine, Square, Ramp, Noise, ARB.



Sets the frequency of the selected waveform.



Sets the amplitude of the selected waveform.



The OFST sets the DC offset for the selected waveform.



The DUTY key sets the duty cycle of square and ramp waveforms.



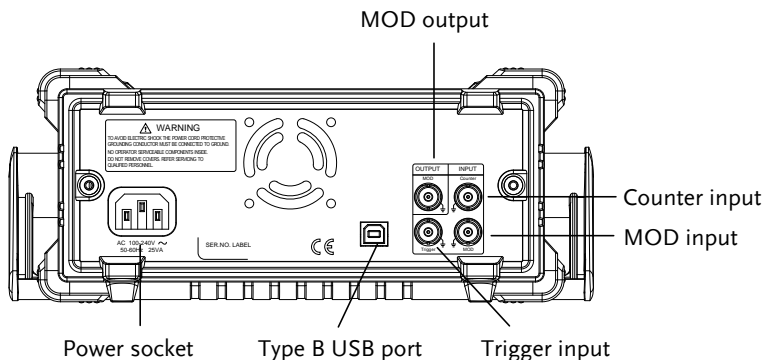

\*indicates functions/features for the AFG-2105/2112/2125 only.

### AFG-2105/2112/2125 Rear Panel

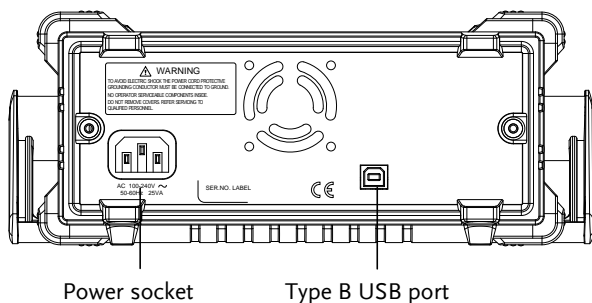

### AFG-2005/2012/2025 Rear Panel

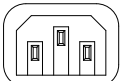

|                    |  |   |
|--------------------|--|---|
| MOD output         |                                    | Modulation output port.   |
| Counter input      |                                    | Counter input port.   |
| MOD input          |                                   | Modulation input port.  |
| Trigger input      |                                   | Trigger input port.   |
| Type B USB port    |                                   | The type B USB port is used to connect the function generator to a PC for remote control. |
| Power Socket Input | <br>AC 100-240V ~<br>50-60Hz 25VA | Power input: 100~240V AC<br>50~60Hz.  |



Display

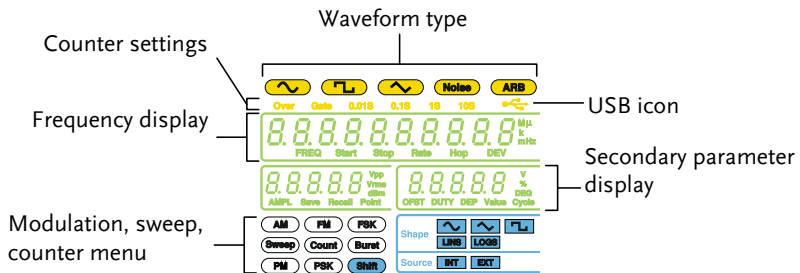

Waveform type    **Noise** **ARB**

Press the function key to cycle through different output waveforms.

Counter settings **Over Gate 0.01S 0.1S 1S 10S**

Gate time counter settings\*.

USB icon  Shows the USB interface status.

Frequency Display 

Displays the main waveform frequency settings.

Secondary parameter display 

Displays secondary waveform parameters and settings.

Modulation, sweep, counter menu 

Displays the modulation, sweep and counter functions as well as the modulating waveform and source\*.

\*indicates functions/features for the AFG-2105/2112/2125 only.

## Setting up the Function Generator

**Background** This section describes how adjust the handle and power up the function generator.

**Adjusting the stand** Pull out the handle sideways and rotate it.

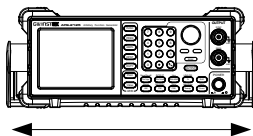

Place the AFG horizontally.

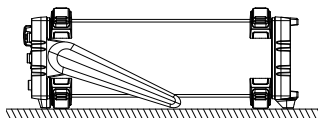

Place the handle upright to tilt the stand.

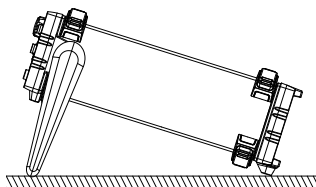

Place the handle vertically to hand carry.

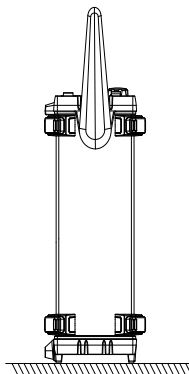

## Power Up

1. Connect the power cord to the socket on the rear panel.

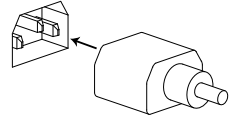

2. Press the power button on the front panel.



3. The instrument will turn on and load the default settings (see page 32 for default settings).

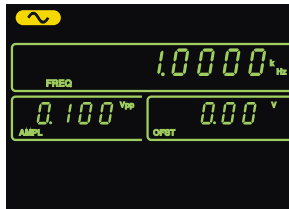

The function generator is now ready to be used.

# QUICK REFERENCE

This chapter lists operation shortcuts and default factory settings. Use this chapter as a handy reference for instrument functions. This chapter is to be used as a quick reference; for detailed explanations on parameters, settings and limitations, please see the operation chapter (page 34) or specifications (page 137).

---

|   |    |
|---|----|
| How to use the Digital Inputs .....     | 19 |
| Selecting a Waveform .....              | 21 |
| Sine Wave.....                          | 21 |
| Square Wave .....                       | 21 |
| Ramp Wave .....                         | 22 |
| ARB .....                               | 23 |
| ARB - Points .....                      | 23 |
| Modulation.....                         | 24 |
| AM (2100 series only) .....             | 24 |
| FM (2100 series only) .....             | 25 |
| FSK Modulation (2100 series only) ..... | 26 |
| Sweep (2100 series only) .....          | 28 |
| Counter (2100 series only) .....        | 30 |
| Save/Recall.....                        | 31 |
| Save .....                              | 31 |
| Recall .....                            | 31 |
| Default Settings.....                   | 32 |

# How to use the Digital Inputs

**Background**

The AFG-2000 has three main types of digital inputs: the number pad, arrow keys and the scroll wheel. The following instructions will show you how to use the digital inputs to edit parameters.

1. First select the function that must be edited pressing one of the function or ARB keys. The selected function will flash.

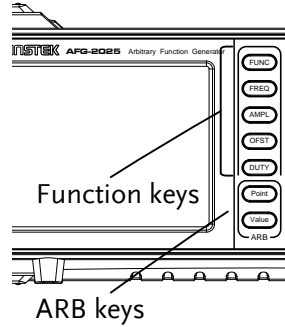

2. To edit a parameter, use the

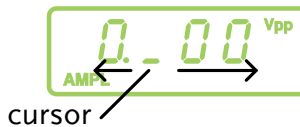

3. Use the scroll wheel to increment the parameter by the resolution of the digit under the cursor.

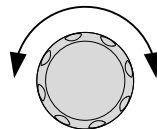

In the example above, the scroll wheel will increment the parameter in 0.1 volt increments.

Clockwise increases the value, counterclockwise decreases the value.

4. Press the Enter key to confirm the new parameter value.

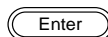

5. Alternatively, the number pad can be used to set the value of the selected parameter.

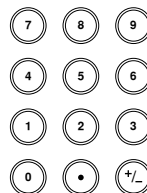

6. To finish editing with the number pad, select the unit with one of the unit keys. (Hz, kHz, MHz, Vpp, Vrms, dBm, %)

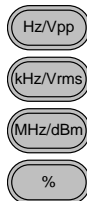

## Selecting a Waveform

### Sine Wave

Example: Sine Wave, 10kHz, 1Vpp, 2Vdc

Output

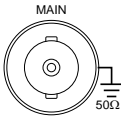

1. Press the **FUNC** key repeatedly to select the Sine wave.



2. Press **FREQ > 1 > 0 > kHz**.



3. Press **AMPL > 1 > Vpp**.



4. Press **OFST > 2 > Vpp**.



5. Press the **OUTPUT** key.



### Square Wave

Example: Square Wave, 10kHz, 3Vpp, 75% duty cycle

Output

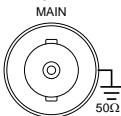



1. Press the **FUNC** key repeatedly to select the Square wave.



2. Press **FREQ > 1 > 0 > kHz**.





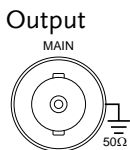

3. Press **AMPL > 3 > Vpp.** 
4. Press **DUTY > 7 > 5 > %.** 
5. Press the output  key.

## Ramp Wave

Example: Ramp Wave, 10kHz, 3Vpp, 25% symmetry



1. Press the **FUNC**  key repeatedly to select the Ramp wave.
2. Press **FREQ > 1 > 0 > kHz.** 
3. Press **AMPL > 3 > Vpp.** 
4. Press **DUTY > 2 > 5 > %.** 
5. Press the **OUTPUT**  key.









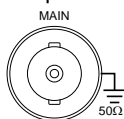

# ARB

## ARB - Points

Example: 2 ARB points, 10 kHz, 1Vpp.

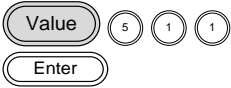
Output

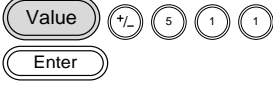

1. Press the **FUNC** key repeatedly to select the ARB wave.
 
2. Press **FREQ > 1 > 0 > kHz**.
 
3. Press **AMPL > 1 > Vpp**.
 
4. Press **Point > 0 > Enter**.
 
5. Press **Value > 5 > 1 > 1 > Enter**.
 
6. Press **Point > 1 > Enter**.
 
7. Press **Value > ± > 5 > 1 > 1 > Enter**.  
(-511)
 
8. Press the **OUTPUT** key.
 

# Modulation

## AM (2100 series only)

Example: AM modulation. 100Hz modulating square wave. 1 Vpp, 1kHz Sine wave carrier. 70% modulation depth. Internal source signal.

Output

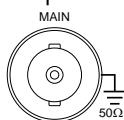

1. Press the **FUNC** key repeatedly to select the Sine wave.



2. Press **FREQ > 1 > kHz**.



3. Press **AMPL > 1 > Vpp**.



4. Press **AM**.



5. Press **Shift > INT/EXT > select INT** source.

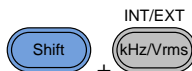

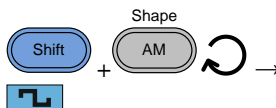

6. Press **Shift > Shape** repeatedly to select the **Square wave**.

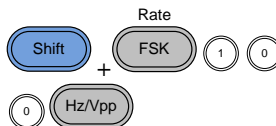

7. Press **Shift > Rate > 1 > 0 > 0 > Hz**.

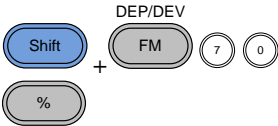





8. Press **Shift** > **DEP/DEV** > **7** > **0** > %.  

9. Press the **OUTPUT** key.  

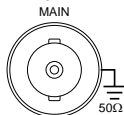
10. Press **AM** again to deselect the AM function.  

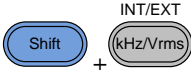

### FM (2100 series only)

Example: FM modulation. 100Hz modulating square wave. 1Vpp, 1kHz Sine wave carrier. 100 Hz frequency deviation. Internal Source.

Output



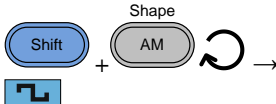
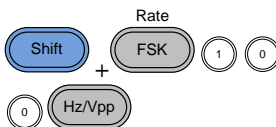
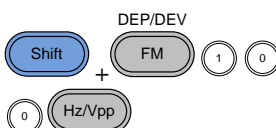



1. Press the **FUNC** key repeatedly to select the Sine wave.  

2. Press **FREQ** > **1** > kHz.  

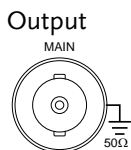
3. Press **AMPL** > **1** > Vpp.  

4. Press **FM**.  

5. Press **Shift** > **INT/EXT** > select **INT** source.  

















6. Press **Shift > Shape** repeatedly to select **Square wave**.
 
7. Press **Shift > Rate > 1 > 0 > 0 > Hz**.
 
8. Press **Shift > DEP/DEV > 1 > 0 > 0 > Hz**.
 
9. Press the **OUTPUT** key.
 
10. Press **FM** again to deselect the AM function.
 

### FSK Modulation (2100 series only)

Example: FSK modulation. 10Hz Hop frequency. 1Vpp, 1kHz Ramp carrier wave. 100 Hz Rate (modulation frequency). Internal Source.



1. Press the **FUNC** key repeatedly to select the **Ramp** wave.
 
2. Press **FREQ > 1 > kHz**.
 
3. Press **AMPL > 1 > Vpp**.
 

4. Press **FSK**. 
  
5. Press **Shift > INT/EXT > select INT source**.  + 
  
6. Press **Shift > Rate > 1 > 0 > 0 > Hz**.  +     
 
  
7. Press **Shift > Hop > 1 > 0 > Hz**.  +     

  
8. Press the **OUTPUT** key. 
  
9. Press **FSK** again to deselect the FSK function. 

## Sweep (2100 series only)

Example: Frequency Sweep. Start Frequency 1Hz, Stop Frequency 1MHz. 1Hz Rate. 1Vpp. Linear Sweep.

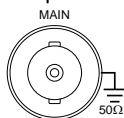
Output



1. Press the **FUNC** key repeatedly to select the **Ramp** wave.



2. Press **AMPL > 1 > Vpp**.



3. Press **Sweep**.



4. Press **Shift > INT/EXT > select INT** source.

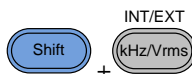

5. Press **Shift > Start/Stop select Start > 1 > Hz**.

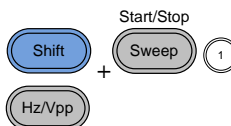

6. Press **Shift > Start/Stop select Stop > 1 > MHz**.

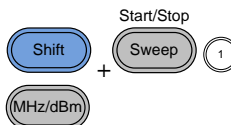

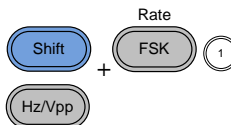

7. Press **Shift > Rate > 1 > Hz**.

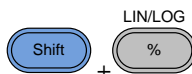

8. Press **Shift > LIN/LOG > select LINS**.







9. Press the **OUTPUT**  key.
10. Press **Sweep** again  to deselect the sweep function.

## Counter (2100 series only)

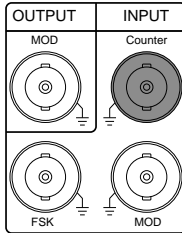
Example: Frequency counter function, gate time 1s.

Input



1. Press the **Count** key. 
2. Press **Shift > Gate** repeatedly to select the **1S** gate time.  + 
3. Connect the signal to the counter input signal.
4. Press **Count** again to deselect the counter function. 





## Save/Recall

### Save

---

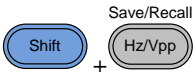
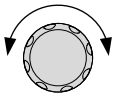
Example: Save waveform to memory.

1. Press **Shift** > **Save/Recall**. Select **Save**.  

2. Turn the scroll wheel and choose a save number.  

3. Press **Enter** to confirm the save file number.  

### Recall

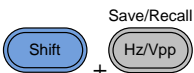
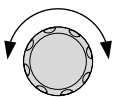
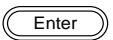
---

Example: Recall waveform from memory.

1. Press **Shift** > **Save/Recall**. Select **Recall**.  

2. Turn the scroll wheel and choose a saved file number.  

3. Press Enter to confirm the recall.  

## Default Settings

The default settings appear each time the power is turned on.

|                           |                      |                 |
|---------------------------|----------------------|-----------------|
| Output Config.            | Function             | Sine wave       |
|                           | Frequency            | 1kHz            |
|                           | Amplitude            | 100mVpp         |
|                           | Offset               | 0.00Vdc         |
|                           | Output units         | Vpp             |
|                           | Output terminal      | 50Ω             |
|                           | Output impedance     | 50Ω             |
| Modulation<br>(AM/FM/FSK) | Carrier Wave         | 1kHz Sine wave  |
|                           | Modulation waveforms | 100Hz Sine wave |
|                           | AM Depth             | 100%            |
|                           | FM Deviation         | 10Hz            |
|                           | FSK Hop Frequency    | 100Hz           |
|                           | FSK Frequency        | 500Hz           |
|                           | Modulation Status    | Off             |
| Sweep                     | Start/Stop frequency | 100Hz/1kHz      |
|                           | Sweep time           | 1s              |
|                           | Sweep rate           | 100Hz           |
|                           | Sweep type           | Linear          |
|                           | Sweep status         | Off             |

|                   |                       |            |
|-------------------|-----------------------|------------|
| System settings   | Power off signal      | On         |
|                   | Display mode          | On         |
|                   | Error queue           | cleared    |
|                   | Memory settings (ARB) | No change  |
|                   | Output                | Off        |
| Interface config. | USB                   | CDC        |
| Calibration       | Calibration Menu      | Restricted |

# PERATION

The Operation chapter shows how to output basic waveforms and create ARB waveforms. The AFG-2105/ 2112/ 2125 can also perform advanced functions such as modulation, sweep, FSK and counter functions.

|  |    |
|--|----|
| Select a Waveform .....  | 36 |
| Sine, Square, Ramp, Noise Waveform .....                           | 36 |
| Setting the Frequency .....  | 36 |
| Setting the Amplitude.....   | 37 |
| Setting the DC Offset .....  | 38 |
| Setting the Duty Cycle/Symmetry.....                               | 39 |
| Setting the Output Impedance .....                                 | 41 |
| Turning the Output On .....  | 42 |
| Amplitude Modulation (AM) (AFG-2100 Series) .....                  | 43 |
| Selecting AM Modulation.....                                       | 43 |
| AM Carrier Waveform .....  | 44 |
| Setting the Carrier Frequency .....                                | 44 |
| Setting the Carrier Amplitude.....                                 | 45 |
| Setting the Modulating Wave Shape .....                            | 46 |
| Setting the Modulation Frequency (Rate) .....                      | 47 |
| Modulation Depth.....  | 48 |
| Setting the Modulation Source.....                                 | 49 |
| Frequency Modulation (FM) (AFG-2100 Series) .....                  | 51 |
| Selecting FM Modulation .....                                      | 51 |
| FM Carrier Waveform .....  | 52 |
| Setting the Carrier Frequency .....                                | 52 |
| Setting the Carrier Amplitude.....                                 | 53 |
| Setting the Modulating Wave Shape.....                             | 54 |
| Setting the Modulation Frequency (Rate) .....                      | 55 |
| Frequency Deviation .....  | 56 |
| Setting the Modulation Source.....                                 | 57 |
| Frequency Shift Keying (FSK) Modulation (AFG-2100 Series)<br>..... | 59 |

|   |    |
|---|----|
| Selecting FSK Modulation.....                 | 59 |
| FSK Carrier Waveform.....                     | 60 |
| FSK Carrier Frequency.....                    | 60 |
| Setting the Carrier Amplitude.....            | 61 |
| Setting the Hop Frequency.....                | 62 |
| FSK Rate.....                                 | 64 |
| Setting the FSK Source.....                   | 65 |
| Frequency Sweep (AFG-2100 Series).....        | 67 |
| Selecting Sweep.....                          | 67 |
| Setting Start and Stop Frequency.....         | 68 |
| Sweep Mode.....                               | 70 |
| Sweep Rate.....                               | 70 |
| Setting the Sweep Source (Trigger).....       | 71 |
| Creating an Arbitrary Waveform.....           | 73 |
| Using the Frequency Counter.....              | 75 |
| Selecting the Frequency Counter Function..... | 75 |
| Selecting the Gate Time.....                  | 75 |
| Using the SYNC Output Port.....               | 77 |
| Connecting the SYNC Output Port.....          | 77 |
| SYNC Output Signal.....                       | 77 |
| Save and Recall State/ARB Waveform.....       | 81 |

## Select a Waveform

The AFG-2000 can output four standard waveforms: sine, square, ramp and noise waveforms.

### Sine, Square, Ramp, Noise Waveform

Panel Operation

1. Press the **FUNC** key repeatedly to select a standard waveform (Sine, Square, Ramp, Noise).



Example:  
Sine wave

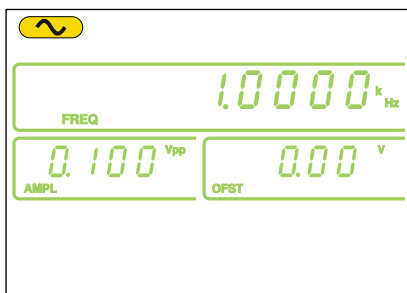

Note

The modulation, FSK, sweep and counter functions must be disabled before a standard waveform can be output.

## Setting the Frequency

Panel Operation

1. Press the **FREQ** key.



2. The FREQ icon will flash in the frequency display area.

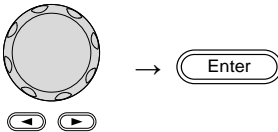

3. Use the **arrow keys, scroll wheel** and **Enter** key to edit the frequency.
- 

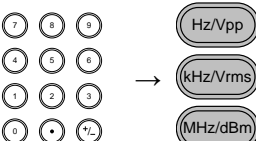
- Use the **keypad** and the relevant **unit** key to enter a new frequency.
- 

|       |        |                |
|-------|--------|----------------|
| Range | Sine   | 0.1Hz ~ 25MHz* |
|       | Square | 0.1Hz ~ 25MHz* |
|       | Ramp   | 0.1Hz ~ 1MHz   |

\*limited to 5MHz for the AFG-2005/2105, 12MHz for the AFG-2012/2112.

Example:  
FREQ = 1kHz

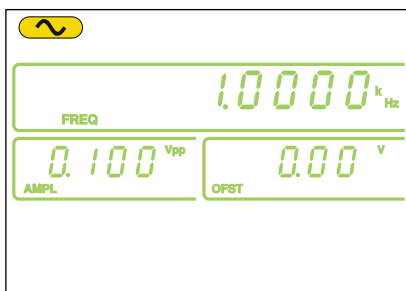

## Setting the Amplitude

- Panel Operation
1. Press the **AMPL** key.
  2. The AMPL icon will flash in the secondary display area.

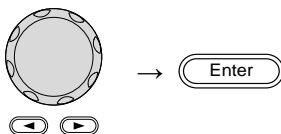

3. Use the **arrow keys, scroll wheel** and **Enter** key to edit the amplitude.
- 

Use the **keypad** and the relevant **unit** key to enter a new amplitude.

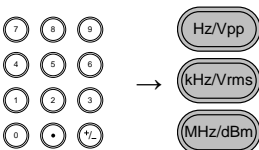

|       |          |  |
|-------|----------|--|
| Range | No load  | 2mVpp~20Vpp<br>2mVpp~10Vpp for 20MHz – 25MHz |
|       | 50Ω Load | 1mVpp~10Vpp<br>1mVpp~5Vpp for 20MHz – 25MHz  |

Example:  
AMPL= 1Vpp

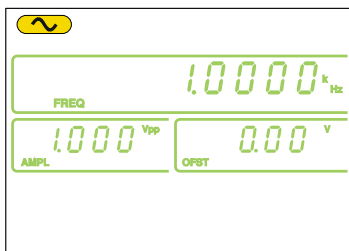

## Setting the DC Offset

Panel Operation 1. Press the **OFST** key.



2. The OFST icon will flash in the secondary display area.





3. Use the **arrow keys, scroll wheel** and **Enter** key to edit the offset.

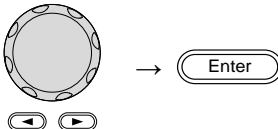

Use the **keypad** and the **Vpp** key to enter a new offset.

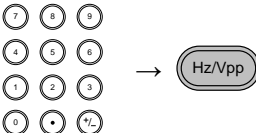

|       |                  |                                    |
|-------|------------------|------------------------------------|
| Range | No Load (AC+DC)  | ±10Vpk<br>±5 Vpk for 20MHz–25MHz   |
|       | 50Ω Load (AC+DC) | ±5 Vpk<br>±2.5 Vpk for 20MHz–25MHz |

Example:  
OFST= 1VDC

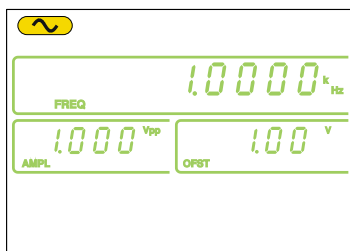

## Setting the Duty Cycle/Symmetry

**Background** The DUTY key sets the duty cycle or symmetry of the standard square or ramp waveforms.

**Panel Operation** 1. Ensure a square or ramp waveform is selected. Page 36

2. Press the **DUTY** key. 

3. The duty icon will flash in the secondary display area.



4. Use the **arrow keys, scroll wheel** and **Enter** key to edit the duty cycle/symmetry.

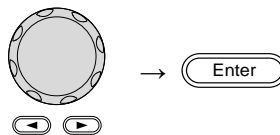

Use the **keypad** and the **%** key to enter a new duty cycle/symmetry.

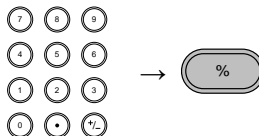

|                  |          |               |
|------------------|----------|---------------|
| Duty Cycle Range | ≤ 100kHz | 1.0% ~ 99.9%  |
|                  | ≤ 5MHz   | 20.0% ~ 80.0% |
|                  | ≤ 10MHz  | 40.0 ~ 60.0%  |
|                  | ≤ 25MHz  | 50.0% (fixed) |

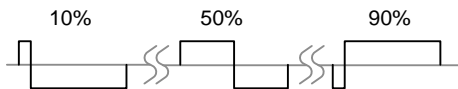

|                |                 |           |
|----------------|-----------------|-----------|
| Symmetry Range | All frequencies | 0% ~ 100% |
|----------------|-----------------|-----------|

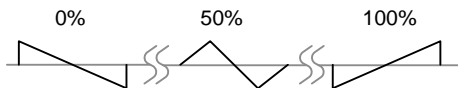

Example:  
DUTY= 50.0%

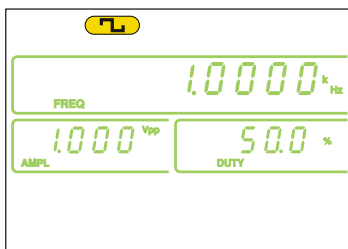

## Setting the Output Impedance

### Background

The AFG-2000 output impedance can be set to 50Ω or to High-Z.

When the output impedance is set to high-Z the effect output is doubled compared to the default 50Ω. For example, when the amplitude is set to 10Vpp (impedance of 50Ω) when the output impedance is switched to high-Z, the amplitude becomes 20Vpp.



Note

dBm units are not supported for the high-Z output impedance.

If the amplitude unit is dBm, and you switch to the High-Z output impedance, the amplitude unit will automatically change to Vpp.

If the output impedance is set to High-Z, you cannot set the amplitude units to dBm. Change the output impedance back to 50Ω first.

### Panel Operation

- To toggle the output impedance between 50 and High-Z, press **SHIFT+OUTPUT**.

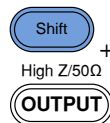

- The selected output impedance will flash momentarily on the display.

50 Ω:



High-Z:



## Turning the Output On

---

Panel Operation

1. Press the **OUTPUT** key to output the selected waveform. 

The output key will turn green when the output is on.

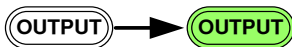

2. To disable the output, press the **OUTPUT** key again. 

The output key will turn off when the output is disabled.



## Amplitude Modulation (AM) (AFG-2100 Series)

An AM waveform is produced from a carrier waveform and a modulating waveform. The amplitude of the modulated carrier waveform depends on the amplitude of the modulating waveform. The AFG-2100 function generator can set the carrier frequency, amplitude and offset as well as internal or external modulation sources.

AM modulation is only applicable for the AFG-2105, AFG-2112 and the AFG-2125 function generators.

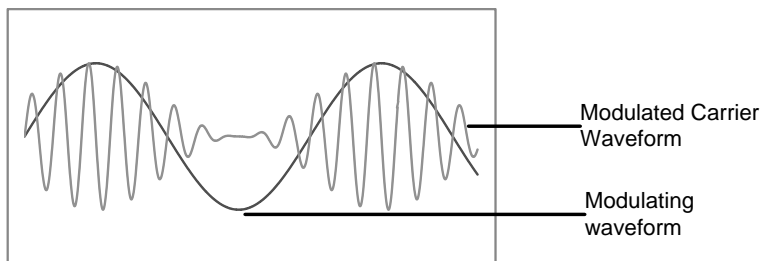

### Selecting AM Modulation

Panel Operation

1. Press the **AM** key.



2. The modulation, sweep and counter menu display will appear. The AM icon indicates that the AM function is active.



Example:  
AM activated

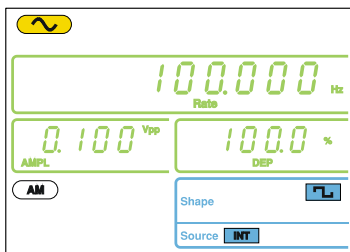

Note

AM modulation can be deactivated by pressing the **AM** key again.

## AM Carrier Waveform

Background

The FUNC key selects the AM carrier waveform. Sine, square or ramp waveforms can be used as the carrier. The default waveform is set to sine. Noise is not available as a carrier shape. Before the carrier shape can be selected, ensure AM is active, page 43.

Selecting the Carrier Shape

1. Press the **FUNC** key repeatedly to select a carrier waveform (Sine, Square, Ramp).



Range

AM Carrier Shape sine, square, ramp

## Setting the Carrier Frequency

Panel Operation

1. Press **FREQ** key.



2. The FREQ icon will flash in the frequency display area.

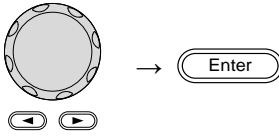

3. Use the **arrow keys, scroll wheel** and **Enter** key to edit the frequency.
- 

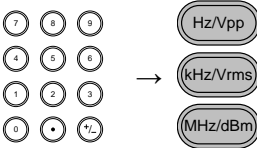
- Use the **keypad** and the relevant **unit** key to enter a new frequency.
- 

|       |        |                |
|-------|--------|----------------|
| Range | Sine   | 0.1Hz ~ 25MHz* |
|       | Square | 0.1Hz ~ 25MHz* |
|       | Ramp   | 0.1Hz ~ 1MHz   |

\*limited to 5MHz for the AFG-2105, 12MHz for the AFG-2112.

Example:  
FREQ = 1kHz

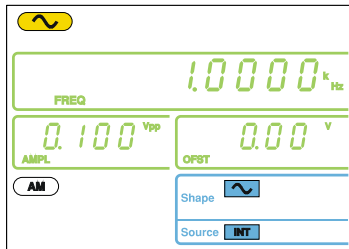

## Setting the Carrier Amplitude

- Panel Operation 1. Press **AMPL** key.
- 

2. The AMPL icon will flash in the secondary display area.

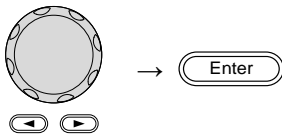

3. Use the **arrow keys, scroll wheel** and **Enter** key to edit the amplitude.
- 

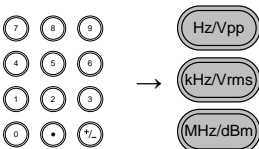
- Use the **keypad** and the relevant **unit** key to enter a new amplitude.
- 

|       |          |  |
|-------|----------|--|
| Range | No Load  | 2mVpp~20Vpp<br>2mVpp~10Vpp for 20MHz – 25MHz |
|       | 50Ω Load | 1mVpp~10Vpp<br>1mVpp~5Vpp for 20MHz – 25MHz  |

Example:  
AMPL= 1Vpp

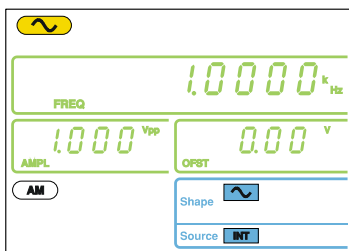

### Setting the Modulating Wave Shape

The AFG-2100 has sine, square and ramp modulating waveform shapes. Sine waves are the default wave shape.

Panel Operation

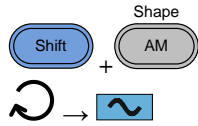
1. Press the **Shift + Shape** key repeatedly to select a shape waveform.
 
2. The waveform Shape is displayed in blue at the bottom of the panel.



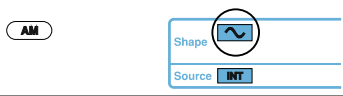

|              |        |                |
|--------------|--------|----------------|
| Restrictions | Square | 50% duty cycle |
|              | Ramp   | 50% symmetry   |

Example:  
Shape = Sine

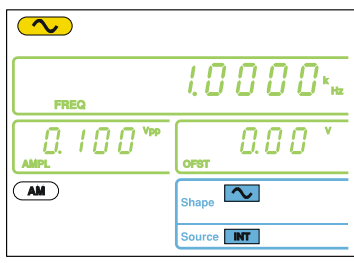

### Setting the Modulation Frequency (Rate)

Panel Operation

1. Press the **Shift + Rate** key.

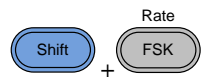

2. The Rate icon will flash in the frequency display area.



3. Use the **arrow keys, scroll wheel** and **Enter** key to edit the rate.

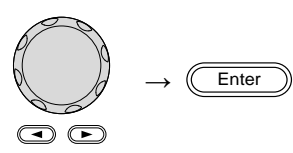

Use the **keypad** and the relevant **unit** key to enter a new rate.

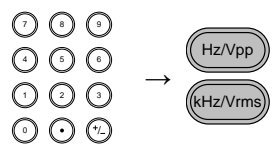

|       |                   |              |
|-------|-------------------|--------------|
| Range | (Internal source) | 2mHz ~ 20kHz |
|       | Default           | 100Hz        |

Example:  
Rate= 100Hz

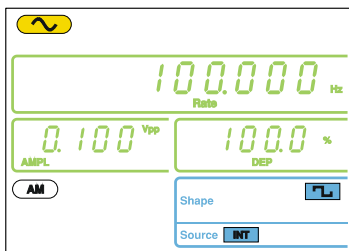

## Modulation Depth

Modulation depth is the ratio (as a percentage) of the unmodulated carrier amplitude and the minimum amplitude deviation of the modulated waveform. In other words, modulation depth is the maximum amplitude of the modulated waveform compared to the carrier waveform as a percentage.

### Panel Operation

1. Press the **Shift + DEP/DEV** key.

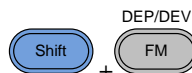

2. The DEP icon will flash in the secondary display area.



3. Use the **arrow keys, scroll wheel** and **Enter** key to edit the modulation depth.

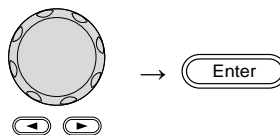

Use the **keypad** and the **%** key to enter a new depth.

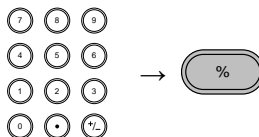

|       |         |           |
|-------|---------|-----------|
| Range | Depth   | 0% ~ 120% |
|       | Default | 100%      |

Example:  
DEP= 100%

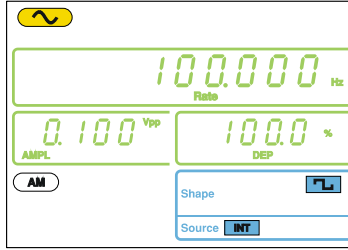

Note

When the modulation depth is greater than 100%, the output cannot exceed  $\pm 5V_{Peak}$  (50 $\Omega$  load).

If an external modulation source is selected, modulation depth is limited to  $\pm 5V$  from the MOD input port on the rear panel. For example, if the modulation depth is set to 100%, then the maximum amplitude is +5V, and the minimum amplitude is -5V.

## Setting the Modulation Source

Panel Operation

1. Press the **Shift + INT/EXT** key to select the modulation source.

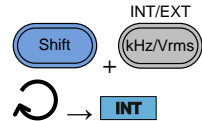

2. The modulation source will be displayed at the bottom of the screen.



Note

If an external modulation source is selected, modulation depth is limited to  $\pm 5V$  from the MOD input port on the rear panel. For example, if the modulation depth is set to 100%, then the maximum amplitude is +5V, and the minimum amplitude is -5V.

Example:  
Source = INT

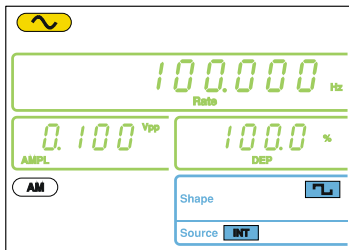

Example: External  
MOD input signal

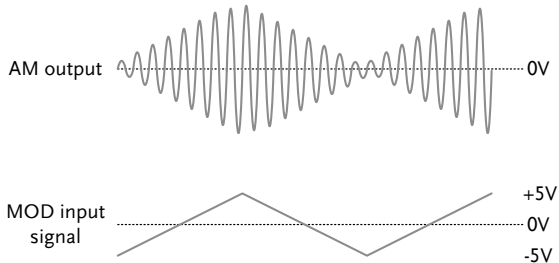

## Frequency Modulation (FM) (AFG-2100 Series)

An FM waveform is produced from a carrier waveform and a modulating waveform. The instantaneous frequency of the carrier waveform varies with the magnitude of the modulating waveform. FM modulation is only applicable to the AFG-2105, AFG-2112 and the AFG-2125.

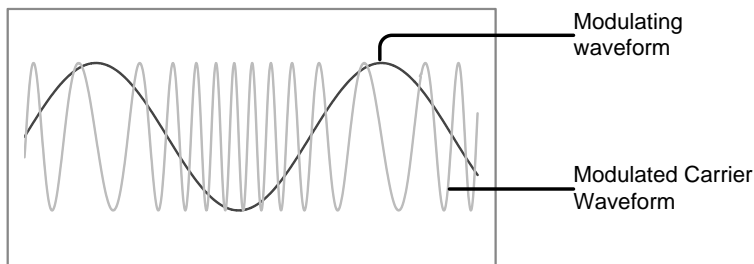

### Selecting FM Modulation

Panel Operation

1. Press the **FM** key.



2. The modulation, sweep and counter menu display will appear. The FM icon indicates that the FM function is active.



Example:  
FM activated

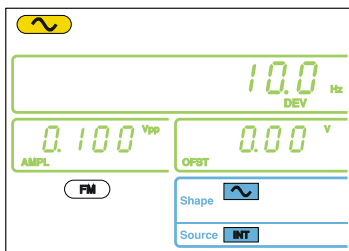

Note

FM modulation can be deactivated by pressing the **FM** key again.

## FM Carrier Waveform

**Background** The FUNC key selects the FM carrier waveform. Sine, square or ramp waveforms can be used as the carrier. The default waveform is set to sine. Noise is not available as a carrier shape. Before the carrier shape can be selected, ensure FM is active, page 51.

Selecting the Carrier Shape

1. Press the **FUNC** key repeatedly to select a carrier waveform (Sine, Square, Ramp).



**Range** FM Carrier Shape sine, square, ramp

## Setting the Carrier Frequency

**Background** When using the AFG-2100 function generator, the carrier frequency must be equal to or greater than the frequency deviation.

Panel Operation

1. Press **FREQ** key.



- The FREQ icon will flash in the frequency display area.



- Use the **arrow keys, scroll wheel** and **Enter** key to edit the frequency.

Use the **keypad** and the relevant **unit** key to enter a new frequency.

|       |        |                |
|-------|--------|----------------|
| Range | Sine   | 0.1Hz ~ 25MHz* |
|       | Square | 0.1Hz ~ 25MHz* |
|       | Ramp   | 0.1Hz ~ 1MHz   |

\*limited to 5MHz for the AFG-2105, 12MHz for the AFG-2112.

Example:  
FREQ = 1kHz

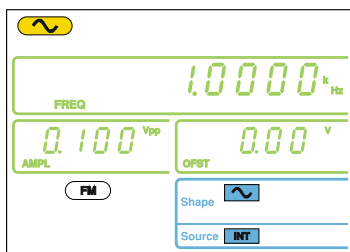

## Setting the Carrier Amplitude

- Panel Operation
- Press **AMPL** key.
  - The AMPL icon will flash in the secondary display area.



- Use the **arrow keys, scroll wheel** and **Enter** key to edit the amplitude.

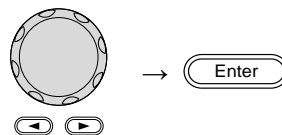

Use the **keypad** and the relevant **unit** key to enter a new amplitude.

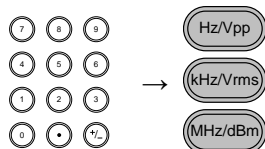

|       |          |  |
|-------|----------|--|
| Range | No Load  | 2mVpp~20Vpp<br>2mVpp~10Vpp for 20MHz – 25MHz |
|       | 50Ω load | 1mVpp~10Vpp<br>1mVpp~5Vpp for 20MHz – 25MHz  |

Example:  
AMPL= 1Vpp

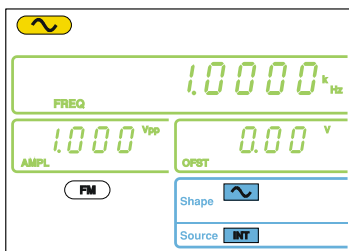

### Setting the Modulating Wave Shape

The AFG-2100 has sine, square and ramp modulating waveform shapes. Sine waves are the default wave shape. The modulating wave shape is for internal sources only.

Panel Operation

- Press the **Shift + Shape** key repeatedly to select a shape waveform.

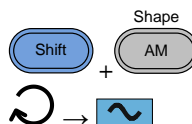



- The waveform Shape is displayed in blue at the bottom of the panel.

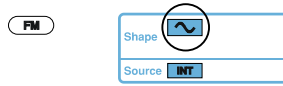

|              |        |                |
|--------------|--------|----------------|
| Restrictions | Square | 50% duty cycle |
|              | Ramp   | 50% symmetry   |

Example:  
Shape = Sine

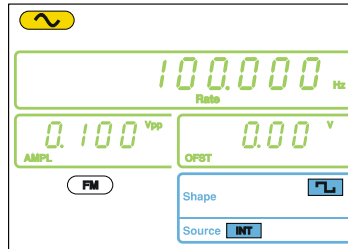

### Setting the Modulation Frequency (Rate)

- Panel Operation
- Press the **Shift + Rate** key.

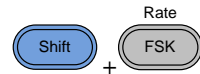

- The Rate icon will flash in the frequency display area.



- Use the **arrow keys, scroll wheel and Enter** key to edit the rate.

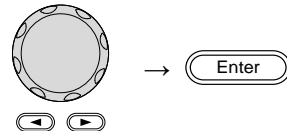

Use the **keypad** and the relevant **unit** key to enter a new rate.

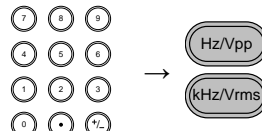

|       |                                |
|-------|--------------------------------|
| Range | (Internal source) 2mHz ~ 20kHz |
|       | Default 100Hz                  |

Example:  
Rate= 100Hz

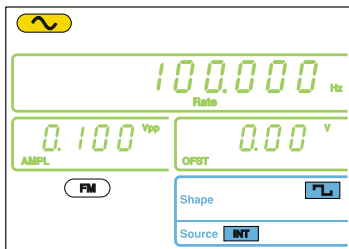

### Frequency Deviation

The frequency deviation is the peak frequency deviation from the carrier wave and the modulated wave.

Panel Operation

1. Press the **Shift + DEP/DEV** key.

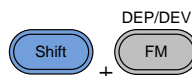

2. The DEV icon will flash in the frequency display area.



3. Use the **arrow keys, scroll wheel** and **Enter** key to edit the frequency deviation.

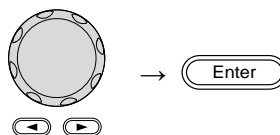

Use the **keypad** and the relevant **unit** key to enter a new frequency deviation.

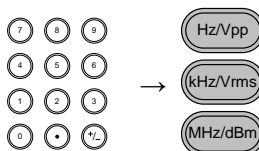

|       |      |             |
|-------|------|-------------|
| Range | Sine | DC ~ 25MHz* |
|-------|------|-------------|

|         |             |
|---------|-------------|
| Square  | DC ~ 25MHz* |
| Ramp    | DC ~ 1MHz   |
| Default | 10Hz        |

\*limited to 5MHz for the AFG-2105, 12MHz for the AFG-2112.



Note

The frequency deviation must be equal to or less than the carrier frequency.

The sum of the carrier frequency and frequency deviation must be less than or equal to the maximum carrier.

The maximum frequency deviation allowed will be limited by the set carrier frequency.

Example:  
DEV = 10Hz

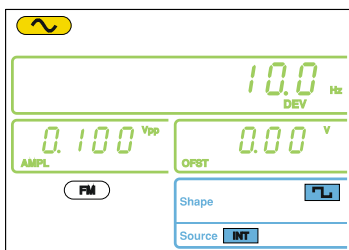

## Setting the Modulation Source

Panel Operation

1. Press the **Shift + INT/EXT** key to select the modulation source.

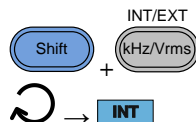

2. The modulation source will be displayed at the bottom of the screen.

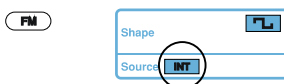

| Range | Source | INT, EXT |
|-------|--------|----------|
|-------|--------|----------|

Connection  
(EXT source only)

For external sources, connect the modulation source signal to the MOD input port on the rear panel.

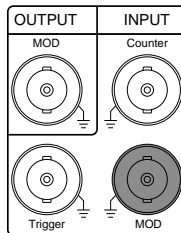

Note

When the source is set to EXT (external) the carrier waveform is modulated by an external signal. The frequency deviation is controlled by the  $\pm 5V$  signal that is input into the MOD input port. The  $\pm 5V$  input signal directly corresponds to the set frequency deviation. +5V increases the frequency by the set deviation frequency and -5V reduces the frequency to below the carrier frequency by the amount set by the deviation frequency. For example: if the deviation frequency is set to 1kHz, an input voltage of +5V will increase the frequency to 1kHz, whilst an input voltage of -5V will reduce the frequency below that of the carrier by 1kHz.

Example:  
Source = INT

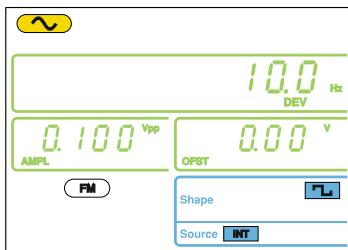

Example: External  
MOD input signal

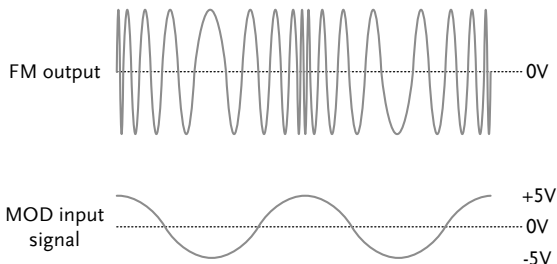

## Frequency Shift Keying (FSK) Modulation (AFG-2100 Series)

Frequency Shift Keying Modulation is used to shift the frequency output of the function generator between two preset frequencies (carrier frequency, hop frequency). The frequency at which the carrier and hop frequency shift is determined by the rate setting or the voltage level from the Trigger input port on the rear panel.

FSK modulation is only applicable to the AFG-2105, AFG-2112 and the AFG-2125.

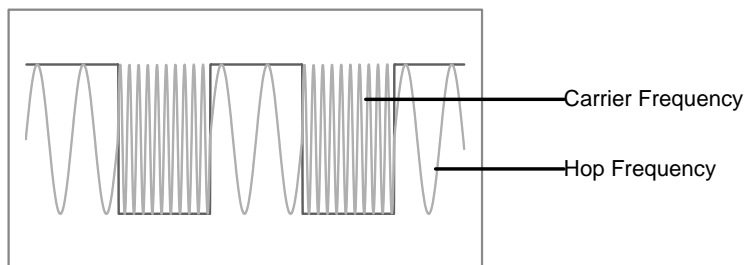

### Selecting FSK Modulation

Panel Operation

1. Press the **FSK** key.



2. The modulation, sweep and counter menu display will appear. The FSK icon indicates that the FSK function is active.



Example:  
FSK activated

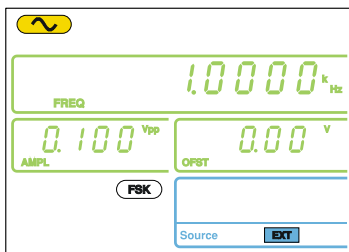

**Note** FSK modulation can be deactivated by pressing the **FSK** key again.

## FSK Carrier Waveform

**Background** The FUNC key selects the FSK carrier waveform. Sine, square or ramp waveforms can be used as the carrier. The default waveform is set to sine. Noise and ARB cannot be used as a carrier wave.

**Selecting the Carrier**

1. Press the **FUNC** key repeatedly to select a carrier waveform (Sine, Square, Ramp).



**Range** FSK Carrier Shape sine, square, ramp

## FSK Carrier Frequency

The maximum carrier frequency depends on the carrier shape. The default carrier frequency for all carrier shapes is 1kHz. The voltage level of the Trigger input port controls the output frequency when EXT is selected as the source. When the Trigger input signal is logically low, the carrier frequency is output and when the signal is logically high, the hop frequency is output.

**Panel Operation**

1. Press **FREQ** key.



- The FREQ icon will flash in the frequency display area.



- Use the **arrow keys, scroll wheel** and **Enter** key to edit the frequency.

Use the **keypad** and the relevant **unit** key to enter a new frequency.

|       |        |                |
|-------|--------|----------------|
| Range | Sine   | 0.1Hz ~ 25MHz* |
|       | Square | 0.1Hz ~ 25MHz* |
|       | Ramp   | 0.1Hz ~ 1MHz   |

\*limited to 5MHz for the AFG-2105, 12MHz for the AFG-2112.

Example:  
FREQ = 1kHz

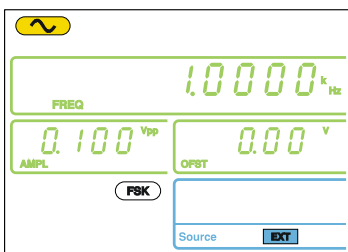

## Setting the Carrier Amplitude

- Panel Operation
- Press **AMPL** key.

- The AMPL icon will flash in the secondary display area.



- Use the **arrow keys, scroll wheel** and **Enter** key to edit the amplitude.

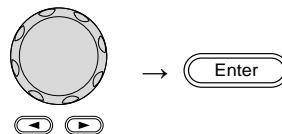

Use the **keypad** and the relevant **unit** key to enter a new amplitude.

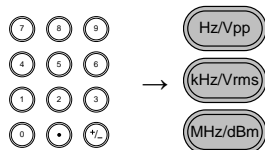

|       |          |  |
|-------|----------|--|
| Range | No Load  | 2mVpp~20Vpp<br>2mVpp~10Vpp for 20MHz – 25MHz |
|       | 50Ω Load | 1mVpp~10Vpp<br>1mVpp~5Vpp for 20MHz – 25MHz  |

Example:  
AMPL= 1Vpp

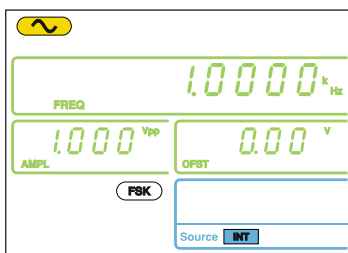

### Setting the Hop Frequency

The default Hop frequency for all waveform shapes is 100 Hz. A square wave with a duty cycle of 50% is used for the internal modulation waveform. The voltage level of the Trigger input signal controls the output frequency when EXT is selected. When the Trigger input signal is logically low the carrier frequency is output and when the signal is logically high, the hop frequency is output.



Panel Operation

1. Press the **Shift + Hop** key.

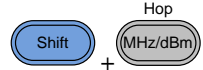

2. The Hop icon will flash in the frequency display area.

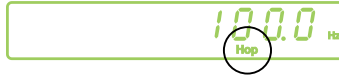

3. Use the **arrow keys, scroll wheel and Enter** key to edit the hop frequency.

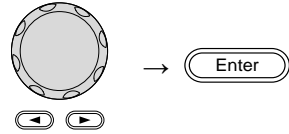

Use the **keypad** and the relevant **unit** key to enter a hop frequency.

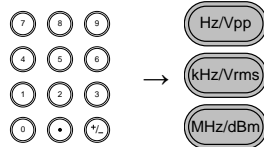

|       |         |                |
|-------|---------|----------------|
| Range | Sine    | 0.1Hz ~ 25MHz* |
|       | Square  | 0.1Hz~ 25MHz*  |
|       | Ramp    | 0.1Hz~ 1MHz    |
|       | Default | 100Hz          |

\*limited to 5MHz for the AFG-2105, 12MHz for the AFG-2112.

Example:  
Hop = 100Hz

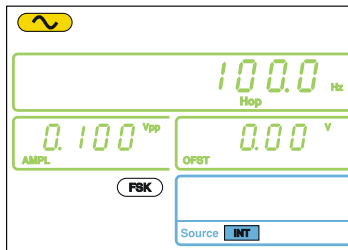

## FSK Rate

FSK Rate function is used to determine the rate at which the output frequency changes between the carrier and hop frequencies. The FSK Rate function only applies to internal FSK sources.

### Panel Operation

1. Press the **Shift + Rate** key.

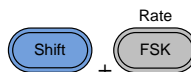

2. The Rate icon will flash in the frequency display area.



3. Use the **arrow keys, scroll wheel** and **Enter** key to edit the rate.

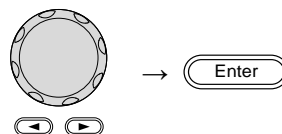

Use the **keypad** and the relevant **unit** key to enter a new rate.

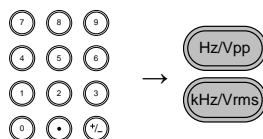

### Range

(Internal source) 2mHz ~ 20kHz

Default

100Hz

Example:

Rate= 1KHz

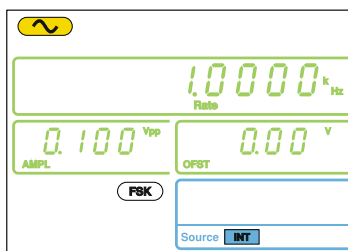

## Setting the FSK Source

The AFG-2000 accepts internal and external FSK sources, with internal as the default source. When the FSK source is set to internal, the FSK rate is configured using the FSK Rate function. When an external source is selected the FSK rate is equal to the frequency of the Trigger input signal on the rear panel. When the input signal is logically low the carrier frequency is output and when the signal is logically high, the hop frequency is output.

**Panel Operation**

1. Press the **Shift + INT/EXT** key to select the modulation source.

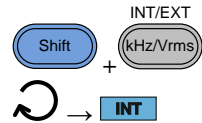

2. The FSK source will be displayed at the bottom of the screen.

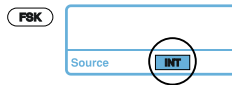

**Range**

Source

INT, EXT

**Connection  
(EXT source only)**

For external sources, connect the FSK rate source signal to the Trigger input port on the rear panel.

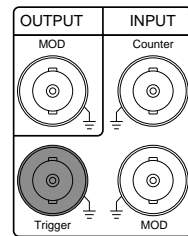

**Example:  
Source = EXT**

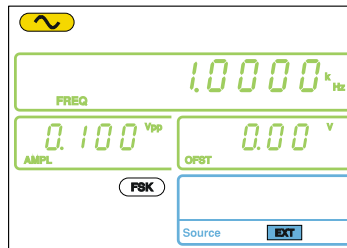

Example: External  
trigger input  
signal

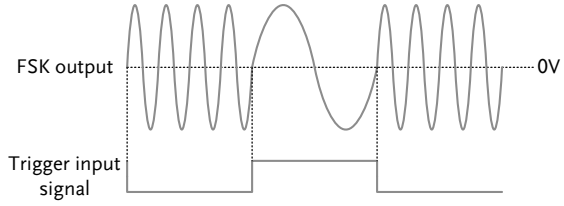

## Frequency Sweep (AFG-2100 Series)

The function generator can perform a sweep for sine, square or ramp waveforms, but not noise, and ARB. In Sweep mode, the function generator will sweep from a start frequency to a stop frequency over a number of designated steps. If an external source is selected, the function generator can be used to output a single sweep each time a TTL level pulse is received from the Trigger input port. The step spacing of the sweep can be linear or logarithmic. The function generator can also sweep up or sweep down in frequency. The Sweep function only applies to the AFG-2105, AFG-2112 and the AFG-2125.

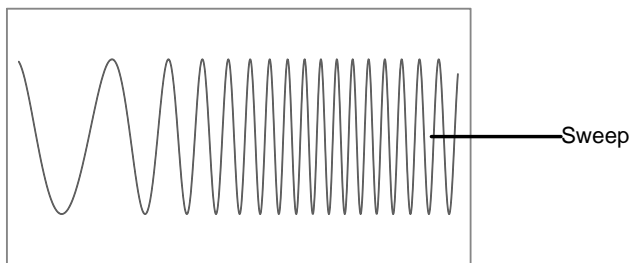

### Selecting Sweep

Panel Operation

1. Press the **Sweep** key.



2. The modulation, sweep and counter menu display will appear. The Sweep icon indicates that the Sweep function is active.

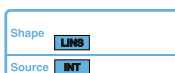

Example:  
Sweep activated

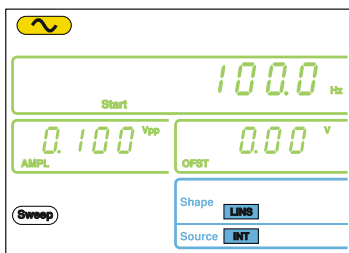

Note

Sweep modulation can be deactivated by pressing the **Sweep** key again.

### Setting Start and Stop Frequency

The start and stop frequencies define the upper and lower sweep limits. The function generator will sweep from the start through to the stop frequency and cycle back to the start frequency. The sweep is phase continuous over the full sweep range.

Panel Operation

1. Pressing the **Shift +**

**Start/Stop** key will toggle between the start and stop frequencies. Select the **Start**

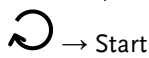
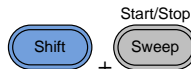

2. The Start icon will flash in the frequency display area when selected.

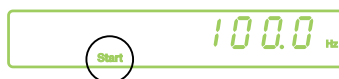

3. Use the **arrow keys, scroll wheel** and **Enter** key to edit the start frequency.



Use the **keypad** and the relevant **unit** key to enter a new start frequency.

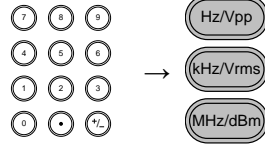

|       |         |                          |
|-------|---------|--------------------------|
| Range | Sine    | 0.1Hz ~ 25MHz*           |
|       | Square  | 0.1Hz ~ 25MHz*           |
|       | Ramp    | 0.1Hz ~ 1MHz             |
|       | Default | Start: 100Hz, Stop: 1kHz |

\*limited to 5MHz for the AFG-2105, 12MHz for the AFG-2112.

4. Repeat steps 1 to 3 for the Stop frequency.



Note

To sweep from a low to high frequency, set the Start frequency < Stop frequency.

To sweep from a high to low frequency, set the Start frequency > Stop frequency.

Example:  
Start = 100Hz

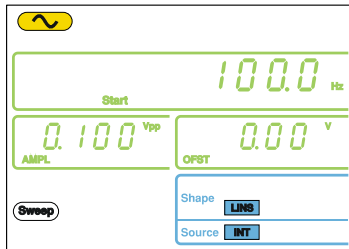

Example:  
Stop = 1kHz

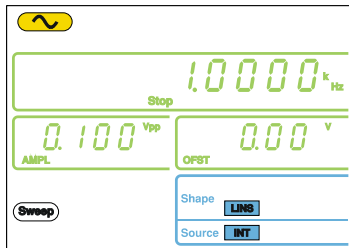

## Sweep Mode

Sweep mode is used to select between linear or logarithmic sweeping. Linear sweeping is the default setting.

### Panel Operation

1. Press the **Shift + LIN/LOG** key to select linear (LINS) or logarithmic (LOGS) sweeps.

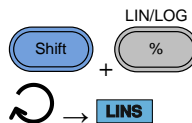

2. The LINS or LOGS icon will be displayed at the bottom of the screen.



Example:

Sweep = LINS

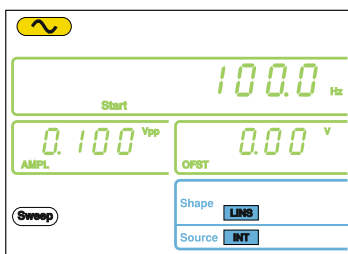

## Sweep Rate

The sweep rate is used to determine how long it takes to perform a sweep from the start to stop frequencies. The function generator automatically determines the number of discrete frequencies used in the scan depending on the length of the scan.

### Panel Operation

1. Press the **Shift + Rate** key.

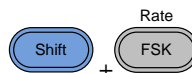

2. The Rate icon will flash in the frequency display area.





3. Use the **arrow keys, scroll wheel** and **Enter** key to edit the rate.

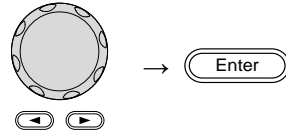

Use the **keypad** and the relevant **unit** key to enter a new rate.

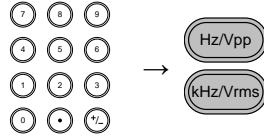

|       |            |                          |
|-------|------------|--------------------------|
| Range | Sweep Rate | 1kHz ~ 2mHz (1ms ~ 500s) |
|       | Default    | 100Hz                    |

Example:  
Rate= 100Hz

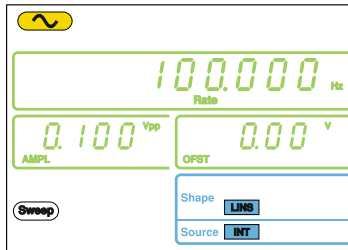

### Setting the Sweep Source (Trigger)

With the source set to EXT, the function generator will sweep each time a trigger signal is received. After a sweep output has completed, the function generator waits for a trigger signal before starting the next sweep. The default trigger source is internal.

- Panel Operation 1. Press the **Shift + INT/EXT** key to select the modulation source.

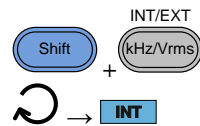

- The Trigger source will be displayed at the bottom of the screen.



|       |        |          |
|-------|--------|----------|
| Range | Source | INT, EXT |
|-------|--------|----------|

Connection  
(EXT source only)

For external sources, connect the Sweep trigger signal to the Trigger input port on the rear panel.

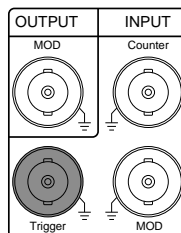

Example:  
Source = EXT

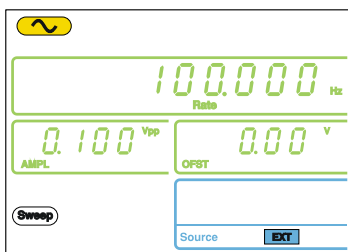

Note

With an external source, a sweep is output each time a trigger pulse (TTL) is received from the Trigger input port on the rear panel.

The trigger frequency must be greater than the sweep rate (sweep time) plus 125nS (trigger pulse width > 125nS).

Example: External trigger input signal

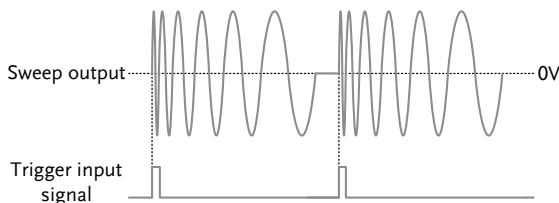

## Creating an Arbitrary Waveform

Both the AFG-2000 and AFG-2100 has a simple arbitrary waveform editing function. The ARB function is able to create waveforms with a 20MHz sampling rate, 4k data points with vertical range of  $\pm 511$ points.

Selecting the Carrier Shape

1. Press the **FUNC** key repeatedly to select the ARB function.



2. Press the **Point** key.



3. Point will flash in the secondary display area.



4. Use the **scroll wheel** or **keypad** to choose a point number.

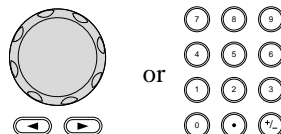

Use the **Enter** key to confirm the point number.

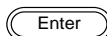

Range

Point: 0 ~ 4096

5. Press the **Value** key.

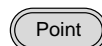

6. Value will flash in the secondary display area.



7. Use the **scroll wheel** or **keypad** to choose the vertical value of the selected point.

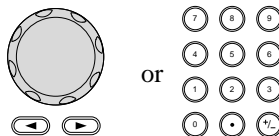

Use the **Enter** key to confirm the point value.

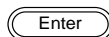

Range

Value:  $\pm 511$  (10-bit vertical resolution)

8. Repeat steps 2 to 7 for the remaining points of the ARB waveform.



Note

The horizontal position of the points depends on the set frequency. For example, if the set frequency is 1kHz (period = 1ms), then each point will be located every 0.01ms (1ms/sample rate).

Example:  
Point "0" is set to +511.

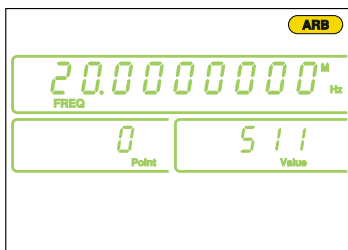

Note

To save the ARB data, please see the Save/Recall section on page 81.

# Using the Frequency Counter

## Selecting the Frequency Counter Function

**Connection**      Connect the signal source to Counter input port on the rear panel.

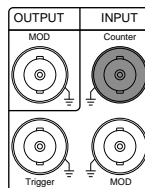

**Panel Operation**      1. Press the **Count** key.



2. The current gate time and the Count icon will appear in the display when the counter function is active.  
The input frequency will be shown in the frequency display area.

Example: input frequency of 1kHz

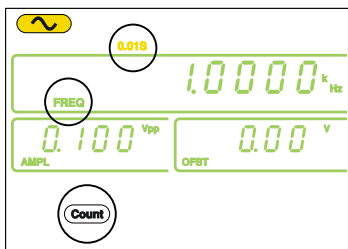

## Selecting the Gate Time

**Panel Operation**      1. Ensure the Count function is active.

2. Press the **Shift + Gate** key repeatedly to select the desired gate time.

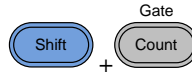

|       |           |                      |
|-------|-----------|----------------------|
| Range | Gate time | 0.01s, 0.1s, 1s, 10s |
|-------|-----------|----------------------|

3. The current gate time is displayed in the counter settings area of the display.



## Using the SYNC Output Port

### Connecting the SYNC Output Port

**Background**      The SYNC output port is used as a synchronization signal for function outputs. All the output signals apart from the noise output function have a synchronization signal.

**Connection**      Connect a BNC cable from the SYNC output port on the front panel to the desired input device.

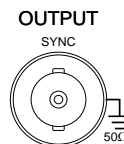

 **Note**

The SYNC signal is output even when the main output is not output.

### SYNC Output Signal

**SYNC Output For Sine Wave**      SYNC output: TTL square waveform with a 50% duty cycle. The SYNC output is at a logically high level when the sine output is positive.

**Output diagram**

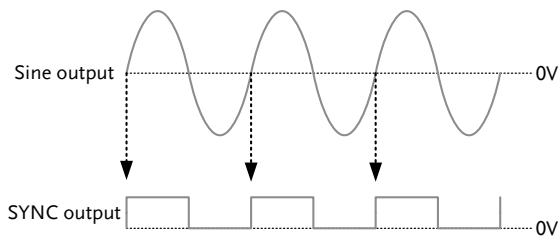

**SYNC Output For Square Wave** SYNC output: TTL square waveform with a duty cycle corresponding to the duty cycle of the output square wave. The SYNC output is at a logically high level when the square wave output is positive.

Output diagram

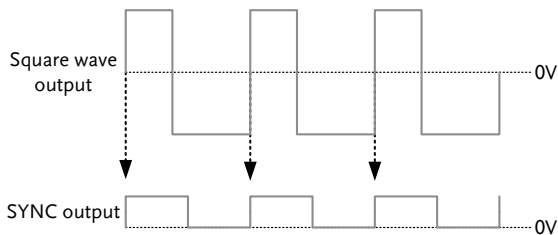

**SYNC Output For Ramp Wave** SYNC output: TTL square waveform with a 50% duty cycle. The SYNC output is at a logically high level when the sine output is positive.

Output diagram

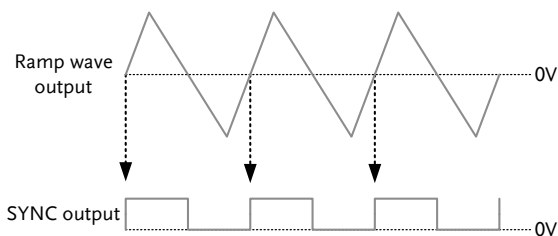

**SYNC Output For ARB Wave** SYNC output: A single TTL positive pulse at the start of each ARB period (pulse width = 1/sample rate).

Output diagram

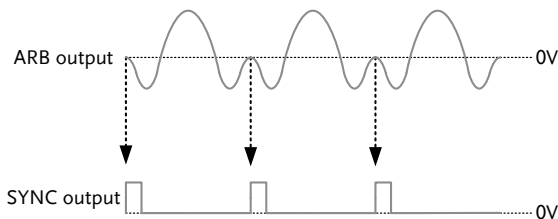



SYNC Output For AM SYNC output: TTL square waveform with a 50% duty cycle. The SYNC output is at a logically high level when the modulated output is positive.

Output diagram

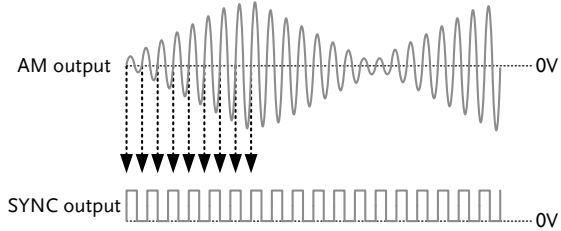

SYNC Output For FM SYNC output: TTL square waveform with a 50% duty cycle. The SYNC output is at a logically high level when the modulated output is positive (The SYNC output is synchronized to the modulated output frequency).

Output diagram

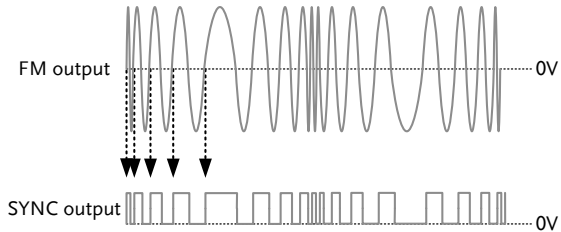

SYNC Output For FSK SYNC output: TTL square waveform with a 50% duty cycle. The SYNC output is at a logically high level when the modulated output is positive (The SYNC output is synchronized to the modulated output frequency).

Output diagram

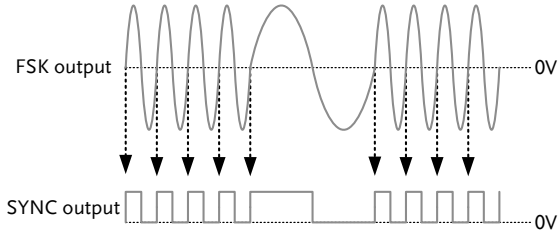

SYNC Output For Sweep SYNC output: TTL square waveform. The SYNC output is at a logically high level when the sweep output is positive (The SYNC output is synchronized to the sweep output frequency).

Output diagram

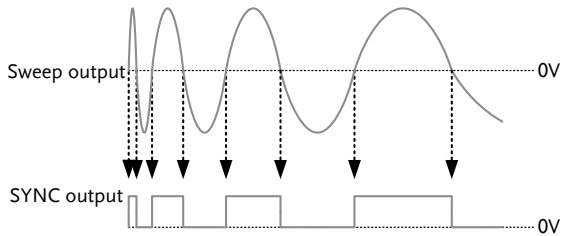

## Save and Recall State/ARB Waveform

The AFG-2000 has non-volatile memory to store instrument state and ARB data. There are 10 memory locations numbered 0~19. Memory locations 0~9 saves/recalls the instrument state, memory locations 10~19 saves/recalls ARB data.

The instrument saves the following states: the selected function (including ARB), frequency, amplitude, DC offset, duty cycle/symmetry, and any of the modulation parameters.

Panel Operation

1. Press the **Shift + Save/Recall** key to either select **Save** (to save the state) or **Recall** (to recall the state).

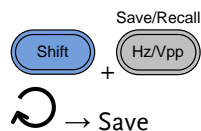

2. Save or Recall will be shown in the secondary display area.



3. Use the **scroll wheel** or **keypad** to choose the save/recall number.

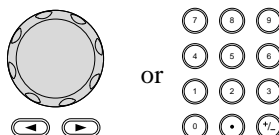

Use the **Enter** key to save/recall the state.

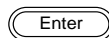

**Note**

The instrument state can be saved to any 10 (0~9) of the storage locations. ARB data can be saved to any 10 (10~19) instrument locations.

When a state is saved, it overwrites the previously saved state in the same location. If ARB data is recalled, the current state will be overwritten.

A memory location can only be recalled if it has been previously saved.

Example:  
Save State



Example:  
Recall State



# REMOTE INTERFACE

|  |     |
|--|-----|
| Selecting the USB Remote Interface ..... | 85  |
| Remote control terminal connection ..... | 85  |
| Command Syntax .....                     | 86  |
| Command List .....                       | 92  |
| System Commands .....                    | 94  |
| *IDN? .....                              | 94  |
| *RST .....                               | 94  |
| Status Register Commands .....           | 95  |
| *CLS .....                               | 95  |
| Apply Commands .....                     | 96  |
| SOURce[1]:APPLy:SiNusoid .....           | 98  |
| SOURce[1]:APPLy:SQUare .....             | 98  |
| SOURce[1]:APPLy:RAMP .....               | 99  |
| SOURce[1]:APPLy:NOISe .....              | 99  |
| SOURce[1]:APPLy:USER .....               | 100 |
| SOURce[1]:APPLy? .....                   | 100 |
| Output Commands .....                    | 102 |
| SOURce[1]:FUNCTion .....                 | 102 |
| SOURce[1]:FREQUency .....                | 103 |
| SOURce[1]:AMPLitude .....                | 105 |
| SOURce[1]:DCOffset .....                 | 106 |
| SOURce[1]:SQUare:DCYCLE .....            | 106 |
| SOURce[1]:RAMP:SYMMetry .....            | 107 |
| OUTPut .....                             | 108 |
| SOURce[1]:VOLTag:e:UNIT .....            | 109 |
| Amplitude Modulation (AM) Commands ..... | 110 |
| AM Overview .....                        | 110 |
| SOURce[1]:AM:STATe .....                 | 111 |
| SOURce[1]:AM:SOURce .....                | 111 |
| SOURce[1]:AM:INTernal:FUNCTion .....     | 112 |
| SOURce[1]:AM:INTernal:FREQUency .....    | 112 |
| SOURce[1]:AM:DEPTH .....                 | 113 |
| Frequency Modulation (FM) Commands ..... | 114 |

|   |     |
|---|-----|
| FM Overview .....                           | 114 |
| SOURce[1]:FM:STATe .....                    | 114 |
| SOURce[1]:FM:SOURce .....                   | 115 |
| SOURce[1]:FM:INTernal:FUNcTion .....        | 116 |
| SOURce[1]:FM:INTernal:FREQuency .....       | 116 |
| SOURce[1]:FM:DEVIation .....                | 117 |
| Frequency-Shift Keying (FSK) Commands ..... | 119 |
| FSK Overview .....                          | 119 |
| SOURce[1]:FSKey:STATe.....                  | 119 |
| SOURce[1]:FSKey:SOURce .....                | 120 |
| SOURce[1]:FSKey:FREQuency .....             | 120 |
| SOURce[1]:FSKey:INTernal:RATE.....          | 121 |
| Frequency Sweep Commands.....               | 123 |
| Sweep Overview .....                        | 123 |
| SOURce[1]:SWEp:STATe.....                   | 124 |
| SOURce[1]:FREQuency:STARt .....             | 124 |
| SOURce[1]:FREQuency:STOP.....               | 125 |
| SOURce[1]:SWEp:SPACing .....                | 126 |
| SOURce[1]:SWEp:RATE .....                   | 126 |
| SOURce[1]:SWEp:SOURce.....                  | 127 |
| Frequency Counter Commands .....            | 128 |
| COUNter:GATe .....                          | 128 |
| COUNter:STATe.....                          | 128 |
| COUNter:VALue? .....                        | 129 |
| Arbitrary Waveform Commands .....           | 130 |
| Arbitrary Waveform Overview.....            | 130 |
| SOURce[1]:FUNcTion USER.....                | 131 |
| DATA:DAC.....                               | 131 |
| Save and Recall Commands .....              | 133 |
| *SAV .....                                  | 133 |
| *RCL .....                                  | 133 |

## Selecting the USB Remote Interface

The AFG-2000 uses a USB interface for remote control. Connecting to USB

|                   |                         |                      |
|-------------------|-------------------------|----------------------|
| USB configuration | PC side connector       | Type A, host         |
|                   | AFG-2000 side connector | Type B, slave        |
|                   | Speed                   | 1.1/2.0 (full speed) |

### Panel Operation

1. Connect the Type B USB—USB-A cable from the PC to the type B USB port on the rear panel. 
2. When the PC asks for the USB driver, select XXXXXX.inf included in the software package or download the driver from the GW website, [www.gwinstek.com](http://www.gwinstek.com).
3. The USB icon will appear when the USB connection is active.



## Remote control terminal connection

### Terminal application

Invoke the terminal application such as Hyper Terminal. Make note of the COM port, baud rate, stop bit, data bit, and parity accordingly from the Windows Device Manager.

To check the COM port settings, see the Device Manager in the PC. For WinXP, Control panel → System → Hardware tab.

---

|                     |   |
|---------------------|---|
| Functionality check | Run this query command via the terminal.<br>*idn?<br><br>This should return the Manufacturer, Model number, Serial number, and Firmware version in the following format.<br><br>GW INSTEK, AFG-2125, SN:XXXXXXXX, Vm.mm |
|---------------------|---|

---



Note

^j and ^m can be used as the terminal character when using a terminal program.

---

|             |   |
|-------------|---|
| PC Software | The proprietary PC software, downloadable from GWInstek website, can be used to download waveforms. |
|-------------|---|

---

## Command Syntax

---

|                     |  |
|---------------------|--|
| Compatible standard | <ul style="list-style-type: none"><li>• IEEE488.2, 1992 (fully compatible)</li><li>• SCPI, 1994 (partially compatible)</li></ul> |
|---------------------|--|

---

|              |  |
|--------------|--|
| Command Tree | The SCPI standard is an ASCII based standard that defines the command syntax and structure for programmable instruments. |
|--------------|--|

Commands are based on a hierarchical tree structure. Each command keyword is a node on the command tree with the first keyword as the root node. Each sub node is separated with a colon.

Shown below is a section of the SOURce[1] root node and the APPLy/OUTPut and SINusoid/SQUare sub nodes.



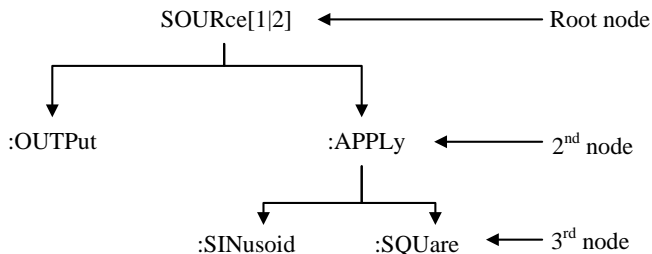

|               |   |
|---------------|---|
| Command types | Commands can be separated into three distinct types, simple commands, compound commands and queries.  |
| Simple        | A single command with/without a parameter   |
| Example       | *OPC  |
| Compound      | Two or more commands separated by a colon (:) with/without a parameter  |
| Example       | SOURCE:APPLY:SQUare   |
| Query         | A query is a simple or compound command followed by a question mark (?). A parameter (data) is returned. The maximum or minimum value for a parameter can also be queried where applicable. |
| Example       | SOURCE1:FREQUENCY?<br>SOURCE1:FREQUENCY? MIN  |

Command forms    Commands and queries have two different forms, long and short. The command syntax is written with the short form of the command in capitals and the remainder (long form) in lower case.

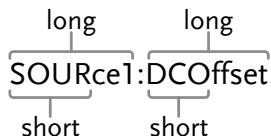

The commands can be written in capitals or lower-case, just so long as the short or long forms are complete. An incomplete command will not be recognized.

Below are examples of correctly written commands:

LONG:    SOURCE1:DCOFFSET  
          SOURCE1:DCOFFSET  
          source1:dcoffset

SHORT:    SOUR1:DCO  
          sour1:dco

|                |  |   |
|----------------|--|---|
| Command Format | <u>SOURCE1:DCOFFSET</u> < offset > LF <div style="display: flex; justify-content: space-around; width: 100%; margin-top: -10px;"> <span style="margin-left: 100px;">1</span> <span>2</span> <span>3</span> <span>4</span> </div> | 1: command header<br>2: single space<br>3: parameter<br>4: message terminator |
|----------------|--|---|

Square Brackets [ ]    Commands that contain squares brackets indicate that the contents are optional. The function of the command is the same with or without the square bracketed items. Brackets are not sent with the command.

For example, the frequency query below can use any of the following 3 forms:

SOURCE1:FREQUENCY? [MINimum|MAXimum]  
 SOURCE1:FREQUENCY? MAXimum

|                     |   |  |                                 |
|---------------------|---|--|---------------------------------|
|                     | SOURce1:FREQUENCY? MINimum  |  |                                 |
|                     | SOURce1:FREQUENCY?  |  |                                 |
| Braces { }          | Commands that contain braces indicate one item within the braces must be chosen. Braces are not sent with the command.  |  |                                 |
| Angled Brackets < > | Angle brackets are used to indicate that a value must be specified for the parameter. See the parameter description below for details. Angled brackets are not sent with the command. |  |                                 |
| Bars                | Bars are used to separate multiple parameter choices in the command format.   |  |                                 |
| Parameters          | Type  | Description  | Example                         |
|                     | <Boolean>   | Boolean logic  | 0, 1/ON,OFF                     |
|                     | <NR1>   | integers   | 0, 1, 2, 3                      |
|                     | <NR2>   | decimal numbers  | 0.1, 3.14, 8.5                  |
|                     | <NR3>   | floating point   | 4.5e-1, 8.25e+1                 |
|                     | <NRf>   | any of NR1, 2, 3   | 1, 1.5, 4.5e-1                  |
|                     | <NRf+><br><Numeric>   | NRf type with a suffix including MINimum, MAXimum or DEFault parameters. | 1, 1.5, 4.5e-1<br>MAX, MIN, DEF |
|                     | <aard>  | Arbitrary ASCII characters.  |                                 |
|                     | <discrete>  | Discrete ASCII character parameters                                      | IMM, EXT, MAN                   |
|                     | <frequency><br><peak deviation in Hz><br><rate in Hz>   | NRf+ type including frequency unit suffixes.                             | 1 KHZ, 1.0 HZ, MHZ              |

|                     |  |  |                |
|---------------------|--|--|----------------|
|                     | <amplitude>  | NRf+ type including voltage unit suffixes.   | VPP, dBm, Vrms |
|                     | <offset>   | NRf+ type including voltage unit suffixes.   | V              |
|                     | <seconds>  | NRf+ type including time unit suffixes.  | nS, uS, mS, S  |
|                     | <percent><br><depth in percent>  | NRf type   | N/A            |
| Message terminators | LF CR  | line feed code (new line) and carriage return.   |                |
|                     | LF   | line feed code (new line)  |                |
| Command Separators  |  Note<br>$\Lambda$ j or $\Lambda$ m should be used when using a terminal program. |  |                |
|                     | Space  | A space is used to separate a parameter from a keyword/command header.                                 |                |
|                     | Colon (:)  | A colon is used to separate keywords on each node.   |                |
|                     | Semicolon (;)  | A semicolon can be used to combine commands from different node levels.                                |                |
|                     |  | For example:<br>SOURce1:PWM:SOURce?<br>SOURce:PULSe:WIDTh?<br>→SOURce1:PWM:SOURce?;SOURce:PULSe:WIDTh? |                |

Comma (,)      When a command uses multiple parameters, a comma is used to separate the parameters.

For example:

SOURce:APPLy:SQUare 10KHZ,2.0  
VPP,-1VDC

---

# Command List

|   |     |
|---|-----|
| System Commands .....                       | 94  |
| *IDN? .....                                 | 94  |
| *RST .....                                  | 94  |
| Status Register Commands .....              | 95  |
| *CLS .....                                  | 95  |
| Apply Commands .....                        | 96  |
| SOURce[1]:APPLY:SINusoid .....              | 98  |
| SOURce[1]:APPLY:SQUare .....                | 98  |
| SOURce[1]:APPLY:RAMP .....                  | 99  |
| SOURce[1]:APPLY:NOISe.....                  | 99  |
| SOURce[1]:APPLY:USER .....                  | 100 |
| SOURce[1]:APPLY? .....                      | 100 |
| Output Commands .....                       | 102 |
| SOURce[1]:FUNCTion .....                    | 102 |
| SOURce[1]:FREQUency .....                   | 103 |
| SOURce[1]:AMPLitude.....                    | 105 |
| SOURce[1]:DCOffset.....                     | 106 |
| SOURce[1]:SQUare:DCYClE.....                | 106 |
| SOURce[1]:RAMP:SYMMetry .....               | 107 |
| OUTPut .....                                | 108 |
| SOURce[1]:VOLTage:UNIT.....                 | 109 |
| Amplitude Modulation (AM) Commands .....    | 110 |
| AM Overview.....                            | 110 |
| SOURce[1]:AM:STATe.....                     | 111 |
| SOURce[1]:AM:SOURce .....                   | 111 |
| SOURce[1]:AM:INTernal:FUNCTion .....        | 112 |
| SOURce[1]:AM:INTernal:FREQUency.....        | 112 |
| SOURce[1]:AM:DEPTH.....                     | 113 |
| Frequency Modulation (FM) Commands.....     | 114 |
| FM Overview .....                           | 114 |
| SOURce[1]:FM:STATe.....                     | 114 |
| SOURce[1]:FM:SOURce.....                    | 115 |
| SOURce[1]:FM:INTernal:FUNCTion .....        | 116 |
| SOURce[1]:FM:INTernal:FREQUency.....        | 116 |
| SOURce[1]:FM:DEVIation.....                 | 117 |
| Frequency-Shift Keying (FSK) Commands ..... | 119 |
| FSK Overview .....                          | 119 |
| SOURce[1]:FSKey:STATe.....                  | 119 |
| SOURce[1]:FSKey:SOURce .....                | 120 |
| SOURce[1]:FSKey:FREQUency .....             | 120 |
| SOURce[1]:FSKey:INTernal:RATE.....          | 121 |

|                                   |     |
|-----------------------------------|-----|
| Frequency Sweep Commands .....    | 123 |
| Sweep Overview .....              | 123 |
| SOURce[1]:SWEep:STATe .....       | 124 |
| SOURce[1]:FREQuency:START .....   | 124 |
| SOURce[1]:FREQuency:STOP .....    | 125 |
| SOURce[1]:SWEep:SPACing.....      | 126 |
| SOURce[1]:SWEep:RATE.....         | 126 |
| SOURce[1]:SWEep:SOURce.....       | 127 |
| Frequency Counter Commands .....  | 128 |
| COUNter:GATe .....                | 128 |
| COUNter:STATe .....               | 128 |
| COUNter:VALue? .....              | 129 |
| Arbitrary Waveform Commands ..... | 130 |
| Arbitrary Waveform Overview ..... | 130 |
| SOURce[1]:FUNctioN USER .....     | 131 |
| DATA:DAC .....                    | 131 |
| Save and Recall Commands .....    | 133 |
| *SAV .....                        | 133 |
| *RCL .....                        | 133 |

## System Commands

**\*IDN?**

→ Query

**Description** Returns the function generator manufacturer, model number, serial number and firmware version number in the following format:  
GW INSTEK,AFG-2025,SN:XXXXXXXX,Vm.mm

**Query Syntax** IDN?

**Return parameter** <string>

**Query Example** \*IDN?  
>GW INSTEK,AFG-2025,SN:XXXXXXXX,Vm.mm  
Returns the identification of the function generator.

**\*RST**

Set →

**Description** Reset the function generator to its factory default state.



Note

Note the \*RST command will not delete instrument save states/ ARB waveforms in memory.

**Syntax** \*RST



## Status Register Commands

\*CLS

Set →

---

|             |   |
|-------------|---|
| Description | The *CLS command clears all the event registers, the error queue and cancels an *OPC command. |
|-------------|---|

---

|        |             |
|--------|-------------|
| Syntax | <b>*CLS</b> |
|--------|-------------|

---

## Apply Commands

---

The APPLy command has 5 different types of outputs (Sine, Square, Ramp, Noise, User(ARB)). The Apply command is the quickest, easiest way to output waveforms remotely. Frequency, amplitude and offset can be specified for each function.

As only basic parameters can be set with the Apply command, other parameters, such as duty and symmetry use the instrument default values.

The Apply command will set the trigger source to immediate and disable modulation and sweep modes, if active. The command also turns on the output command SOURce[1]:OUTP ON.

As the frequency, amplitude and offset parameters are in nested square brackets, the amplitude can only be specified if the frequency has been specified and the offset can only be specified if the amplitude has been set. See the syntax below for the example:

```
SOURce1:APPLy:<function> [<frequency> [,<amplitude>
[,<offset>] ]]
```

---

**Output Frequency** For the output frequency, MINimum, MAXimum and DEFault can be used instead of specifying a frequency. The default frequency for all functions is set to 1 kHz.

The maximum and minimum frequency depends on the function used and the model of the frequency generator. If a frequency output that is out of range is specified, the max/min frequency will be used instead. A “-222” error will be generated from the remote terminal.

| Function | Min frequency | Max frequency |
|----------|---------------|---------------|
| Sine     | 0.1Hz         | 25MHz*        |

|            |                |                |
|------------|----------------|----------------|
| Square     | 0.1Hz          | 25MHz*         |
| Ramp       | 0.1Hz          | 1MHz           |
| Noise      | Not applicable | Not applicable |
| User (ARB) | 0.1Hz          | 20MHz          |

\*The AFG-2005/2105 is limited to 5MHz, the AFG-2012/2112 is limited to 12MHz.

#### Output Amplitude

When setting the amplitude, MINimum, MAXimum and DEFault can be used instead of specifying an amplitude. The range depends on the function being used. The default amplitude for all functions is 100 mVpp (into 50Ω).

Vrms, dBm or Vpp units can be used to specify the output units to use with the current command. Note, however, that the VOLT:UNIT command can be used to set the default units (Vrms, dBm, Vpp) for all commands. This will be applicable to the Apply command when no unit is specified. The unit default is set to Vpp.

The output amplitude can be affected by the function and unit chosen. Vpp and Vrms or dBm values may have different maximum values due to differences such as crest factor. For example, a 5Vrms square wave will be adjusted to 3.536 Vrms for a sine wave.

#### DC Offset voltage

The offset parameter can be set to MINimum, MAXimum or DEFault instead of a specified DC offset value. The default DC offset is 0 volts.

The maximum and minimum DC offset is limited by the output amplitude as shown below.

$$|V_{offset}| < V_{max} - V_{pp}/2$$

This means that the magnitude of the DC offset is determined by the output amplitude.

If the specified DC offset is out of range, the maximum/minimum offset will be set instead. A “-222” error will be generated from the remote terminal.

### SOURce[1]:APPLY:SINusoid

Set →

|             |   |                 |
|-------------|---|-----------------|
| Description | Outputs a sine wave when the command has executed. Frequency, amplitude and offset can also be set. |                 |
| Syntax      | SOURce[1]:APPLY:SINusoid [<frequency> [,<amplitude> [,<offset>] ]]                                  |                 |
| Parameter   | <frequency>   | 0.1Hz~25MHz*    |
|             | <amplitude>   | 1mV~10Vpp (50Ω) |
|             | <offset>  | -5V ~ +5V (50Ω) |
|             | *AFG-2005/2105 limited to 5MHz, AFG-2012/2112 limited to 12MHz.                                     |                 |

#### Example **SOURce1:APPL:SIN MAX, 3.0, -2.5**

Outputs a 3Vpp sine wave at 25MHz (max frequency) with a -2.5V offset.

### SOURce[1]:APPLY:SQUare

Set →

|             |   |                |
|-------------|---|----------------|
| Description | Outputs a square wave when the command has executed. Frequency, amplitude and offset can also be set. The duty cycle is fixed to 50%. |                |
| Syntax      | SOURce[1]:APPLY:SQUare [<frequency> [,<amplitude> [,<offset>] ]]  |                |
| Parameter   | <frequency>   | 0.1Hz ~ 25MHz* |
|             | <amplitude>   | 1mV~10V (50Ω)  |

<offset> -5V ~ +5V (50Ω)

\*AFG-2005/2105 limited to 5MHz, AFG-2012/2112 limited to 12MHz.

Example

**SOURce1:APPL:SQU MAX, DEF, DEF**

Outputs a 100mVpp (DEF) square wave at 25MHz with 0 offset (DEF).

**SOURce[1]:APPLy:RAMP**

**Set** →

Description

Outputs a ramp wave when the command has executed. Frequency, amplitude and offset can also be set. The symmetry is fixed to 100%.

Syntax

SOURce[1]:APPLy:RAMP [<frequency> [<amplitude> [<offset>] ]]

Parameter

<frequency> 0.1Hz~1MHz

<amplitude> 1mV~10V (50Ω)

<offset> -5V ~ +5V (50Ω)

Example

**SOUR1:APPL:RAMP 2KHZ,MAX,MAX**

Sets the frequency to 2kHz and sets the amplitude and offset to the maximum.

**SOURce[1]:APPLy:NOISe**

**Set** →

Description

Outputs Gaussian noise with a 20 MHz bandwidth. Amplitude and offset can also be set.

 **Note**

The Frequency parameter is not used with the noise function; however a value (or Default) *must still* be specified. The frequency is remembered for the next function used.

Syntax

SOURce[1]:APPLy:NOISe [<frequency|DEFAult> [<amplitude> [<offset>] ]]

Parameter

<frequency> 0.1Hz~25MHz\*

<amplitude> 1mV~10V (50Ω)

<offset> -5V ~ +5V (50Ω)

\*AFG-2005/2105 limited to 5MHz, AFG-2012/2112 limited to 12MHz.

**Example**      **SOURce1:APPL:NOIS DEF, 5.0, 2.0**

Sets the amplitude to 5 volts with an offset of 2 volts.

**SOURce[1]:APPLy:USER**



**Description**      Outputs an arbitrary waveform that is specified from the FUNC:USER command.

**Note**      Frequency and amplitude values are not used with this function; however a value (or DEFault) must be specified. The values are remembered for the next function used.

**Syntax**      **SOURce[1]:APPLy:USER [<frequency> [,<amplitude> [,<offset>] ]]**

|                  |             |                 |
|------------------|-------------|-----------------|
| <b>Parameter</b> | <frequency> | 0.1Hz~10MHz     |
|                  | <amplitude> | 1mV~10V (50Ω)   |
|                  | <offset>    | -5V ~ +5V (50Ω) |

**Example**      **SOUR1:APPL:USER**

Outputs the ARB waveform specified in the FUNC:USER command.

**SOURce[1]:APPLy?**



**Description**      Outputs a string with the current settings.

**Note**      The returned string can be passed back, when appended to the Apply Command. This is intended to be used to return the function generator to a known state.  
I.e., SOURce[1]:APPL:<passed back string>

**Query Syntax**      **SOURce[1]:APPLy?**

---

|                  |          |   |
|------------------|----------|---|
| Return Parameter | <string> | Function(<NRf>), frequency(<NRf>), amplitude(<NRf>),offset(<NRf>) |
|------------------|----------|---|

---

Query Example    **SOUR1:APPL?**  
**>SIN +5.00000000000000E+03,+3.0000E+00,-2.50E+00**

Returns a string with the current function and parameters, Sine, 5kHz, 3Vpp, -2.5V offset.

## Output Commands

Unlike the Apply commands, the Output commands are low level commands to program the function generator.

This section describes the low-level commands used to program the function generator. Even though the APPLY command is the easiest way to program the function generator, it lacks the ability to change individual parameters. The Output commands on the other hand can be used to set individual parameters, or those parameters that cannot be programmed with the Apply command.

### SOURce[1]:FUNction

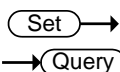

#### Description

The FUNction command selects and outputs the selected output function. The User parameter outputs an arbitrary waveform previously set by the SOURce[1]:FUNC:USER command. The previously set frequency, amplitude and offset values are used automatically.



Note

If the function mode is changed and the current frequency setting is not supported by the new mode, the frequency setting will be altered to the next highest value.

Vpp and Vrms or dBm amplitude values may have different maximum values due to differences such as crest factor. For example, if a 5Vrms square wave is changed to a sinewave, then the Vrms value is automatically adjusted to 3.536Vrms.

The modulation and sweep modes can only be used with some of the basic waveforms. If a mode is not supported, the conflicting mode will be disabled. See the table below.

|    | Sine | Square | Ramp | Noise | ARB |
|----|------|--------|------|-------|-----|
| AM | ✓    | ✓      | ✓    | ×     | ×   |
| FM | ✓    | ✓      | ✓    | ×     | ×   |



|                  |   |   |   |   |                                  |   |
|------------------|---|---|---|---|----------------------------------|---|
|                  | FSK   | ✓ | ✓ | ✓ | ×                                | × |
|                  | SWEEP   | ✓ | ✓ | ✓ | ×                                | × |
| Syntax           | <b>SOURce[1]:FUNction {SINusoid SQUare RAMP NOISe USER}</b>     |   |   |   |                                  |   |
| Example          | <b>SOUR1:FUNC SIN</b><br>Sets the output as a sine function.    |   |   |   |                                  |   |
| Query Syntax     | <b>SOURce[1]:FUNction?</b>                                      |   |   |   |                                  |   |
| Return Parameter | SIN, SQU, RAMP, NOIS, USER                                      |   |   |   | Returns the current output type. |   |
| Query Example    | <b>SOUR1:FUNC?</b><br><b>&gt;SIN</b><br>Current output is sine. |   |   |   |                                  |   |

**SOURce[1]:FREquency** 

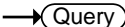
**Description** Sets the output frequency for the SOURce[1]:FUNction command. The query command returns the current frequency setting.

 **Note** The maximum and minimum frequency depends on the function mode.

|              |                |
|--------------|----------------|
| Sine, Square | 0.1Hz~25MHz*   |
| Ramp         | 0.1Hz ~ 1MHz   |
| Noise        | Not applicable |
| User         | 0.1Hz~10MHz*   |

\*AFG-2005/2105 limited to 5MHz, AFG-2012/2112 limited to 12MHz.

If the function mode is changed and the current frequency setting is not supported by the new mode, the frequency setting will be altered to the next highest value.

The duty cycle of square waveforms depends on the frequency settings:

1% to 99% (*frequency* < 100KHz)

20% to 80% (100KHz < *frequency* < 5 MHz)

40% to 60% (5 MHz < *frequency* < 10 MHz)

50% (*frequency* > 10 MHz)

If the frequency is changed and the set duty cycle cannot support the new frequency, the highest duty cycle available at that frequency will be used. A “-221” error will be generated from the remote terminal.

|                  |   |   |
|------------------|---|---|
| Syntax           | <b>SOURce[1]:FREQuency</b><br><b>{&lt;frequency&gt; MINimum MAXimum}</b>  |   |
| Example          | <b>SOUR1:FREQ MAX</b><br>Sets the frequency to the maximum for the current mode.  |   |
| Query Syntax     | <b>SOURce[1]:FREQuency?</b>   |   |
| Return Parameter | <NR3>   | Returns the frequency for the current mode. |
| Query Example    | <b>SOUR1:FREQ? MAX</b><br><b>&gt;+1.000000000000E+03</b><br>The maximum frequency that can be set for the current function is 1MHz. |   |

Set →

→ Query

**SOURce[1]:AMPLitude**

**Description** Sets the output amplitude for the SOURce[1]:FUNctioN command. The query command returns the current amplitude settings.



Note

The maximum and minimum amplitude depends on the output termination. The default amplitude for all functions is 100 mVpp (50Ω).

The offset and amplitude are related by the following equation.

$$|V_{offset}| < V_{max} - V_{pp}/2$$

The output amplitude can be affected by the function and unit chosen. Vpp and Vrms or dBm values may have different maximum values due to differences such as crest factor. For example, a 5Vrms square wave will be adjusted to 3.536 Vrms for a sine wave.

The amplitude units can be explicitly used each time the SOURce[1]:AMPLitude command is used. Alternatively, the VOLT:UNIT command can be used to set the amplitude units for *all* commands.

**Syntax** SOURce[1]:AMPLitude {< amplitude> |MINimum|MAXimum}

**Example** SOUR1:AMPL MAX  
Sets the amplitude to the maximum for the current mode.

**Query Syntax** SOURce[1]:AMPLitude? {MINimum|MAXimum}

**Return Parameter** <NR3> Returns the amplitude for the current mode.

**Query Example** SOUR1:AMPL? MAX  
>+5.0000E+00

The maximum amplitude that can be set for the current function is 5 volts.

**SOURce[1]:DCOffset** 

**Description** Sets or queries the DC offset for the current mode.

 **Note** The offset parameter can be set to MINimum or MAXimum. The default offset is 0 volts. The offset is limited by the output amplitude as shown below.

$$|V_{offset}| < V_{max} - V_{pp}/2$$

If the output specified is out of range, the maximum offset will be set.

The maximum offset is ±5V into 50Ω).



**Syntax** **SOURce[1]:DCOffset {< offset> |MINimum|MAXimum}**

**Example** **SOUR1:DCO MAX**  
Sets the offset to the maximum for the current mode.

**Query Syntax** **SOURce[1]:DCOffset? {MINimum|MAXimum}**

**Return Parameter** <NR3> Returns the offset for the current mode.

**Query Example** **SOUR1:DCO?**  
**>+3.0000E+00**  
The offset for the current mode is set to +3 volts.

**SOURce[1]:SQUare:DCYCLE** 

  

**Description** Sets or queries the duty cycle for square waves only. The setting is remembered if the function mode is changed. The default duty cycle is 50%.



 **Note** The duty cycle of square waveforms depend on the frequency settings.

- 1% to 99% (*frequency* < 100KHz)
- 20% to 80% (100KHz < *frequency* < 5 MHz)
- 40% to 60% (5 MHz < *frequency* < 10 MHz)
- 50% (*frequency* > 10 MHz)

If the frequency is changed and the set duty cycle cannot support the new frequency, the highest duty cycle available at that frequency will be used. A "-221" error will be generated from the remote terminal.

For square waveforms, the Apply command and AM/FM modulation modes ignore the duty cycle settings.

|                  |   |
|------------------|---|
| Syntax           | <b>SOURce[1]:SQUare:DCYcle {&lt; percent&gt;  MINimum MAXimum}</b>                                      |
| Example          | <b>SOUR1:SQU:DCYC MAX</b><br><br>Sets the duty cycle to the highest possible for the current frequency. |
| Query Syntax     | <b>SOURce[1]:SQUare:DCYcle? {MINimum MAXimum}</b>   |
| Return Parameter | <NR3> Returns the duty cycle as a percentage.   |
| Query Example    | <b>SOUR1:SQU:DCYC?</b><br><br><b>&gt;+5.00E+01</b><br><br>The duty cycle is set 50%.                    |

|   |   |
|---|---|
|  |   |
|  |   |
| <b>SOURce[1]:RAMP:SYMMetry</b>  |   |
| Description   | <p>Sets or queries the symmetry for ramp waves only. The setting is remembered if the function mode is changed. The default symmetry is 100%. 0% symmetry is a ramp waveform with a negative going transition. 100% symmetry is a ramp waveform with a positive going transition.</p> |

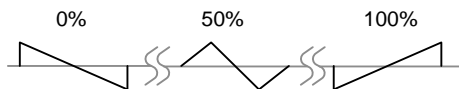

Note

For ramp waveforms, the Apply command and AM/FM modulation modes ignore the current symmetry settings.

**Syntax**                **SOURce[1]:RAMP:SYMMetry {< percent> |MINimum|MAXimum}**

**Example**                **SOUR[1]:RAMP:SYMM MAX**  
Sets the symmetry to the 100%.

**Query Syntax**        **SOURce[1]:RAMP:SYMMetry? {MINimum|MAXimum}**

**Return Parameter** <NR3> Returns the symmetry as a percentage.

**Query Example**        **SOUR1:RAMP:SYMMetry?**  
**>+1.0000E+02**  
The symmetry is set as 100%.

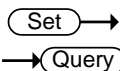

## OUTPut

**Description**            Enables/Disables or queries the front panel output. The default is set to off.

**Syntax**                **OUTPut {OFF|ON}**

**Example**                **OUTP ON**  
Turns the output on.

**Query Syntax**        **OUTPut?**

**Return Parameter** 1        ON  
0        OFF

**Query Example**        **OUTP?**  
**>1**  
The output is currently on.

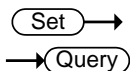

**SOURce[1]:VOLTage:UNIT**

**Description** Sets or queries the output amplitude units. There are three types of units: VPP, VRMS and DBM. The SOURce[1]:VOLTage:UNIT command does not set the offset units.

 **Note** The units set with the VOLTage:UNIT command will be used as the default unit for all amplitude units unless a different unit is specifically used for a command, such as those used with the Apply commands.

**Syntax** **SOURce[1]:VOLTage:UNIT {VPP|VRMS|DBM}**

**Example** **SOUR1:VOLT:UNIT VPP**  
Sets the amplitude units to Vpp.

**Query Syntax** **SOURce[1]:VOLTage:UNIT?**

|                         |      |      |
|-------------------------|------|------|
| <b>Return Parameter</b> | VPP  | Vpp  |
|                         | VRMS | Vrms |
|                         | DBM  | dBm  |

**Query Example** **SOUR1:VOLT:UNIT?**  
**>VPP**  
The amplitude units are set to Vpp.

## Amplitude Modulation (AM) Commands

### AM Overview

---

To successfully create an AM waveform, the following commands must be executed in order.

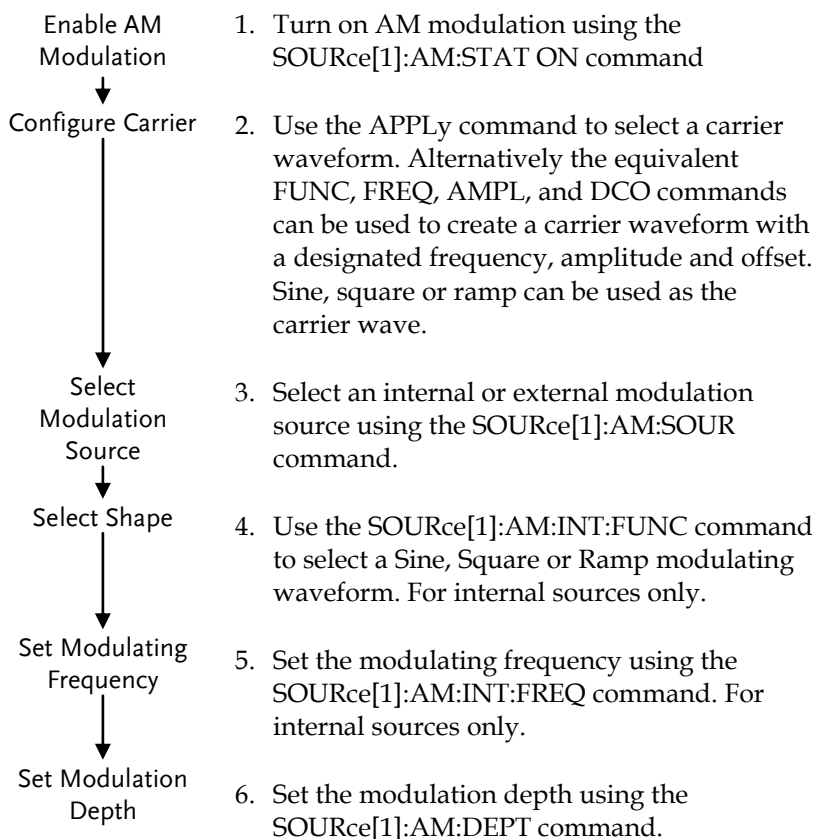



**SOURce[1]:AM:STATe** 



**Description** Sets or disables AM modulation. By default AM modulation is disabled. AM modulation must be enabled before setting other parameters.

 **Note** As only one mode is allowed at any one time, other modulation modes (inc. Sweep/FSK) will be disabled when AM modulation is enabled.

**Syntax** **SOURce[1]:AM:STATe {OFF|ON}**

**Example** **SOUR1:AM:STAT ON**  
 Enables AM modulation.

**Query Syntax** **SOURce[1]:AM:STATe?**

|                         |   |                |
|-------------------------|---|----------------|
| <b>Return Parameter</b> | 0 | Disabled (OFF) |
|                         | 1 | Enabled (ON)   |

**Query Example** **SOUR1:AM:STAT?**  
**>1**  
 AM modulation mode is currently enabled.

**SOURce[1]:AM:SOURce** 



**Description** Sets or queries the modulation source as internal or external. Internal is the default modulation source.

 **Note** If an external modulation source is selected, modulation depth is limited to  $\pm 5V$  from the MOD input port on the rear panel. For example, if modulation depth is set to 100%, then the maximum amplitude is +5V, and the minimum amplitude is -5V.

**Syntax** **SOURce[1]:AM:SOURce {INTernal|EXTernal}**

**Example** **SOUR1:AM:SOUR EXT**  
 Sets the modulation source to external.

Query Syntax **SOURce[1]:AM:SOURce?**

|                  |     |          |
|------------------|-----|----------|
| Return Parameter | INT | Internal |
|                  | EXT | External |

Query Example **SOUR1:AM:SOUR?**  
**>INT**

The modulation source is set to internal.

(Set) →

→ (Query)

**SOURce[1]:AM:INTernal:FUNcTion**

Description Sets the shape of the modulating waveform from sine, square or ramp. The default shape is sine.

 **Note** Square waveforms have a 50% duty cycle. Ramp waveforms have a symmetry of 100%.

Syntax **SOURce[1]:AM:INTernal:FUNcTion**  
**{SINusoid|SQUare| RAMP }**

Example **SOUR1:AM:INT:FUNC SIN**  
Sets the AM modulating wave shape to sine.

Query Syntax **SOURce[1]:AM:INTernal:FUNcTion?**

|                  |      |        |
|------------------|------|--------|
| Return Parameter | SIN  | Sine   |
|                  | SQU  | Square |
|                  | RAMP | Ramp   |

Query Example **SOUR1:AM:INT:FUNC?**  
**>SIN**

The shape for the modulating waveform is Sine.

(Set) →

→ (Query)

**SOURce[1]:AM:INTernal:FREQUency**

Description Sets the frequency of the internal modulating waveform only. The default frequency is 100Hz.

Syntax **SOURce[1]:AM:INTernal:FREQUency**  
**{<frequency>|MINimum|MAXimum}**

|                  |   |                              |
|------------------|---|------------------------------|
| Parameter        | <frequency>   | 2 mHz~ 20 kHz                |
| Example          | <b>SOUR1:AM:INT:FREQ +1.0000E+02</b><br>Sets the modulating frequency to 100Hz.                   |                              |
| Query Syntax     | <b>SOURce[1]:AM:INTernal:FREQuency?</b><br><b>[MINimum MAXimum]</b>                               |                              |
| Return Parameter | <NR3>   | Returns the frequency in Hz. |
| Query Example    | <b>SOUR1:AM:INT:FREQ? MIN</b><br><b>&gt;+1.0000E+02</b><br>Returns the minimum frequency allowed. |                              |

**SOURce[1]:AM:DEPTH** 

  

|  |  |  |
|--|--|--|
| Description  | Sets or queries the modulation depth for internal sources only. The default is 100%.   |  |
|  Note | <p>The function generator will not output more than <math>\pm 5V</math>, regardless of the modulation depth.</p> <p>The modulation depth of an external source is controlled using the <math>\pm 5V</math> MOD input port on the rear panel, and not the SOURce[1]:AM:DEPTH command.</p> |  |
| Syntax   | <b>SOURce[1]:AM:DEPTH {&lt;depth in percent&gt;  MINimum MAXimum}</b>  |  |
| Parameter  | <depth in percent>   | 0~120%                                       |
| Example  | <b>SOUR1:AM:DEPT 50</b><br>Sets the modulation depth to 50%.   |  |
| Query Syntax   | <b>SOURce[1]:AM:DEPTH? [MINimum MAXimum]</b>   |  |
| Return Parameter   | <NR3>  | Return the modulation depth as a percentage. |
| Query Example  | <b>SOUR1:AM:DEPT?</b><br><b>&gt;+1.0000E+02</b><br>The modulation depth is 100%.   |  |

## Frequency Modulation (FM) Commands

### FM Overview

The following is an overview of the steps required to generate an FM waveform.

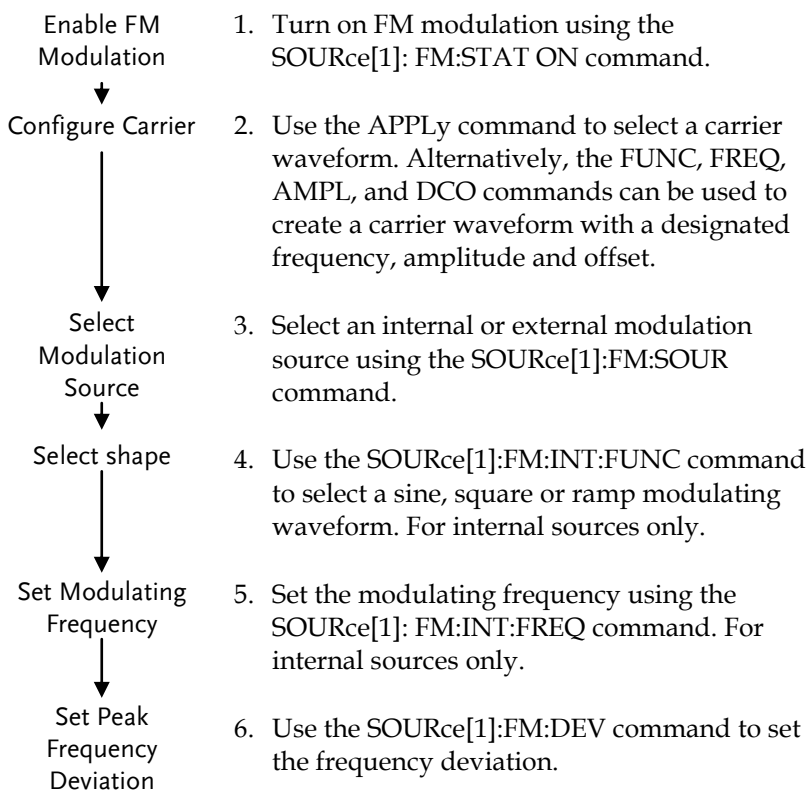

`SOURce[1]:FM:STATe` 

|             |  |
|-------------|--|
| Description | Sets or disables FM modulation. By default FM modulation is disabled. FM modulation must be enabled before setting other parameters. |
|-------------|--|



Note

As only one mode is allowed at any one time, other modes (AM, FSK, Sweep etc.) will be disabled when FM modulation is enabled.

Syntax

**SOUR[1]:FM:STATe {OFF|ON}**

Example

**SOUR1:FM:STAT ON**

Enables FM modulation.

Query Syntax

**SOURce[1]:FM:STATe?**

Return Parameter

|   |                |
|---|----------------|
| 0 | Disabled (OFF) |
|---|----------------|

|   |              |
|---|--------------|
| 1 | Enabled (ON) |
|---|--------------|

Query Example

**SOUR1:FM:STAT?**

>1

FM modulation mode is currently enabled.

Set →

→ Query

**SOURce[1]:FM:SOURce**

Description

Sets or queries the modulation source as internal or external. Internal is the default modulation source.



Note

If an external modulation source is selected, the frequency deviation is limited to  $\pm 5V$  from the MOD input port on the rear panel. For example, if frequency deviation is set to 100Hz, then +5V will increase the frequency by 100Hz.

Syntax

**SOURce[1]:FM:SOURce {INTernal|EXTernal}**

Example

**SOUR1:FM:SOUR EXT**

Sets the modulation source to external.

Query Syntax

**SOURce[1]:FM:SOURce?**

Return Parameter

|     |          |
|-----|----------|
| INT | Internal |
|-----|----------|



|     |          |
|-----|----------|
| EXT | External |
|-----|----------|

Query Example

**SOUR1:FM:SOUR?**

>INT

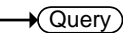
The modulation source is set to internal.

|  |   |
|--|---|
|       |   |
|       |   |
| <b>SOURce[1]:FM:INTernal:FUNcTion</b>  |   |
| Description  | Sets the shape of the modulating waveform from sine, square or ramp. The default shape is sine. |
|  Note | Square waveforms have a 50% duty cycle. Ramp waveforms have a symmetry of 100%.                 |
| Syntax   | <b>SOURce[1]:FM:INTernal:FUNcTion {SINusoid SQUare RAMP }</b>                                   |
| Example  | <b>SOUR1:FM:INT:FUNC SIN</b><br>Sets the FM modulating wave shape to sine.                      |
| Query Syntax   | <b>SOURce[1]:FM:INTernal:FUNcTion?</b>  |
| Return Parameter   | SIN Sine<br>SQU Square<br>RAMP Ramp   |
| Query Example  | <b>SOUR1:FM:INT:FUNC?</b><br><b>&gt;SIN</b><br>The shape for the modulating waveform is Sine.   |

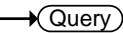
|  |   |
|--|---|
|   |   |
|  |   |
| <b>SOURce[1]:FM:INTernal:FREQuency</b>   |   |
| Description  | Sets the frequency of the internal modulating waveform only. The default frequency is 10Hz. |
| Syntax   | <b>SOURce[1]:FM:INTernal:FREQuency {&lt;frequency&gt; MINimum MAXimum}</b>                  |
| Parameter  | <frequency> 2 mHz ~ 20 kHz  |
| Example  | <b>SOUR1:FM:INT:FREQ +1.0000E+02</b><br>Sets the modulating frequency to 100Hz.             |
| Query Syntax   | <b>SOURce[1]:FM:INTernal:FREQuency? [MINimum MAXimum]</b>                                   |

Return Parameter <NR3> Returns the frequency in Hz.

Query Example **SOUR1:FM:INT:FREQ? MAX**  
**>+2.0000E+04**  
 Returns the maximum frequency allowed.

**SOURce[1]:FM:DEVIation** (Set) →  
 → (Query)

**Description** Sets or queries the peak frequency deviation of the modulating waveform from the carrier waveform. The default peak deviation is 100Hz.

The frequency deviation of external sources is controlled using the ±5V MOD INPUT terminal on the rear panel. A positive signal (>0~+5V) will increase the deviation (up to the set frequency deviation), whilst a negative voltage will reduce the deviation.

 **Note** The relationship of peak deviation to modulating frequency and carrier frequency is shown below.

Peak deviation = modulating frequency - carrier frequency.

The carrier frequency must be greater than or equal to the peak deviation frequency. The sum of the deviation and carrier frequency must not exceed the maximum frequency for a specific carrier shape + 1kHz. If an out of range deviation is set for any of the above conditions, the deviation will be automatically adjusted to the maximum value allowed and an "out of range" error will be generated.

For square wave carrier waveforms, the deviation may cause the duty cycle frequency boundary to be exceeded. In these conditions the duty cycle will be adjusted to the maximum allowed and a "-221" error will be generated.

|                  |   |  |
|------------------|---|--|
| Syntax           | <b>SOURce[1]:FM:DEVIation {&lt;peak deviation in Hz&gt; MINimum MAXimum}</b>  |  |
| Parameter        | <peak deviation in Hz>  | DC ~ 25MHz*<br>DC~1MHz (Ramp)          |
|                  | *Limited to 12MHz for AFG-2112, 5MHz for AFG-2105.  |  |
| Example          | <b>SOUR1:FM:DEV MAX</b><br>Sets the frequency deviation to the maximum value allowed.   |  |
| Query Syntax     | <b>SOURce[1]:FM:DEVIation? [MINimum MAXimum]</b>  |  |
| Return Parameter | <NR3>   | Returns the frequency deviation in Hz. |
| Query Example    | <b>SOURce1:FM:DEVIation? MAX</b><br><b>&gt;+1.0000E+06</b><br>The maximum frequency deviation for the current function is 1MHz. |  |



# Frequency-Shift Keying (FSK) Commands

## FSK Overview

The following is an overview of the steps required to generate an FSK modulated waveform.

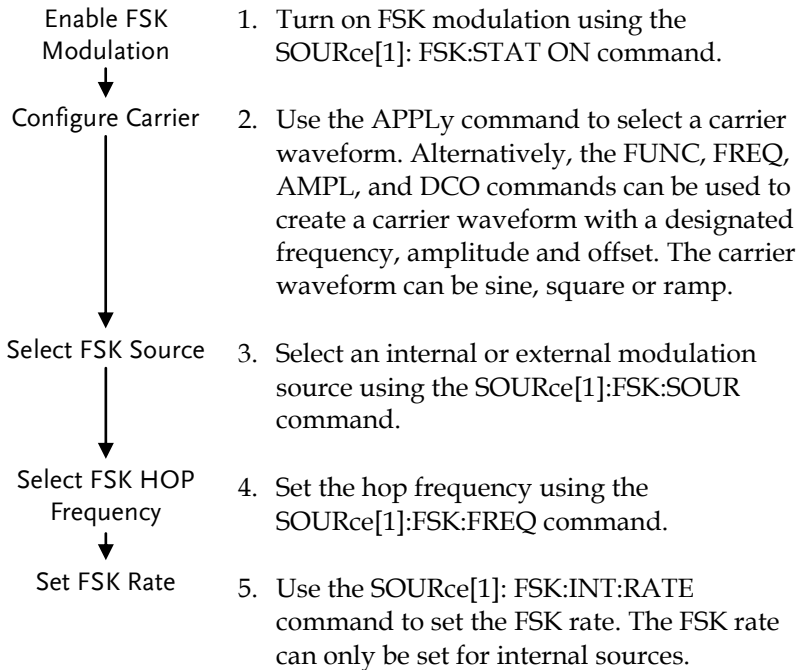

SOURce[1]:FSKey:STATe 
 Set →  
 ←  Query

|             |   |
|-------------|---|
| Description | Turns FSK Modulation on or off. By default FSK modulation is off. |
|-------------|---|

|  |  |
|--|--|
|  Note | As only one mode is allowed at any one time, other modes (AM, FM, Sweep etc.) will be disabled when FSK modulation is enabled. |
|--|--|

|        |                                       |
|--------|---------------------------------------|
| Syntax | <b>SOURce[1]:FSKey:STATe {OFF ON}</b> |
|--------|---------------------------------------|

|                  |  |                |
|------------------|--|----------------|
| Example          | <b>SOUR1:FSK:STAT ON</b>   |                |
|                  | Enables FSK modulation.  |                |
| Query Syntax     | <b>SOURce[1]:FSKey:STATe?</b>  |                |
| Return Parameter | 0  | Disabled (OFF) |
|                  | 1  | Enabled (ON)   |
| Query Example    | <b>SOUR1:FSK:STAT?</b><br><b>&gt;1</b><br>FSK modulation is currently enabled. |                |

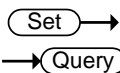

**SOURce[1]:FSKey:SOURce**

|             |   |  |
|-------------|---|--|
| Description | Sets or queries the FSK source as internal or external. Internal is the default source. |  |
|-------------|---|--|

 **Note** If an external FSK source is selected, FSK rate is controlled by the Trigger input port on the rear panel.

|        |   |  |
|--------|---|--|
| Syntax | <b>SOURce[1]:FSKey:SOURce {INTernal EXTernal}</b> |  |
|--------|---|--|

|         |   |  |
|---------|---|--|
| Example | <b>SOUR1:FSK:SOUR EXT</b><br>Sets the FSK source to external. |  |
|---------|---|--|

|              |                                |  |
|--------------|--------------------------------|--|
| Query Syntax | <b>SOURce[1]:FSKey:SOURce?</b> |  |
|--------------|--------------------------------|--|

|                  |     |          |
|------------------|-----|----------|
| Return Parameter | INT | Internal |
|                  | EXT | External |

|               |  |  |
|---------------|--|--|
| Query Example | <b>SOUR1:FSK:SOUR?</b><br><b>&gt;INT</b><br>The FSK source is set to internal. |  |
|---------------|--|--|

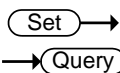

**SOURce[1]:FSKey:FREQuency**

|             |  |  |
|-------------|--|--|
| Description | Sets the FSK hop frequency. The default hop frequency is set to 100Hz. |  |
|-------------|--|--|

|  |  |
|--|--|
|  Note | For FSK, the modulating waveform is a square wave with a duty cycle of 50%.                        |
| Syntax   | <b>SOURce[1]:FSKey:FREQuency</b><br><b>{&lt;frequency&gt; MINimum MAXimum}</b>                     |
| Parameter  | <frequency> 0.1Hz~ 25MHz*<br>0.1Hz~ 1MHz (Ramp)  |
|  | *AFG-2112 limited to 12MHz, AFG-2105 limited to 5MHz.  |
| Example  | <b>SOUR1:FSK:FREQ +1.0000E+02</b><br>Sets the FSK hop frequency to 100Hz.                          |
| Query Syntax   | <b>SOURce[1]:FSKey:FREQuency?</b><br><b>[MINimum MAXimum]</b>                                      |
| Return Parameter   | <NR3> Returns the frequency in Hz.   |
| Query Example  | <b>SOUR1:FSK:FREQ? MAX</b><br><b>&gt;+2.0000E+07</b><br>Returns the maximum hop frequency allowed. |

**SOURce[1]:FSKey:INTernal:RATE** 
 →  
 → 

|  |  |
|--|--|
| Description  | Sets or queries the FSK rate for internal sources only.                        |
|  Note | External sources will ignore this command.                                     |
| Syntax   | <b>SOURce[1]:FSKey:INTernal:RATE</b> {<rate in Hz><br><b> MINimum MAXimum}</b> |
| Parameter  | <rate in Hz> 2 mHz~100 kHz   |
| Example  | <b>SOUR1:FSK:INT:RATE MAX</b><br>Sets the rate to the maximum (100kHz).        |
| Query Syntax   | <b>SOURce[1]:FSKey:INTernal:RATE?</b><br><b>[MINimum MAXimum]</b>              |
| Return Parameter   | <NR3> Returns the FSK rate in Hz.  |

Query example **SOUR1:FSK:INT:RATE?**

**>+1.0000E+05**

Returns the FSK rate (100kHz).

# Frequency Sweep Commands

## Sweep Overview

Below shows the order in which commands must be executed to perform a sweep.

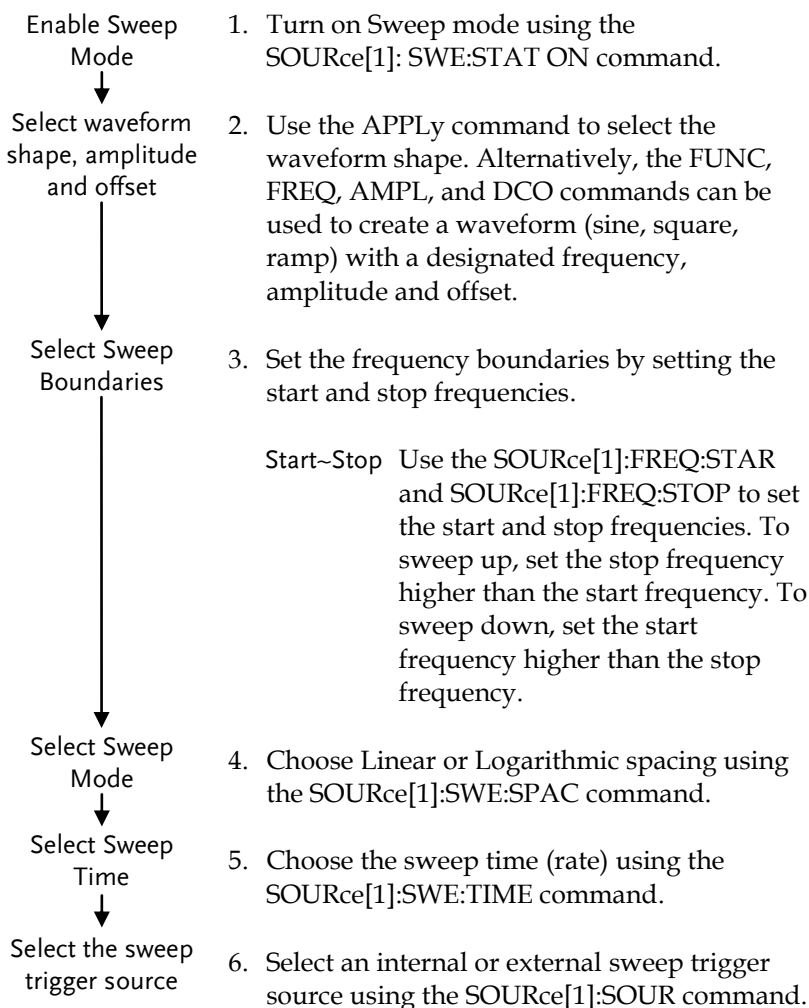

Set →  
→ Query

---

**SOURce[1]:SWEep:STATe**

---

|  |   |                |  |                |   |  |              |
|--|---|----------------|--|----------------|---|--|--------------|
| Description  | Sets or disables Sweep mode. By default sweep is disabled. Sweep must be enabled before setting other parameters.   |                |  |                |   |  |              |
|  Note | Any modes will be disabled if sweep mode is enabled.  |                |  |                |   |  |              |
| Syntax   | <b>SOURce[1]:SWEep:STATe {OFF ON}</b>   |                |  |                |   |  |              |
| Example  | <b>SOUR1:SWE:STAT ON</b><br>Enables sweep mode.   |                |  |                |   |  |              |
| Query Syntax   | <b>SOURce[1]:SWEep:STATe?</b>   |                |  |                |   |  |              |
| Return Parameter   | <table border="0" style="width: 100%; border-collapse: collapse;"> <tr> <td style="width: 10%; text-align: center;">0</td> <td style="width: 10%;"></td> <td>Disabled (OFF)</td> </tr> <tr> <td style="text-align: center;">1</td> <td></td> <td>Enabled (ON)</td> </tr> </table> | 0              |  | Disabled (OFF) | 1 |  | Enabled (ON) |
| 0  |   | Disabled (OFF) |  |                |   |  |              |
| 1  |   | Enabled (ON)   |  |                |   |  |              |
| Query Example  | <b>SOUR1:SWE:STAT?</b><br><b>&gt;1</b><br>Sweep mode is currently enabled.  |                |  |                |   |  |              |

Set →  
→ Query

---

**SOURce[1]:FREQuency:STARt**

---

|  |   |                          |  |                |  |  |                     |
|--|---|--------------------------|--|----------------|--|--|---------------------|
| Description  | Sets the start frequency of the sweep. 100Hz is the default start frequency.  |                          |  |                |  |  |                     |
|  Note | To sweep up set the stop frequency higher than the start frequency. Set the stop frequency lower than the start frequency to sweep down.  |                          |  |                |  |  |                     |
| Syntax   | <b>SOURce[1]:FREQuency:STARt {&lt;frequency&gt; MINimum MAXimum}</b>  |                          |  |                |  |  |                     |
| Parameter  | <table border="0" style="width: 100%; border-collapse: collapse;"> <tr> <td style="width: 15%;"><b>&lt;frequency&gt;</b></td> <td style="width: 15%;"></td> <td>0.1Hz ~ 25MHz*</td> </tr> <tr> <td></td> <td></td> <td>0.1Hz ~ 1MHz (Ramp)</td> </tr> </table> <p>*AFG-2112 limited to 12MHz, AFG-2105 limited to 5MHz.</p> | <b>&lt;frequency&gt;</b> |  | 0.1Hz ~ 25MHz* |  |  | 0.1Hz ~ 1MHz (Ramp) |
| <b>&lt;frequency&gt;</b>   |   | 0.1Hz ~ 25MHz*           |  |                |  |  |                     |
|  |   | 0.1Hz ~ 1MHz (Ramp)      |  |                |  |  |                     |

|                  |   |
|------------------|---|
| Example          | <b>SOUR1:FREQ:STAR +2.0000E+03</b><br>Sets the start frequency to 2kHz.                               |
| Query Syntax     | <b>SOURce[1]:FREQuency:STAR? [MINimum] MAXimum]</b>   |
| Return Parameter | <NR3> Returns the start frequency in Hz.  |
| Query Example    | <b>SOUR1:FREQ:STAR? MAX</b><br><b>&gt;+2.0000E+07</b><br>Returns the maximum start frequency allowed. |

Set →

→ Query

**SOURce[1]:FREQuency:STOP**

|             |   |
|-------------|---|
| Description | Sets the stop frequency of the sweep. 1 kHz is the default start frequency. |
|-------------|---|

|  |  |
|--|--|
|  Note | To sweep up set the stop frequency higher than the start frequency. Set the stop frequency lower than the start frequency to sweep down. |
|--|--|

|        |   |
|--------|---|
| Syntax | <b>SOURce[1]:FREQuency:STOP</b><br><b>{&lt;frequency&gt; MINimum MAXimum}</b> |
|--------|---|

|           |   |
|-----------|---|
| Parameter | <frequency> 0.1Hz ~ 25MHz*<br>0.1Hz ~ 1MHz (Ramp)     |
|           | *AFG-2112 limited to 12MHz, AFG-2105 limited to 5MHz. |

|               |  |
|---------------|--|
| Query Example | <b>SOUR1:FREQ:STOP +2.0000E+03</b><br>Sets the stop frequency to 2kHz. |
|---------------|--|

|              |   |
|--------------|---|
| Query Syntax | <b>SOURce[1]:FREQuency:STOP? [MINimum] MAXimum]</b> |
|--------------|---|

|                  |   |
|------------------|---|
| Return Parameter | <NR3> Returns the stop frequency in Hz. |
|------------------|---|

|         |  |
|---------|--|
| Example | <b>SOUR1:FREQ:STOP? MAX</b><br><b>&gt;+2.0000E+07</b><br>Returns the maximum stop frequency allowed. |
|---------|--|

Set →  
 → Query

**SOURce[1]:SWEep:SPACing**

---

|                  |   |                     |
|------------------|---|---------------------|
| Description      | Sets linear or logarithmic sweep spacing. The default spacing is linear.            |                     |
| Syntax           | <b>SOURce[1]:SWEep:SPACing {LINear LOGarithmic}</b>                                 |                     |
| Example          | <b>SOUR1:SWE:SPAC LIN</b><br>Sets the spacing to linear.                            |                     |
| Query Syntax     | <b>SOURce[1]:SWEep:SPACing?</b>   |                     |
| Return Parameter | LIN   | Linear spacing      |
|                  | LOG   | Logarithmic spacing |
| Query Example    | <b>SOUR1:SWE:SPAC?</b><br><b>&gt;LIN</b><br>The spacing is currently set as linear. |                     |

Set →  
 → Query

**SOURce[1]:SWEep:RATE**

---

|   |   |   |
|---|---|---|
| Description   | Sets or queries the sweep rate. The default sweep rate is 100 Hz. This command is the equivalent to using the Rate function on the front panel. |   |
|  Note | The function generator automatically determines the number of frequency points that are used for the sweep based on the sweep rate.             |   |
| Syntax  | <b>SOURce[1]:SWEep:RATE {&lt;Hz&gt; MINimum MAXimum}</b>  |   |
| Parameter   | <Hz>  | 2mHz ~1kHz (equivalent to a sweep time of 500s ~ 1ms) |
| Example   | <b>SOUR1:SWE:RATE +1.0000E+00</b><br>Sets the rate to 1 Hz (1 second).  |   |
| Query Syntax  | <b>SOURce[1]:SWEep:RATE? {&lt;Hz&gt; MINimum MAXimum}</b>   |   |
| Return Parameter  | <NR3>   | Returns sweep rate in Hz.                             |





## Frequency Counter Commands

Set →

→ Query

### COUNter:GATe

**Description** Sets or queries the gate time for the frequency counter function.

 **Note** The counter function is only applicable for the AFG-21XX models.

**Syntax** COUNter:GATe <seconds>

**Parameter** <seconds> 0.01S, 0.1S, 1S, 10S

**Example** COUN:GAT 10S  
Sets the gate time to 10 seconds.

**Query Syntax** COUNter:GATe?

**Return Parameter** <NR3> Returns the gate time in seconds.

**Query Example** COUN:GAT?  
>1.000E-02  
The gate time is current set to 0.01 second.

Set →

→ Query

### COUNter:STATe

**Description** Turns the frequency counter on/off.

**Syntax** COUNter:STATe [ON/OFF]

 **Note** The counter function is only applicable for the AFG-21XX models.

**Parameter** ON Turns the counter function on.  
OFF Turns the counter function off.

**Example** COUN:STAT ON  
Turns the frequency counter on.

**Query Syntax** COUNter:STATe?

|                  |   |                          |
|------------------|---|--------------------------|
| Return Parameter | 0 | Counter function is off. |
|                  | 1 | Counter function is on.  |

Query Example    **COUN:STAT?**  
                          **>1**  
                          Counter is on.

**COUNter:VALue?** → **Query**

Description        Queries the counter frequency.

 **Note**        The counter function is only applicable for the AFG-21XX models.

Syntax                **COUNter:VALue?**

Return Parameter    **<NR3>**        Returns the counter frequency.

Example                **COUN:VAL?**  
                          **>1.000E+03**  
                          The counter frequency is 1kHz.

# Arbitrary Waveform Commands

## Arbitrary Waveform Overview

Use the steps below to output an arbitrary waveform over the remote interface.

- |   |  |
|---|--|
| Output Arbitrary Waveform                       | 1. Use the SOURce[1]:FUNCtion USER command to output the arbitrary waveform currently selected in memory.  |
| ↓   |  |
| Select Waveform Frequency, amplitude and offset | 2. Use the APPLY command to select frequency, amplitude and DC offset. Alternatively, the FUNC, FREQ, AMPL, and DCO commands can be used.  |
| ↓   |  |
| Load Waveform Data                              | 3. Waveform data (4k points per waveform) can be downloaded into volatile memory using the DATA:DAC command. Binary integer or decimal integer values in the range of ± 511 can be used. |
| ↓   |  |
| Set Waveform Rate                               | 4. The waveform rate is the product of the number of points in the waveform and the waveform frequency.  |

$$\text{Rate} = \text{Frequency} \times \# \text{ points}$$

|        |            |               |
|--------|------------|---------------|
| Range: | Rate:      | 0.1Hz ~ 20MHz |
|        | Frequency: | 0.1Hz ~ 10MHz |
|        | # points:  | 2~4096        |

Set →

→ Query

**SOURce[1]:FUNctIon USER**

**Description** Use the SOURce[1]:FUNctIon USER command to output the arbitrary waveform currently selected in memory. The waveform is output with the current frequency, amplitude and offset settings. The query returns the current output.

**Syntax** **SOURce[1]:FUNctIon USER**

**Example** **SOUR1:FUNC USER**  
 Selects and outputs the current waveform in memory.

**Query Syntax** **SOURce[1]:FUNctIon?**

|                         |      |                |
|-------------------------|------|----------------|
| <b>Return Parameter</b> | SIN  | Sine wave      |
|                         | SQU  | Square wave    |
|                         | RAMP | Ramp wave      |
|                         | NOIS | Noise wave     |
|                         | ARB  | Arbitrary wave |

**Query Example** **SOURce1:FUNctIon?**  
**>SQU**  
 A square waveform is the current output.

**DATA:DAC**

Set →

**Description** The DATA:DAC command is used to download binary or decimal integer values into memory using the IEEE-488.2 binary block format or as an ordered list of values. After the values have been downloaded into memory the SOURce[1]:FUNctIon USER command can be used to output the ARB waveform in memory.



**Note**

The integer values ( $\pm 511$ ) correspond to the maximum and minimum peak amplitudes of the

waveform. For instance, for a waveform with an amplitude of 5V<sub>pp</sub> (0 offset), the value 511 is the equivalent of 2.5 Volts and -511 is the equivalent of -2.5V. If the integer values do not span the full output range, the peak amplitude will be limited.

The IEEE-488.2 binary block format is comprised of three parts:

|                        |   |
|------------------------|---|
| #216<br>     <br>a b c | a. Initialization character (#)                   |
|                        | b. Digit length (in ASCII) of the number of bytes |
|                        | c. Number of bytes                                |

IEEE 488.2 binary block format uses two bytes to represent waveform data (16 bit integer). Therefore the number of bytes is always twice the number of data points. In the example above, the data block represents 8 data points.

|           |  |   |
|-----------|--|---|
| Syntax    | <b>DATA:DAC VOLATILE, &lt;start&gt;, {&lt;binary block&gt; &lt;value&gt;, &lt;value&gt;, . . . }</b> |   |
| Parameter | <start>  | Start address of the arbitrary waveform |
|           | <binary block>   | Points 2~4096 in binary block format    |
|           | <value>  | Decimal or integer values ±511          |

**Example1 DATA:DAC VOLATILE, 1000, #216 Binary Data**  
 The command above downloads 8 integer points stored in 16 bytes to memory 1000 using the binary block format.

**Example2 DATA:DAC VOLATILE, 1000, 511, 206, 0, -206, -511, -206, 0, 206**  
 The command above downloads the data values (511, 206, 0, -206, -511, -206, 0, 206) to address 1000 using the ordered list method.

## Save and Recall Commands

Up to 10 different instrument states can be stored to non-volatile memory (# 0~9) and up to 10 different ARB waveforms can be saved to memory locations 10~19.

### \*SAV



**Description** Saves the current instrument state to a specified save location or an ARB waveform to the specified location. When a state is saved, all the current instrument settings, functions, modulation parameters and waveforms are also saved. Memory locations 0~9, save the instrument state only, whilst memory locations 10~19 save ARB data.



Note

The \*RST command will not delete saved instrument states from memory.

**Syntax** \*SAV {NR1}

|                  |       |               |
|------------------|-------|---------------|
| <b>Parameter</b> | 0~9   | Save state    |
|                  | 10~19 | Save ARB data |

**Example** \*SAV 0

Save the instrument state to memory location 0.

### \*RCL



**Description** Recall previously saved instrument states from memory locations 0~9 or recall the previously saved ARB waveforms from memory locations 10~19.

**Syntax** \*RCL {NR1}

|                  |       |                 |
|------------------|-------|-----------------|
| <b>Parameter</b> | 0~9   | Recall state    |
|                  | 10~19 | Recall ARB data |

---

Example

**\*RCL 0**

Recall the instrument state from memory location 0 (assuming location 0 has been previously saved).



# APPENDIX

## Error Messages

---

The AFG-2000 has a number of specific error codes. If a setting error occurs whilst using the function generator, an error message will be momentarily displayed on the screen.

### Interface Error Messages

---

| Error code | Description  |
|------------|--|
| E01        | Frequency forced duty cycle change.                    |
| E02        | Frequency reduced for ramp function                    |
| E03        | Frequency made compatible with FM                      |
| E04        | Frequency made compatible with FSK                     |
| E05        | Frequency made compatible with Sweep                   |
| E06        | Mod function cannot be performed under current setting |
| E07        | Frequency over range                                   |
| E08        | Frequency over resolution                              |
| E09        | Amplitude over range                                   |
| E10        | Amplitude over resolution                              |
| E11        | Offset over range                                      |
| E12        | Offset over resolution                                 |
| E13        | Duty over range  |
| E14        | Duty over resolution                                   |

|     |  |
|-----|--|
| E15 | ARB frequency over range                 |
| E16 | ARB frequency over resolution            |
| E17 | ARB rate over range                      |
| E18 | ARB rate over resolution                 |
| E19 | ARB point over range                     |
| E20 | ARB point over resolution                |
| E21 | ARB value over range                     |
| E22 | ARB value over resolution                |
| E23 | Mod rate over range                      |
| E24 | Mod rate over resolution                 |
| E25 | Mod sym over range                       |
| E26 | Mod sym over resolution                  |
| E27 | AM depth over range                      |
| E28 | AM depth over resolution                 |
| E29 | FM deviation over range                  |
| E30 | FM deviation over resolution             |
| E31 | FSK hop frequency over range             |
| E32 | FSK hop frequency over resolution        |
| E33 | Sweep frequency over range               |
| E34 | Sweep frequency over resolution          |
| E35 | Sweep rate over range                    |
| E36 | Sweep rate over resolution               |
| E37 | Save setting over setting number range   |
| E38 | Recall setting over setting number range |
| E39 | Recall set has no data                   |
| E40 | Value over resolution                    |
| E41 | Queue overflow                           |

## AFG-2000 Series Specifications

The specifications apply when the function generator is powered on for at least 30 minutes under +20°C~+30°C.

| AFG-2000 models           |                      | 2005  | 2012        | 2025        | 2105       | 2112        | 2125        |
|---------------------------|----------------------|---|-------------|-------------|------------|-------------|-------------|
| Waveforms                 |                      | Sine, Square, Ramp, Noise, ARB                  |             |             |            |             |             |
| Arbitrary Functions       |                      |   |             |             |            |             |             |
|                           | Sample Rate          | 20 MSa/s  |             |             |            |             |             |
|                           | Repetition Rate      | 10MHz   |             |             |            |             |             |
|                           | Waveform Length      | 4k points                                       |             |             |            |             |             |
|                           | Amplitude Resolution | 10 bits   |             |             |            |             |             |
|                           | Non-Volatile Memory  | 4k points                                       |             |             |            |             |             |
| Frequency Characteristics |                      |   |             |             |            |             |             |
| Range                     | Sine                 | 0.1Hz~5MHz                                      | 0.1Hz~12MHz | 0.1Hz~25MHz | 0.1Hz~5MHz | 0.1Hz~12MHz | 0.1Hz~25MHz |
|                           | Square               | 0.1Hz~5MHz                                      | 0.1Hz~12MHz | 0.1Hz~25MHz | 0.1Hz~5MHz | 0.1Hz~12MHz | 0.1Hz~25MHz |
|                           | Triangle, Ramp       | 1MHz  |             |             |            |             |             |
| Resolution                |                      | 0.1Hz   |             |             |            |             |             |
| Accuracy                  | Stability            | ±20 ppm   |             |             |            |             |             |
|                           | Aging                | ±1 ppm, per 1 year                              |             |             |            |             |             |
|                           | Tolerance            | ≤ 1 mHz   |             |             |            |             |             |
| Output Characteristics    |                      |   |             |             |            |             |             |
| Amplitude                 | Range                | 1 mVpp to 10 Vpp (into 50Ω)                     |             |             |            |             |             |
|                           |                      | 2 mVpp to 20 Vpp (open-circuit)                 |             |             |            |             |             |
|                           |                      | 1 mVpp to 5 Vpp (into 50Ω) for 20MHz-25MHz      |             |             |            |             |             |
|                           |                      | 2 mVpp to 10 Vpp (open-circuit) for 20MHz-25MHz |             |             |            |             |             |
|                           | Accuracy             | ± 2% of setting ±1 mVpp (at 1 kHz)              |             |             |            |             |             |
|                           | Resolution           | 1 mV or 3 digits                                |             |             |            |             |             |
|                           | Flatness             | ± 1% (0.1dB) ≤100kHz                            |             |             |            |             |             |
|                           |                      | ± 3% (0.3 dB) ≤5MHz                             |             |             |            |             |             |
|                           |                      | ± 5% (0.4 dB) ≤12MHz                            |             |             |            |             |             |
|                           |                      | ±20%(2dB)≤20MHz                                 |             |             |            |             |             |
|                           |                      | ± 5% (0.4 dB) ≤25MHz                            |             |             |            |             |             |
|                           |                      | (sine wave relative to 1 kHz)                   |             |             |            |             |             |
|                           | Units                | Vpp, Vrms, dBm                                  |             |             |            |             |             |

|                                    |                   |   |
|------------------------------------|-------------------|---|
| Offset                             | Range             | ±5 Vpk ac +dc (into 50Ω)<br>±10Vpk ac +dc (Open circuit)<br>±2.5 Vpk ac +dc (into 50Ω) for 20MHz-25MHz<br>±5Vpk ac +dc (Open circuit) for 20MHz-25MHz |
|                                    | Accuracy          | 2% of setting + 5 mV+ 0.5% of amplitude   |
| Waveform Output                    | Impedance         | 50Ω typical (fixed)<br>> 300kΩ (output disabled)  |
|                                    | Attenuator        | —   |
| SYNC Output                        | Protection        | Short-circuit protected<br>Overload relay automatically disables main output  |
|                                    | Level             | TTL-compatible into>1kΩ   |
|                                    | Impedance         | 50Ω nominal   |
|                                    | Fan Out           | —   |
|                                    | Rise of Fall Time | ≤ 25ns  |
| <b>Sine wave Characteristics</b>   |                   |   |
| Harmonic distortion                |                   | -55 dBc DC ~ 200kHz, Ampl > 0.1Vpp  |
|                                    |                   | -50 dBc 200kHz ~ 1MHz, Ampl > 0.1Vpp  |
|                                    |                   | -35 dBc 1MHz ~ 5MHz, Ampl > 0.1Vpp  |
|                                    |                   | -30 dBc 5MHz ~ 25MHz, Ampl > 0.1Vpp   |
| <b>Square wave Characteristics</b> |                   |   |
| Rise/Fall Time                     |                   | ≤25ns at maximum output.<br>(into 50 Ω load)  |
| Overshoot                          |                   | <5%   |
| Asymmetry                          |                   | 1% of period +1 ns  |
| Variable duty Cycle                |                   | 1.0% to 99.0% ≤100kHz<br>20.0% to 80.0% ≤ 5MHz<br>40.0% to 60.0% ≤ 10MHz<br>50% ≤ 25MHz   |
| <b>Ramp Characteristics</b>        |                   |   |
| Linearity                          |                   | < 0.1% of peak output   |
| Variable Symmetry                  |                   | 0% to 100% (0.1% Resolution)  |

| AM Modulation        |   |   |  |
|----------------------|---|---|--|
| Carrier Waveforms    | — | Sine, Square, Triangle                      |  |
| Modulating Waveforms | — | Sine, Square, Triangle                      |  |
| Modulating Frequency | — | 2mHz to 20kHz (Int)<br>DC to 20kHz (Ext)    |  |
| Depth                | — | 0% to 120.0%                                |  |
| Source               | — | Internal / External                         |  |
| FM Modulation        |   |   |  |
| Carrier Waveforms    | — | Sine, Square, Triangle                      |  |
| Modulating Waveforms | — | Sine, Square, Triangle                      |  |
| Modulating Frequency | — | 2mHz to 20kHz (Int)<br>DC to 20kHz (Ext)    |  |
| Peak Deviation       | — | DC to Max Frequency                         |  |
| Source               | — | Internal / External                         |  |
| Sweep                |   |   |  |
| Waveforms            | — | Sine, Square, Triangle                      |  |
| Type                 | — | Linear or Logarithmic                       |  |
| Start/Stop Freq      | — | 0.1Hz to Max Frequency                      |  |
| Sweep Time           | — | 1ms to 500s                                 |  |
| Source               | — | Internal / External                         |  |
| FSK                  |   |   |  |
| Carrier Waveforms    | — | Sine, Square, Triangle                      |  |
| Modulating Waveforms | — | 50% duty cycle square                       |  |
| Modulation Rate      | — | 2mHz to 100 kHz (INT)<br>DC to 100 kHz(EXT) |  |
| Frequency Range      | — | 0.1Hz to Max Frequency                      |  |
| Source               | — | Internal / External                         |  |

|                        |  |
|------------------------|--|
| Frequency Counter      |  |
| Range                  | — 5Hz to 150MHz  |
| Accuracy               | — Time Base accuracy±1 count   |
| Time Base              | — ±20ppm (23°C ±5°C) after 30 minutes warm up  |
| Resolution             | — The maximum resolution is: 100nHz for 1Hz, 0.1Hz for 100MHz.   |
| Input Impedance        | — 1kΩ/1pf  |
| Sensitivity            | — 35mVrms ~ 30Vms (5Hz to 150MHz)  |
| Save/Recall            | 10 Groups of Setting Memories (Locations 0~9 only for instrument state, Locations 10~19 only for ARB data)   |
| Interface              | USB (Device)   |
| Display                | LCD  |
| General Specifications |  |
| Power Source           | AC100~240V, 50~60Hz  |
| Power Consumption      | 25 VA (Max)  |
| Operating Environment  | Temperature to satisfy the specification : 18 ~ 28°C<br>Operating temperature : 0 ~ 40°C<br>Relative Humidity: ≤ 80%, 0 ~ 40°C<br>≤ 70%, 35 ~ 40°C<br>Installation category : CAT II |
| Operating Altitude     | 2000 Meters  |
| Storage Temperature    | -10~70°C, Humidity: ≤70%   |
| Dimensions (WxHxD)     | 266(W) x 107(H) x 293(D) mm  |
| Weight                 | Approx. 2.5kg  |
| Accessories            | GTL-101× 1      GTL-101× 2<br>Quick Start Guide x1<br>CD (user manual + software) x1<br>Power cordx1   |

## EC Declaration of Conformity

We

**GOOD WILL INSTRUMENT CO., LTD.**

No.7-1, Jhongsing Rd., Tucheng Dist., New Taipei City 236, Taiwan

**GOOD WILL INSTRUMENT (SUZHOU) CO., LTD.**

No. 69, Lushan Road, Suzhou New District Jiangsu, China

declares that the below mentioned product

**AFG-2005, AFG-2105, AFG-2012, AFG-2112, AFG-2025, AFG-2125**

Are herewith confirmed to comply with the requirements set out in the Council Directive on the Approximation of the Law of Member States relating to Electromagnetic Compatibility (2004/108/EC) and Low Voltage Equipment Directive (2006/95/EC). For the evaluation regarding the Electromagnetic Compatibility and Low Voltage Equipment Directive, the following standards were applied:

### © EMC

| EN 61326-1 :   | Electrical equipment for measurement, control and laboratory use — EMC requirements (2006) |  |
|--|--|--|
| Conducted and Radiated Emissions<br>EN 55011: 2009+A1:2010 | Electrostatic Discharge<br>EN 61000-4-2: 2008  |  |
| Current Harmonic<br>EN 61000-3-2: 2006+A2:2009             | Radiated Immunity<br>EN 61000-4-3: 2006+ A2:2010   |  |
| Voltage Fluctuation<br>EN 61000-3-3: 2008                  | Electrical Fast Transients<br>EN 61000-4-4: 2004+A1:2010                                   |  |
| -----  | Surge Immunity<br>EN 61000-4-5: 2005   |  |
| -----  | Conducted Susceptibility<br>EN 61000-4-6: 2008   |  |
| -----  | Power Frequency Magnetic Field<br>EN 61000-4-8: 2009                                       |  |
| -----  | Voltage Dips/ Interrupts<br>EN 61000-4-11: 2004  |  |

### © Safety

| Low Voltage Equipment Directive 2006/95/EC |
|--|
| Safety Requirements<br>EN 61010-1: 2010    |

# INDEX

|                                 |     |                                |        |
|---------------------------------|-----|--------------------------------|--------|
| Caution symbol .....            | 3   | AM Shape wave.....             | 46     |
| Cleaning the instrument.....    | 5   | Amplitude .....                | 37     |
| Declaration of conformity ..... | 141 | ARB .....                      | 73     |
| Default settings.....           | 32  | Duty.....                      | 39     |
| Digital inputs .....            | 19  | FM.....                        | 51     |
| Display                         |     | FM Carrier Amplitude .....     | 53     |
| diagram .....                   | 15  | FM Carrier Frequency .....     | 53     |
| Disposal                        |     | FM Carrier Wave .....          | 52     |
| symbol .....                    | 4   | FM Frequency Deviation .....   | 56     |
| Disposal instructions.....      | 6   | FM Modulation Source .....     | 57     |
| EN61010                         |     | FM Rate .....                  | 55     |
| measurement category .....      | 4   | FM Shape wave.....             | 55     |
| pollution degree .....          | 5   | Frequency .....                | 36     |
| Environment                     |     | Frequency Counter .....        | 75     |
| safety instructions .....       | 5   | FSK .....                      | 59     |
| Front panel diagram .....       | 10  | FSK Carrier Amplitude.....     | 62     |
| Function keys                   |     | FSK Carrier Frequency.....     | 61     |
| key overview .....              | 13  | FSK Carrier Wave .....         | 60     |
| Fuse                            |     | FSK Hop Frequency .....        | 63     |
| type .....                      | 5   | FSK Modulation Source .....    | 65     |
| Ground                          |     | FSK Rate.....                  | 64     |
| symbol .....                    | 3   | Gate Time.....                 | 76     |
| Interface                       |     | Offset.....                    | 38, 42 |
| Error messages .....            | 135 | Save/Recall ARB Waveform ..... | 81     |
| List of features .....          | 9   | Save/Recall State .....        | 81     |
| Modulation                      |     | Sine .....                     | 36     |
| AM .....                        | 43  | Sweep .....                    | 67     |
| FM.....                         | 51  | Sweep Mode.....                | 70     |
| FSK.....                        | 59  | Sweep Rate .....               | 70     |
| Operation                       |     | Sweep Start Frequency.....     | 68     |
| AM .....                        | 43  | Sweep Stop Frequency .....     | 68     |
| AM Carrier Amplitude.....       | 45  | Sweep Trigger Source.....      | 72     |
| AM Carrier Frequency.....       | 44  | Symmetry .....                 | 39     |
| AM Carrier Wave.....            | 44  | Operation menu.....            | 34     |
| AM Modulation Depth.....        | 48  | Output                         |        |
| AM Modulation frequency .....   | 47  | on/off.....                    | 42     |
| AM Modulation Source.....       | 49  | Power on/off                   |        |
| AM Rate.....                    | 47  | safety instruction .....       | 4      |
|                                 |     | Power up.....                  | 17     |



---

|                                |     |                                 |     |
|--------------------------------|-----|---------------------------------|-----|
| Quick reference .....          | 18  | Service operation               |     |
| Rear panel diagram .....       | 14  | about disassembly.....          | 4   |
| Remote Commands                |     | Setting up the instrument ..... | 16  |
| AM Commands .....              | 110 | software download .....         | 86  |
| Apply Commands .....           | 96  | Specifications .....            | 137 |
| ARB Commands .....             | 130 | SYNC Signal                     |     |
| FM Commands .....              | 114 | AM.....                         | 79  |
| Frequency Counter Commands     | 128 | ARB.....                        | 78  |
| FSK Commands .....             | 119 | FM.....                         | 79  |
| Output Commands .....          | 102 | FSK.....                        | 80  |
| Save/Recall Commands .....     | 133 | Ramp .....                      | 78  |
| Status Register Commands ..... | 95  | Sine .....                      | 77  |
| Sweep Commands.....            | 123 | Square.....                     | 78  |
| System Commands.....           | 94  | Sweep .....                     | 80  |
| Remote interface .....         | 83  | UK power cord.....              | 7   |
| functionality check .....      | 86  | USB                             |     |
| Syntax.....                    | 86  | remote control interface .....  | 85  |
| terminal connection.....       | 85  | Warning symbol.....             | 3   |
| USB Connection.....            | 85  |                                 |     |