

# Arbitrary Function Generator

AFG-2000 Series

---

## QUICK START GUIDE

GW INSTEK PART NO. 82AF-21200MC1



ISO-9001 CERTIFIED MANUFACTURER

**GW INSTEK**

This manual contains proprietary information, which is protected by copyright. All rights are reserved. No part of this manual may be photocopied, reproduced or translated to another language without prior written consent of Good Will Corporation.

The information in this manual was correct at the time of printing. However, Good Will continues to improve its products and therefore reserves the right to change the specifications, equipment, and maintenance procedures at any time without notice.

**Good Will Instrument Co., Ltd.**  
**No. 7-1, Jhongsing Rd., Tucheng Dist., New Taipei City 236, Taiwan.**

# Table of Contents

<b>SAFETY INSTRUCTIONS</b> .....	<b>2</b>
<b>GETTING STARTED</b> .....	<b>6</b>
Main Features .....	6
Panel Overview.....	8
Selecting a Waveform .....	14
ARB.....	15
Modulation.....	15
Sweep (2100 series only) .....	17
Counter (2100 series only) .....	17
Save/Recall.....	18
AFG-2000 Series Specifications .....	19
EC Declaration of Conformity .....	23

# S SAFETY INSTRUCTIONS

This chapter contains important safety instructions that should be followed when operating and storing the function generator. Read the following before any operation to ensure your safety and to keep the function generator in the best condition.

## Safety Symbols

These safety symbols may appear in this manual or on the instrument.

---



Warning: Identifies conditions or practices that could result in injury or loss of life.



Caution: Identifies conditions or practices that could result in damage to the function generator or to other objects or property.



**DANGER** High Voltage



Attention: Refer to the Manual



Protective Conductor Terminal



Earth (Ground) Terminal



**DANGER** Hot Surface



Double Insulated



Do not dispose electronic equipment as unsorted municipal waste. Please use a separate collection facility or contact the supplier from which this instrument was purchased.

## Safety Guidelines

---

### General Guideline



#### CAUTION

- Do not place heavy objects on the instrument.
- Do not place flammable objects on the instrument.
- Avoid severe impact or rough handling that may damage the function generator.
- Avoid discharges of static electricity on or near the function generator.
- Use only mating connectors, not bare wires, for the terminals.
- The instrument should only be disassembled by a qualified technician.

(Measurement categories) EN 61010-1:2010 specifies the measurement categories and their requirements as follows. The instrument falls under category II.

- Measurement category IV is for measurement performed at the source of a low-voltage installation.
- Measurement category III is for measurement performed in a building installation.
- Measurement category II is for measurement performed on circuits directly connected to a low voltage installation.
- Measurement category I is for measurements performed on circuits not directly connected to Mains.

---

### Power Supply



#### WARNING

- AC Input voltage: 100 ~ 240V AC, 50 ~ 60Hz.
  - Connect the protective grounding conductor of the AC power cord to an earth ground to prevent electric shock.
-

Fuse



**WARNING**

- Fuse type: F1A/250V.
- Only qualified technicians should replace the fuse.
- To ensure fire protection, replace the fuse only with the specified type and rating.
- Disconnect the power cord and all test leads before replacing the fuse.
- Make sure the cause of fuse blowout is fixed before replacing the fuse.

Cleaning the function generator

- Disconnect the power cord before cleaning the function generator.
- Use a soft cloth dampened in a solution of mild detergent and water. Do not spray any liquid into the function generator.
- Do not use chemicals containing harsh products such as benzene, toluene, xylene, and acetone.

Operation Environment

- Location: Indoor, no direct sunlight, dust free, almost non-conductive pollution (Note below) and avoid strong magnetic fields.
- Relative Humidity: < 80%
- Altitude: < 2000m
- Temperature: 0°C to 40°C

(Pollution Degree) EN 61010-1:2010 specifies pollution degrees and their requirements as follows. The function generator falls under degree 2.

Pollution refers to “addition of foreign matter, solid, liquid, or gaseous (ionized gases), that may produce a reduction of dielectric strength or surface resistivity”.

- Pollution degree 1: No pollution or only dry, non-conductive pollution occurs. The pollution has no influence.
- Pollution degree 2: Normally only non-conductive pollution occurs. Occasionally, however, a temporary conductivity caused by condensation must be expected.
- Pollution degree 3: Conductive pollution occurs, or dry, non-conductive pollution occurs which becomes conductive due to condensation which is expected. In such conditions, equipment is normally protected against exposure to direct sunlight,

precipitation, and full wind pressure, but neither temperature nor humidity is controlled.

Storage environment

- Location: Indoor
- Relative Humidity: < 70%
- Temperature: -10°C to 70°C

Disposal



Do not dispose this instrument as unsorted municipal waste. Please use a separate collection facility or contact the supplier from which this instrument was purchased. Please make sure discarded electrical waste is properly recycled to reduce environmental impact.

## Power cord for the United Kingdom

When using the function generator in the United Kingdom, make sure the power cord meets the following safety instructions.

**NOTE:** This lead/appliance must only be wired by competent persons



**WARNING: THIS APPLIANCE MUST BE EARTHED**

**IMPORTANT:** The wires in this lead are coloured in accordance with the following code:

Green/ Yellow:

Earth

Blue:

Neutral

Brown:

Live (Phase)



As the colours of the wires in main leads may not correspond with the coloured marking identified in your plug/appliance, proceed as follows:

The wire which is coloured Green & Yellow must be connected to the Earth terminal marked with either the letter E, the earth symbol ⊕ or coloured Green/Green & Yellow.

The wire which is coloured Blue must be connected to the terminal which is marked with the letter N or coloured Blue or Black.

The wire which is coloured Brown must be connected to the terminal marked with the letter L or P or coloured Brown or Red.

If in doubt, consult the instructions provided with the equipment or contact the supplier.

This cable/appliance should be protected by a suitably rated and approved HBC mains fuse: refer to the rating information on the equipment and/or user instructions for details. As a guide, a cable of 0.75mm<sup>2</sup> should be protected by a 3A or 5A fuse. Larger conductors would normally require 13A types, depending on the connection method used.

Any exposed wiring from a cable, plug or connection that is engaged in a live socket is extremely hazardous. If a cable or plug is deemed hazardous, turn off the mains power and remove the cable, any fuses and fuse assemblies. All hazardous wiring must be immediately destroyed and replaced in accordance to the above standard.

# G E T T I N G S T A R T E D

The Getting started chapter introduces the function generator’s main features, appearance and introduces a quick instructional summary of some of the basic functions. For comprehensive operation instructions, please see the user manual.

## Main Features

Model name	AFG-2005	AFG-2105	AFG-2012	AFG-2112	AFG-2025	AFG-2125
Frequency Range	0.1Hz~5MHz		0.1Hz~12MHz		0.1Hz~25MHz	
Output waveform	Sine, Square, Ramp, Noise, ARB					
Amplitude range	0.1Hz~20MHz					
	1 mVpp to 10 Vpp( into 50Ω) 2 mVpp to 20 Vpp(open-circuit)					
	20MHz~25MHz					
	1 mVpp to 5 Vpp( into 50Ω) 2 mVpp to 10 Vpp(open-circuit)					
Variable Offset	✓	✓	✓	✓	✓	✓
Variable Duty	✓	✓	✓	✓	✓	✓
SYNC (TTL) output	✓	✓	✓	✓	✓	✓
Save/Recall	✓	✓	✓	✓	✓	✓
Sweep operation	—	✓	—	✓	—	✓
AM	—	✓	—	✓	—	✓
FM	—	✓	—	✓	—	✓
FSK	—	✓	—	✓	—	✓
Frequency Counter	—	✓	—	✓	—	✓



---

ARB	✓	✓	✓	✓	✓	✓
USB Interface	✓	✓	✓	✓	✓	✓

---

- Performance
- DDS technology using an FPGA provides high resolution waveforms
  - 25MHz DDS (Direct Digital Synthesis) signal output series
  - 0.1Hz resolution
  - Full Function Arbitrary Waveform Capability
    - 20 MSa/s sample rate
    - 10 MHz repetition rate
    - 4 k-point waveform length
    - 10-bit amplitude resolution
    - Ten 4k waveform memories
- 

- Features
- Sine, Square, Ramp, Noise
  - Int/Ext AM, FM, FSK modulation
  - Modulation/sweep signal output
  - Save/recall 10 groups of setting memories
  - Output overload protection
  - ARB (Arbitrary Waveform) can be edited with PC software
- 

- Interface
- USB interface as standard
  - 3.5 inch LCD





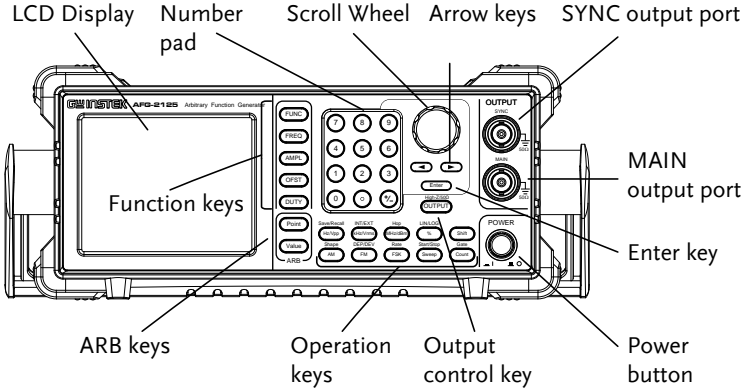

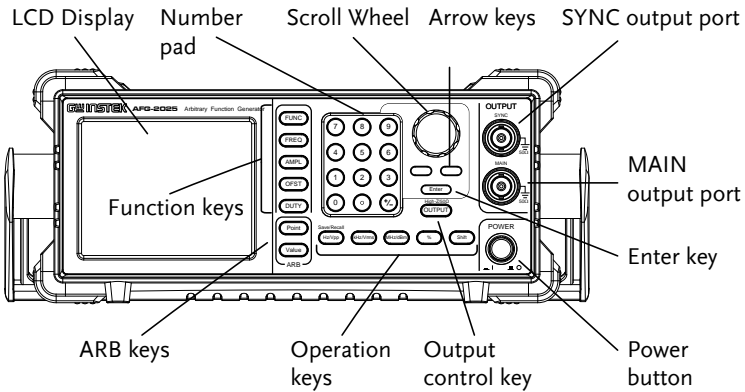

## Panel Overview

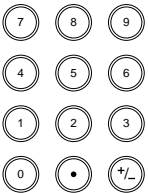

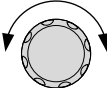

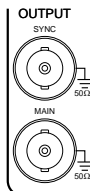



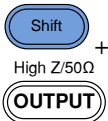













### AFG-2105/2112/2125 Front Panel



### AFG-2005/2012/2025 Front Panel



LCD display	3.5 inch, 3 color LCD display.
Keypad	 <p>The digital keypad is used to enter values and parameters. The keypad is often used in conjunction with the selection keys and variable knob.</p>
Scroll Wheel	 <p>The scroll wheel is used to edit values and parameters in steps of 1 digit. Used in conjunction with the arrow keys.</p> <div style="text-align: center;">  <p>Decrease      Increase</p> </div>
Arrow keys	 <p>Used to select digits when editing parameters.</p>
Output ports	 <p>SYNC output port (50Ω impedance). Main output port (50Ω impedance).</p>
Enter key	 <p>Used to confirm input values.</p>
Power button	 <p>Turns the instrument power on/off.</p>
Output control key	 <p>Turns the output on/off.</p>
Output Impedance	 <p>Toggles the output impedance between 50Ω and High-Z.</p>

Operation keys		Selects Hz or Vpp units.
	 + 	Saves or recalls waveforms from memory.
		Selects kHz or Vrms units.
	 + 	Sets the source to internal or external for the modulation and FSK functions*.
		Selects MHz or dBm units.
	 + 	Sets the "Hop" frequency for FSK modulation*.
		Selects % units.
	 + 	Sets the sweep to linear or logarithmic*.
		The shift key is used to select the secondary functions on the operation keys.
		The AM key is used to turn AM modulation on/off*.
	 + 	Selects the modulation waveform*.
		The FM key is used to turn FM modulation on/off*.
	 + 	Selects the modulation depth or the frequency deviation*.
		Selects FSK modulation*.
	 + 	Sets the AM, FM, FSK modulation and sweep function (Rate)*



Selects the Sweep function\*.

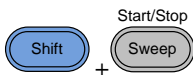

Sets the Start or Stop frequency\*.



Turns the frequency counter on/off\*.

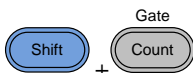

Sets the frequency counter gate time\*.

ARB edit keys

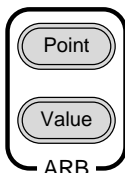

Arbitrary waveform editing keys.

The point key sets the ARB point numbers.

The Value key sets the amplitude value of the selected point.

Function keys



The FUNC key is used to select the output waveform type, Sine, Square, Ramp, Noise, ARB.



Sets the frequency of the selected waveform.



Sets the amplitude of the selected waveform.



The OFST sets the DC offset for the selected waveform.



The DUTY key sets the duty cycle of square and ramp waveforms.



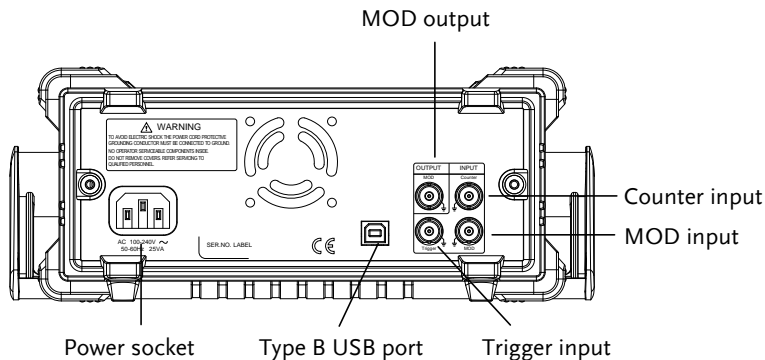

\*indicates functions/features for the AFG-2105/2112/2125 only.

### AFG-2105/2112/2125 Rear Panel

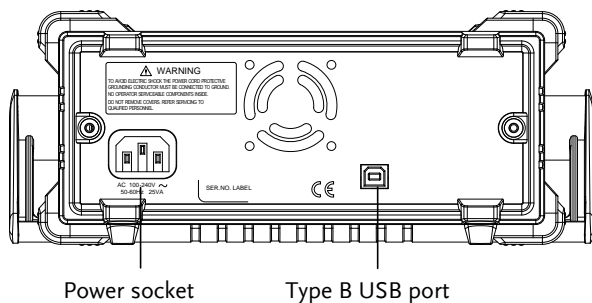

### AFG-2005/2012/2025 Rear Panel

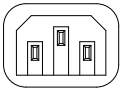

MOD output		Modulation output port.
Counter input		Counter input port.
MOD input		Modulation input port.
Trigger input		Trigger input port.
Type B USB port		The type B USB port is used to connect the function generator to a PC for remote control.
Power Socket Input	 AC 100-240V ~ 50-60Hz 25VA	Power input: 100~240V AC 50~60Hz.

Display

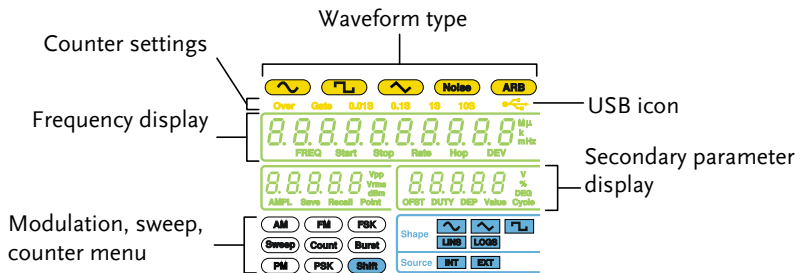

Waveform type    **Noise** **ARB**

Press the function key to cycle through different output waveforms.

Counter settings **Over** **Gate** **0.01S** **0.1S** **1S** **10S**

Gate time counter settings\*.

USB icon  Shows the USB interface status.

Frequency Display 

Displays the main waveform frequency settings.

Secondary parameter display 

Displays secondary waveform parameters and settings.

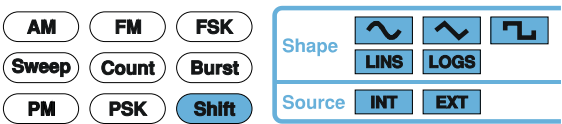
Modulation, sweep, counter menu 

Displays the modulation, sweep and counter functions as well as the modulating waveform and source\*.

\*indicates functions/features for the AFG-2105/2112/2125 only.

## Selecting a Waveform

### Sine Wave

---

Example: Sine Wave, 10kHz, 1Vpp, 2Vdc

Output

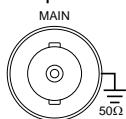

1. Press **FUNC**>select the sine wave
2. Press **FREQ**>1>0>kHz
3. Press **AMPL**>1>Vpp
4. Press **OFST**>2>Vpp
5. Press **OUTPUT**

### Square Wave

---

Example: Square Wave, 10kHz, 3Vpp, 75% duty cycle

Output

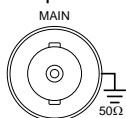

1. Press **FUNC**>select the square wave
2. Press **FREQ**>1>0>kHz
3. Press **AMPL**>3>Vpp
4. Press **DUTY**>7>5>%
5. Press **OUTPUT**

### Ramp Wave

---

Example: Ramp Wave, 10kHz, 3Vpp, 25% symmetry

Output

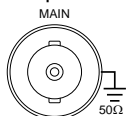

1. Press **FUNC**>select the ramp wave
2. Press **FREQ**>1>0>kHz
3. Press **AMPL**>3>Vpp
4. Press **DUTY**>2>5>%
5. Press **OUTPUT**



## ARB

### ARB – Enter Points

---

Example: ARB Ramp, 10 kHz, 1Vpp, 2 points.

Output

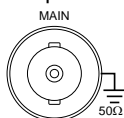

1. Press **FUNC**>select the ARB wave
2. Press **FREQ**>1>0>kHz
3. Press **AMPL**>1>Vpp
4. Press **Point**>0>Enter
5. Press **Value**>5>1>1>Enter. (+511 amplitude)
6. Press **Point**>1>Enter
7. Press **Value**>+/->5>1>1>Enter. (-511 amplitude)
8. Press **OUTPUT**

## Modulation

### AM (2100 series only)

---

Example: AM modulation. 100Hz modulating square wave. 1 Vpp, 1kHz Sine wave carrier. 70% modulation depth. Internal source signal.

Output

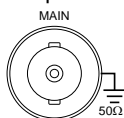

1. Press **FUNC**>select the sine wave
2. Press **FREQ**>1>kHz
3. Press **AMPL**>1>Vpp
4. Press **AM**
5. Press **Shift**>INT/EXT>select INT source
6. Press **Shift**>Shape>select the square wave
7. Press **Shift**>Rate>1>0>0>Hz
8. Press **Shift**>DEP/DEV>7>0>%
9. Press **Output**
10. Press **AM** to deselect the AM function

## FM (2100 series only)

---

Example: FM modulation. 100Hz modulating square wave. 1Vpp, 1kHz Sine wave carrier. 100 Hz frequency deviation. Internal Source.

### Output

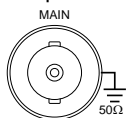

1. Press **FUNC**>select the sine wave
2. Press **FREQ**>1>kHz
3. Press **AMPL**>1>Vpp
4. Press **FM**
5. Press **Shift**>INT/EXT>select INT
6. Press **Shift**>Shape>select square
7. Press **Shift**>Rate>1>0>0>Hz
8. Press **Shift**>DEP/DEV>1>0>0>Hz
9. Press **Output**
10. Press **FM** to deselect the FM function

## FSK Modulation (2100 series only)

---

Example: FSK modulation. 100Hz Hop frequency. 1Vpp, 1kHz Ramp carrier wave. 10 Hz Rate (modulation frequency). Internal Source.

### Output

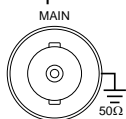

1. Press **FUNC**>select the ramp wave
2. Press **FREQ**>1>kHz
3. Press **AMPL**>1>Vpp
4. Press **FSK**
5. Press **Shift**>INT/EXT>Select INT
6. Press **Shift**>Rate>1>0>Hz
7. Press **Shift**>HOP>1>0>0>Hz
8. Press **Output**
9. Press **FSK** to deselect the FSK function

## Sweep (2100 series only)

Example: Frequency Sweep. Start Frequency 1Hz, Stop Frequency 1MHz. 1Hz Rate. 1Vpp. Lins Sweep.

Output

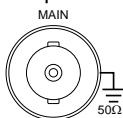

1. Press **FUNC**>select the ramp wave
2. Press **AMPL**>1>Vpp
3. Press **Sweep**
4. Press **Shift**>INT/EXT>select INT
5. Press **Shift**>Start/Stop>select Start>1>Hz
6. Press **Shift**>Start/Stop>select Stop>1>MHz
7. Press **Shift**>Rate>1>Hz
8. Press **Shift**>LIN/LOG>Select LINS
9. Press **Output**
10. Press **Sweep** to deselect the sweep function

## Counter (2100 series only)

Example: Frequency counter function, gate time 1s.

Input

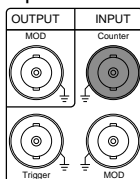

1. Press **Count**
2. Press **Shift**>Gate>select 1S gate time
3. Connect the signal to the counter input terminal.
4. Press **Count** to deselect the counter function.

## Save/Recall

### Save

---

Example: Save waveform to memory.

1. Press **Shift>Save/Recall>Select Save**
2. Turn the **Scroll knob>select a file number>Enter**

### Recall

---

Example: Recall waveform from memory.

1. Press **Shift>Save/Recall>Select Recall**
2. Turn the **Scroll knob>select a file number>Enter**

## AFG-2000 Series Specifications

The specifications apply when the function generator is powered on for at least 30 minutes under +20°C~+30°C.

AFG-2000 models		2005	2012	2025	2105	2112	2125
Waveforms		Sine, Square, Ramp, Noise, ARB					
Arbitrary Functions							
	Sample Rate	20 MSa/s					
	Repetition Rate	10MHz					
	Waveform Length	4k points					
	Amplitude Resolution	10 bits					
	Non-Volatile Memory	4k points					
Frequency Characteristics							
Range	Sine	0.1Hz~5MHz	0.1Hz~12MHz	0.1Hz~25MHz	0.1Hz~5MHz	0.1Hz~12MHz	0.1Hz~25MHz
	Square	0.1Hz~5MHz	0.1Hz~12MHz	0.1Hz~25MHz	0.1Hz~5MHz	0.1Hz~12MHz	0.1Hz~25MHz
	Triangle, Ramp	1MHz					
Resolution		0.1Hz					
Accuracy	Stability	±20 ppm					
	Aging	±1 ppm, per 1 year					
	Tolerance	≤ 1 mHz					
Output Characteristics							
Amplitude	Range	1 mVpp to 10 Vpp( into 50Ω)					
		2 mVpp to 20 Vpp(open-circuit)					
		1 mVpp to 5 Vpp( into 50Ω) for 20MHz-25MHz					
		2 mVpp to 10 Vpp(open-circuit) for 20MHz-25MHz					
	Accuracy	± 2% of setting ±1 mVpp (at 1 kHz)					
	Resolution	1 mV or 3 digits					
	Flatness	± 1% (0.1dB) ≤100kHz					
		± 3% (0.3 dB) ≤5MHz					
		± 5% (0.4 dB) ≤12MHz					
		±20%(2dB)≤20MHz					
		± 5% (0.4 dB) ≤25MHz					
		(sine wave relative to 1 kHz)					
	Units	Vpp, Vrms, dBm					

Offset	Range	±5 Vpk ac +dc (into 50Ω) ±10Vpk ac +dc (Open circuit) ±2.5 Vpk ac +dc (into 50Ω) for 20MHz-25MHz ±5Vpk ac +dc (Open circuit) for 20MHz-25MHz
	Accuracy	2% of setting + 5 mV+ 0.5% of amplitude
Waveform Output	Impedance	50Ω typical (fixed) > 300kΩ (output disabled)
	Attenuator	—
SYNC Output	Protection	Short-circuit protected Overload relay automatically disables main output
	Level	TTL-compatible into>1kΩ
	Impedance	50Ω nominal
	Fan Out	—
	Rise of Fall Time	≤ 25ns
<b>Sine wave Characteristics</b>		
Harmonic distortion(5)	-55 dBc	DC ~ 200kHz, Ampl > 0.1Vpp
	-50 dBc	200kHz ~ 1MHz, Ampl > 0.1Vpp
	-35 dBc	1MHz ~ 5MHz, Ampl > 0.1Vpp
	-30 dBc	5MHz ~ 25MHz, Ampl > 0.1Vpp
<b>Square wave Characteristics</b>		
Rise/Fall Time	≤25ns at maximum output. (into 50 Ω load)	
Overshoot	<5%	
Asymmetry	1% of period +1 ns	
Variable duty Cycle	1.0% to 99.0% ≤100kHz 20.0% to 80.0% ≤ 5MHz 40.0% to 60.0% ≤ 10MHz 50% ≤ 25MHz	
<b>Ramp Characteristics</b>		
Linearity	< 0.1% of peak output	
Variable Symmetry	0% to 100% (0.1% Resolution)	

<b>AM Modulation</b>			
	Carrier Waveforms	—	Sine, Square, Triangle
	Modulating Waveforms	—	Sine, Square, Triangle
	Modulating Frequency	—	2mHz to 20kHz (Int) DC to 20kHz (Ext)
	Depth	—	0% to 120.0%
	Source	—	Internal / External
<b>FM Modulation</b>			
	Carrier Waveforms	—	Sine, Square, Triangle
	Modulating Waveforms	—	Sine, Square, Triangle
	Modulating Frequency	—	2mHz to 20kHz (Int) DC to 20kHz (Ext)
	Peak Deviation	—	DC to Max Frequency
	Source	—	Internal / External
<b>Sweep</b>			
	Waveforms	—	Sine, Square, Triangle
	Type	—	Linear or Logarithmic
	Start/Stop Freq	—	0.1Hz to Max Frequency
	Sweep Time	—	1ms to 500s
	Source	—	Internal / External
<b>FSK</b>			
	Carrier Waveforms	—	Sine, Square, Triangle
	Modulating Waveforms	—	50% duty cycle square
	Modulation Rate	—	2mHz to 100kHz (INT) DC to 100kHz (Ext)
	Frequency Range	—	0.1Hz to Max Frequency
	Source	—	Internal / External

<b>Frequency Counter</b>	
Range	— 5Hz to 150MHz
Accuracy	— Time Base accuracy±1 count
Time Base	— ±20ppm (23°C ±5°C) after 30 minutes warm up
Resolution	— The maximum resolution is: 100nHz for 1Hz, 0.1Hz for 100MHz.
Input Impedance	— 1kΩ/1pf
Sensitivity	— 35mVrms ~ 30Vms (5Hz to 150MHz)
Save/Recall	10 Groups of Setting Memories (Locations 0~9 only for instrument state, Locations 10~19 only for ARB data)
Interface	USB (Device)
Display	LCD
<b>General Specifications</b>	
Power Source	AC100~240V, 50~60Hz
Power Consumption	25 VA (Max)
Operating Environment	Temperature to satisfy the specification : 18 ~ 28°C Operating temperature : 0 ~ 40°C Relative Humidity: ≤ 80%, 0 ~ 40°C ≤ 70%, 35 ~ 40°C Installation category : CAT II
Operating Altitude	2000 Meters
Storage Temperature	-10~70°C, Humidity: ≤70%
Dimensions (WxHxD)	266(W) x 107(H) x 293(D) mm
Weight	Approx. 2.5kg
Accessories	GTL-101× 1      GTL-101× 2 Quick Start Guide ×1 CD (user manual + software) ×1 Power cord×1



## EC Declaration of Conformity

We

**GOOD WILL INSTRUMENT CO., LTD.**

No.7-1, Jhongsing Rd., Tucheng Dist., New Taipei City 236, Taiwan

**GOOD WILL INSTRUMENT (SUZHOU) CO., LTD.**

No. 69, Lushan Road, Suzhou New District Jiangsu, China

declares that the below mentioned product

**AFG-2005, AFG-2105, AFG-2012, AFG-2112, AFG-2025, AFG-2125**

Are herewith confirmed to comply with the requirements set out in the Council Directive on the Approximation of the Law of Member States relating to Electromagnetic Compatibility (2004/108/EC) and Low Voltage Equipment Directive (2006/95/EC). For the evaluation regarding the Electromagnetic Compatibility and Low Voltage Equipment Directive, the following standards were applied:

© **EMC**

EN 61326-1 :	Electrical equipment for measurement, control and laboratory use — EMC requirements (2006)	
Conducted and Radiated Emissions EN 55011: 2009+A1:2010	Electrostatic Discharge EN 61000-4-2: 2008	
Current Harmonic EN 61000-3-2: 2006+A2:2009	Radiated Immunity EN 61000-4-3: 2006+ A2:2010	
Voltage Fluctuation EN 61000-3-3: 2008	Electrical Fast Transients EN 61000-4-4: 2004+A1:2010	
-----	Surge Immunity EN 61000-4-5: 2005	
-----	Conducted Susceptibility EN 61000-4-6: 2008	
-----	Power Frequency Magnetic Field EN 61000-4-8: 2009	
-----	Voltage Dips/ Interrupts EN 61000-4-11: 2004	

© **Safety**

Low Voltage Equipment Directive 2006/95/EC
Safety Requirements EN 61010-1: 2010