

## Instruction Manual FK

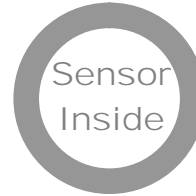

Thank you for buying a SAUTER force gauge. We hope you are pleased with your high quality force gauge with its big functional range. If you have any queries, wishes or helpful suggestions, do not hesitate to call our service number.

„Sensor Inside“ means the measuring cell is inside the housing.

### 1. Included in delivery

- SAUTER FK
- Charger
- Standard Attachments as shown below

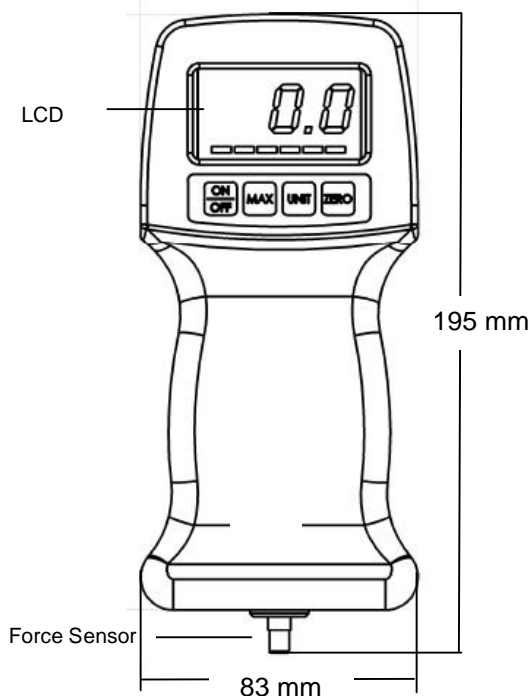

Terms:

- Track = continuous measurement
- Peak = Capture of the maximum value

Data in mm

### 2. Working Conditions

10°C to 30°C / 15% up to 80% humidity

### 3. Electrical Power Supply

Either by rechargeable battery or current power supply

Current power supply:

- Connection by power adapter
- Rechargeable batteries are charged simultaneously

Rechargeable battery pack for mobile applications:

- Type: AA Size 6 Batteries
- Charging time: approx 1 hour

### 4. Technical Data

- Accuracy:  $\pm 0,5$  % of Capacity
- Data Sampling Rate: 1.000 Hz

Model	Capacity	Resolution
FK 10	10 N	0,005 N
FK 25	20 N	0,010 N
FK 50	50 N	0,020 N
FK 100	100 N	0,050 N
FK 250	200 N	0,100 N
FK 500	500 N	0,20 N
FK 1k	1 000 N	0,50 N

## Instruction Manual FK

### 5. Operation

#### a. Display

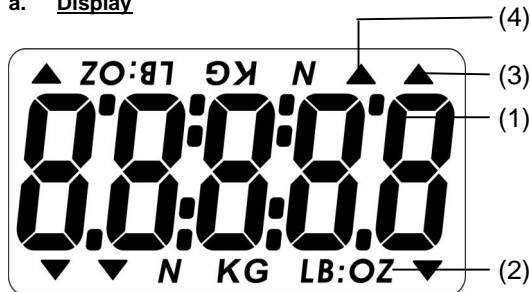

- (1) Measuring Result
- (2) Measuring Units
- (3) Measuring Direction
- (4) Indication of PEAK Mode

#### b. Operating keys

ON / OFF:   
ON / OFF key  
(For ON, press 1 sec.)

MAX:

Changes between Track and Peak mode (capture of maximum values)

UNIT:   
- Press short: Select unit:  
N, kg, lb, ou

ZERO:   
- Zeros the measuring result (Tara function)  
- Cleans the peak value (in Peak mode)

#### c. Display Return

When the instrument itself is turned so that the head faces down, the display returns automatically.

#### d. Measurement (Track Modus)

Display (1) shows the continuous force in a defined direction (3)

To zero the display, press:



#### e. Peak-Hold Function (Peak Mode)

Please press:



#### 6. Backside Fixing to a test stand

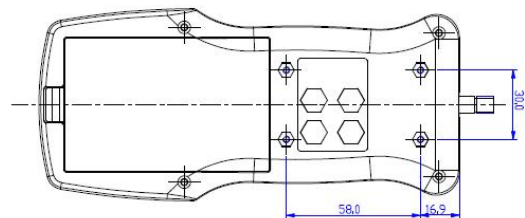

Fixing by 4 x M3 screws.

### 7. CE Declaration of Conformity



SAUTER GmbH  
D-72458 Albstadt  
E-Mail: info@sauter.eu

Tel: 0049-07431-938-666  
Fax: 0049-07431-938-292  
Internet: www.sauter.eu

#### Konformitätserklärung

Declaration of conformity for apparatus with CE mark  
Konformitätserklärung für Geräte mit CE-Zeichen  
Déclaration de conformité pour appareils portant la marque CE  
Declaración de conformidad para aparatos con marca CE  
Dichiarazione di conformità per apparecchi contrassegnati con la marcatura CE

English We hereby declare that the product to which this declaration refers conforms with the following standards.  
Deutsch Wir erklären hiermit, dass das Produkt, auf das sich diese Erklärung bezieht, mit den nachstehenden Normen übereinstimmt.  
Français Nous déclarons avec cela responsabilité que le produit, auquel se rapporte la présente déclaration, est conforme aux normes citées ci-après.  
Español Manifestamos en la presente que el producto al que se refiere esta declaración está en acuerdo con las normas siguientes  
Italiano Dichiariamo con ciò che il prodotto al quale la presente dichiarazione si riferisce è conforme alle norme di seguito citate.

#### Digital Push Pull Gauge: SAUTER FK

Mark applied	EU Directive	Standards
	89/336/EEC EMC	EN 61326 : 1998 +A1:1998 +A2:2001

Date: 01.1.2008

Signature:   
SAUTER GmbH  
Management

SAUTER GmbH, Schumannstrasse 33, D-72458 Albstadt, Tel: +49 (0) 7431 938 666, Fax: +49 (0) 7431 938 292

## Instruction Manual FK

### 8. Warning

#### 2.1 Intended use

The instrument you have acquired serves to determine the measuring value of the material to be measured. It is intended to be used as a "non-automatic" instrument, i.e. the material to be measured is manually and carefully attached at the instrument. The measuring value can be read off after a stable measuring value has been obtained.

#### 2.2 Inappropriate use

Do not use the instrument for dynamic measuring. In the event that small quantities are removed or added to the material to be measured, incorrect measuring results can be displayed due to the "stability compensation" in the instrument. (Example: Slow draining off of liquid from a container suspended from the instrument). Do not attach a continuous load. This can damage the measuring unit as well as the parts, relevant to safety.

Prevent jolts, torsion and oscillation (e.g. by appending slopingly) of all kinds. Be sure to prevent overloading the instrument in excess of the stated maximum load (max.), minus any tare weight that may possibly exist. This could damage the instrument (risk of breakage).

Important:

- Always make sure that there are no people or materials below the load that could be injured or damaged!
- The instrument is not suitable for measuring people. Do not use as baby scales!
- The instrument does not comply with the medical product law (MPG).

Never operate the instrument in hazardous locations. The series design is not explosion-proof. Structural alterations may not be made to the instrument. This can lead to incorrect measuring results, faults concerning safety regulations as well as to destruction of the instrument. The instrument may only be used in compliance with the described guidelines. Varying areas of application/

planned use must be approved by SAUTER in writing.

#### 2.3 Guarantee

The guarantee is not valid following

- non-observation of our guidelines in the operating instructions

- use outside the described applications
- alteration to or opening of the device
- mechanical damage and damage caused by media, liquids
- natural wear and tear
- inappropriate erection or electric installation
- overloading of the measuring equipment

#### 2.4 Monitoring the test substances

The metrology features of the instrument and any possible available adjusting weight must be checked at regular intervals within the scope of quality assurance. For this purpose, the answerable user must define a suitable interval as well as the nature and scope of this check. Information is available on the home page ([www.KERN-sohn.com](http://www.KERN-sohn.com)) with regard to the monitoring of instrument test substances and the test weights required for this. Test weights and instruments can be adjusted quickly and at a reasonable price in KERN's accredited DKD calibration laboratory (return to national normal).

#### 3. Fundamental safety information

Do not use the hanging instrument to transport loads. Prevent jolts, torsion and oscillation (e.g. by appending slopingly) of all kinds.

Never use the hanging instrument over the maximum permitted weight (!!Danger of breaking!!).

Always make sure that there are no living beings or materials below the load that could be injured or damaged. The hanging electronic instruments from the SAUTER instrument are only suitable for hand-held use or use in a test stand.

They are not suitable for hanging from a mechanical hook, e.g. a crane hook.

3.1 Observe the information in the operating instructions. Please read the operating instructions carefully before erecting

and commissioning, even if you already have experience with SAUTER instruments.

#### 3.2 Staff training

The device may only be operated and looked after by trained members of staff.

