

# BENNING

## CM7 Electrical Tester

### Service Information

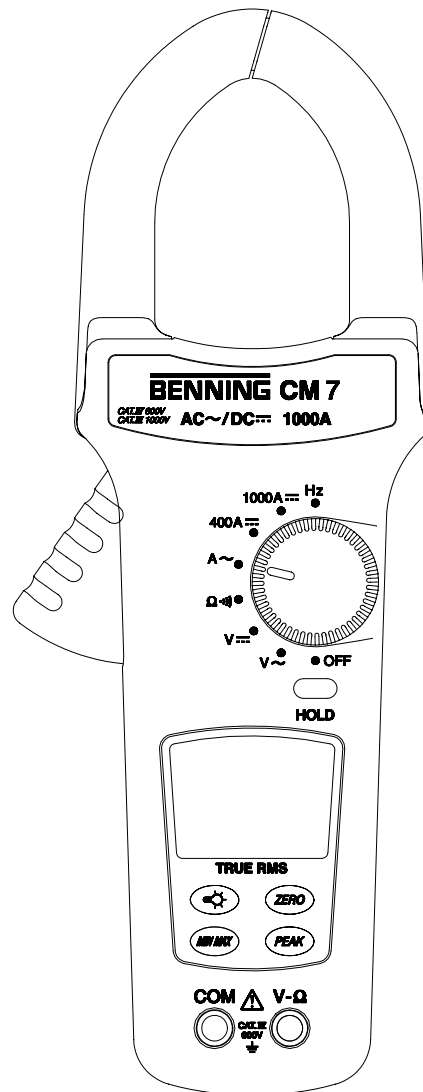

<b>TABLE OF CONTENTS</b>	<b>Page</b>
Introduction	1
Precautions and Safety Information	1
Symbols	1
Safety	2
Specifications	3
General Specification	3
Voltage Specification	4
Resistance & Continuity Specification	4
Current Specification	5
Frequency Specification	5
Physical and environment characteristics	7
Certification and compliance	7
Required Equipment	8
Basic Maintenance	9
Opening the Meter Case	9
Replacing the Battery	9
Performance Tests	10
Testing the Voltage Function	10
Testing the Resistance Function	11
Testing the AC Current Function	12
Testing the DC Current Function	12
Testing the Hz Function	13
Calibration	14
Calibrating DCV, ACV, ACA Functions	14

## Introduction

### Warning

To avoid shock or injury, do not perform the verification tests or calibration procedures described in the manual unless you are qualified to do so.

The information provided in this document is for the use of qualified personnel only.

### Caution

The CM7 contain parts that can be damaged by static discharge.

Follow the standard practices for handling static sensitive devices.

*For additional information about BENNING GMBH & CO. KG. and its products, and services, visit BENNING GMBH & CO. KG. web site at:*

[www.benning.de](http://www.benning.de)

## Precautions and Safety Information

Use the Meter only as described in the Service Manual. If you do not do so, the protection provided by the Meter may be impaired. Read the "Safety Information" page before servicing this product.









In this manual, a **Warning** identifies conditions and actions that pose hazard (s) to the user; a

**Caution** identifies conditions and actions that may damage the Meter or the test instruments.

## The Symbols

The symbols used on the Meter and in this manual are explained in Table 1.

Table A. The Symbols

	Risk of electric shock
	See instruction card
	DC measurement
	Equipment protected by double or reinforced insulation
	Battery
	Earth
	AC measurement
	Conforms to EU directives

## SAFETY

Review the following safety precautions to avoid injury and prevent damage to this product or products connected to it. To avoid potential hazards, use the product only as specified.

⚠ **CAUTION:** These statements identify conditions or practices that could result in damage to the equipment or other property.

⚠ **WARNING:** These statements identify conditions or practices that could result in personal injury or loss of life.

### Specific precautions

**Do not operate without covers.** To avoid personal injury, do not apply any voltage or current to the product without covers in place.

**Electric overload.** Never apply a voltage to a connector on the product that is outside the range specified for that connector.

**Avoid electric shock.** To avoid injury or loss of life, do not connect or disconnect probes or test leads while they are connected to a voltage source.

**Do not operate in wet/damp conditions.** To avoid electric shock, do not operate this product in wet or damp conditions.

## SPECIFICATIONS

All specifications are warranted unless noted typical and apply to the CM7.  
 Stated accuracies are at 23°C±5°C at than 80% relative humidity and without the battery indicator displayed.

### General specifications

Characteristics	Description
Display count	3 3/4
Numeric update rate	1.5 times / sec
Polarity display	Automatic
Overrange display	"OL" is display
Low voltage indicator	 is indicated
Automatic power-off time	Automatic backslit off = 30 minutes
Power source	One 9V battery
Maximum input voltage	600V CAT IV between V and COM
Maximum floating voltage	600V CAT IV between any terminal and earth
V connector	$V_{\sim}$ , $V_{\text{---}}$ , $\Omega$ , $\text{⦿}$
Temperature Coefficient	0.2×(Spec. Accuracy) / °C, <18°C or >28°C
Battery Life	100 hours typical (Alkaline)

**Measurement Characteristics**

Accuracy is  $\pm$ (% reading + number of digits) at  $23^{\circ}\text{C} \pm 5^{\circ}\text{C}$ , less than 80% R.H.

**Temperature coefficient:**  $0.2 \times$  (Specified accuracy)  $/^{\circ}\text{C}$ ,  $<18^{\circ}\text{C}$ ,  $>28^{\circ}\text{C}$

**Operating temperature:**  $0^{\circ}\text{C} \sim 30^{\circ}\text{C}$  ( $\leq 80\%$  RH)  
 $30^{\circ}\text{C} \sim 40^{\circ}\text{C}$  ( $\leq 75\%$  RH)  
 $40^{\circ}\text{C} \sim 50^{\circ}\text{C}$  ( $\leq 45\%$  RH)

**(1) AC Volts: Auto-ranging**

Range	Resolution	Accuracy	Over voltage protection
400.0V	100mV	$\pm(1.0\%$ reading + 5 digits) 50Hz ~ 500Hz	750V rms
750V	1V		

**Input Impedance :**  $\geq 1\text{M}\Omega$ // less than 100pF.

**AC Conversion Type:** Reading less Full Scale 15% add 4 dgt.

AC Conversions are ac-coupled, true rms responding, calibrated to the rms value of a sine wave input. Accuracies are given for sine wave at full scale and non-sine wave below half scale. For non-sine wave add the following Crest Factor corrections:

For Crest Factor of 1.4 to 2.0, add 1.0% to accuracy.

For Crest Factor of 2.0 to 2.5, add 2.5% to accuracy.

For Crest Factor of 2.5 to 3.0, add 4.0% to accuracy.

CF 2 @ 600V

1.5 @ 750V

**(2) DC Volts: Auto-ranging**

Range	Resolution	Accuracy	Over voltage protection
400.0V	100mV	$\pm(0.7\%$ reading + 2 digits)	1000V rms
1000V	1V		

**Input Impedance :**  $\geq 1\text{M}\Omega$

**(3) Resistance Auto-ranging**

Range	Resolution	Accuracy	Over voltage protection
400.0 $\Omega$	100m $\Omega$	$\pm(1.0\%$ reading + 3 digits)	600V rms

**Continuity:** Built-in buzzer sound when resistance is less than  $30\Omega$  approximately.

**(4) Frequency: Hz**

Range	Resolution	Accuracy	Over voltage protection
20Hz ~ 400Hz	1Hz	±(0.1% reading + 2 digits)	AC/DC 1000A for 1 min.

**Min. Input Frequency :** 20Hz

**Sensitivity:** 3A rms for ACA (A~)(>400Hz Unspecified)

**(5) ACA: Auto-ranging**

Range	Resolution	Accuracy	Frequency Response	Overload protection
0A ~ 200.0A	0.1A	±(1.9% reading + 3 Amp)	50Hz ~ 400Hz	1000A rms
200.0A ~ 400.0A	0.1A	±(1.9% reading + 2 Amp)		
400A ~ 1000A	1A	±(2.9% reading + 5 Amp)	50Hz ~ 200Hz	

**Operating Temperature:** 0°C to 30°C (≤80%RH), 30°C to 50°C (≤75%RH)

**AC Conversion Type:** Reading less Full Scale 15% add 4 dgt.

AC Conversions are ac-coupled, true rms responding, calibrated to the rms value of a sine wave input. Accuracies are given for sine wave at full scale and non-sine wave below half scale. For non-sine wave add the following Crest Factor corrections:

For Crest Factor of 1.4 to 2.0, add 1.0% to accuracy.

For Crest Factor of 2.0 to 2.5, add 2.5% to accuracy.

For Crest Factor of 2.5 to 3.0, add 4.0% to accuracy.

CF 2 @ 600V

1.5 @ 750V

**(6) DCA:**

Range	Resolution	Accuracy	Over voltage protection
0A ~ 200.0A	0.1A	±(2.9% reading + 3 Amp)	AC 1000A for 1 min.
200A ~ 400.0A		±(1.9% reading + 2 Amp)	
400A ~ 1000A	1A	±(2.9% reading + 5 Amp)	

Additional error according to remanence: 1% max. of current crest.

**(7) Auto Power Off (APO)**

The meter will automatically shut itself off after approximately 30 minutes after power on.

**(8) Peak Hold:  $\pm(3\%$  reading +20 digits)**

\* >750V Unspecified.

\* >800A Unspecified.

**(9) Min/Max Hold: Add  $\pm 15$  dgt to accuracy for ACA.**

Add  $\pm 15$  dgt and add remanence to accuracy for DCA.

\* Automatically switch to the low resolution range at Peak Hold and Min/Max Hold.



**Physical and Environmental Characteristics**

<b>Characteristics</b>	<b>Description</b>
Dimensions (H×W×D)	51mm×90mm×275mm
Weight (with battery)	420g
<b>Environmental characteristics</b>	<b>Description</b>
Temperature operating	0 to +50°C
Non-Operating	-20 to +60°C
Humidity (operating)	<80% R.H.
Altitude Operating	2,000M (6560 ft.)
Non-Operating	12,300M (40354 ft.)
Vibration & shock Operating	MIL-T-28800E TYPE II Class 5 3gRMS, 5 to 55 Hz, 3axes (10 minutes each)
Indoor Use	Indoor Use

**Certifications and compliances**

Safety	IEC 61010-1 600V CAT IV
Input rating	V / Ω: Category IV 600 Volts
Over voltage category	CAT IV: Equipment of OVERVOLTAGE CATERGORY IV is for use at the origin of the installations. Note examples include electricity meters and primary over-current protection equipment.
	CAT III: Distribution level mains, fixed installation.
	CAT II: Local level mains, appliances, portable equipment
	CAT I: Signal level, special equipment or parts of equipment, telecommunication, electronics.
Pollution Degree 2	Do not operate in environments where conductive Pollutants may be present.
EC Declaration of Conformity	Meets the intent of Directive 89/336/EEC for Electromagnetic Compatibility and Low Voltage Directive 73/23/EEC for specifications as listed in the official Journal of the European Communities: En 55011 Class A: Radiated and Conducted Emissions. En 50082-1 Immunity: IEC 801-2 Electrostatic Discharge IEC 801-3 RF Radiated En 61010-1 Safety requirements for electrical equipment for measurement, control, and laboratory use.

### Required Equipment

Required equipment is listed in Table B. If the recommended models are not available, equipment with equivalent specifications may be used.

Repairs or servicing should be performed only by qualified personnel.

**Table B. Required Equipment**

<b>Equipment</b>	<b>Required Characteristics</b>	<b>Recommended Model</b>
Calibrator	<b>AC Voltage Range:</b> 0 ~ 750V AC <b>Accuracy:</b> ±0.07% (Basic)  <b>Frequency Range:</b> 40 ~ 1KHz <b>Accuracy:</b> ±2%  <b>DC Voltage Range:</b> 0 ~ 1000V DC <b>Accuracy:</b> ±0.006% (Basic)  <b>Current Range:</b> 0 ~ 10A <b>Accuracy:</b> AC (40Hz to 1KHz): ±0.08% (Basic) DC: ±0.02% (Basic)  <b>Frequency Source:</b> 5.00Hz ~ 100MHz <b>Accuracy:</b> ±0.001%  <b>Amplitude:</b> 0.5V p-p ~ 1.0V p-p (square wave) <b>Accuracy:</b> ±5%  <b>Resistance Range:</b> 1Ω ~ 100MΩ <b>Accuracy:</b> ±0.03% (Basic)	Fluke 5500 or Wavetek 9100 Calibrator or equipment

## Basic Maintenance

### ⚠Warning

To avoid shock, remove the test leads and any input signals before opening the case or replacing the battery.

### Opening the Meter Case

#### ⚠Caution

To avoid unintentional shock circuit, always place the uncovered Meter assembly on a protective surface. When the case of the Meter is open, circuit connections are exposed.

To open the Meter case, and do the following:

1. Disconnect test leads from any live source, push the bottom the rotary to OFF.
2. Remove the battery door by using a flat-blade screwdriver to turn the battery door screws turn counter-clockwise.
3. The case bottom is secured to the case top by two screws. Using a Phillips-head screwdriver, remove the two screws.

### Replacing the Battery

The Meter powered by 9V battery for CM7.

To replace the battery refer to figure.

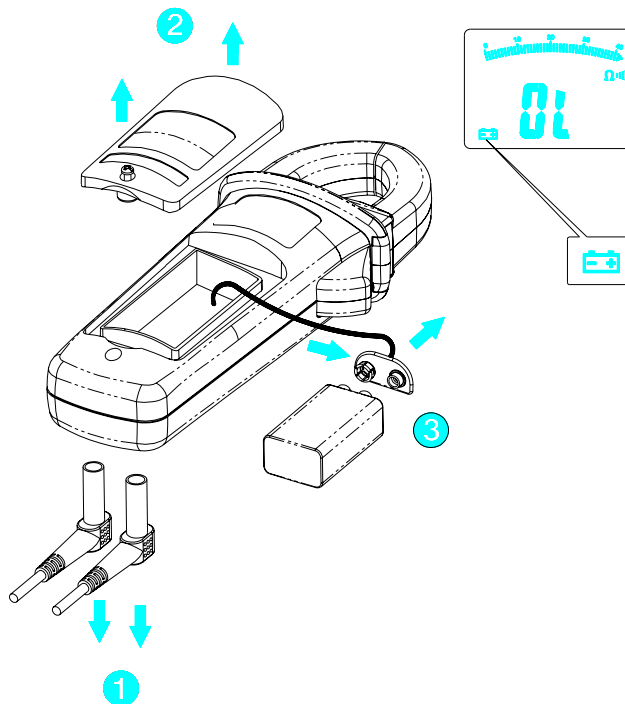

## Performance Tests

The following performance tests verify the complete operability of the Meter and check the accuracy of each Meter function against the Meter's specifications.

Accuracy specifications are valid for a period of one year after calibration, when measured at an operating temperature of 18°C to 28°C and a maximum of 80% relative humidity.

To perform the following tests, it is not necessary to open the case, no Adjustments are necessary, merely make the required connections, apply the designated inputs, determine if the reading on the Meter display falls within the acceptable range indicated.

If the Meter fails any of these tests, it needs calibration adjustment or repair.

### Testing the voltage Function

To verify accuracy in the AC and DC voltage ranges, do the following:

1. Turn the rotary switch to “**V~**” position.
2. Connect the Calibrator to the **VΩ** and **COM** inputs on the Meter.
3. Set the Calibrator for the voltage and frequency from step 1 to 4 in Table 1.
4. Compare the reading on the Meter display with the display reading shown in Table 1.
5. If the display reading falls outside of the range shown in Table 1, the Meter does not meet specification.

**Table 1 AC Voltage Test:**

Step	Input	Frequency	Reading
1	390.0V	50Hz	385.6 to 394.4
2	390.0V	500Hz	385.6 to 394.4
3	750V	50Hz	737 to 763
4	750V	500Hz	737 to 763

6. Turn the rotary switch to “**V**” position.
7. Set the calibration for the voltage from step 1 to 4 in Table 2.
8. Compare the reading on the Meter display with the display reading shown in Table 2.
9. If the display reading falls outside of the range shown in Table 2, the meter does not meet specification.

**Table 2 DC Voltage Test:**

Step	Input	Reading
1	390.0V	387.1 to 392.9
2	-390.0V	-387.1 to -392.9
3	1000V	991 to 1009
4	-1000V	-991 to -1009

### Testing the Resistance Function

To verify the accuracy of the resistance function, do the following:

1. Connect the calibrator to **VΩ** and **COM** on the Meter.
2. Turn the rotary switch to Ω.
3. Apply the inputs for step 1 in Table 3.
4. Compare the Meter display readings to the display readings in Table 3.
5. If the display reading falls outside of the range shown in Table 3, the Meter does not meet specification.

**Table 3 Resistance Test:**

Step	Source	Reading
1	380.0Ω	375.9 to 384.1

**Continuity check:** Internal sounds activates if the resistance of the circuit under test is less the 30Ω.

### Testing the AC Current Function

To verify the accuracy of AC current measurement functions, do the following:

1. Using jaw of the meter around the suitable wire or conductor.
2. Turn the rotary switch to A.
3. Apply the inputs for steps 1-2 in Table 4.
4. For each input, compare the readings on the Meter display to the reading in Table 4.
5. If the display reading falls outside of the range shown in the Table 4, the meter does meet specification.

**Table 4 AC Current Test:**

Step	Source	Frequency	Reading
1	380.0A	50Hz to 400Hz	370.8 to 389.2
3	1000A	50Hz to 200Hz	966 to 1034

### Testing the DC Current Function

To verify the accuracy of DC current measurement functions, do the following:

1. Using jaw of the meter around the suitable wire or conductor.
2. Turn the rotary switch to A.
3. Apply the inputs for steps 1-2 in Table 5.
4. For each input, compare the readings on the Meter display to the reading in Table 5.
5. If the display reading falls outside of the range shown in the Table 5, the meter does meet specification.

**Table 5 DC Current Test:**

Step	Source	Reading
1	380.0A	370.8 to 389.2
2	1000A	966 to 1034

### Testing the Hz Function

To verify the accuracy of Hz current measurement functions, do the following:

1. Using jaw of the meter around the suitable wire or conductor.
2. Turn the rotary switch to Hz.
3. Apply the inputs for steps 1-2 in Table 6.
4. For each input, compare the readings on the Meter display to the reading in Table 6.
5. If the display reading falls outside of the range shown in the Table 6, the meter does meet specification.

**Table 6 Hz Current Test:**

Step	Source	Reading
1	0.020KHz	0.018 to 0.022
2	0.400KHz	0.398 to 0.402

## Calibration Procedure

Recalibrate your meter:

It is recommended that the meter may be calibrated once year. Use the following procedure to calibrate the clamp meter.

1. Perform calibration at an ambient temperature and a relative humidity ( $23^{\circ}\text{C}\pm 2^{\circ}\text{C}$  and  $\text{RH}\leq 80\%$  ). Allow instrument to sit at this temperature for at least thirty minutes.
2. Disconnect the test leads and turn the meter off. Remove the test leads from the front terminals.
3. Position the meter face down. Remove the front screw and back screw from the case bottom.
4. Lift the case bottom from the circuit board. Do not remove the screw from the circuit board.

### (A) DCV Calibration (Adjust VR1)

1. Set the clamp meter at DCV function.
2. Set the output of DC calibrator for  $300\text{V}\pm 0.02\%$  and connect to V- $\Omega$  and COM input terminals on clamp meter.
3. Using a small flat-tipped screwdriver adjust the potentiometer VR1 until the display reads 300.0 or 300.1.
4. Disconnect the DC calibrator from the clamp meter.

### (B) ACV Calibration (Adjust VR2)

1. Set the clamp meter at ACV function.
2. Set the output of AC calibrator for  $300\text{V}\pm 0.02\%$  50Hz and connect to V- $\Omega$  and COM input terminals on clamp meter.
3. Using a small flat-tipped screwdriver adjust the potentiometer VR2 until the display reads 299.9 or 300.1.
4. Disconnect the DC calibrator from the clamp meter.

### (C) Position Error Calibration (Adjust VR101)

1. Set the clamp meter at DCA function.
2. Flow the current of AC 100A/50Hz around the suitable wire or conductor.
3. Open spring-loaded clamp pressing trigger on the right side of instrument.
4. Position clamp around wire or conductor and release trigger to make sure the clamp is entirely closed.
5. Using a small flat-tipped screwdriver adjust the VR101 until the error is limited under 0.2% while position the.
6. Disconnect the clamp from the wire on conductor.

### (D) DCA Zero Calibration (Adjust VR102, VR105)

1. Set the clamp meter at DCA function.
2. Using a small flat-tipped screwdriver adjust the VR102 until the display shows  $0.0\pm 20$  digits.
3. Using a small flat-tipped screwdriver adjust the VR105 until the display shows  $0.0\pm 2$  digits.



**(E) AC 400A Range Calibration (Adjust VR104)**

1. Set the clamp meter at ACA function.
2. Flow the current of AC  $360A \pm 0.02\%$ /50Hz around the suitable wire or conductor.
3. Position clamp around wire or conductor and release trigger to make sure the clamp is entirely closed.
4. Reposition the clamp to make the wire or conductor is in the center of the clamp.
5. Using a small flat-tipped screwdriver adjust the potentiometer VR104 until the display reads 367.0 or 367.2.
6. Disconnect the clamp from the wire on conductor.

**(F) AC 1000A Range Calibration (Adjust VR103)**

1. Set the clamp meter at ACA function.
2. Flow the current of AC  $700A \pm 0.02\%$ /50Hz around the suitable wire or conductor.
3. Position clamp around wire or conductor and release trigger to make sure the clamp is entirely closed.
4. Reposition the clamp to make the wire or conductor is in the center of the clamp.
5. Using a small flat-tipped screwdriver adjust the potentiometer VR103 until the display reads 699 or 701.
6. Disconnect the clamp from the wire on conductor.

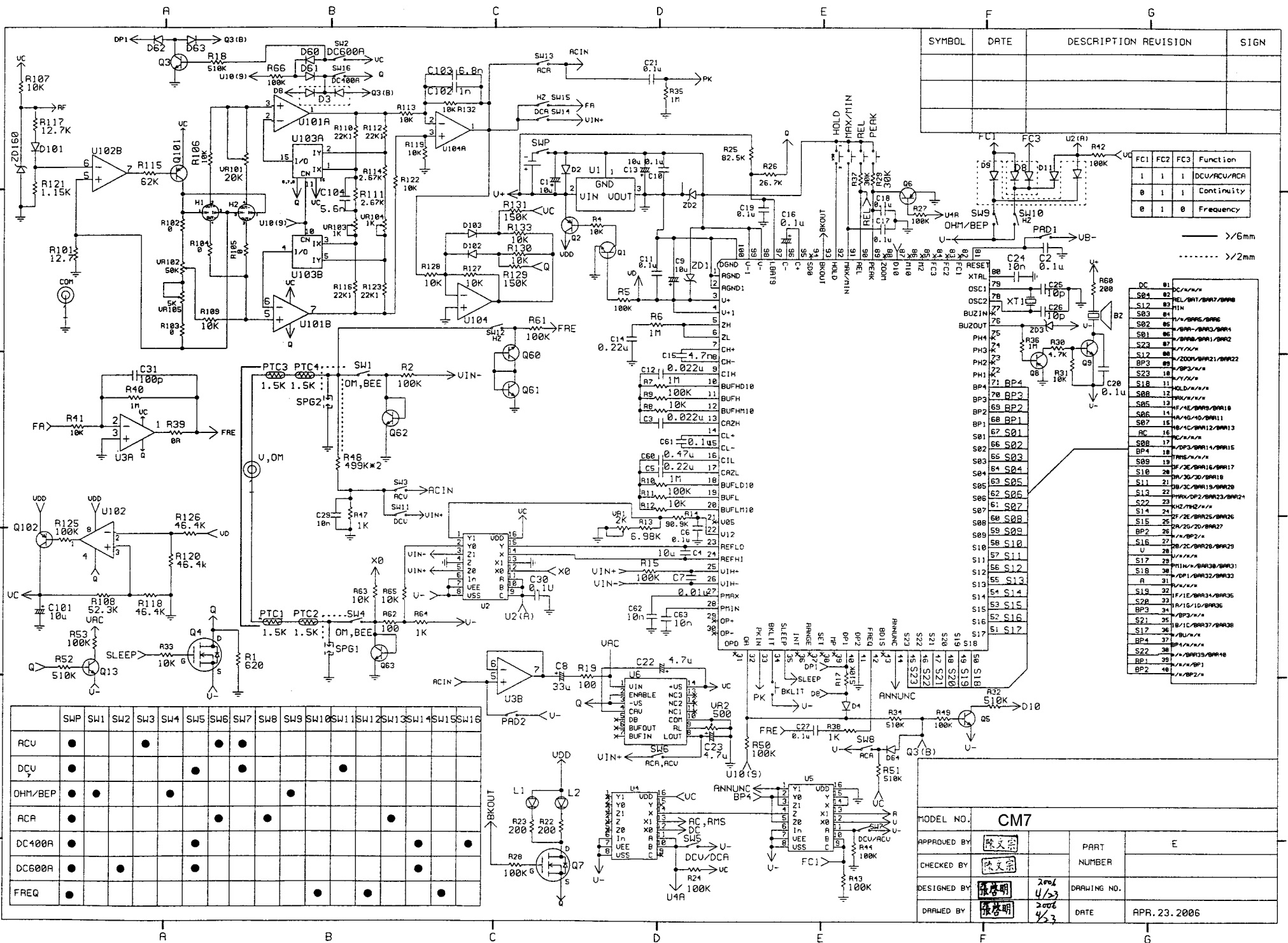

SYMBOL	DATE	DESCRIPTION	REVISION	SIGN

FC1	FC2	FC3	Function
1	1	1	DCU/ACU/ACA
0	1	1	Continuity
0	1	0	Frequency

DC	Component	Value
S04	01	DCU/ACU
S04	02	REL/BA1/BA17/BA18
S12	02	MIN
S03	04	MIN
S02	05	DCU/ACU/ACA
S01	05	DCU/ACU/ACA
S01	06	DCU/ACU/ACA
S01	07	DCU/ACU/ACA
S12	08	DCU/ACU/ACA
S03	08	DCU/ACU/ACA
S23	09	DCU/ACU/ACA
S18	10	DCU/ACU/ACA
S08	12	HOLD/...
S05	12	DCU/ACU/ACA
S06	14	DCU/ACU/ACA
S07	15	DCU/ACU/ACA
AC	16	DCU/ACU/ACA
S08	17	DCU/ACU/ACA
BP4	18	DCU/ACU/ACA
S03	19	DCU/ACU/ACA
S04	20	DCU/ACU/ACA
S10	20	DCU/ACU/ACA
S11	21	DCU/ACU/ACA
S03	21	DCU/ACU/ACA
S13	22	DCU/ACU/ACA
S22	23	DCU/ACU/ACA
S14	24	DCU/ACU/ACA
S08	25	DCU/ACU/ACA
S09	25	DCU/ACU/ACA
BP2	26	DCU/ACU/ACA
S16	27	DCU/ACU/ACA
U	28	DCU/ACU/ACA
S17	29	DCU/ACU/ACA
S18	30	DCU/ACU/ACA
A	31	DCU/ACU/ACA
S19	32	DCU/ACU/ACA
S28	33	DCU/ACU/ACA
BP3	34	DCU/ACU/ACA
S21	35	DCU/ACU/ACA
S17	36	DCU/ACU/ACA
BP4	37	DCU/ACU/ACA
S22	38	DCU/ACU/ACA
S01	39	DCU/ACU/ACA
BP2	40	DCU/ACU/ACA

	SWP	SW1	SW2	SW3	SW4	SW5	SW6	SW7	SW8	SW9	SW10	SW11	SW12	SW13	SW14	SW15	SW16
ACU	●			●			●	●									
DCU	●						●				●						
OHM/BEP		●															
ACA	●								●								
DC400A	●		●														
DC600A	●																
FREQ	●																

MODEL NO.	CM7		E	
APPROVED BY	張文宗	PART NUMBER		
CHECKED BY	張文宗	DESIGNED BY	張啓明	DATE
DESIGNED BY	張啓明	DATE	2006 4/23	DRAWING NO.
DRAWN BY	張啓明	DATE	2006 4/23	APR. 23. 2006

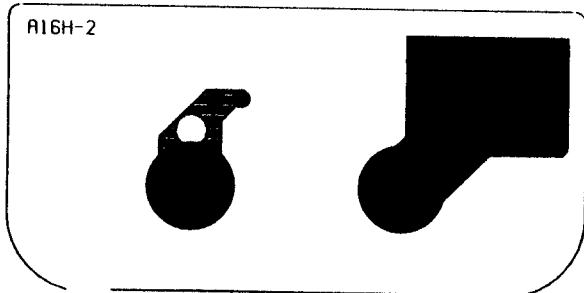
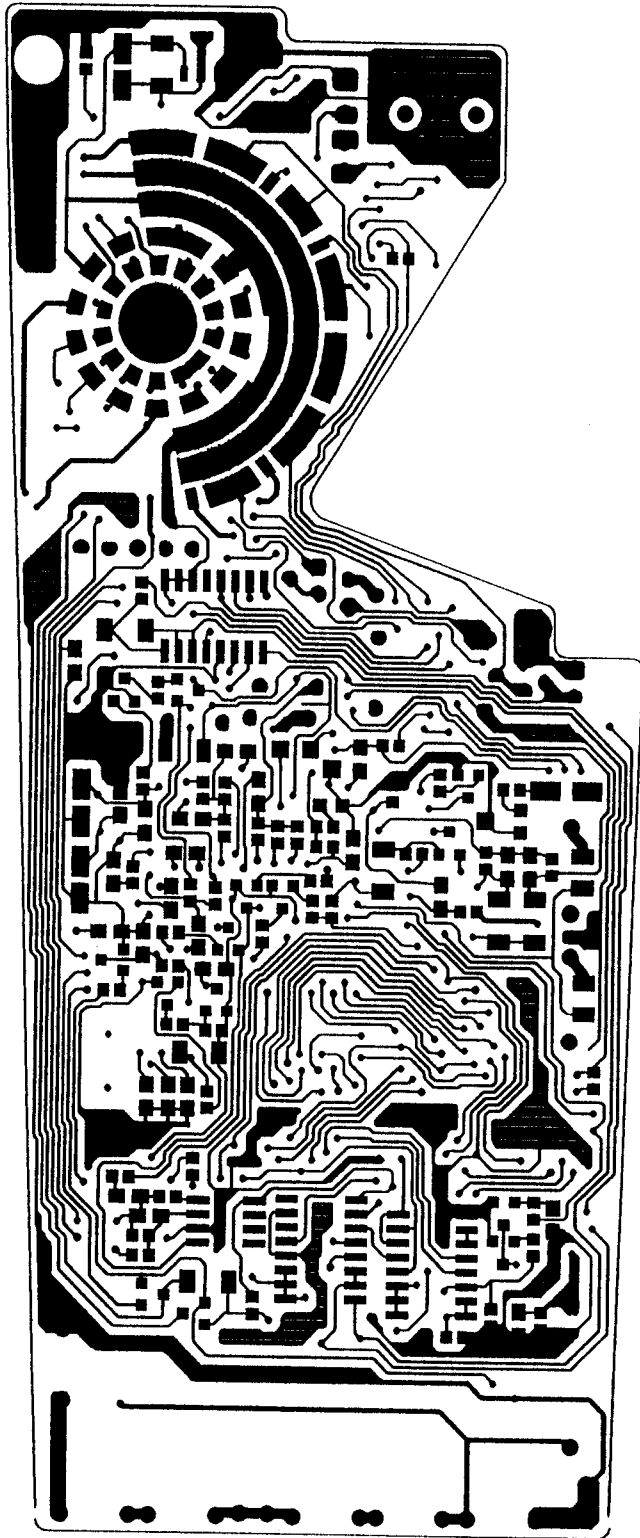

MODE NO.	PART NO. A16H-1E
LAYER: COMPONENT SIDE	DATE: 92.09.30

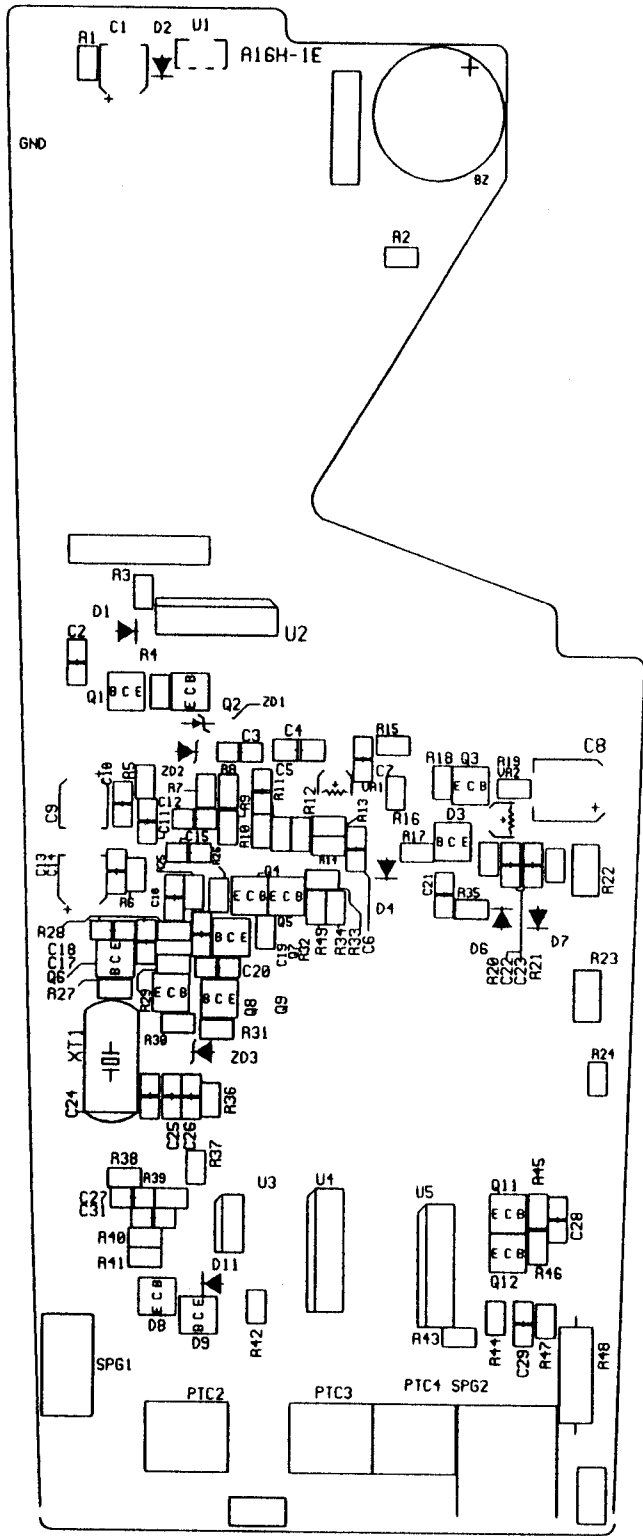

MODE NO.	PART NO. A16H-1E
LAYER: SILKSCREEN (TOP) DATE: 92,09,30	

L

ГЛАВ: ЭДС СТОЛ	DATE: 25.08.30
MODE: NO.	BRIT: VIEW-IE

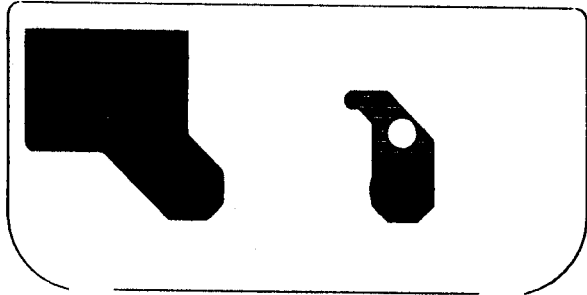
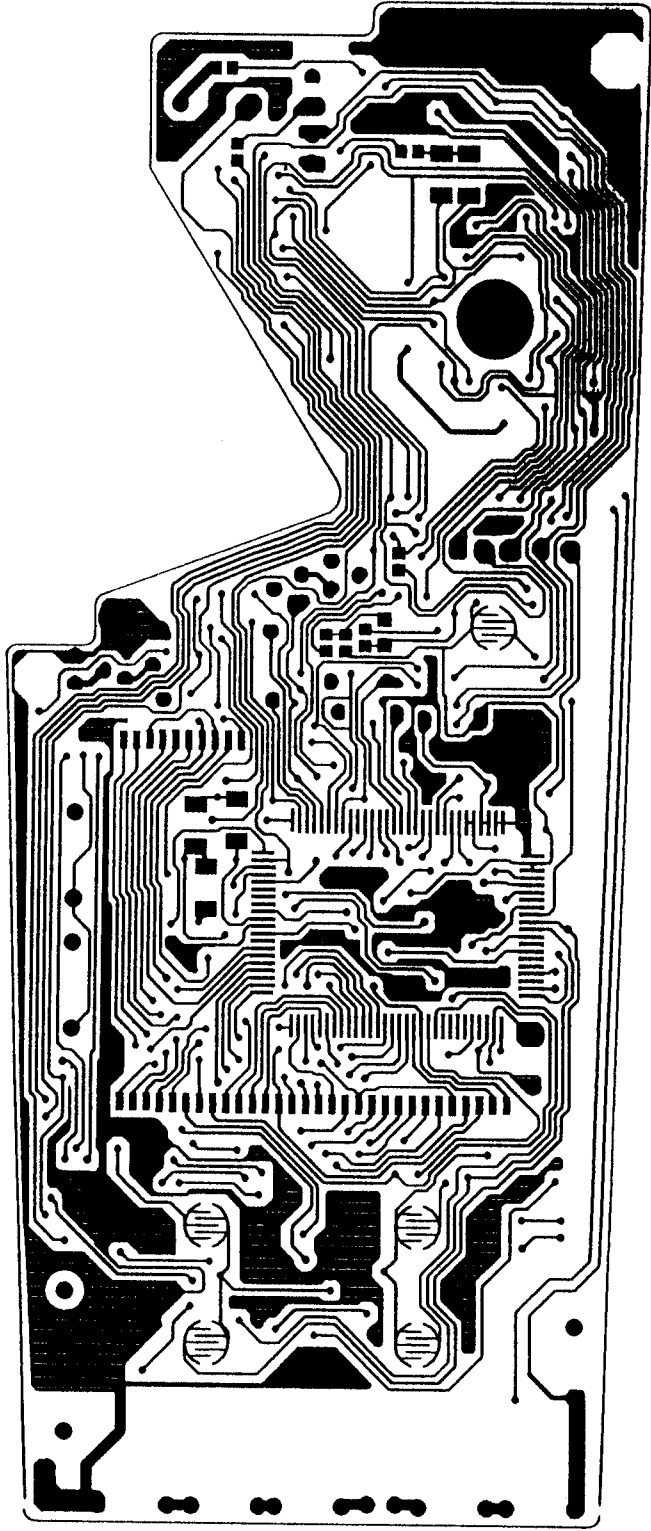

ГРАФЕР: ЗІГКЗСРЕЕН (ВОЛ) ДИЛЕ:ДС \*02 \*30  
 МОДЕ НО\* БРПІ НО\* АІМН-ІЕ

