



TESTBOY TV 450
TESTBOY TV 450 (Type B)
Short instructions
Version 1.1, Code no. 20 751 768

Distributor:

Manufacturer:

Testboy GmbH
Elektrotechnische Spezialfabrik
Beim Alten Flugplatz 3
D - 49377 Vechta

Tel: 0049 (0)4441 / 89112-10
Fax: 0049 (0)4441 / 84536

www.testboy.de
info@testboy.de



Mark on your equipment certifies that this equipment meets the requirements of the EU (European Union) concerning safety and electromagnetic compatibility regulations

© 2009 TESTBOY

No part of this publication may be reproduced or utilized in any form or by any means without permission in writing from TESTBOY.

Table of contents

1	Start-up guide	4
1.1	Safety and operational considerations	4
1.2	Instrument description - Front and connector panel	5
1.3	Instrument description - Meaning of symbols	5
1.4	Function selector switch and instrument display	7
1.5	Battery handling	7
1.6	Maintenance	8
1.6.1	Replacing fuses	8
1.7	Warranty & Repairs	9
2	Quick-test guide	10
2.1	Null the leads	10
2.2	Measurements	11
2.2.1	Online Voltage and frequency / Phase sequence - AC Voltage measurement and frequency measurements, phase sequence	11
2.2.2	Insulation resistance - For testing the M Ω value of the insulation between wires	13
2.2.3	Low Ω for testing Resistance of earth conductors and equipotential bonding	15
2.2.4	RCD testing - 3 functions for testing RCDs	17
2.2.5	Loop - Fault loop impedance	19
2.2.6	Line impedance - (phase-neutral, phase-phase)	21
2.2.7	Earthing resistance (model TESTBOY TV 450 (Type B))	22
3	Step by step PC SW installation (model TESTBOY TV 450 (Type B))	23

1 Start-up guide

1.1 Safety and operational considerations

Warnings

- This document is not a supplement to the Instruction manual!
- Before using the instrument read the instruction manual carefully otherwise use of the instrument may be dangerous for the operator, for the instrument or for equipment under test!
-  Symbol on the instrument means »Read the Instruction manual with special care«. The symbol requires an action!
- If the test equipment is used in a manner not specified in instruction manual the protection provided by the equipment may be impaired!
- Do not use the instrument or any of the accessories if any damage is noticed!
- In case a fuse has blown follow the instructions in instruction manual to replace it!
- Consider all generally known precautions in order to avoid risk of electric shock while dealing with hazardous voltages!
- Do not use the instrument in supply systems with voltages higher than 550 V!
- Service intervention or adjustment procedure is only authorized to be carried out by competent people, authorized and trained by TESTBOY!
- Use only standard or optional test accessories supplied by your distributor!
- Consider that older and some of new optional test accessories could be compatible with this instrument but only meet a CAT III / 300 V overvoltage category! If this is the case, this implies that the maximum voltage allowed between test terminals and ground is 300 V!
- The instrument is supplied with rechargeable Ni-MH battery cells. These battery cells should only be replaced with the same type (as defined on the battery placement label and in the instruction manual). Do not use standard alkaline battery cells while the power supply adapter is connected otherwise they may explode!
- Hazardous voltages can exist inside the instrument. Disconnect all test leads, remove the power supply cable and switch off the instrument before removing the battery compartment cover. All normal safety precautions must be taken in order to avoid the risk of electric shock when working on electrical installations!

1.2 Instrument description - Front and connector panel



(picture of TESTBOY TV 450 (Type B))

Instrument description

1. Display
2. TEST button
3. Arrow key
4. Arrow key
5. TESTBOY TV 450 (Type B): MEM button TESTBOY TV 450: CAL button (for zeroing out leads)
6. Function Selector
7. Backlight button
8. On/off button
9. TESTBOY TV 450 (Type B): HELP (to enter help screens), CAL button
10. TESTBOY TV 450: HELP button
11. TAB button (for changing test parameters)
12. Pass indicator
13. Fail indicator

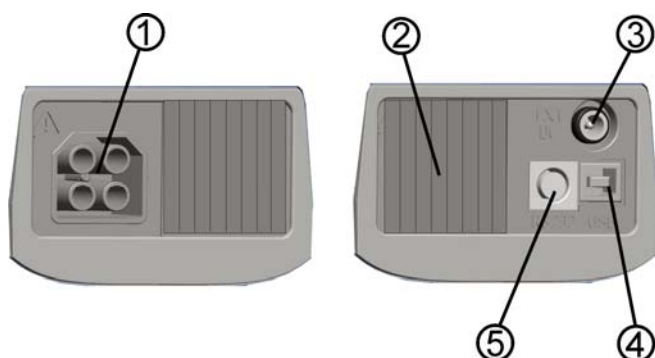

(picture of TESTBOY TV 450 (Type B))

Connectors

1. Test lead socket
2. Cover
3. Charger socket
4. TESTBOY TV 450 (Type B): USB connector
5. RS232 (serial) connector

1.3 Instrument description - Meaning of symbols

The online voltage and output terminal monitor

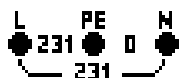

Online voltage is displayed together with test terminal indication. All three test terminals are used for selected measurement.

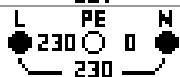

Online voltage is displayed together with test terminal indication. L and N test terminals are used for selected measurement.

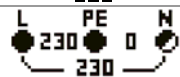

L and PE are active test terminals; N terminal should also be connected for correct input voltage condition.



L – N polarity changed.





Test leads resistance in Continuity measurement is not compensated.













Test leads resistance in Continuity measurement is compensated.



Message field – battery status

	Battery capacity indication.
	Low battery. Battery is too weak to guarantee correct result. Replace or recharge the battery cells.
	Recharging in progress (if power supply adapter is connected).

Message field – measurement warnings/messages

	Warning! High voltage is applied to the test terminals.
	Warning! Phase voltage on the PE terminal! Stop all the measurements immediately and eliminate the fault before proceeding with any activity!
	Measurement is running. Consider any displayed warnings!
	Measurement can be performed after pressing the TEST key. Consider any displayed warning after starting the measurement!
	Measurement prohibited. Consider any displayed warnings and check online voltage/terminal monitor!
	Result(s) can be stored.
	High electrical noise was detected during measurement. Results may be impaired.
	RCD tripped during the measurement. The trip limit may be exceeded as a result of leakage current flowing to the PE protective conductor or capacitive connection between L and PE conductors.
	Instrument overheated. Temperature of internal components in the instrument reached top limit. Measurement is prohibited until the temperature is lower than that limit.
	High resistance to earth of test probes. Results may be impaired TESTBOY TV 450 (Type B)

Result field

	Measurement result is inside pre-set limits (PASS).
	Measurement result is out of pre-set limits (FAIL).
	Measurement is aborted. Consider displayed warnings and messages.

Sound warnings

Continuous sound	Warning! Dangerous voltage on the PE terminal is detected.
-------------------------	--

1.4 Function selector switch and instrument display

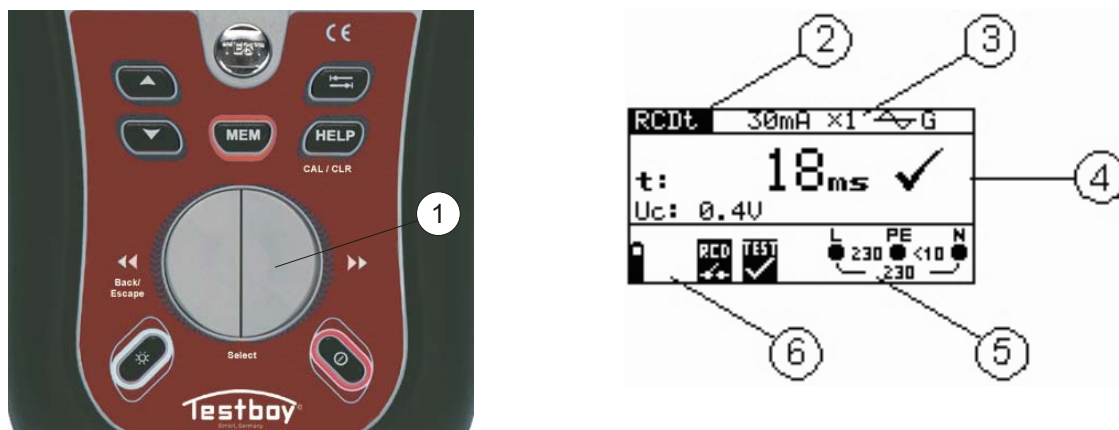

(picture of TESTBOY TV 450 (Type B))

Legend:

1. Function switch.
2. Function or sub-function name.
3. Measuring parameters and limit values.
4. Result field.

In this field the main and sub-results together with the PASS/FAIL/ABORT status are displayed.

5. Online voltage and output monitor.

6. Message field.

In this field battery status and warnings/messages related to the actual measurement are displayed.

1.5 Battery handling

- ❑ When replacing battery cells or before opening battery/fuse compartment cover, disconnect any test leads/accessory connected to the instrument and switch off the instrument. Hazardous voltage can exist inside the instrument!
- ❑ Insert all cells correctly! If this is not performed correctly, the instrument will not operate and the battery could be discharged.
- ❑ If the instrument is not used for a long period of time, remove all of the battery from the battery compartment to protect the instrument from leakage.
- ❑ Alkaline or rechargeable Ni-MH battery cells (size AA) can be used. The operating hours are given for cells with a nominal capacity of 2100 mAh.

Do not recharge alkaline battery cells! The battery will begin charging as soon as the power supply adapter is connected to the instrument. The in-built protection circuits control the charging procedure...



Power supply socket polarity

Note:

Only use the power supply adapter delivered from manufacturer or distributor of the test equipment to avoid possible fire or electric shock!

1.6 Maintenance

1.6.1 Replacing fuses

Fuse

M 0.315 A / 250 V, 20 x 5 mm

This fuse protects internal circuitry of low-value resistance function if test probes are connected to the mains supply voltage by mistake.

Warnings:

- ❑ Disconnect any test leads/accessories from the instrument and switch off the instrument before opening battery/fuse compartment cover. Hazardous voltage can exist inside the instrument!
- ❑ In case a fuse has blown in the instrument, follow the instructions in instruction manual to replace it!
- ❑ Replace any blown fuses with exactly the same type of fuse. Inserting the wrong fuse into the instrument can impair the operator's safety and/or damage the instrument.

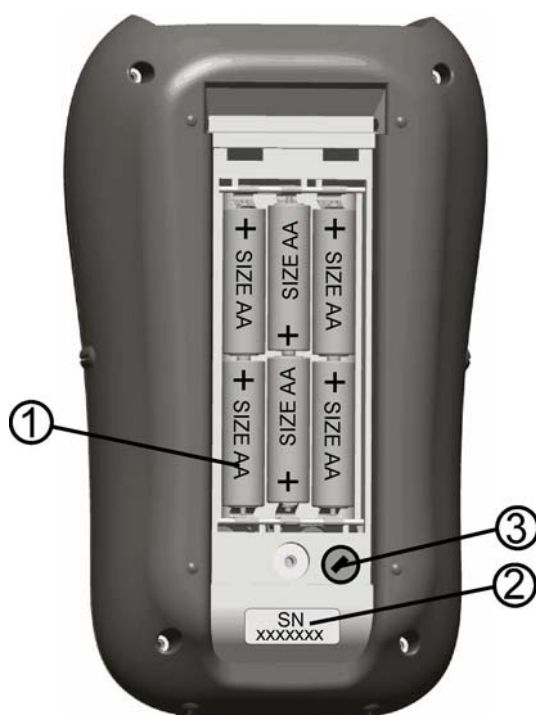

1.7 Warranty & Repairs

Any potentially defective items should be returned to TESTBOY accompanied by information regarding the faults that was incurred. It is recommended that any defective equipment is sent back to TESTBOY via the Partner Distributor from which the product was purchased.

All defective products will be replaced or repaired within policy period. For these items, a full refund will only be issued if a sufficient replacement is not available. Any shipping / return-shipping costs are not refundable.

TESTBOY shall not be held liable for any loss or damage resulting from the use or performance of the products. In no event shall TESTBOY be liable to the customer or its customers for any special, indirect, incidental, exemplary or punitive damages resulting from loss of use, interruption of business or loss of profits, even if TESTBOY has been advised of the possibility of such damages.

If the customer's unit is out of warranty but needs repairs, a quote for repair will be provided via the Partner Distributor through which the instrument was sent in.

Notes

- ❑ Any unauthorized repair or calibration of the instrument will infringe the product's warranty.
- ❑ All sales are subject to TESTBOY Standard Terms and Conditions. TESTBOY reserves the right to change the conditions at any time. Any typographical, clerical or other error or omission in any sales literature, quotation, price list, acceptance of offer, invoice or other documentation or information issued by TESTBOY shall be subject to correction without any liability on the part of the customer.
- ❑ Specifications and designs of goods are subject to change by TESTBOY at any time without notice to the customer. TESTBOY reserves the right to make any changes in the specification of goods which are required to conform with any applicable statutory or EC requirements or, where goods are to be supplied to TESTBOY specification, which do not materially affect their quality or performance.
- ❑ If a condition was found to be invalid or void it would not affect the overall validity of the remainder of the conditions;
- ❑ TESTBOY are excluded from liability for any delays or failure to comply, where the reason is beyond TESTBOY control;
- ❑ No order which has been accepted by TESTBOY may be cancelled by the customer except with the agreement in writing of TESTBOY and on terms that the customer shall indemnify TESTBOY in full against all loss (including loss of profit), costs (including the cost of all labour and materials used), damages, charges and expenses incurred by TESTBOY as a result of cancellation. The minimum charge for such cancellation will be 25 % of the total value of the goods ordered.

2 Quick-test guide

2.1 Null the leads

Starting the tester:

1. Insert the fully charged batteries
2. Press the On/Off button
3. Connect test cable to the instrument.

① Step

- Select Continuity function (R LOW Ω or CONTINUITY*) with the function selector switch first. The following menu is displayed:

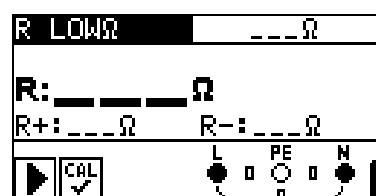

② Step

- Short test leads first as shown.

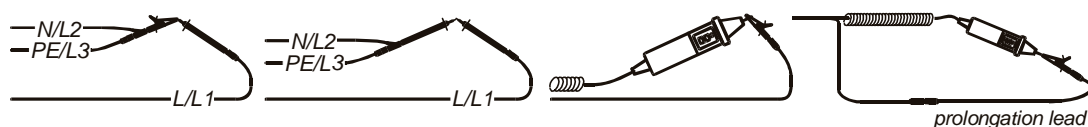

③ Step

- Press the TEST key in order to perform regular measurement. Result close to 0.00 Ω is displayed.

④ Step

- Press the CAL key. After performing test leads compensation first measured value and then 0.00 Ω is displayed. If calibration was carried out successfully leads indicator **CAL** is shown in R LOW Ω and CONTINUITY* menus.

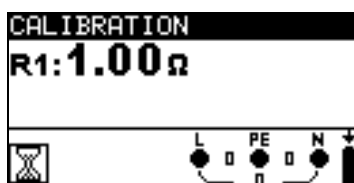

Measured value to be calibrated.

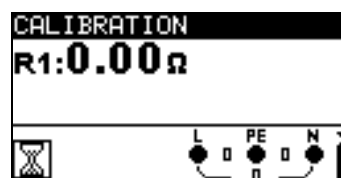

Reading at calibrated value is 0.00 Ω now.

* The CONTINUITY subfunction is available in model TESTBOY TV 450 (Type B).

2.2 Measurements

2.2.1 Online Voltage and frequency / Phase sequence - AC Voltage measurement and frequency measurements, phase sequence

- ❑ Monitors voltages between L-N, L-PE and N-PE at the same time
- ❑ Values shown in real-time
- ❑ System can also be used on 3 phase systems for monitoring voltages between phases
- ❑ Phase sequencing should be checked on 3 phase systems.
- ❑ System shows values e.g. 1,2,3 or 2,1,3 which relate to the green, blue and black test leads to show rotation

① Set function

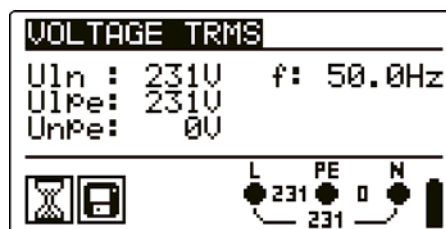
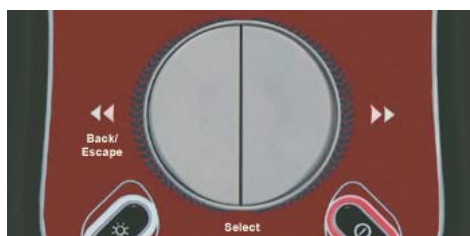

② Connection diagram

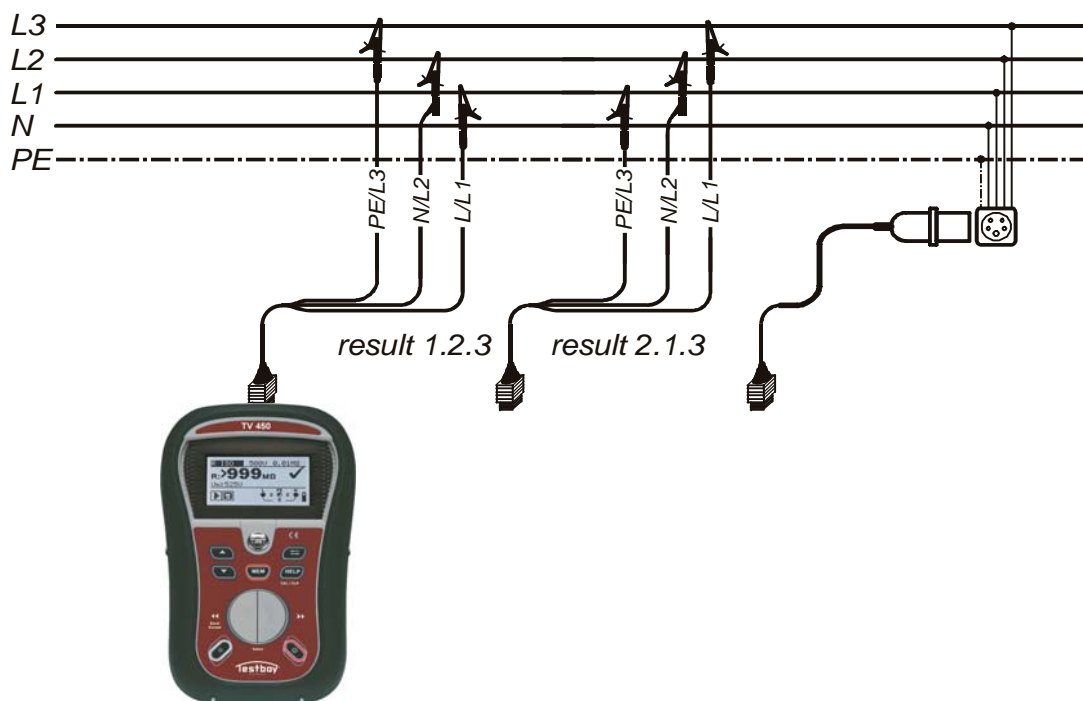

③ View results

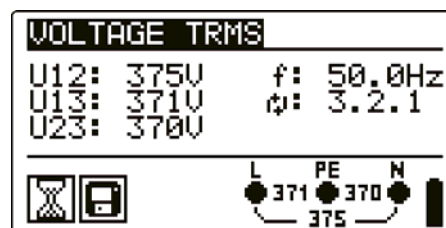
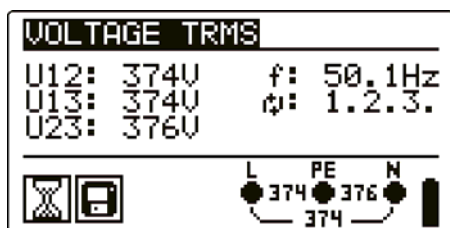

Displayed results:

- UI(1)-n(2): Voltage between phase and neutral conductors (or between phases L1 and L2)
- UI(1)-pe(3): Voltage between phase and protective conductors (or between phases L1 and L3)
- Un(2)-pe(3): Voltage between neutral and protective conductors (or between phases L2 and L3)
- 1.2.3: Correct connection – CW rotation sequence,
- 3.2.1: Invalid connection – CCW rotation sequence,
- f: frequency

2.2.2 Insulation resistance - For testing the MΩ value of the insulation between wires

- ❑ Test Voltages can be changed from 50 V to 1000 V
- ❑ Selectable limits can be set “on-screen” for quick evaluation of results

① Set function

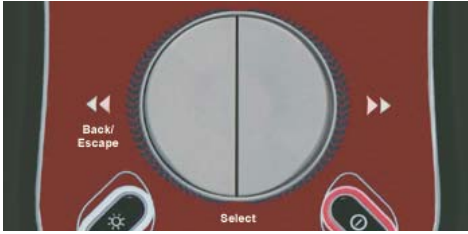

② Set parameters and limits

- ❑ Nominal test voltage (50 VDC ÷ 1000 VDC)
- ❑ Low limit resistance Ω sets limit off, 0.01 MΩ ÷ 200 MΩ



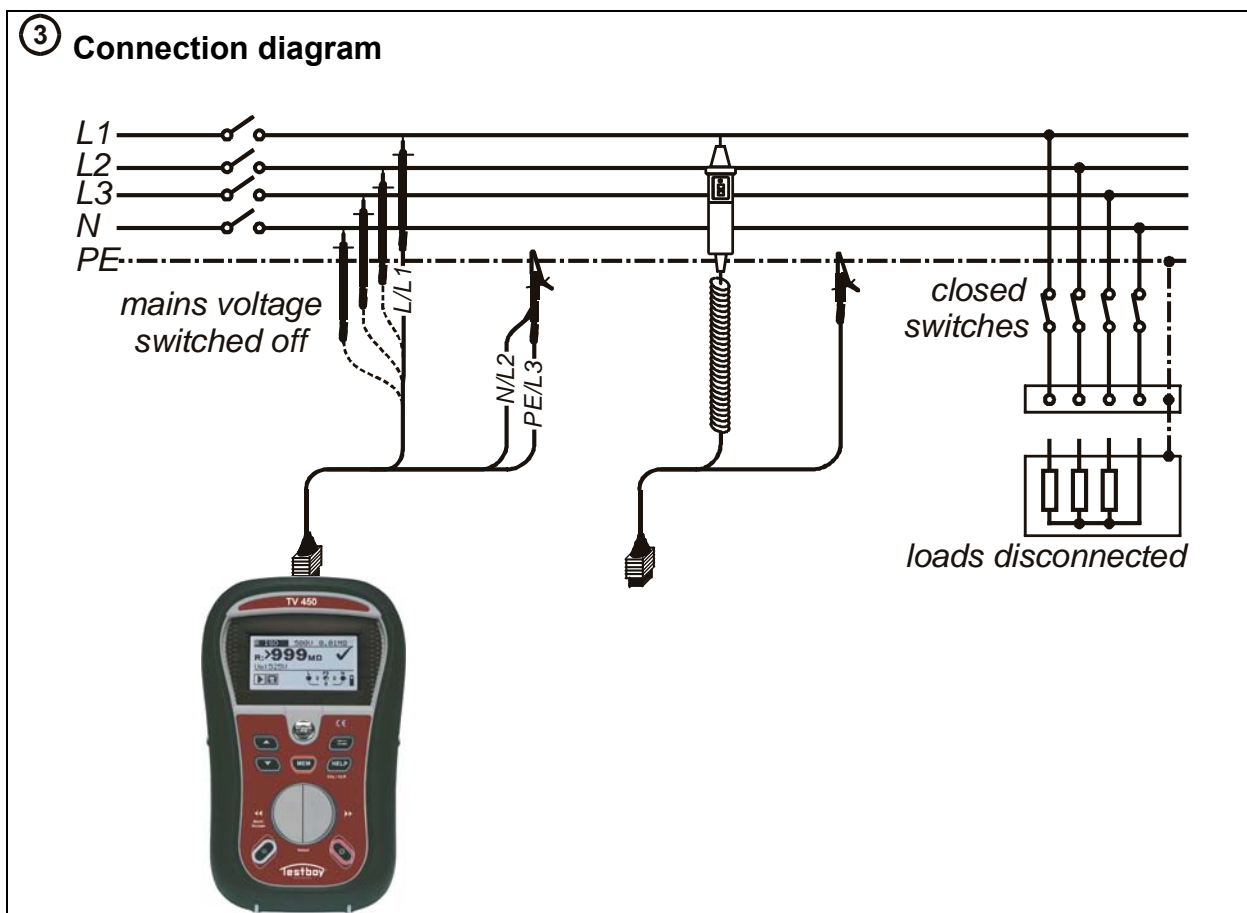

- ④ Press and hold the  key until result has stabilised.

- ⑤ View results



Displayed results:
R: Insulation resistance
Um: Instrument test voltage

2.2.3 Low Ω for testing Resistance of earth conductors and equipotential bonding

R LOW Ω

- 200 mA continuity test
- Polarity automatically swapped during test (results displayed on screen).

CONTINUITY (model TESTBOY TV 450 (Type B))

- Lower current which continually tests the system
- Used when testing induction systems (e.g. motor windings etc).

① Set function

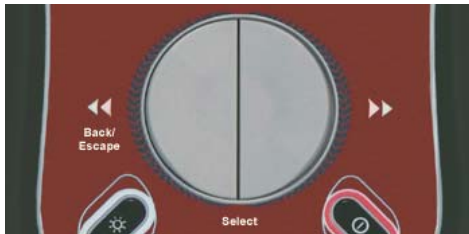

② Set subfunction

- R LOW Ω
- CONTINUITY*

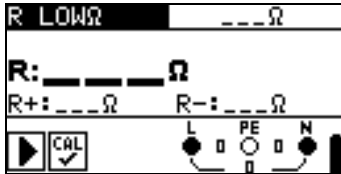
③ Set parameters and limits

- High limit resistance Ω sets limit off, 0.1 Ω ÷ 20.0 Ω]



④ Set parameters and limits

R LOW Ω

MPEC...Main Potential Equilizing Collector
PCC...Protection Conductor Collector

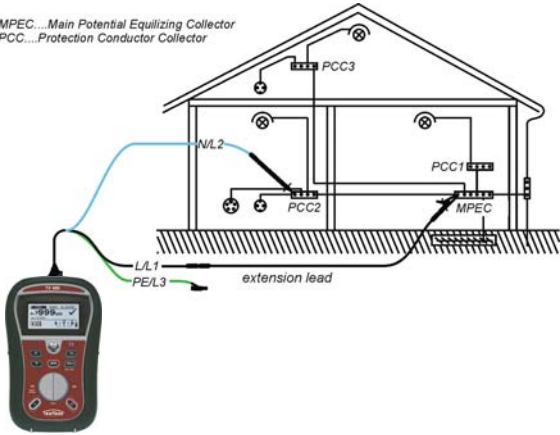

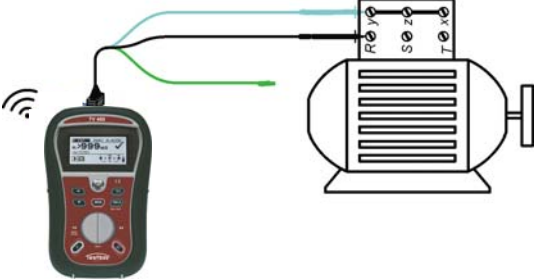

CONTINUITY*



⑤

R LOW Ω:
 Press the  key

CONTINUITY*:
 Press the  key to start
 Press the  key to stop

⑥ **View results**

R LOW Ω

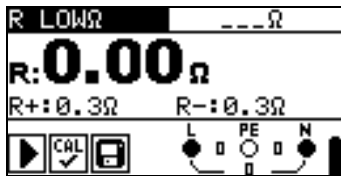

Displayed results:
R: Main LowΩ resistance result
R+: LowΩ resistance sub-result with positive voltage at L terminal
R-: LowΩ resistance sub-result

CONTINUITY*

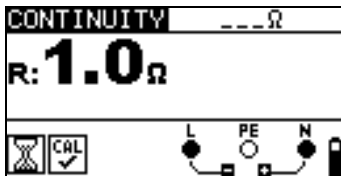

Displayed results:
R: Main continuity resistance result

* The CONTINUITY subfunction is available in model TESTBOY TV 450 (Type B)

2.2.4 RCD testing - 3 functions for testing RCDs.

U_c

- For testing contact voltage on exposed earthed conductive parts.

RCD t



- For testing the time it takes for an RCD to trip.
- Tripping currents can be multiplied by x1/2, x1, x2 and x5.

RCD I

- RCD ramp test.
- RCD ramp slowly increases the tripping current to find the minimum fault current required to trip an RCD.
- Useful in faultfinding nuisance RCD tripping.



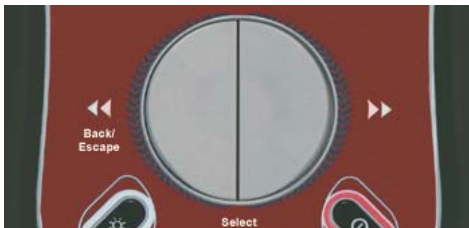

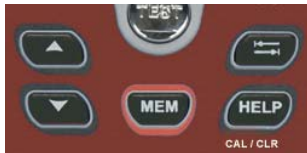
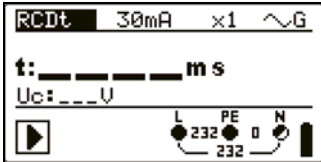

AUTO

- A automated test of the most important parameters associated with an RCD via one press of a button.
- If a faulty parameter is noticed during the autotest, the test will stop to highlight the need for further investigation.

<p>① Set function</p> 	<p>② Set subfunction</p> <ul style="list-style-type: none"> □ U_c □ RCD t □ RCD I □ AUTO 
--	---

③ **Set parameters and limits**

- Limit contact voltage (25 V, 50 V)
- Nominal differential RCD tripping current (10 mA ÷ 1000 mA)
- Multiplier of nominal differential RCD tripping current (x1/2, x1, x2, x5)
- RCD type [**G**, **S**], test current waveform plus starting polarity [, , , , , *].

* TESTBOY TV 450 (Type B) only

④ Connection diagram

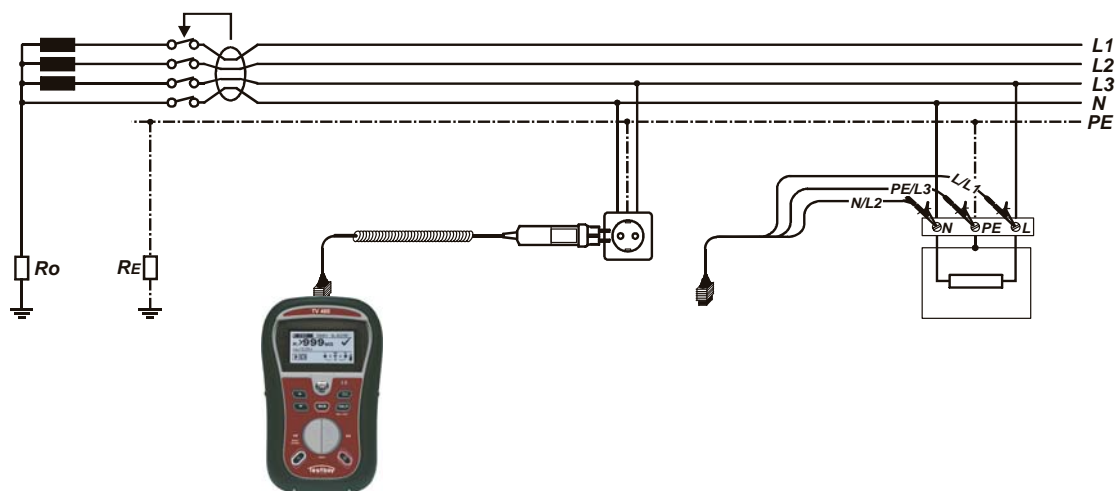

⑤ Press the  key

⑥ View results

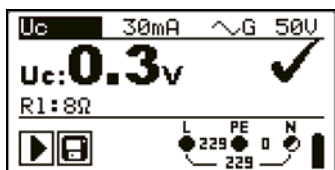

Displayed results:
 Uc: Contact voltage
 RL: Fault loop resistance



Displayed results:
 t: Tripping time
 Uc: Contact voltage

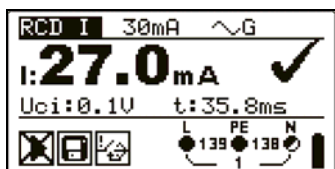

Displayed results:
 IΔ: Tripping current
 Uci: Contact voltage at IΔ
 tI: Tripping time

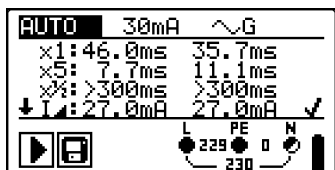

Displayed results:
 Uc: Contact voltage
 x1, x5, x1/2: Tripping times
 IΔ: Tripping current

2.2.5 Loop - Fault loop impedance

Zloop

- High current loop test.
- Very quick and efficient for testing non RCD protected circuits.

Zs rcd

- Low current loop test.
- Multitude of test performed over a longer period of time for increased accuracy.
- Guaranteed not to trip the RCD.

① Set function

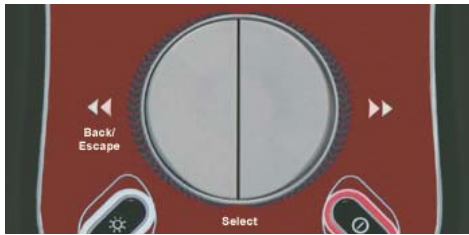

② Set subfunction

- Zloop
- Zs rcd



③ Set parameters and limits

Zloop

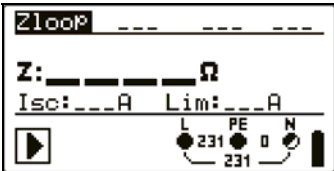

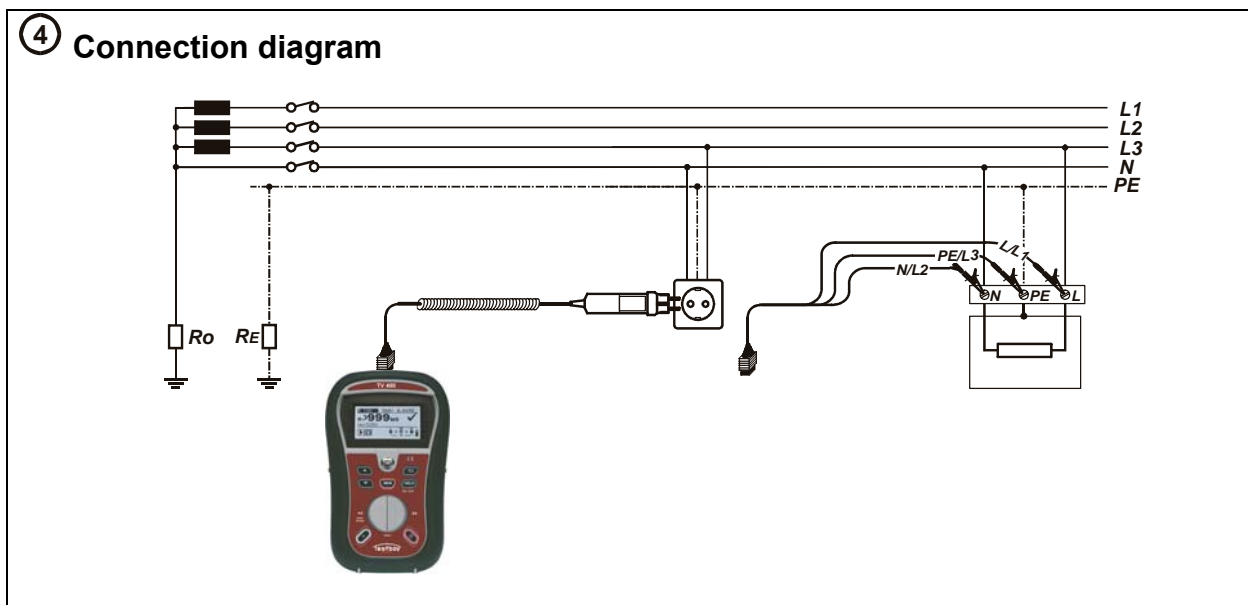

- Fuse type (--- sets limit OFF, NV, gG, B, C, K, D)
- Fuse current rating (0.5 A ÷ 1250 A)
- Fuse tripping time (35 ms, 0.1 s, 0.2 s, 0.4 s, 5 s)

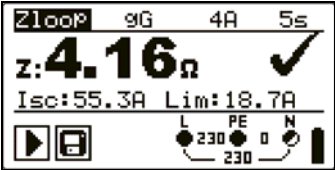
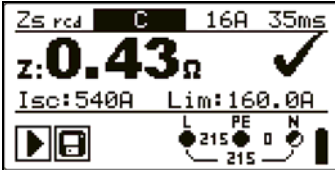

5 Press the  key

6 View results

<p>Zloop</p>  <p>Displayed results: Z: Fault loop impedance Isc: Prospective fault current Lim: High limit fault loop impedance value (if applicable)</p>	<p>Zs rcd</p>  <p>Displayed results: Z: Fault loop impedance Isc: Prospective fault current Lim: High limit fault loop impedance value (if applicable)</p>
--	--

2.2.6 Line impedance - (phase-neutral, phase-phase)

- Used for testing between phases on a single or 3 phase system e.g. testing (L to N, L1 to L2, L2 to L3 etc).

① Set function

② Set parameters and limits

- ❑ Fuse type (--sets limit OFF, NV, gG, B, C, K, D)
- ❑ Fuse current rating (0.5 A ÷ 1250 A)
- ❑ Fuse tripping time (35 ms, 0.1 s, 0.2 s, 0.4 s, 5 s)

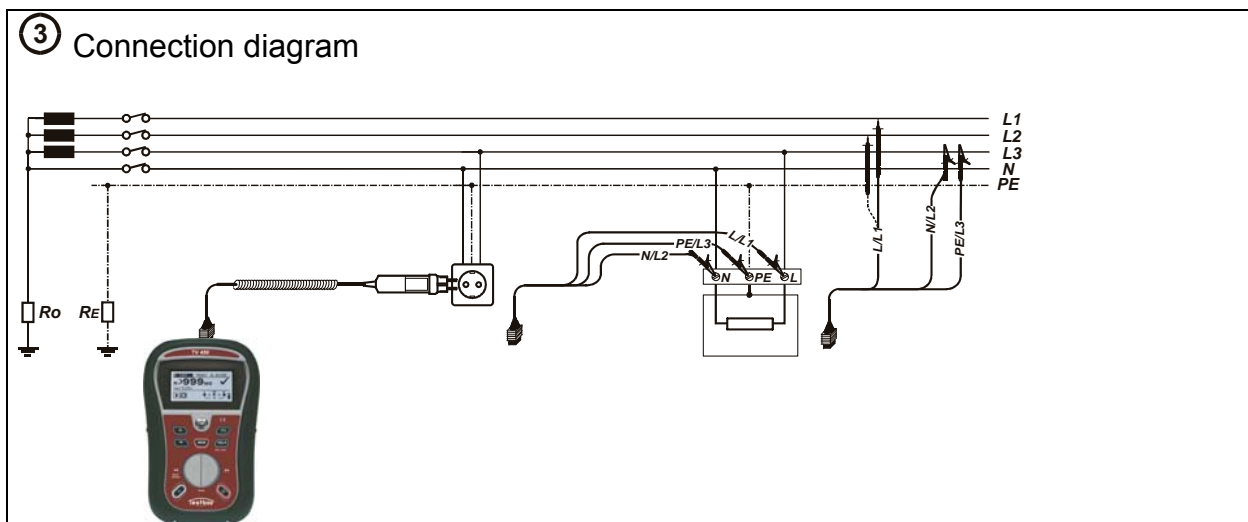

④ Press the  key

⑤ View results

Displayed results:
Z: Line impedance
Isc: Prospective short-circuit current
Lim: High limit line impedance value (if applicable)

2.2.7 Earthing resistance (model TESTBOY TV 450 (Type B))

- Main earthing arrangements, lightning systems, local earthings, etc can be verified with the earthing resistance test.

① Set function



② Set parameters and limits



□ High limit resistance Ω sets limit off, $1 \Omega \div 5 \text{ k}\Omega$

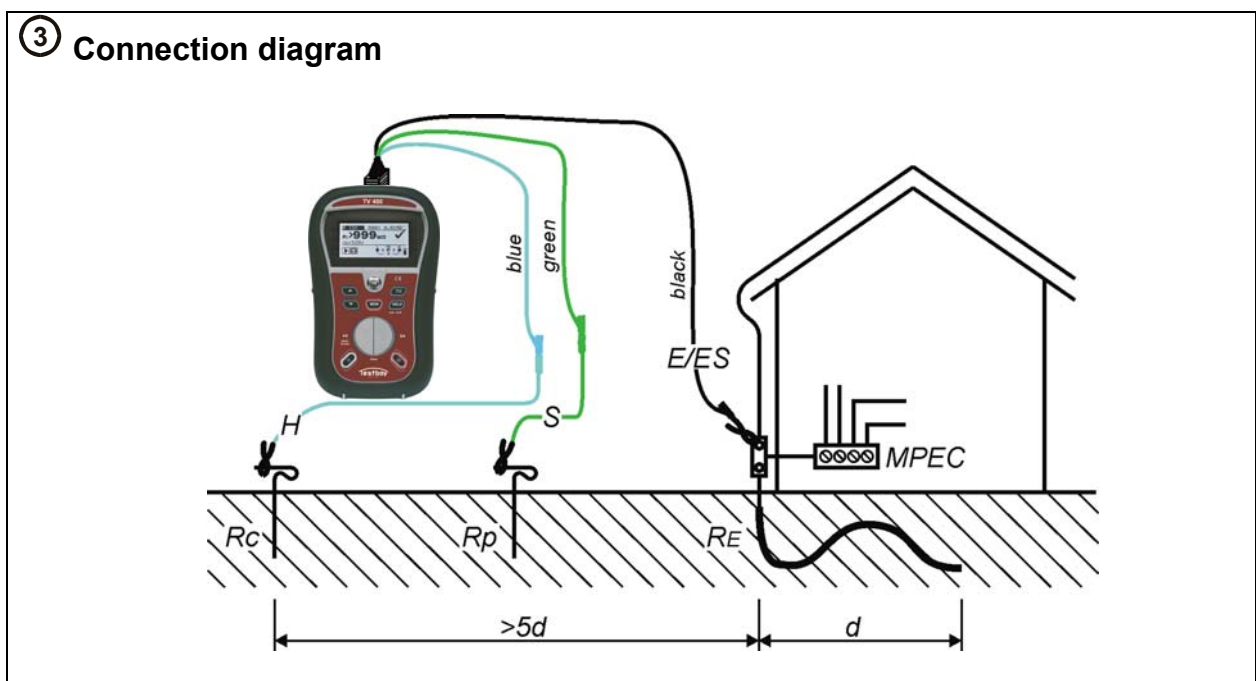

④ Press the  key

⑤ View results



Displayed results:
R: Earth resistance,
Rp: Resistance of S (potential) probe,
Rc: Resistance of H (current) probe.

3 Step by step PC SW installation (model TESTBOY TV 450 (Type B))

TESTBOY TV 450 and TESTBOY TV 450 Plus

1. Insert a CD delivered with the instrument into the CD/DVD drive of your computer.
2. The software should automatically run. If this is not the case, double click on the CD/DVD drive icon on your computer to open the contents of the CD and double click on the "PC SW TV 450.exe" program file.
3. The initial welcome screen will appear, select the language, version and PC SW option.



4. To install the software, Select PC - SW TV 450

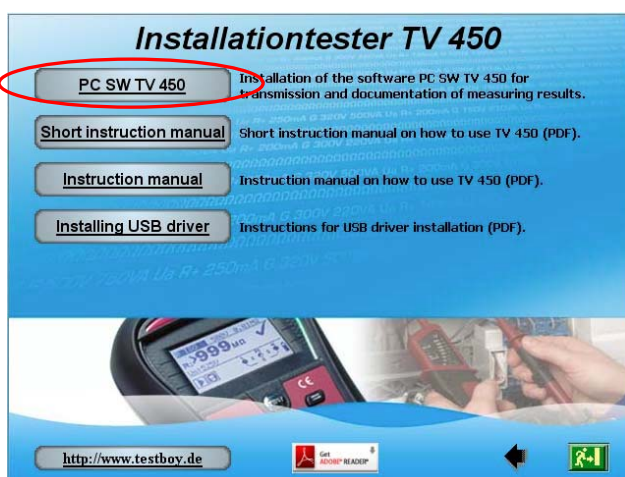

5. The installation of the software will now begin, on the welcome screen Select »Next« and follow the setup instructions

6. After completing the installation, confirm finishing the installation leave the check box ticked to automatically start the program (a shortcut is automatically placed on the desktop and in the start menu for future software initiations).

7. A screen will prompt asking for your password.

a. If you have purchased the TESTBOY TV 450 Plus software, enter your 16 digit code (including dashes), click the ADD button and then OK

b. If you have only purchased the instrument and not the PRO Plus software, simply press cancel or OK on this screen to enter the software.

8. Your TESTBOY TV 450 software will now start up. Help files are available on the software to guide you through the various sections of the software.

9. Select Installing USB /USB installation to install driver.

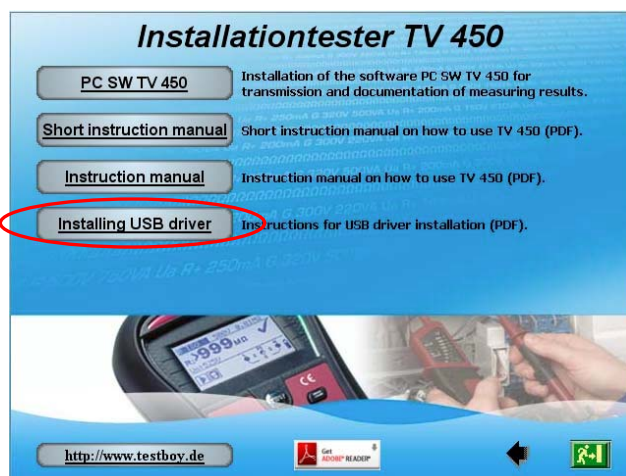

10. Read carefully Installing USB instruction manual available on CD and follow the instruction on how to establish connection between instrument and PC and download the data.