



TESTBOY TV 450
TESTBOY TV 450 (Type B)
Instruction manual
Version 1.5, Code no. 20 751 769

Distributor:

Manufacturer:

Testboy GmbH
Elektrotechnische Spezialfabrik
Beim Alten Flugplatz 3
D - 49377 Vechta

Tel: 0049 (0)4441 / 89112-10
Fax: 0049 (0)4441 / 84536

www.testboy.de
info@testboy.de



Mark on your equipment certifies that this equipment meets the requirements of the EU (European Union) concerning safety and electromagnetic compatibility regulations

© 2009 TESTBOY

No part of this publication may be reproduced or utilized in any form or by any means without permission in writing from TESTBOY.

Table of contents

1	Preface	6
2	Safety and operational considerations.....	7
2.1	Warnings and notes	7
2.2	Battery and charging	10
2.2.1	<i>New battery cells or cells unused for a longer period.....</i>	<i>11</i>
2.3	Standards applied	12
3	Instrument description.....	13
3.1	Front panel	13
3.2	Connector panel	15
3.3	Back side.....	16
3.4	Display organization	17
3.4.1	<i>Terminal voltage monitor.....</i>	<i>17</i>
3.4.2	<i>Battery indication.....</i>	<i>17</i>
3.4.3	<i>Message field.....</i>	<i>17</i>
3.4.4	<i>Result field.....</i>	<i>18</i>
3.4.5	<i>Sound warnings.....</i>	<i>18</i>
3.4.6	<i>Help screens.....</i>	<i>18</i>
3.4.7	<i>Backlight and contrast adjustments.....</i>	<i>19</i>
3.5	Instrument set and accessories.....	20
3.5.1	<i>Standard set TESTBOY TV 450.....</i>	<i>20</i>
3.5.2	<i>Standard set TESTBOY TV 450 (TYPE B).....</i>	<i>20</i>
3.5.3	<i>Optional accessories.....</i>	<i>20</i>
4	Instrument operation.....	21
4.1	Function selection	21
4.2	Settings	22
4.2.1	<i>Language.....</i>	<i>22</i>
4.2.2	<i>Initial settings.....</i>	<i>23</i>
4.2.3	<i>Memory (model TESTBOY TV 450 (TYPE B)).....</i>	<i>24</i>
4.2.4	<i>Date and time (model TESTBOY TV 450 (TYPE B)).....</i>	<i>24</i>
4.2.5	<i>RCD standard.....</i>	<i>25</i>
4.2.6	<i>Isc factor.....</i>	<i>26</i>
4.2.7	<i>Commander support.....</i>	<i>26</i>
5	Measurements	28
5.1	Voltage, frequency and phase sequence	28
5.2	Insulation resistance.....	30
5.3	Resistance of earth connection and equipotential bonding	32
5.3.1	<i>R LOWΩ, 200 mA resistance measurement.....</i>	<i>33</i>
5.3.2	<i>Continuous resistance measurement with low current (model TESTBOY TV 450 (TYPE B)).....</i>	<i>34</i>
5.3.3	<i>Compensation of test leads resistance.....</i>	<i>35</i>
5.4	Testing RCDs	36
5.4.1	<i>Contact voltage (RCD U_c).....</i>	<i>37</i>
5.4.2	<i>Trip-out time (RCD t).....</i>	<i>38</i>
5.4.3	<i>Trip-out current (RCD I).....</i>	<i>39</i>

5.4.4	<i>RCD Autotest</i>	40
5.5	Fault loop impedance and prospective fault current	43
5.6	Line impedance and prospective short-circuit current	45
5.7	Earth resistance (model TESTBOY TV 450 (TYPE B))	47
5.8	PE test terminal	49
6	Data handling (model TESTBOY TV 450 (TYPE B))	51
6.1	Memory organization	51
6.2	Data structure	51
6.3	Storing test results	53
6.4	Recalling test results	54
6.5	Clearing stored data	55
6.5.1	<i>Clearing complete memory content</i>	55
6.5.2	<i>Clearing measurement(s) in selected location</i>	55
6.5.3	<i>Clearing individual measurements</i>	56
6.5.4	<i>Renaming installation structure elements</i>	57
6.6	Communication	58
7	Upgrading the instrument	59
8	Maintenance	60
8.1	Fuse replacement	60
8.2	Cleaning	60
8.3	Periodic calibration	60
8.4	Service	60
9	Technical specifications	61
9.1	Insulation resistance	61
9.2	Continuity	62
9.2.1	<i>Resistance R LOWΩ</i>	62
9.2.2	<i>Resistance CONTINUITY (model TESTBOY TV 450 (TYPE B))</i>	62
9.3	RCD testing	62
9.3.1	<i>General data</i>	62
9.3.2	<i>Contact voltage RCD-U_c</i>	63
9.3.3	<i>Trip-out time</i>	63
9.3.4	<i>Trip-out current</i>	63
9.4	Fault loop impedance and prospective fault current	64
9.4.1	<i>No disconnecting device or FUSE selected</i>	64
9.4.2	<i>RCD selected</i>	65
9.5	Line impedance and prospective short-circuit current	65
9.6	Resistance to earth (model TESTBOY TV 450 (TYPE B))	66
9.7	Voltage, frequency, and phase rotation	66
9.7.1	<i>Phase rotation</i>	66
9.7.2	<i>Voltage</i>	66
9.7.3	<i>Frequency</i>	66
9.7.4	<i>Online terminal voltage monitor</i>	67
9.8	General data	67
A	Appendix A - Fuse table	68
A.1	Fuse table - IPSC	68
A.2	Fuse table - impedances (UK)	70

B	Appendix B - Accessories for specific measurements	72
C	Appendix F – Country notes	73
C.1	List of country modifications	73
C.2	Modification issues	73
C.2.1	<i>AT modification - G type RCD</i>	<i>73</i>

1 Preface

Congratulations on your purchase of the TESTBOY instrument and its accessories from TESTBOY. The instrument was designed on a basis of rich experience, acquired through many years of dealing with electric installation test equipment.

The TESTBOY instrument is professional, multifunctional, hand-held test instrument intended to perform all the measurements required in order for a total inspection of electrical installations in buildings. The following measurements and tests can be performed:

In the models TESTBOY TV 450 and TESTBOY TV 450B

- Voltage and frequency,
- Continuity tests,
- Insulation resistance tests,
- RCD testing,
- Fault loop / RCD trip-lock impedance measurements,
- Line impedance,
- Phase sequence,

Additionally, model TESTBOY TV 450 (Type B) includes:

- Earthing resistance tests

The graphic display with backlight offers easy reading of results, indications, measurement parameters and messages. Two LED Pass/Fail indicators are placed at the sides of the LCD.

The operation of the instrument is designed to be as simple and clear as possible and no special training (except for the reading this instruction manual) is required in order to begin using the instrument.

In order for operator to be familiar enough with performing measurements in general and their typical applications it is advisable to read TESTBOY handbook *Guide for testing and verification of low voltage installations*.

The instrument is equipped with the entire necessary accessory for comfortable testing.

2 Safety and operational considerations

2.1 Warnings and notes

In order to maintain the highest level of operator safety while carrying out various tests and measurements, TESTBOY recommends keeping your TESTBOY instruments in good condition and undamaged. When using the instrument, consider the following general warnings:

- ❑ The  symbol on the instrument means »Read the Instruction manual with special care for safe operation«. The symbol requires an action!
- ❑ If the test equipment is used in a manner not specified in this user manual, the protection provided by the equipment could be impaired!
- ❑ Read this user manual carefully, otherwise the use of the instrument may be dangerous for the operator, the instrument or for the equipment under test!
- ❑ Do not use the instrument or any of the accessories if any damage is noticed!
- ❑ If a fuse blows in the instrument, follow the instructions in this manual in order to replace it!
- ❑ Consider all generally known precautions in order to avoid risk of electric shock while dealing with hazardous voltages!
- ❑ Do not use the instrument in supply systems with voltages higher than 550 V!
- ❑ Service intervention or adjustment is only allowed to be carried out by a competent authorized personnel!
- ❑ Use only standard or optional test accessories supplied by your distributor!
- ❑ Consider that older accessories and some of the new optional test accessories compatible with this instrument only meet CAT III / 300 V overvoltage safety rating! This means that maximal allowed voltage between test terminals and ground is 300 V!
- ❑ The instrument comes supplied with rechargeable Ni-Cd or Ni-MH battery cells. The cells should only be replaced with the same type as defined on the battery compartment label or as described in this manual. Do not use standard alkaline battery cells while the power supply adapter is connected, otherwise they may explode!
- ❑ Hazardous voltages exist inside the instrument. Disconnect all test leads, remove the power supply cable and switch off the instrument before
- ❑ All normal safety precautions must be taken in order to avoid risk of electric shock while working on electrical installations!

Warnings related to measurement functions:

Insulation resistance

- ❑ Insulation resistance measurement should only be performed on de-energized objects!
- ❑ Do not touch the test object during the measurement or before it is fully discharged! Risk of electric shock!
- ❑ When an insulation resistance measurement has been performed on a capacitive object, automatic discharge may not be done immediately! The warning message  and the actual voltage is displayed during discharge until voltage drops below 10 V.
- ❑ Do not connect test terminals to external voltage higher than 600 V (AC or DC) in order not to damage the test instrument!

Continuity functions

- ❑ Continuity measurements should only be performed on de-energized objects!
- ❑ Parallel impedances or transient currents may influence test results.

Testing PE terminal

- ❑ If phase voltage is detected on the tested PE terminal, stop all measurements immediately and ensure the cause of the fault is eliminated before proceeding with any activity!

Notes related to measurement functions:

General

- ❑ The  indicator means that the selected measurement cannot be performed because of irregular conditions on input terminals.
- ❑ Insulation resistance, continuity functions and earth resistance measurements (TESTBOY TV 450 (TYPE B)) can only be performed on de-energized objects.
- ❑ PASS / FAIL indication is enabled when limit is set. Apply appropriate limit value for evaluation of measurement results.
- ❑ In the case that only two of the three wires are connected to the electrical installation under test, only voltage indication between these two wires is valid.

Insulation resistance

- ❑ If voltages of higher than 10 V (AC or DC) is detected between test terminals, the insulation resistance measurement will not be performed. If voltages of higher than 10 V (AC or DC) is detected between test terminals, the insulation resistance measurement will not be performed.
- ❑ The instrument automatically discharge tested object after finished measurement.
- ❑ A double click of TEST key starts a continuous measurement.

Continuity functions

- ❑ If voltages of higher than 10 V (AC or DC) is detected between test terminals, the continuity resistance test will not be performed.
- ❑ Before performing a continuity measurement, where necessary, compensate test lead resistance.

RCD functions

- ❑ Parameters set in one function are also kept for other RCD functions!
- ❑ The measurement of contact voltage does not normally trip an RCD. However, the trip limit of the RCD may be exceeded as a result of leakage current flowing to the PE protective conductor or a capacitive connection between L and PE conductors.
- ❑ The RCD trip-lock sub-function (function selector switch in LOOP position) takes longer to complete but offers much better accuracy of fault loop resistance (in comparison to the R_L sub-result in Contact voltage function).
- ❑ RCD trip-out time and RCD trip-out current measurements will only be performed if the contact voltage in the pre-test at nominal differential current is lower than the set contact voltage limit!
- ❑ The autotest sequence (RCD AUTO function) stops when trip-out time is out of allowable time period.

Z-LOOP

- ❑ The low limit prospective short-circuit current value depends on fuse type, fuse current rating, fuse trip-out time and impedance scaling factor.
- ❑ The specified accuracy of tested parameters is valid only if the mains voltage is stable during the measurement.
- ❑ Fault loop impedance measurements will trip an RCD.
- ❑ The measurement of fault loop impedance using trip-lock function does not normally trip an RCD. However, the trip limit may be exceeded as a result of leakage current flowing to the PE protective conductor or a capacitive connection between L and PE conductors.

Z-LINE

- ❑ In case of measurement of $Z_{\text{Line-Line}}$ with the instrument test leads PE and N connected together the instrument will display a warning of dangerous PE voltage. The measurement will be performed anyway.
- ❑ Specified accuracy of tested parameters is valid only if mains voltage is stable during the measurement.
- ❑ L and N test terminals are reversed automatically according to detected terminal voltage (except in UK version).

2.2 Battery and charging

The instrument uses six AA size alkaline or rechargeable Ni-Cd or Ni-MH battery cells. Nominal operating time is declared for cells with nominal capacity of 2100 mAh.

Battery condition is always displayed in the lower right display part.

In case the battery is too weak the instrument indicates this as shown in figure 2.1. This indication appears for a few seconds and then the instrument turns itself off.

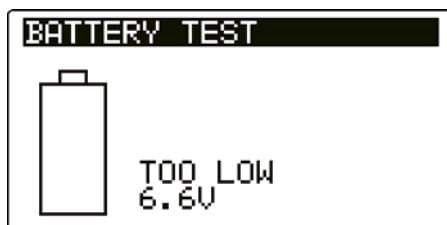

Figure 2.1: Discharged battery indication

The battery is charged whenever the power supply adapter is connected to the instrument. The power supply socket polarity is shown in figure 2.2. Internal circuit controls charging and assures maximum battery lifetime.



Figure 2.2: Power supply socket polarity

The instrument automatically recognizes the connected power supply adapter and begins charging.

Symbols:

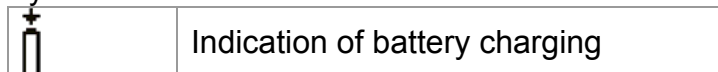

Figure 2.3: Charging indication

- ❑ When connected to an installation, the instruments battery compartment can contain hazardous voltage inside! When replacing battery cells or before opening the battery/fuse compartment cover, disconnect any measuring accessory connected to the instrument and turn off the instrument,
- ❑ Ensure that the battery cells are inserted correctly otherwise the instrument will not operate and the batteries could be discharged.
- ❑ If the instrument is not to be used for a long period of time, remove all batteries from the battery compartment.
- ❑ Alkaline or rechargeable Ni-Cd or Ni-MH batteries (size AA) can be used. TESTBOY recommends only using rechargeable batteries with a capacity of 2100mAh or above.
- ❑ Do not recharge alkaline battery cells!
- ❑ Use only power supply adapter delivered from the manufacturer or distributor of the test equipment to avoid possible fire or electric shock!

2.2.1 New battery cells or cells unused for a longer period

Unpredictable chemical processes can occur during the charging of new battery cells or cells that have been left unused for a longer period (more than 3 months). Ni-MH and Ni-Cd cells can be subjected to these chemical effects (sometimes called the memory effect). As a result the instrument operation time can be significantly reduced during the initial charging/discharging cycles of the batteries.

In this situation, TESTBOY recommend the following procedure to improve the battery lifetime:

Procedure	Notes
➤ Completely charge the battery.	At least 14h with in-built charger.
➤ Completely discharge the battery.	This can be performed by using the instrument normally until the instrument is fully discharged.
➤ Repeat the charge / discharge cycle at least 2-4 times.	Four cycles are recommended in order to restore the batteries to their normal capacity.

Notes:

- ❑ The charger in the instrument is a pack cell charger. This means that the battery cells are connected in series during the charging. The battery cells have to be equivalent (same charge condition, same type and age).
- ❑ One different battery cell can cause an improper charging and incorrect discharging during normal usage of the entire battery pack (it results in heating of the battery pack, significantly decreased operation time, reversed polarity of defective cell,...).
- ❑ If no improvement is achieved after several charge / discharge cycles, then each battery cell should be checked (by comparing battery voltages, testing them in a cell charger, etc). It is very likely that only some of the battery cells are deteriorated.
- ❑ The effects described above should not be confused with the normal decrease of battery capacity over time. Battery also loses some capacity when it is repeatedly charged / discharged. Actual decreasing of capacity, versus number of charging cycles, depends on battery type. This information is provided in the technical specification from battery manufacturer.

2.3 Standards applied

The TESTBOY instruments are manufactured and tested in accordance with the following regulations:

Electromagnetic compatibility (EMC)

EN 61326	Electrical equipment for measurement, control and laboratory use – EMC requirements Class B (Hand-held equipment used in controlled EM environments)
----------	---

Safety (LVD)

EN 61010-1	Safety requirements for electrical equipment for measurement, control and laboratory use – Part 1: General requirements
EN 61010-031	Safety requirements for hand-held probe assemblies for electrical measurement and test
EN 61010-2-032	Safety requirements for electrical equipment for measurement, control, and laboratory use - Part 2-032: Particular requirements for hand-held and hand-manipulated current sensors for electrical test and measurement

Functionality

EN 61557	Electrical safety in low voltage distribution systems up to 1000 V _{AC} and 1500 V _{AC} – Equipment for testing, measuring or monitoring of protective measures Part 1 General requirements Part 2 Insulation resistance Part 3 Loop resistance Part 4 Resistance of earth connection and equipotential bonding Part 5 Resistance to earth (TESTBOY TV 450 (TYPE B) only) Part 6 Residual current devices (RCDs) in TT and TN systems Part 7. Phase sequence Part 10 Combined measuring equipment
----------	---

Other reference standards for testing RCDs

EN 61008	Residual current operated circuit-breakers without integral overcurrent protection for household and similar uses
EN 61009	Residual current operated circuit-breakers with integral overcurrent protection for household and similar uses
EN 60364-4-41	Electrical installations of buildings Part 4-41 Protection for safety – protection against electric shock
BS 7671	IEE Wiring Regulations (17 th edition)
AS / NZ 3760	In-service safety inspection and testing of electrical equipment

Note about EN and IEC standards:

- Text of this manual contains references to European standards. All standards of EN 6XXXX (e.g. EN 61010) series are equivalent to IEC standards with the same number (e.g. IEC 61010) and differ only in amended parts required by European harmonization procedure.

3 Instrument description

3.1 Front panel



Figure 3.1: Front panel (picture of TESTBOY TV 450 (TYPE B))

Legend:

* Model TESTBOY TV 450 (TYPE B)

** Model TESTBOY TV 450

1	LCD	128 x 64 dots matrix display with backlight.
2	TEST	TEST Starts measurements. Acts also as the PE touching electrode.
3	UP	Modifies selected parameter.
4	DOWN	Modifies selected parameter.
5*	MEM	Store / recall / clear tests in memory of instrument.
5**	CAL	Calibrates test leads in Continuity functions.
6	Function selectors	Selects test function.
7	Backlight, Contrast	Changes backlight level and contrast.
8	ON / OFF	Switches the instrument power on or off. <i>The instrument automatically turns off 15 minutes after the last key was pressed.</i>
9*	HELP / CAL	Accesses help menus. In RCD Auto toggles between top and bottom parts of results field.
		Calibrates test leads in Continuity functions.

9**	HELP	Accesses help menus. In RCD Auto toggles between top and bottom parts of results field.
10	TAB	Selects the parameters in selected function.
11	PASS	Green indicator
12	FAIL	Red indicator

3.2 Connector panel

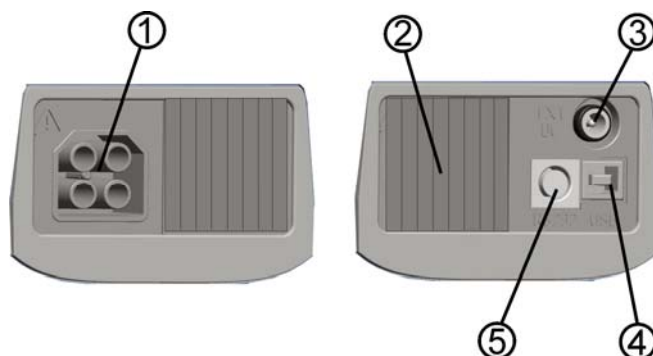

Figure 3.2: Connector panel (picture of TESTBOY TV 450 (TYPE B))

Legend:

* Model TESTBOY TV 450 (TYPE B)

** Model TESTBOY TV 450

1	Test connector	Measuring inputs / outputs
2	Protection cover	
3	Charger socket	
4*	USB connector	Communication with PC USB (1.1) port.
5*	PS/2 connector	Communication with PC serial port and connection to optional measuring adapters.
5**	PS/2 connector	Serial port for upgrading the instrument.

Warnings!

- ❑ **Maximum allowed voltage between any test terminal and ground is 600 V!**
- ❑ **Maximum allowed voltage between test terminals is 600 V!**
- ❑ **Maximum short-term voltage of external power supply adapter is 14 V!**

3.3 Back side



Figure 3.3: Back side

Legend:

1	Side belt
2	Battery compartment cover
3	Fixing screw for battery compartment cover
4	Back panel information label
5	Holder for inclined position of the instrument
6	Magnet for fixing instrument close to tested item (optional)

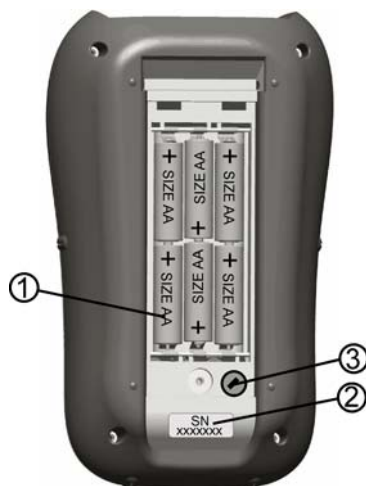

Figure 3.4: Battery compartment

Legend:

1	Battery cells	Size AA, alkaline or rechargeable NiMH / NiCd
2	Serial number label	
3	Fuse	M 0.315 A, 250 V

3.4 Display organization

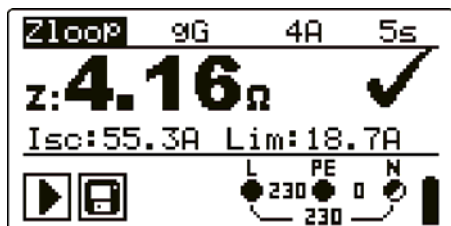

Figure 3.5: Typical function display

Zloop	Function name
z: 4.16 Ω ✓ Isc: 55.3A Lim: 18.7A	Result field
9G 4A 5s	Test parameter field
[Play] [Battery]	Message field
L PE N ● 230 ● 0 ● └─ 230 ─┘	Terminal voltage monitor
[Battery]	Battery indication

3.4.1 Terminal voltage monitor

The terminal voltage monitor displays on-line the voltages on the test terminals and information about active test terminals.



Online voltages are displayed together with test terminal indication. All three test terminals are used for selected measurement.



Online voltages are displayed together with test terminal indication. L and N test terminals are used for selected measurement.

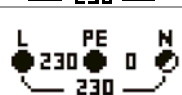

L and PE are active test terminals; N terminal should also be connected for correct input voltage condition.

3.4.2 Battery indication

The indication indicates the charge condition of battery and connection of external charger .



Battery capacity indication.



Low battery.
Battery is too weak to guarantee correct result. Replace or recharge the battery cells.



Recharging in progress (if power supply adapter is connected).

3.4.3 Message field

In the message field warnings and messages are displayed.













Measurement is running, consider displayed warnings.





Conditions on the input terminals allow starting the measurement; consider other displayed warnings and messages.



Conditions on the input terminals do not allow starting the measurement, consider displayed warnings and messages.

	RCD tripped-out during the measurement (in RCD functions).
	Instrument is overheated. The measurement is prohibited until the temperature decreases under the allowed limit.
	Result(s) can be stored. (model TESTBOY TV 450 (TYPE B))
	High electrical noise was detected during measurement. Results may be impaired.
	L and N are changed.
	Warning! High voltage is applied to the test terminals.
	Warning! Dangerous voltage on the PE terminal! Stop the activity immediately and eliminate the fault / connection problem before proceeding with any activity!
	Test leads resistance in Continuity measurement is not compensated.
	Test leads resistance in Continuity measurement is compensated.
	High resistance to earth of test probes. Results may be impaired. (model TESTBOY TV 450 (TYPE B))

3.4.4 Result field

	Measurement result is inside pre-set limits (PASS).
	Measurement result is out of pre-set limits (FAIL).
	Measurement is aborted. Consider displayed warnings and messages.

3.4.5 Sound warnings

Continuous sound **Warning!** Dangerous voltage on the PE terminal is detected.

3.4.6 Help screens

HELP	Opens help screen.
-------------	--------------------

Help menus are available in all functions. The Help menu contains schematic diagrams for illustrating how to properly connect the instrument to electric installation. After selecting the measurement you want to perform, press the HELP key in order to view the associated Help menu.

Keys in help menu:

UP / DOWN	Selects next / previous help screen.
HELP	Scrolls through help screens.
Function selectors / TEST	Exits help menu.

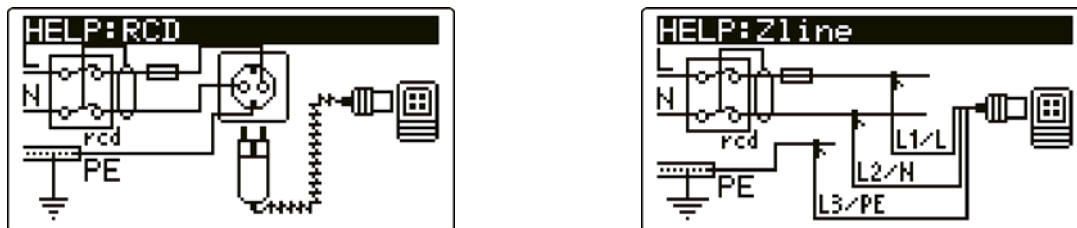

Figure 3.6: Examples of help screens

3.4.7 Backlight and contrast adjustments

With the **BACKLIGHT** key backlight and contrast can be adjusted.

Click	Toggles backlight intensity level.
Keep pressed for 1 s	Locks high intensity backlight level until power is turned off or the key is pressed again.
Keep pressed for 2 s	Bargraph for LCD contrast adjustment is displayed.

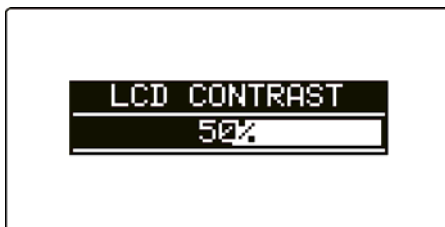

Figure 3.7: Contrast adjustment menu

Keys for contrast adjustment:

DOWN	Reduces contrast.
UP	Increases contrast.
TEST	Accepts new contrast.
Function selectors	Exits without changes.

3.5 Instrument set and accessories

3.5.1 Standard set TESTBOY TV 450

- Instrument
- Short instruction manual
- Calibration Certificate
- Mains measuring cable
- Test lead. 3 x 1.5 m
- Test probe. 3 pcs
- Crocodile clip. 3 pcs
- Set of NiMH battery cells
- Power supply adapter
- CD with instruction manual, and “Guide for testing and verification of low voltage installations” handbook.
- Set of carrying straps

3.5.2 Standard set TESTBOY TV 450 (TYPE B)

- Instrument
- Short instruction manual
- Calibration Certificate
- Mains measuring cable
- Test lead. 3 x 1.5 m
- Test probe. 3 pcs
- Crocodile clip. 3 pcs
- Set of NiMH battery cells
- Power supply adapter
- CD with instruction manual, and “Guide for testing and verification of low voltage installations” handbook and PC software TESTBOY TV 450
- Set of carrying straps
- RS232 - PS/2 cable
- USB cable

3.5.3 Optional accessories

See the attached sheet for a list of optional accessories that are available on request from your distributor.

4 Instrument operation

4.1 Function selection

For selecting test function the **FUNCTION SELECTOR** shall be used.

Keys:

FUNCTION SELECTOR	Select test / measurement function: <ul style="list-style-type: none"> <input type="checkbox"/> <VOLTAGE TRMS> Voltage and frequency and phase sequence. <input type="checkbox"/> <R ISO> Insulation resistance. <input type="checkbox"/> <R LOWΩ> Resistance of earth connections and bondings. <input type="checkbox"/> <Zline> Line impedance. <input type="checkbox"/> <Zloop> Fault loop impedance. <input type="checkbox"/> <RCD> RCD testing. <input type="checkbox"/> <EARTH RE> Resistance to earth (model TESTBOY TV 450 (TYPE B)). <input type="checkbox"/> <SETTINGS> General instrument settings.
UP/DOWN	Selects sub-function in selected measurement function.
TAB	Selects the test parameter to be set or modified.
TEST	Runs selected test / measurement function.
MEM	Stores measured results / recalls stored results (model TESTBOY TV 450 (TYPE B)).

Keys in **test parameter** field:

UP/DOWN	Changes the selected parameter.
TAB	Selects the next measuring parameter.
FUNCTION SELECTOR	Toggles between the main functions.
MEM	Stores measured results / recalls stored results (model TESTBOY TV 450 (TYPE B)).

General rule regarding enabling **parameters** for evaluation of measurement / test result:

Parameter	OFF	No limit values, indication: <u> </u> .
	ON	Value(s) – results will be marked as PASS or FAIL in accordance with selected limit.

See *Chapter 5* for more information about the operation of the instrument test functions.

4.2 Settings

Different instrument options can be set in the **SETTINGS** menu.

Options in both models are:

- Selection of language,
- Setting the instrument to initial values,
- Selection of reference standard for RCD test,
- Entering Isc factor,
- Commander support.

Additional options in model TESTBOY TV 450 (TYPE B) are:

- Recalling and clearing stored results,
- Setting the date and time,

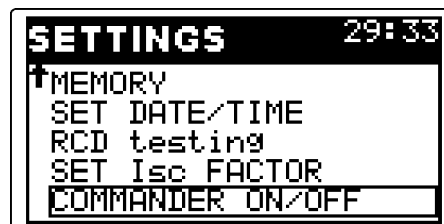

Figure 4.1: Options in Settings menu

Keys:

UP / DOWN	Selects appropriate option.
TEST	Enters selected option.
Function selectors	Exits back to main function menu.

4.2.1 Language

In this menu the language can be set.



Figure 4.2: Language selection

Keys:

UP / DOWN	Selects language.
TEST	Confirms selected language and exits to settings menu.
Function selectors	Exits back to main function menu.

4.2.2 Initial settings

In this menu the instrument settings and measurement parameters and limits can be set to initial (factory) values.



Figure 4.3: Initial settings dialogue

Keys:

TEST	Restores default settings.
Function selectors	Exits back to main function menu without changes.

Warning:

- Customized settings will be lost when this option is used!
- If the batteries are removed for more than 1 minute the custom made settings will be lost.

The default setup is listed below:

* model TESTBOY TV 450 (TYPE B)

Instrument setting	Default value
Contrast	As defined and stored by adjustment procedure
Isc factor	1.00
RCD standards	EN 61008 / EN 61009
Language	English
Commander	Enabled

Function Sub-function	Parameters / limit value
EARTH RE*	No limit
R ISO	No limit U _{test} = 500 V
Low Ohm Resistance R LOWΩ CONTINUITY*	No limit No limit
Z - LINE	Fuse type: none selected
Z - LOOP	Fuse type: none selected
Zs _{rcd}	Fuse type: none selected
RCD	RCD t Nominal differential current: I _{ΔN} =30 mA RCD type: G Test current starting polarity:  (0°) Limit contact voltage: 50 V Current multiplier: ×1

Note:

- Initial settings (reset of the instrument) can be recalled also if the TAB key is pressed while the instrument is switched on.

4.2.3 Memory (model TESTBOY TV 450 (TYPE B))

In this menu the stored data can be recalled and deleted. See chapter 6 *Data handling* for more information.

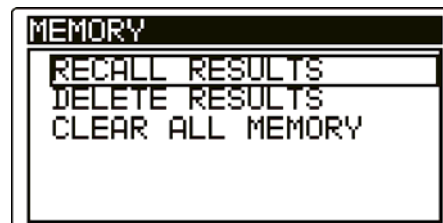

Figure 4.4: Memory options

Keys:

UP / DOWN	Selects option.
TEST	Enters selected option.
Function selectors	Exits back to main function menu.

4.2.4 Date and time (model TESTBOY TV 450 (TYPE B))

In this menu date and time can be set.



Figure 4.5: Setting date and time

Keys:

TAB	Selects the field to be changed.
UP / DOWN	Modifies selected field.
TEST	Confirms new setup and exits.
Function selectors	Exits back to main function menu.

Warning:

- If the batteries are removed for more than 1 minute the set time and date will be lost.

4.2.5 RCD standard

In this menu the used standard for RCD tests can be set.

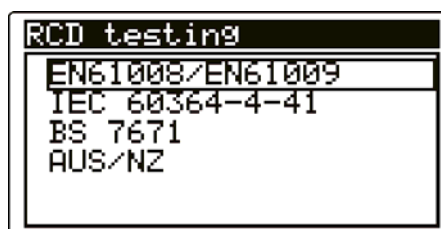

Figure 4.6: Selection of RCD test standard

Keys:

UP / DOWN	Selects standard.
TEST	Confirms selected standard.
Function selectors	Exits back to main function menu.

Maximum RCD disconnection times differ in various standards.
The trip-out times defined in individual standards are listed below.

Trip-out times according to EN 61008 / EN 61009:

	$\frac{1}{2} \times I_{\Delta N}^{*)}$	$I_{\Delta N}$	$2 \times I_{\Delta N}$	$5 \times I_{\Delta N}$
General RCDs (non-delayed)	$t_{\Delta} > 300$ ms	$t_{\Delta} < 300$ ms	$t_{\Delta} < 150$ ms	$t_{\Delta} < 40$ ms
Selective RCDs (time-delayed)	$t_{\Delta} > 500$ ms	130 ms $< t_{\Delta} < 500$ ms	60 ms $< t_{\Delta} < 200$ ms	50 ms $< t_{\Delta} < 150$ ms

Trip-out times according to EN 60364-4-41:

	$\frac{1}{2} \times I_{\Delta N}^{*)}$	$I_{\Delta N}$	$2 \times I_{\Delta N}$	$5 \times I_{\Delta N}$
General RCDs (non-delayed)	$t_{\Delta} > 999$ ms	$t_{\Delta} < 999$ ms	$t_{\Delta} < 150$ ms	$t_{\Delta} < 40$ ms
Selective RCDs (time-delayed)	$t_{\Delta} > 999$ ms	130 ms $< t_{\Delta} < 999$ ms	60 ms $< t_{\Delta} < 200$ ms	50 ms $< t_{\Delta} < 150$ ms

Trip-out times according to BS 7671:

	$\frac{1}{2} \times I_{\Delta N}^{*)}$	$I_{\Delta N}$	$2 \times I_{\Delta N}$	$5 \times I_{\Delta N}$
General RCDs (non-delayed)	$t_{\Delta} > 1999$ ms	$t_{\Delta} < 300$ ms	$t_{\Delta} < 150$ ms	$t_{\Delta} < 40$ ms
Selective RCDs (time-delayed)	$t_{\Delta} > 1999$ ms	130 ms $< t_{\Delta} < 500$ ms	60 ms $< t_{\Delta} < 200$ ms	50 ms $< t_{\Delta} < 150$ ms

Trip-out times according to AS/NZ^{**}):

RCD type	$I_{\Delta N}$ [mA]	$\frac{1}{2} \times I_{\Delta N}^{*)}$ t_{Δ}	$I_{\Delta N}$ t_{Δ}	$2 \times I_{\Delta N}$ t_{Δ}	$5 \times I_{\Delta N}$ t_{Δ}	Note
I	≤ 10	> 999 ms	40 ms	40 ms	40 ms	Maximum break time
II	$> 10 \leq 30$		300 ms	150 ms	40 ms	
III	> 30		300 ms	150 ms	40 ms	
IV \square	> 30	> 999 ms	500 ms	200 ms	150 ms	Minimum non-actuating time
			130 ms	60 ms	50 ms	

^{*)} Minimum test period for current of $\frac{1}{2} \times I_{\Delta N}$, RCD shall not trip-out.

^{**)} Test current and measurement accuracy correspond to AS/NZ requirements.

Maximum test times related to selected test current for general (non-delayed) RCD

Standard	$\frac{1}{2} \times I_{\Delta N}$	$I_{\Delta N}$	$2 \times I_{\Delta N}$	$5 \times I_{\Delta N}$
EN 61008 / EN 61009	300 ms	300 ms	150 ms	40 ms
EN 60364-4-41	1000 ms	1000 ms	150 ms	40 ms
BS 7671	2000 ms	300 ms	150 ms	40 ms
AS/NZ (I, II, III)	1000 ms	1000 ms	150 ms	40 ms

Maximum test times related to selected test current for selective (time-delayed) RCD

Standard	$\frac{1}{2} \times I_{\Delta N}$	$I_{\Delta N}$	$2 \times I_{\Delta N}$	$5 \times I_{\Delta N}$
EN 61008 / EN 61009	500 ms	500 ms	200 ms	150 ms
EN 60364-4-41	1000 ms	1000 ms	200 ms	150 ms
BS 7671	2000 ms	500 ms	200 ms	150 ms
AS/NZ (IV)	1000 ms	1000 ms	200 ms	150 ms

4.2.6 Isc factor

In this menu the Isc factor for calculation of short circuit current in Z-LINE and Z-LOOP measurements can be set.

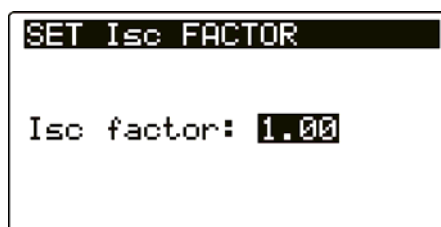

Figure 4.7: Selection of Isc factor

Keys:

UP / DOWN	Sets Isc value.
TEST	Confirms Isc value.
Function selectors	Exits back to main function menu.

Short circuit current Isc in the supply system is important for selection or verification of protective circuit breakers (fuses, over-current breaking devices, RCDs). The default value of Isc factor (ksc) is 1.00. The value should be set according to local regulative.

Range for adjustment of the Isc factor is 0.20 ÷ 3.00.

4.2.7 Commander support

The support for remote commanders can be switched On/ Off in this menu.

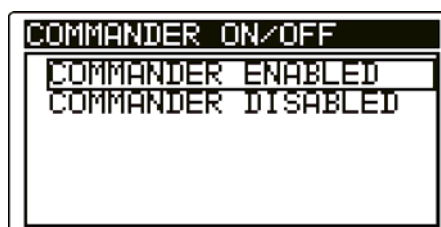

Figure 4.8: Selection of commander support

Keys:

UP / DOWN	Selects commander option.
TEST	Confirms selected option.
Function selectors	Exits back to main function menu.

Note:

- This option is intended to disable the commander's remote keys. In the case of high EM interfering noise the operation of the commander's key can be irregular.

5 Measurements

5.1 Voltage, frequency and phase sequence

Voltage and frequency measurement is always active in the terminal voltage monitor. In the special **VOLTAGE TRMS** menu the measured voltage, frequency and information about detected three-phase connection can be stored. Phase sequence measurement conforms to the EN 61557-7 standard.

See chapter 4.1 *Function selection* for instructions on key functionality.

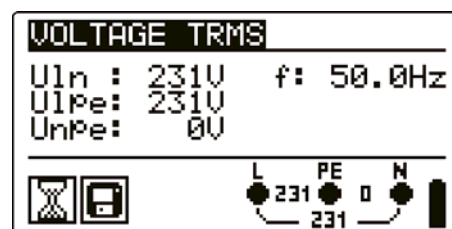

Figure 5.1: Voltage in single phase system

Test parameters for voltage measurement

There are no parameters to set.

Connections for voltage measurement

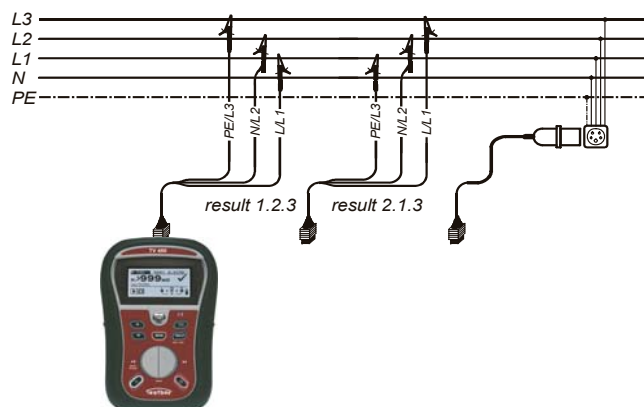

Figure 5.2: Connection of 3-wire test lead and optional adapter in three-phase system

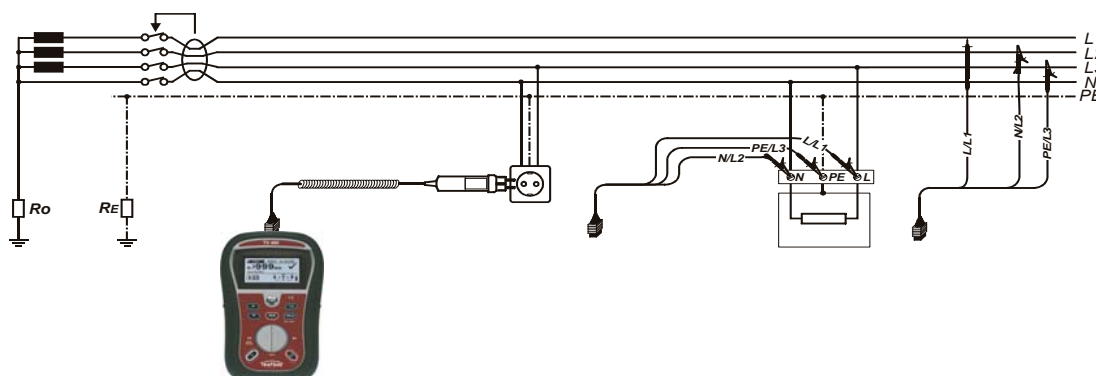

Figure 5.3: Connection of plug commander and 3-wire test lead in single-phase system

Voltage measurement procedure

* model TESTBOY TV 450 (TYPE B)

- Select the **VOLTAGE TRMS** function using the function selector switch.
- **Connect** test cable to the instrument.
- **Connect** test leads to the item to be tested (see *figures 5.2 and 5.3*).
- **Store** current measurement result by pressing the MEM key (optional)*.

Measurement runs immediately after selection of **VOLTAGE TRMS** function.

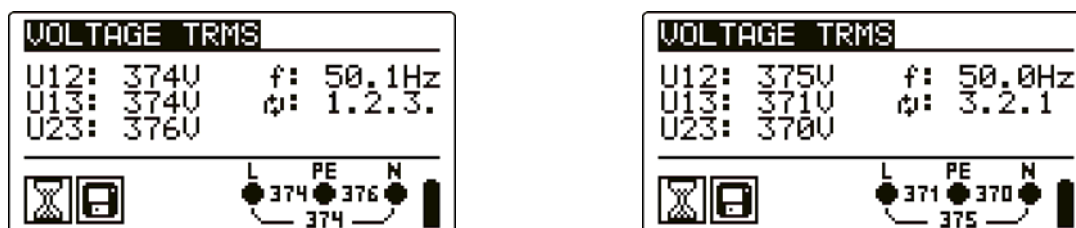

Figure 5.4: Examples of voltage measurement in three-phase system

Displayed results for single phase system:

U_{In}..... Voltage between phase and neutral conductors,

U_{Ipe}..... Voltage between phase and protective conductors,

U_{Nepe}..... Voltage between neutral and protective conductors,

f..... frequency.

Displayed results for three-phase system:

U₁₂..... Voltage between phases L1 and L2,

U₁₃..... Voltage between phases L1 and L3,

U₂₃..... Voltage between phases L2 and L3,

1.2.3 Correct connection – CW rotation sequence,

3.2.1 Invalid connection – CCW rotation sequence,

f..... frequency.

5.2 Insulation resistance

The Insulation resistance measurement is performed in order to ensure safety against electric shock through insulation. It is covered by the EN 61557-2 standard. Typical applications are:

- Insulation resistance between conductors of installation,
- Insulation resistance of non-conductive rooms (walls and floors),
- Insulation resistance of ground cables,
- Resistance of semi-conductive (antistatic) floors.

See chapter 4.1 *Function selection* for instructions on key functionality.



Figure 5.5: Insulation resistance

Test parameters for insulation resistance measurement

Uiso	Test voltage [50 V, 100 V, 250 V, 500 V, 1000 V]
Limit	Minimum insulation resistance [OFF, 0.01 MΩ ÷ 200 MΩ]

Test circuits for insulation resistance

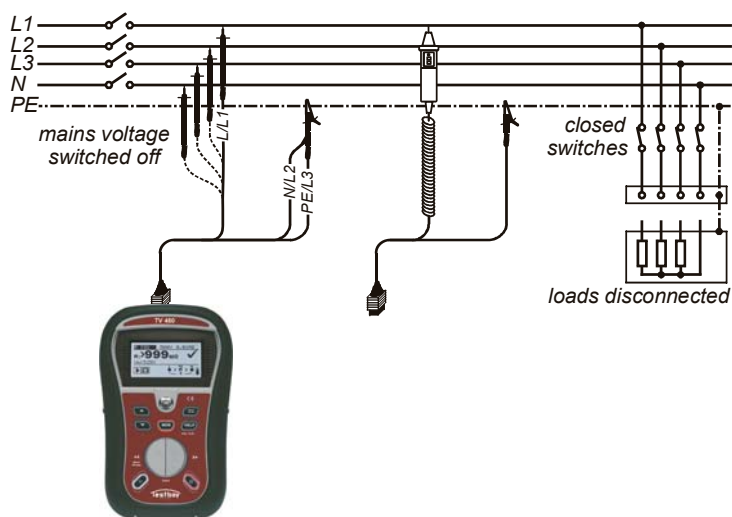

Figure 5.6: Connections for insulation measurement

Insulation resistance measuring procedure

* model TESTBOY TV 450 (TYPE B)

- ❑ Select the **INS** function using the function selector switch.
- ❑ Set the required **test voltage**.
- ❑ Enable and set **limit** value (optional).
- ❑ **Disconnect** tested installation from mains supply (and discharge insulation as required).
- ❑ **Connect** test cable to the instrument and to the item to be tested (see figure 5.6).
- ❑ Press the **TEST** key to perform the measurement (double click for continuous measurement and later press to stop the measurement).
- ❑ After the measurement is finished wait until tested item is fully discharged.
- ❑ **Store** the result by pressing the MEM key (optional)*.

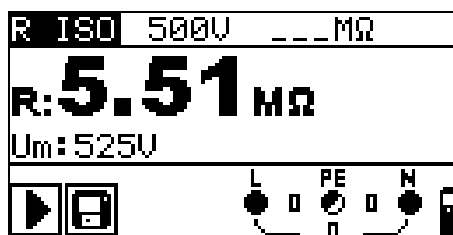

Figure 5.7: Example of insulation resistance measurement result

Displayed results:

R.....Insulation resistance

Um.....Test voltage – actual value.

5.3 Resistance of earth connection and equipotential bonding

The resistance measurement is performed in order to ensure that the protective measures against electric shock through earth connections and bondings are effective. Two sub-functions are available:

- R LOW Ω - Earth bond resistance measurement according to EN 61557-4 (200 mA),
- CONTINUITY - Continuous resistance measurement performed with 7 mA (model TESTBOY TV 450 (TYPE B)).

See chapter 4.1 *Function selection* for instructions on key functionality.

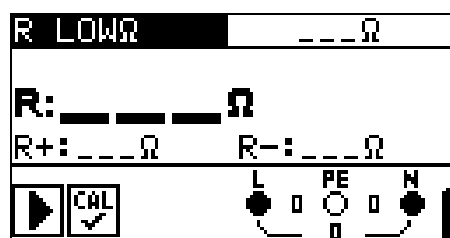

Figure 5.8: 200 mA RLOW Ω

Test parameters for resistance measurement

* model TESTBOY TV 450 (TYPE B)

TEST	Resistance measurement sub-function [R LOW Ω , CONTINUITY*]
Limit	Maximum resistance [OFF, 0.1 Ω ÷ 20.0 Ω]

5.3.1 R LOW Ω , 200 mA resistance measurement

The resistance measurement is performed with automatic polarity reversal of the test voltage.

Test circuit for R LOW Ω measurement

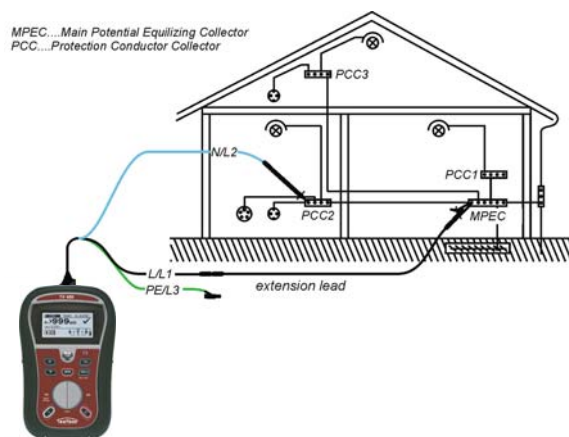

Figure 5.9: Connection of 3-wire test lead plus optional extension lead

Resistance to earth connection and equipotential bonding measurement procedure

* model TESTBOY TV 450 (TYPE B)

- Select continuity function using the function selector switch.
- Set sub-function to **R LOW Ω** .
- Enable and set **limit** (optional).
- Connect** test cable to the the instrument.
- Compensate** the test leads resistance (if necessary, see *section 5.3.3*).
- Disconnect** from mains supply and discharge installation to be tested.
- Connect** the test leads to the appropriate PE wiring (see *figure 5.9*).
- Press the **TEST** key to perform the measurement.
- After the measurement is finished **store** the result by pressing the MEM button (optional)*.

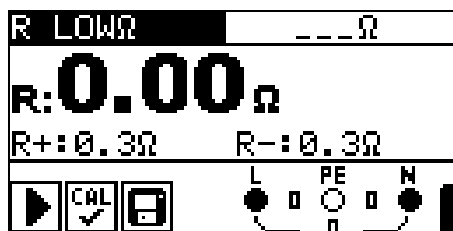

Figure 5.10: Example of RLOW result

Displayed result:

- R.....R LOW Ω resistance.
- R+.....Result at positive polarity
- R-.....Result at negative test polarity

5.3.2 Continuous resistance measurement with low current (model TESTBOY TV 450 (TYPE B))

In general, this function serves as standard Ω -meter with a low testing current. The measurement is performed continuously without polarity reversal. The function can also be applied for testing continuity of inductive components.

Test circuit for continuous resistance measurement

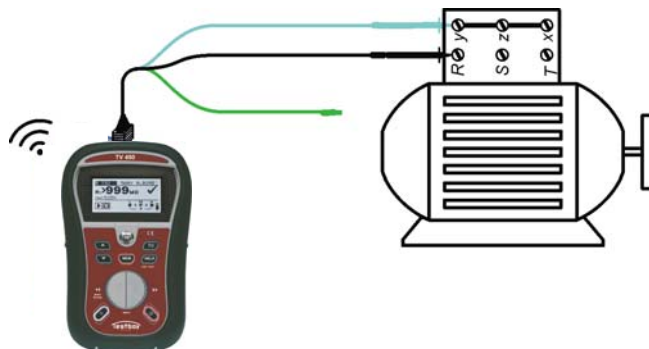

Figure 5.11: 3-wire test lead application

Continuous resistance measurement procedure

- ❑ Select continuity function using the function selector switch.
- ❑ Set sub-function **CONTINUITY**.
- ❑ Enable and set the **limit** (optional).
- ❑ **Connect** test cable to the instrument.
- ❑ **Compensate** test leads resistance (if necessary, see *section 5.3.3*).
- ❑ **Disconnect** from mains supply and discharge the object to be tested.
- ❑ **Connect** test leads to the tested object (see *figure 5.11*).
- ❑ Press the **TEST** key to begin performing a continuous measurement.
- ❑ Press the **TEST** key to stop measurement.
- ❑ After the measurement is finished, **store** the result (optional).

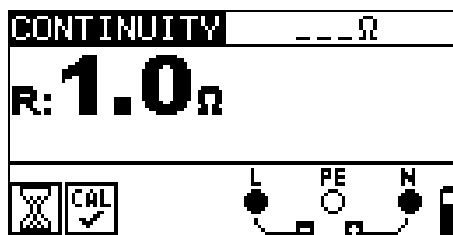

Figure 5.12: Example of continuous resistance measurement

Displayed result:

R.....Resistance

Note:

- ❑ Continuous buzzer sound indicates that measured resistance is less than 2 Ω .

5.3.3 Compensation of test leads resistance

This chapter describes how to compensate the test leads resistance in both continuity functions, R LOW Ω and CONTINUITY (model TESTBOY TV 450 (TYPE B)). Compensation is required to eliminate the influence of test leads resistance and the internal resistances of the instrument on the measured resistance. The lead compensation is therefore a very important feature to obtain correct result.

Each of R LOW Ω and CONTINUITY (model TESTBOY TV 450 (TYPE B)) has own compensation.  symbol is displayed if the compensation was carried out successfully.

Circuits for compensating the resistance of test leads

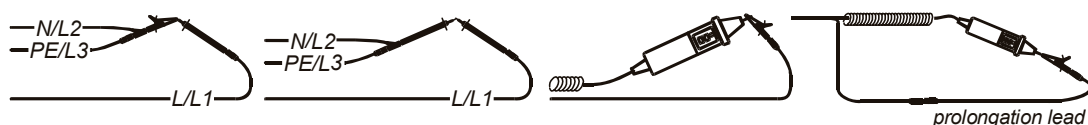

Figure 5.13: Shorted test leads

Compensation of test leads resistance procedure

- Select R LOW Ω or CONTINUITY (model TESTBOY TV 450 (TYPE B)) function.
- **Connect** test cable to the instrument and short the test leads together (see figure 5.13).
- Press **TEST** to perform resistance measurement.
- Press the **CAL** key to compensate leads resistance.

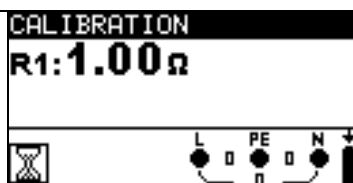

Figure 5.14: Results with old calibration values

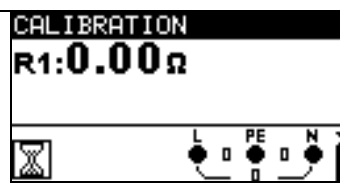



Figure 5.15: Results with new calibration values

Note:

- The highest value for lead compensation is 5 Ω . If the resistance is higher the compensation value is set back to default value.

 is displayed if no calibration value is stored.

5.4 Testing RCDs

Various test and measurements are required for verification of RCD(s) in RCD protected installations. Measurements are based on the EN 61557-6 standard.

The following measurements and tests (sub-functions) can be performed:

- Contact voltage,
- Trip-out time,
- Trip-out current,
- RCD autotest.

See chapter 4.1 *Function selection* for instructions on key functionality.

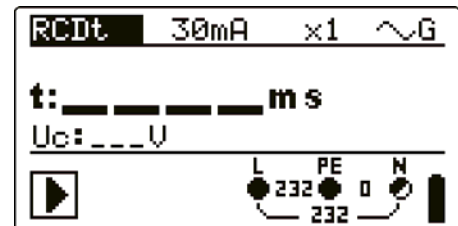

Figure 5.16: RCD test

Test parameters for RCD test and measurement

TEST	RCD sub-function test [RCDt, RCD I, AUTO, Uc].
$I_{\Delta N}$	Rated RCD residual current sensitivity $I_{\Delta N}$ [10 mA, 30 mA, 100 mA, 300 mA, 500 mA, 1000 mA].
type	RCD type [G, S], test current waveform plus starting polarity [~ , ~ , ~ , ~ , ~ , ~* , ~*].
MUL	Multiplication factor for test current [$\frac{1}{2}$, 1, 2, 5 $I_{\Delta N}$].
Ulim	Conventional touch voltage limit [25 V, 50 V].

* Model TESTBOY TV 450 (TYPE B)

Notes:

- Ulim can be selected in the Uc sub-function only.

The instrument is intended for testing of **G**eneral (non-delayed) and **S**elective (time-delayed) RCDs, which are suited for:

- Alternating residual current (AC type, marked with ~ symbol),
- Pulsating residual current (A type, marked with ~ symbol).
- Pulsating residual current (A type, marked with ~ symbol).
- Model TESTBOY TV 450 (Type B): DC residual current (B type, marked with == symbol).

Time delayed RCDs have delayed response characteristics. As the contact voltage pre-test or other RCD tests influence the time delayed RCD it takes a certain period to recover into normal state. Therefore a time delay of 30 s is inserted before performing trip-out test by default.

Connections for testing RCD

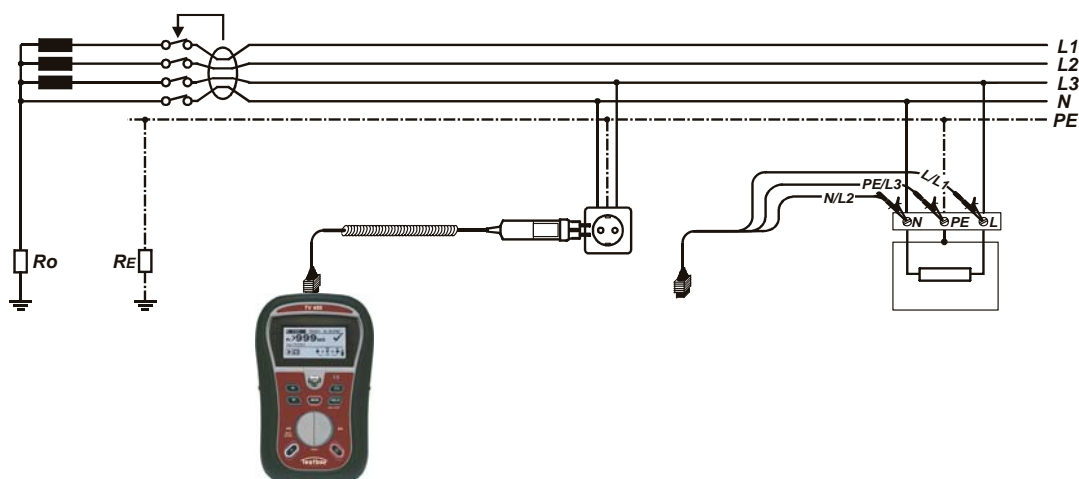

Figure 5.17: Connecting the plug commander and the 3-wire test lead

5.4.1 Contact voltage (RCD U_c)

A current flowing into the PE terminal causes a voltage drop on earth resistance, i.e. voltage difference between PE equipotential bonding circuit and earth. This voltage difference is called contact voltage and is present on all accessible conductive parts connected to the PE. It shall always be lower than the conventional safety limit voltage. The contact voltage is measured with a test current lower than $\frac{1}{2} I_{\Delta N}$ to avoid trip-out of the RCD and then normalized to the rated $I_{\Delta N}$.

Contact voltage measurement procedure

* model TESTBOY TV 450 (TYPE B)

- ❑ Select the **RCD** function using the function selector switch.
- ❑ Set sub-function **U_c**.
- ❑ Set test **parameters** (if necessary).
- ❑ **Connect** test cable to the instrument.
- ❑ **Connect** test leads to the item to be tested (see figure 5.17).
- ❑ Press the **TEST** key to perform the measurement.
- ❑ **Store** the result by pressing the MEM key (optional)*.

The contact voltage result relates to the rated nominal residual current of the RCD and is multiplied by an appropriate factor (depending on RCD type and type of test current). The 1.05 factor is applied to avoid negative tolerance of result. See table 5.1 for detailed contact voltage calculation factors.

RCD type		Contact voltage U_c proportional to	Rated $I_{\Delta N}$	
AC	G	$1.05 \times I_{\Delta N}$	any	Both models
AC	S	$2 \times 1.05 \times I_{\Delta N}$		
A	G	$1.4 \times 1.05 \times I_{\Delta N}$	≥ 30 mA	
A	S	$2 \times 1.4 \times 1.05 \times I_{\Delta N}$	< 30 mA	
A	G	$2 \times 1.05 \times I_{\Delta N}$		
A	S	$2 \times 2 \times 1.05 \times I_{\Delta N}$		
B	G	$2 \times 1.05 \times I_{\Delta N}$	any	Model TESTBOY TV 450 (Type B) only
B	S	$2 \times 2 \times 1.05 \times I_{\Delta N}$		

Table 5.1: Relationship between U_c and $I_{\Delta N}$

Loop resistance is indicative and calculated from U_c result (without additional proportional factors) according to: $R_L = \frac{U_c}{I_{\Delta N}}$.

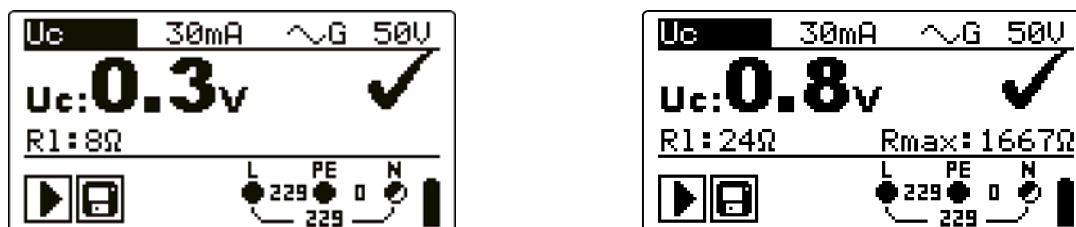

UK version

Figure 5.18: Example of contact voltage measurement results

Displayed results:
 U_cContact voltage.
 R_lFault loop resistance.

5.4.2 Trip-out time (RCDt)

Trip-out time measurement verifies the sensitivity of the RCD at different residual currents.

Trip-out time measurement procedure

* model TESTBOY TV 450 (TYPE B)

- Select the **RCD** function using the function selector switch.
- Set sub-function **RCDt**.
- Set test **parameters** (if necessary).
- Connect** test cable to the instrument.
- Connect** test leads to the item to be tested (see *figure 5.17*).
- Press the **TEST** key to perform the measurement.
- Store** the result by pressing the MEM key (optional)*.

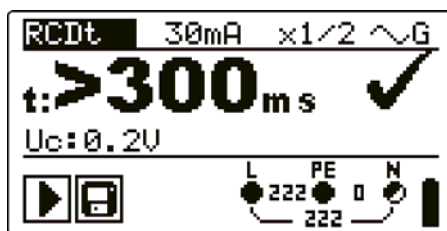

Figure 5.19: Example of trip-out time measurement results

Displayed results:

t.....Trip-out time,

Uc.....Contact voltage for rated $I_{\Delta N}$.

5.4.3 Trip-out current (RCD I)

A continuously rising residual current is intended for testing the threshold sensitivity for RCD trip-out. The instrument increases the test current in small steps through appropriate range as follows:

RCD type	Slope range		Waveform	Note
	Start value	End value		
AC	$0.2 \times I_{\Delta N}$	$1.1 \times I_{\Delta N}$	Sine	Both models
A ($I_{\Delta N} \geq 30 \text{ mA}$)	$0.2 \times I_{\Delta N}$	$1.5 \times I_{\Delta N}$	Pulsed	
A ($I_{\Delta N} = 10 \text{ mA}$)	$0.2 \times I_{\Delta N}$	$2.2 \times I_{\Delta N}$	DC	Model TESTBOY TV 450 (TYPE B) only
B	$0.2 \times I_{\Delta N}$	$2.2 \times I_{\Delta N}$		

Maximum test current is I_{Δ} (trip-out current) or end value in case the RCD didn't trip-out.

Trip-out current measurement procedure

* model TESTBOY TV 450 (TYPE B)

- Select the **RCD** function using the function selector switch.
- Set sub-function **RCD I**.
- Set test **parameters** (if necessary).
- Connect** test cable to the instrument.
- Connect** test leads to the item to be tested (see figure 5.17).
- Press the **TEST** key to perform the measurement.
- Store** the result by pressing the MEM key (optional)*.

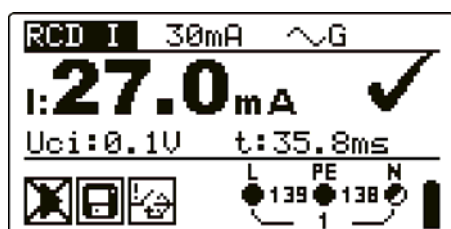

Trip-out



After the RCD is turned on again

Figure 5.20: Trip-out current measurement result example

Displayed results:

I Trip-out current,

Uci Contact voltage at trip-out current I or end value in case the RCD didn't trip,

t Trip-out time.

5.4.4 RCD Autotest

RCD autotest function is intended to perform a complete RCD test (trip-out time at different residual currents, trip-out current and contact voltage) in one set of automatic tests, guided by the instrument.

Additional key:

HELP / DISPLAY	Toggles between top and bottom part of results field.
-----------------------	---

RCD autotest procedure

* model TESTBOY TV 450 (TYPE B)

RCD Autotest steps	Notes
<input type="checkbox"/> Select the RCD function using the function selector switch. <input type="checkbox"/> Set sub-function AUTO . <input type="checkbox"/> Set test parameters (if necessary). <input type="checkbox"/> Connect test cable to the instrument. <input type="checkbox"/> Connect test leads to the to the item to be tested (see <i>figure 5.17</i>). <input type="checkbox"/> Press the TEST key to perform the test.	Start of test
<input type="checkbox"/> Test with $I_{\Delta N}$, 0° (step 1).	RCD should trip-out
<input type="checkbox"/> Re-activate RCD. <input type="checkbox"/> Test with $I_{\Delta N}$, 180° (step 2).	RCD should trip-out
<input type="checkbox"/> Re-activate RCD. <input type="checkbox"/> Test with $5 \times I_{\Delta N}$, 0° (step 3).	RCD should trip-out
<input type="checkbox"/> Re-activate RCD. <input type="checkbox"/> Test with $5 \times I_{\Delta N}$, 180° (step 4).	RCD should trip-out
<input type="checkbox"/> Re-activate RCD. <input type="checkbox"/> Test with $\frac{1}{2} \times I_{\Delta N}$, 0° (step 5). <input type="checkbox"/> Test with $\frac{1}{2} \times I_{\Delta N}$, 180° (step 6).	RCD should not trip-out RCD should not trip-out
<input type="checkbox"/> Trip-out current test, 0° (step 7).	RCD should trip-out
<input type="checkbox"/> Re-activate RCD. <input type="checkbox"/> Trip-out current test, 180° (step 8).	RCD should trip-out
<input type="checkbox"/> Re-activate RCD. <input type="checkbox"/> Store the result by pressing the MEM key (optional)*.	End of test

Result examples:

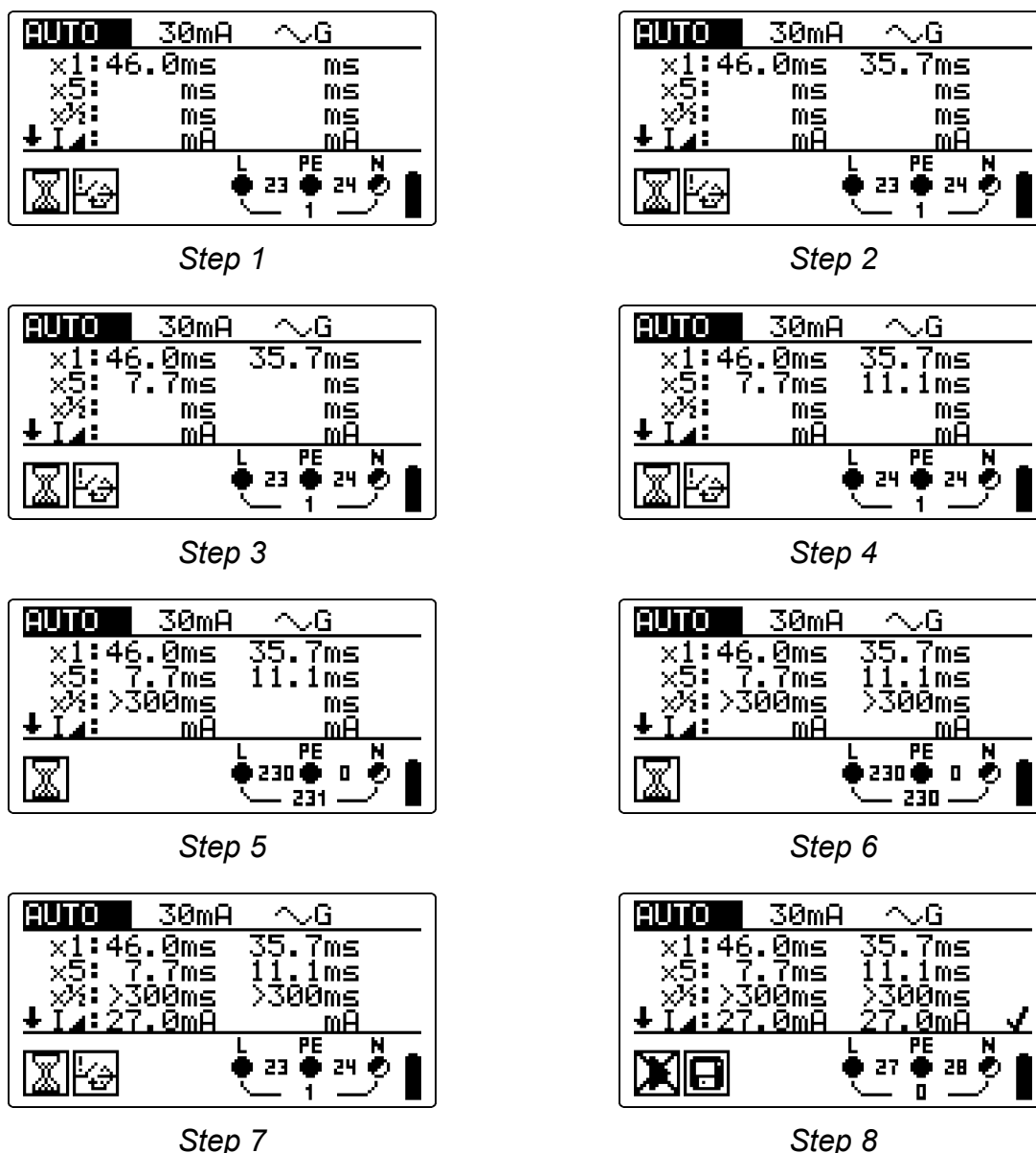

Figure 5.21: Individual steps in RCD autotest

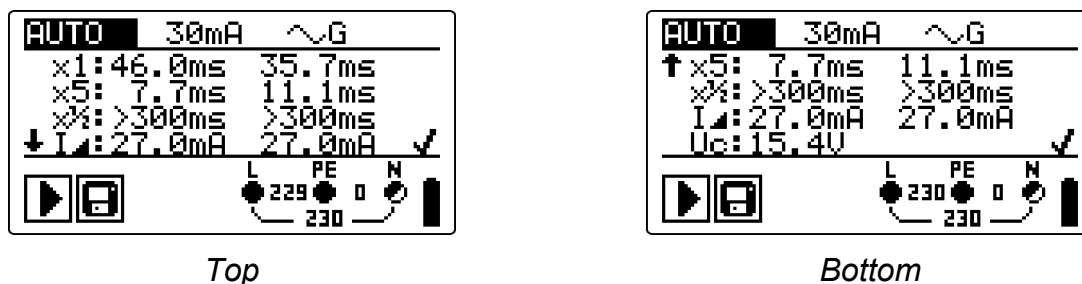







Figure 5.22: Two parts of result field in RCD autotest

Displayed results:

x1 Step 1 trip-out time (, $I_{\Delta N}$, 0°),
 x1 Step 2 trip-out time (, $I_{\Delta N}$, 180°),
 x5 Step 3 trip-out time (, $5 \times I_{\Delta N}$, 0°),
 x5 Step 4 trip-out time (, $5 \times I_{\Delta N}$, 180°),
 x $\frac{1}{2}$ Step 5 trip-out time (, $\frac{1}{2} \times I_{\Delta N}$, 0°),
 x $\frac{1}{2}$ Step 6 trip-out time (, $\frac{1}{2} \times I_{\Delta N}$, 180°),
 I \blacktriangle Step 7 trip-out current (0°),
 I \blacktriangle Step 8 trip-out current (180°),
 Uc Contact voltage for rated $I_{\Delta N}$.

Notes:

- The autotest sequence is immediately stopped if any incorrect condition is detected, e.g. excessive Uc or trip-out time out of bounds.
- Auto test is finished without x5 tests in case of testing the RCD type A with rated residual currents of $I_{\Delta n} = 300 \text{ mA}$, 500 mA , and 1000 mA . In this case auto test result passes if all other results pass, and indications for x5 are omitted.
- Tests for sensitivity (I_{Δ} , steps 7 and 8) are omitted for selective type RCD.

5.5 Fault loop impedance and prospective fault current

Fault loop is a loop comprised by mains source, line wiring and PE return path to the mains source. The instrument measures the impedance of the loop and calculates the short circuit current. The measurement is covered by requirements of the EN 61557-3 standard.

See chapter 4.1 *Function selection* for instructions on key functionality.

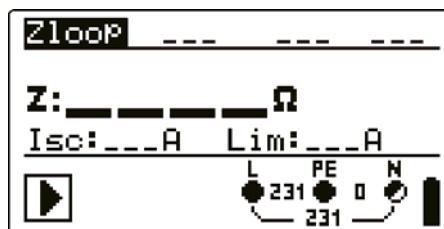

Figure 5.23: Fault loop impedance

Test parameters for fault loop impedance measurement

Test	Selection of fault loop impedance sub-function [Zloop, Zs rcd]
Fuse type	Selection of fuse type [---, NV, gG, B, C, K, D]
Fuse I	Rated current of selected fuse
Fuse T	Maximum breaking time of selected fuse
Lim	Minimum short circuit current for selected fuse.

See Appendix A for reference fuse data.

Circuits for measurement of fault loop impedance

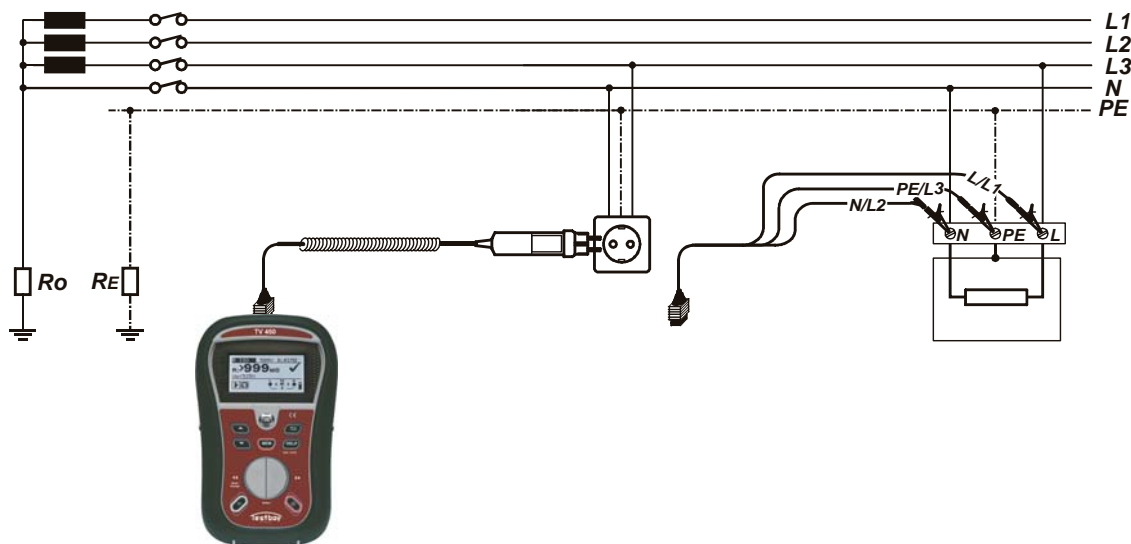

Figure 5.24: Connection of plug cable and 3-wire test lead

Fault loop impedance measurement procedure

* model TESTBOY TV 450 (TYPE B)

- ❑ Select the **Zloop** or **Zs rcd** subfunction using the function selector switch and ▲/▼ keys
- ❑ Select test **parameters** (optional).
- ❑ **Connect** test cable the TESTBOY TV 450.
- ❑ **Connect** test leads to the the item to be tested (see *figure 5.24 and 5.17*).
- ❑ Press the **TEST** key to perform the measurement.
- ❑ **Store** the result by pressing the MEM key (optional)*.

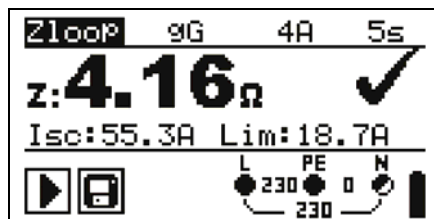

Figure 5.25: Examples of loop impedance measurement result

Displayed results:

Z..... Fault loop impedance,

Isc..... Prospective fault current,

Lim Low limit prospective short-circuit current value or high limit fault loop impedance value for the UK version.

Prospective fault current I_{SC} is calculated from measured impedance as follows:

$$I_{SC} = \frac{U_n \times k_{SC}}{Z}$$

where:

U_n Nominal U_{L-PE} voltage (see table below),

k_{SC} Correction factor for I_{SC} (see chapter 4.2.6).

U_n	Input voltage (L-PE)
115 V	$(100 \text{ V} \leq U_{L-PE} < 160 \text{ V})$
230 V	$(160 \text{ V} \leq U_{L-PE} \leq 264 \text{ V})$

Notes:

- ❑ High fluctuations of mains voltage can influence the measurement results (the noise sign  is displayed in the message field). In this case it is recommended to repeat few measurements to check if the readings are stable.
- ❑ This measurement will trip-out the RCD in RCD-protected electrical installation if test Zloop is selected.
- ❑ Select Zs rcd to prevent trip-out of RCD in RCD protected installation.

5.6 Line impedance and prospective short-circuit current

Line impedance is measured in loop comprising of mains voltage source and line wiring. It is covered by requirements of the EN 61557-3 standard.

See chapter 4.1 *Function selection* for instructions on key functionality.

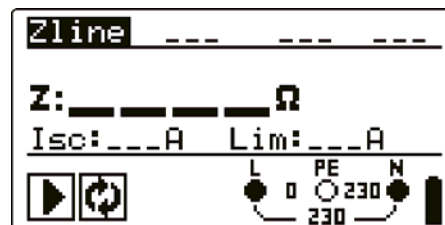

Figure 5.26: Line impedance

Test parameters for line impedance measurement

FUSE type	Selection of fuse type [---, NV, gG, B, C, K, D]
FUSE I	Rated current of selected fuse
FUSE T	Maximum breaking time of selected fuse
Lim	Minimum short circuit current for selected fuse.

See Appendix A for reference fuse data.

Connections for measurement of line impedance

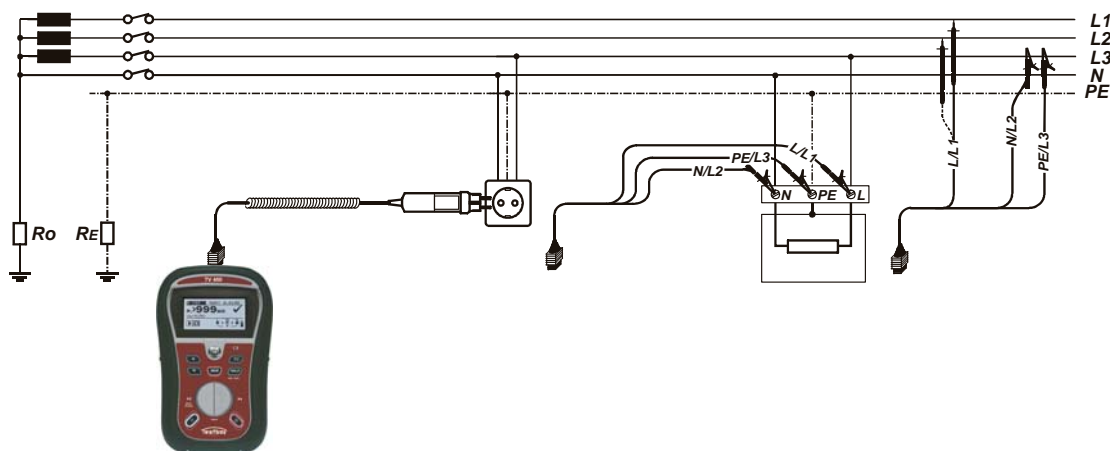
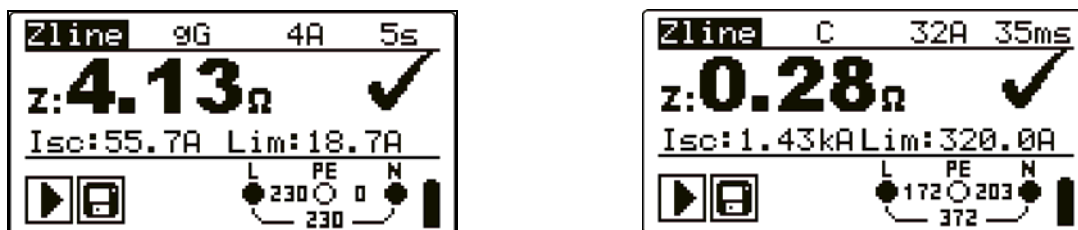

Figure 5.27: Phase-neutral or phase-phase line impedance measurement – connection of plug commander and 3-wire test lead

Line impedance measurement procedure

* model TESTBOY TV 450 (TYPE B)

- ❑ Select the **Z-LINE** function using the function selector switch.
- ❑ Select test **parameters** (optional).
- ❑ **Connect** test cable to the instrument.
- ❑ **Connect** test leads to the to the item to be tested (see *figure 5.27*).
- ❑ Press the **TEST** key to perform the measurement.
- ❑ **Store** the result by pressing the MEM key (optional)*.



Line to neutral

Line to line

Figure 5.28: Examples of line impedance measurement result

Displayed results:

Z.....Line impedance,

I_{sc}.....Prospective short-circuit current,

Lim.....Low limit prospective short-circuit current value or high limit line impedance value for the UK version.

Prospective short circuit current is calculated as follows:

$$I_{sc} = \frac{U_n \times k_{sc}}{Z}$$

where:

U_n.....Nominal L-N or L1-L2 voltage (see table below),

k_{sc}.....Correction factor for I_{sc} (see chapter 4.2.6).

U _n	Input voltage range (L-N or L1-L2)
115 V	(100 V ≤ U _{L-N} < 160 V)
230 V	(160 V ≤ U _{L-N} ≤ 264 V)
400 V	(264 V < U _{L-N} ≤ 440 V)

Note:

- High fluctuations of mains voltage can influence the measurement results (the noise sign  is displayed in the message field). In this case it is recommended to repeat few measurements to check if the readings are stable.

5.7 Earth resistance (model TESTBOY TV 450 (TYPE B))

Earth resistance is one of the most important parameters for protection against electric shock. Main earthing arrangements, lightning systems, local earthings, etc can be verified with the earthing resistance test. The measurement conforms to the EN 61557-5 standard.

See chapter 4.1 *Function selection* for instructions on key functionality.



Figure 5.29: Earth resistance

Test parameters for earth resistance measurement

Limit	Maximum resistance OFF, $1 \Omega \div 5 \text{ k}\Omega$
-------	---

Connections for earth resistance measurement

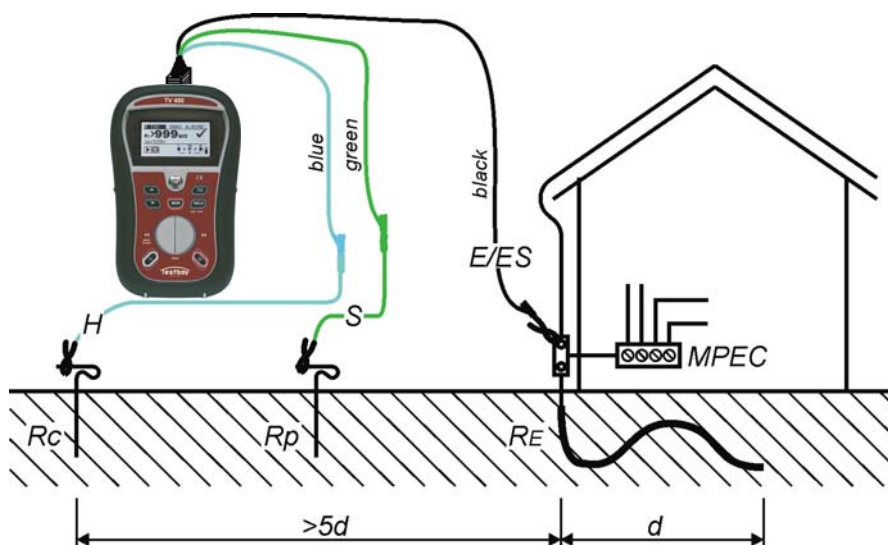

Figure 5.30: Resistance to earth, measurement of main installation earthing

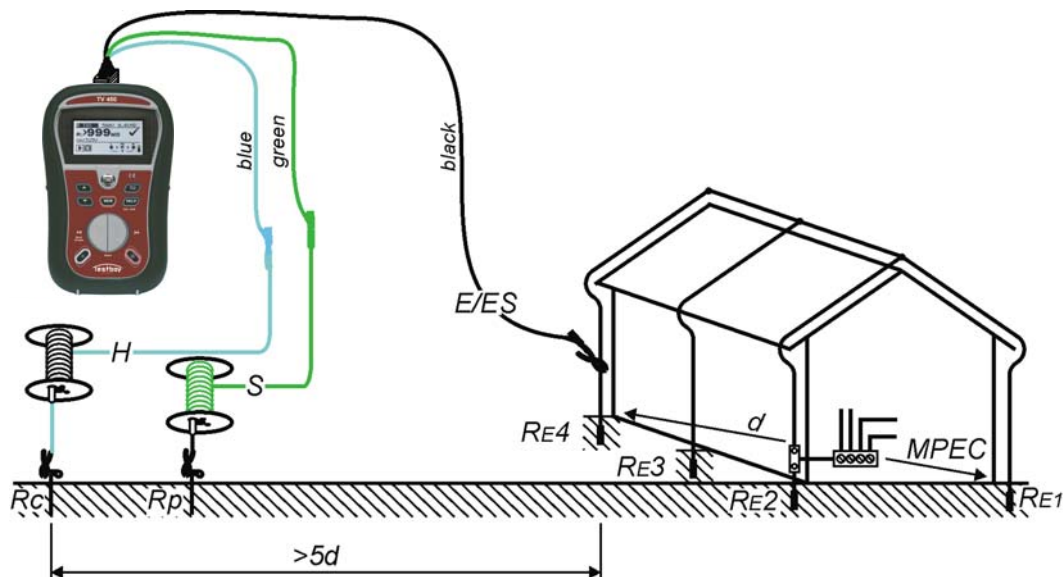

Figure 5.31: Resistance to earth, measurement of a lightning protection system

Earth resistance measurements, common measurement procedure

- ❑ Select **EARTH** function using the function selector switch.
- ❑ Enable and set **limit** value(optional).
- ❑ **Connect** test leads to the instrument
- ❑ **Connect** the item to be tested (see figures 5.30, 5.31).
- ❑ Press the **TEST** key to perform the measurement..
- ❑ **Store** the result by pressing the MEM key (optional).



Figure 5.32: Example of earth resistance measurement result

Displayed results for earth resistance measurement:

R..... Earth resistance,
 Rp..... Resistance of S (potential) probe,
 Rc..... Resistance of H (current) probe.

Notes:

- ❑ High resistance of S and H probes could influence the measurement results. In this case, “Rp” and “Rc” warnings are displayed. There is no pass / fail indication in this case.
- ❑ High noise currents and voltages in earth could influence the measurement results. The tester displays the “noise” warning in this case.
- ❑ Probes must be placed at sufficient distance from the measured object.

5.8 PE test terminal

It can happen that a dangerous voltage is applied to the PE wire or other accessible metal parts. This is a very dangerous situation since the PE wire and MPEs are considered to be earthed. An often reason for this fault is incorrect wiring (see examples below).

When touching the **TEST** key in all functions that require mains supply the user automatically performs this test.

Examples for application of PE test terminal

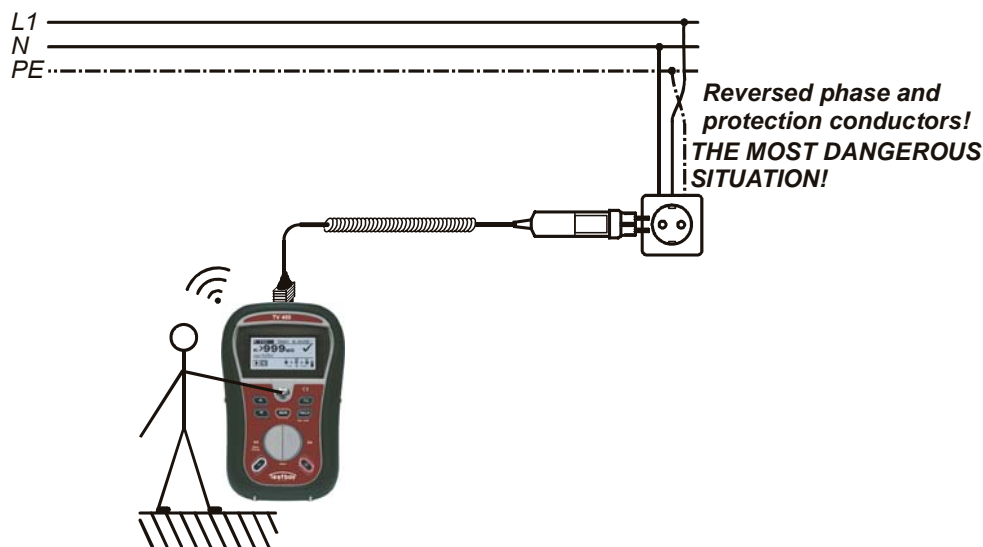

Figure 5.33: Reversed L and PE conductors (application of plug commander)

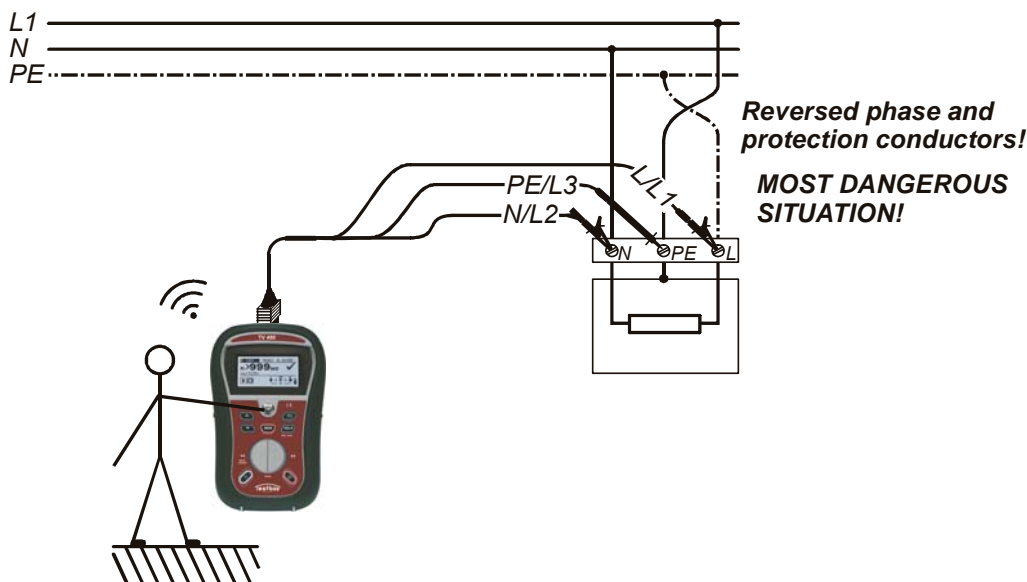

Figure 5.34: Reversed L and PE conductors (application of 3-wire test lead)

PE terminal test procedure

- ❑ **Connect** test cable to the instrument.
- ❑ **Connect** test leads to the to the item to be tested (see *figures 5.33 and 5.34*).
- ❑ Touch PE test probe (the **TEST** key) for at least one second.
- ❑ If PE terminal is connected to phase voltage the warning message is displayed, instrument buzzer is activated, and further measurements are disabled in Z-LOOP and RCD functions.

Warning:

- ❑ If dangerous voltage is detected on the tested PE terminal, immediately stop all measurements, find and remove the fault!

Notes:

- ❑ In the SETTINGS and VOLTAGE TRMS menus the PE terminal is not tested.
- ❑ PE test terminal does not operate in case the operator's body is completely insulated from floor or walls!

6 Data handling (model TESTBOY TV 450 (TYPE B))

6.1 Memory organization

Measurement results together with all relevant parameters can be stored in the instrument's memory. After the measurement is completed, results can be stored to the flash memory of the instrument, together with the sub-results and function parameters.

6.2 Data structure

The instrument's memory place is divided into 3 levels each containing 199 locations. The number of measurements that can be stored into one location is not limited.

The **data structure field** describes the location of the measurement (which object, block, fuse) and where can be accessed.

In the **measurement field** there is information about type and number of measurements that belong to the selected structure element (object and block and fuse).

The main advantages of this system are:

- Test results can be organized and grouped in a structured manner that reflects the structure of typical electrical installations.
- Customized names of data structure elements can be uploaded from TESTBOY TV 450 PC SW.
- Simple browsing through structure and results.
- Test reports can be created with no or little modifications after downloading results to a PC.

```
RECALL RESULTS
^ [OBJ]OBJECT 002
 [BLK]BLOCK 001
> [FUS]FUSE 001
-----
> No.: 2/5
  Zline
```

Figure 6.1: Data structure and measurement fields

Data structure field

RECALL RESULTS	Memory operation menu
OBJECT: 001 BLOCK: 001 FUSE: 001	Data structure field
OBJECT: 001	<input type="checkbox"/> 1st level: OBJECT: Default location name (object and its successive number).
BLOCK: 001	<input type="checkbox"/> 2nd level: BLOCK: Default location name (block and its successive number).
FUSE: 001	<input type="checkbox"/> 3rd level: FUSE: Default location name (fuse and its successive number). <input type="checkbox"/> 001: No. of selected element.
No.: 20 [112]	No. of measurements in selected location [No. of measurements in selected location and its sublocations]
Measurement field	
Zline	Type of stored measurement in the selected location.
No.: 2/5	No. of selected test result / No. of all stored test results in selected location.

6.3 Storing test results

After the completion of a test the results and parameters are ready for storing (📁 icon is displayed in the information field). By pressing the **MEM** key, the user can store the results.

```

Save results
[OBJ]OBJECT 002
[BLO]BLOCK 001
> [FUS]FUSE 001
MEM : SAVE          FREE:
                      91.9%

```

Figure 6.2: Save test menu

Memory free: 99.6% Memory available for storing results.

Keys in save test menu - data structure field:

TAB	Selects the location element (Object / Block / Fuse)
UP / DOWN	Selects number of selected location element (1 to 199)
MEM	Saves test results to the selected location and returns to the measuring menu.
Function selectors / TEST	Exits back to main function menu.

Notes:

- ❑ The instrument offers to store the result to the last selected location by default.
- ❑ If the measurement is to be stored to the same location as the previous one just press the **MEM** key twice

6.4 Recalling test results

Press the **MEM** key in a main function menu when there is no result available for storing or select **MEMORY** in the **SETTINGS** menu.

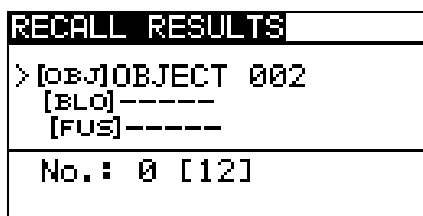

Figure 6.3: Recall menu - installation structure field selected

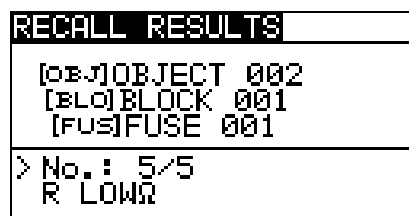

Figure 6.4: Recall menu - measurements field selected

Keys in recall memory menu (installation structure field selected):

TAB	Selects the location element (Object / Block / Fuse). Enters measurements field.
UP / DOWN	Selects the location element in selected level.
Function selectors / TEST	Exits back to main function menu.
MEM	Enters measurements field.

Keys in recall memory menu (measurements field):

UP / DOWN	Selects the stored measurement.
TAB	Returns to installation structure field.
Function selector / TEST	Exits back to main function menu.
MEM	View selected measurement results.

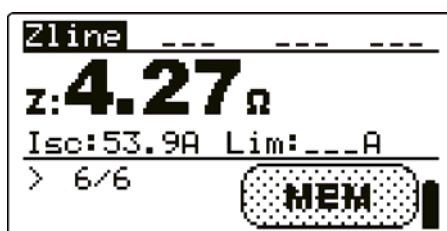

Figure 6.5: Example of recalled measurement result

Keys in recall memory menu (measurement results are displayed)

UP / DOWN	Displays measurement results stored in selected location
MEM	Returns to measurements field.
Function selector / TEST	Exits back to main function menu.

6.5 Clearing stored data

6.5.1 Clearing complete memory content

Select **CLEAR ALL MEMORY** in **MEMORY** menu. A warning will be displayed.

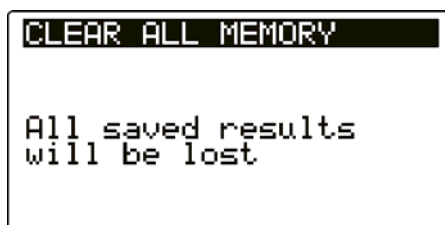

Figure 6.6: Clear all memory

Keys in clear all memory menu

TEST	Confirms clearing of complete memory content.
Function selectors	Exits back to main function menu without changes.

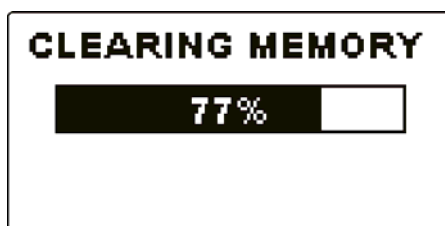

Figure 6.7: Clearing memory in progress

6.5.2 Clearing measurement(s) in selected location

Select **DELETE RESULTS** in **MEMORY** menu.



Figure 6.8: Clear measurements menu (data structure field selected)

Keys in delete results menu (installation structure field selected):

TAB	Selects the location element (Object / D. Board / Circuit or Bonding or Electrode).
UP / DOWN	Selects the location element in selected level.
Function selector / TEST	Exits back to main function menu.
HELP	Enters dialog box for deleting all measurements in selected location and its sublocations.

MEM	Enters measurements field for deleting individual measurements.
------------	---

Keys in dialog for confirmation to clear results in selected location:

TEST	Deletes all results in selected location.
MEM	Exits back to delete results menu without changes.
Function selectors	Exits back to main function menu without changes.

6.5.3 Clearing individual measurements

Select **DELETE RESULTS** in **MEMORY** menu.

DELETE RESULTS
[OB.]OBJECT 002 [BL.]BLOCK 001 [FUS]FUSE 001
> No. : 5/5 R LOWΩ

Figure 6.9: Menu for clearing individual measurement (installation structure field selected)

Keys in delete results menu (installation structure field selected):

TAB	Selects the location element (Object / D. Board / Circuit or Bonding or Electrode).
UP / DOWN	Selects the location element in selected level.
Function selector / TEST	Exits back to main function menu.
MEM	Enters measurements field.

Keys in delete results menu (measurements field selected):

TAB	Returns to installation structure field.
UP / DOWN	Selects measurement.
TEST	Opens dialog box for confirmation to clear selected measurement.
HELP	Enters dialog box for deleting selected measurement.
Function selector	Exits back to main function menu without changes.

Keys in dialog for confirmation to clear selected result(s):

TEST	Deletes selected measurement result.
MEM	Exits back to measurements field without changes.
Function selector	Exits back to main function menu without changes.

```

DELETE RESULTS
[OB]OBJECT 002
[BLO]BLOCK 001
[FUS]FUSE 001
-----
> No. : 5/5
CLEAR RESULT?

```

Figure 6.10: Dialog for confirmation

```

DELETE RESULTS
[OB]OBJECT 002
[BLO]BLOCK 001
[FUS]FUSE 001
-----
> No. : 4/4
VOLTAGE TRMS

```

Figure 6.11: Display after measurement was cleared

6.5.4 Renaming installation structure elements

Default installation structure elements are 'Object', 'D.Board', 'Circuit', 'Electrode' and 'Circuit'. In the PC SW package TESTBOY TV 450 default names can be changed with customized names that corresponds the installation under test. Refer to PC SW TESTBOY TV 450 HELP menu for information how to upload customized installation names to the instrument.

```

RECALL RESULTS
-----
[OB]APARTMENT1
[BLO]MAIN-BOARD
> [FUS]KITCHEN
-----
No. : 72

```

Figure 6.12: Example of menu with customized installation structure names

6.6 Communication

Stored results can be transferred to a PC. A special communication program on the PC automatically identifies the instrument and enables data transfer between the instrument and the PC.

There are two communication interfaces available on the instrument: USB or RS 232. The instrument automatically selects the communication mode according to detected interface. USB interface has priority.

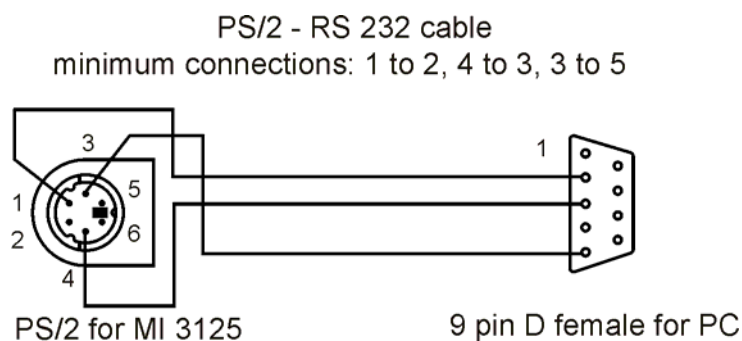

Figure 6.13: Interface connection for data transfer over PC COM port

How to transfer stored data:

- ❑ RS 232 communication: connect a PC COM port to the instrument PS/2 connector using the PS/2 - RS232 serial communication cable;
- ❑ USB communication selected: connect a PC USB port to the instrument USB connector using the USB interface cable.
- ❑ Switch **on** the PC and the instrument.
- ❑ **Run** the *TESTBOY TV 450* program.
- ❑ The PC and the instrument will automatically recognize each other.
- ❑ The instrument is prepared to download data to the PC.

The program *TESTBOY TV 450* is a PC software running on Windows 95/98, Windows NT, Windows 2000, Windows XP, Windows Vista. Read the file README_TESTBOY TV 450.txt on CD for instructions about installing and running the program.

Note:

- ❑ USB drivers should be installed on PC before using the USB interface. Refer to USB installation instructions available on installation CD.

7 Upgrading the instrument

The instrument can be upgraded from a PC via the RS232 communication port. This enables to keep the instrument up to date even if the standards or regulations change. The upgrade can be carried with help of a special upgrading software and the communication cable as shown on *Figure 6.13*. Please contact your dealer for more information.

8 Maintenance

Unauthorized persons are not allowed to open the TESTBOY TV 450 instrument. There are no user replaceable components inside the instrument, except the battery and fuse under rear cover.

8.1 Fuse replacement

There is a fuse under back cover of the TESTBOY TV 450 instrument.

- F1
M 0.315 A / 250 V, 20×5 mm
This fuse protects internal circuitry for continuity functions if test probes are connected to the mains supply voltage by mistake during measurement.

Warnings:

-  **Disconnect all measuring accessory and switch off the instrument before opening battery / fuse compartment cover, hazardous voltage inside!**
- Replace blown fuse with original type only, otherwise the instrument may be damaged and/or operator's safety impaired!

Position of fuse can be seen in *Figure 3.4* in chapter *3.3 Back panel*.

8.2 Cleaning

No special maintenance is required for the housing. To clean the surface of the instrument use a soft cloth slightly moistened with soapy water or alcohol. Then leave the instrument to dry totally before use.

Warnings:

- Do not use liquids based on petrol or hydrocarbons!
- Do not spill cleaning liquid over the instrument!

8.3 Periodic calibration

It is essential that the test instrument is regularly calibrated in order that the technical specification listed in this manual is guaranteed. We recommend an annual calibration. Only an authorized technical person can do the calibration. Please contact your dealer for further information.

8.4 Service

For repairs under warranty, or at any other time, please contact your distributor.

9 Technical specifications

9.1 Insulation resistance

Insulation resistance (nominal voltages 50 V_{DC}, 100 V_{DC} and 250 V_{DC})

Measuring range according to EN61557 is 0.15 MΩ ÷ 199.9 MΩ.

Measuring range (MΩ)	Resolution (MΩ)	Accuracy
0.00 ÷ 19.99	0.01	±(5 % of reading + 3 digits)
20.0 ÷ 99.9	0.1	±(10 % of reading)
100.0 ÷ 199.9		±(20 % of reading)

Insulation resistance (nominal voltages 500 V_{DC} and 1000 V_{DC})

Measuring range according to EN61557 is 0.15 MΩ ÷ 1 GΩ.

Measuring range (MΩ)	Resolution (MΩ)	Accuracy
0.00 ÷ 19.99	0.01	±(5 % of reading + 3 digits)
20.0 ÷ 199.9	0.1	±(5 % of reading)
200 ÷ 999	1	±(10 % of reading)

Voltage

Measuring range (V)	Resolution (V)	Accuracy
0 ÷ 1200	1	±(3 % of reading + 3 digits)

Nominal voltages50 V_{DC}, 100 V_{DC}, 250 V_{DC}, 500 V_{DC}, 1000 V_{DC}

Open circuit voltage-0 % / +20 % of nominal voltage

Measuring current.....min. 1 mA at R_N=U_N×1 kΩ/V

Short circuit current..... max. 3 mA

The number of possible tests..... > 1200, with a fully charged battery

Auto discharge after test.

Specified accuracy is valid if 3-wire test lead is used while it is valid up to 100 MΩ if tip commander is used.

Specified accuracy is valid up to 100 MΩ if relative humidity > 85 %.

In case the instrument gets moistened, the results could be impaired. In such case, it is recommended to dry the instrument and accessories for at least 24 hours.

The error in operating conditions could be at most the error for reference conditions (specified in the manual for each function) ±5 % of measured value.

9.2 Continuity

9.2.1 Resistance R LOW Ω

Measuring range according to EN61557 is 0.16 Ω ÷ 1999 Ω .

Measuring range R (Ω)	Resolution (Ω)	Accuracy
0.00 ÷ 19.99	0.01	$\pm(3\%$ of reading + 3 digits)
20.0 ÷ 199.9	0.1	$\pm(5\%$ of reading)
200 ÷ 1999	1	

Open-circuit voltage6.5 VDC ÷ 9 VDC
 Measuring currentmin. 200 mA into load resistance of 2 Ω
 Test lead compensationup to 5 Ω
 The number of possible tests> 2000, with a fully charged battery
 Automatic polarity reversal of the test voltage.

9.2.2 Resistance CONTINUITY (model TESTBOY TV 450 (TYPE B))

Measuring range (Ω)	Resolution (Ω)	Accuracy
0.0 ÷ 19.9	0.1	$\pm(5\%$ of reading + 3 digits)
20 ÷ 1999	1	

Open-circuit voltage6.5 VDC ÷ 9 VDC
 Short-circuit currentmax. 8.5 mA
 Test lead compensationup to 5 Ω

9.3 RCD testing

Note:

All data (marked with “*”) regarding B type RCDs are valid for model TESTBOY TV 450 (TYPE B) only.

9.3.1 General data

Nominal residual current (A,AC)10 mA, 30 mA, 100 mA, 300 mA, 500 mA,
 1000 mA
 Nominal residual current accuracy.....-0 / +0.1 \cdot I Δ ; I Δ = I Δ N, 2 \times I Δ N, 5 \times I Δ N
 -0.1 \cdot I Δ / +0; I Δ = 0.5 \times I Δ N
 AS / NZ selected: $\pm 5\%$
 Test current shapeSine-wave (AC), pulsed (A), smooth DC (B)*
 DC offset for pulsed test current6 mA (typical)
 RCD typeG (non-delayed), S (time-delayed)
 Test current starting polarity0° or 180°
 Voltage range50 V ÷ 264 V (45 Hz ÷ 65 Hz)

I _{ΔN} (mA)	I _{ΔN} × 1/2			I _{ΔN} × 1			I _{ΔN} × 2			I _{ΔN} × 5			RCD I _Δ		
	AC	A	B*	AC	A	B*	AC	A	B	AC	A	B*	AC	A	B*
10	5	3.5	5	10	20	20	20	40	40	50	100	100	✓	✓	✓
30	15	10.5	15	30	42	60	60	84	120	150	212	300	✓	✓	✓
100	50	35	50	100	141	200	200	282	400	500	707	1000	✓	✓	✓
300	150	105	150	300	424	600	600	848	n.a.	1500	n.a.	n.a.	✓	✓	✓
500	250	175	250	500	707	1000	1000	1410	n.a.	2500	n.a.	n.a.	✓	✓	✓
1000	500	350	500	1000	1410	n.a.	2000	n.a.	n.a.	n.a.	n.a.	n.a.	✓	✓	n.a.

n.a.....not applicable

AC type.....sine wave test current

A type.....pulsed current

B type.....smooth DC current

9.3.2 Contact voltage RCD-Uc

Measuring range according to EN61557 is 20.0 V ÷ 31.0V for limit contact voltage 25V

Measuring range according to EN61557 is 20.0 V ÷ 62.0V for limit contact voltage 50V

Measuring range (V)	Resolution (V)	Accuracy
0.0 ÷ 19.9	0.1	(-0 % / +15 %) of reading ± 10 digits
20.0 ÷ 99.9		(-0 % / +15 %) of reading

The accuracy is valid if mains voltage is stable during the measurement and PE terminal is free of interfering voltages.

Test current max. $0.5 \times I_{\Delta N}$

Limit contact voltage 25 V, 50 V

Specified accuracy is valid for complete operating range.

9.3.3 Trip-out time

Complete measurement range corresponds to EN 61557 requirements.

Maximum measuring times set according to selected reference for RCD testing.

Measuring range (ms)	Resolution (ms)	Accuracy
0.0 ÷ 40.0	0.1	±1 ms
0.0 ÷ max. time *	0.1	±3 ms

* For max. time see normative references in 4.2.5 – this specification applies to max. time >40 ms.

Test current $\frac{1}{2} \times I_{\Delta N}$, $I_{\Delta N}$, $2 \times I_{\Delta N}$, $5 \times I_{\Delta N}$

$5 \times I_{\Delta N}$ is not available for $I_{\Delta N}=1000$ mA (RCD type AC) or $I_{\Delta N} \geq 300$ mA (RCD types A, B*).

$2 \times I_{\Delta N}$ is not available for $I_{\Delta N}=1000$ mA (RCD type A) or $I_{\Delta N} \geq 300$ mA (RCD type B*).

$1 \times I_{\Delta N}$ is not available for $I_{\Delta N}=1000$ mA (RCD type B*).

Specified accuracy is valid for complete operating range.

9.3.4 Trip-out current

Trip-out current

Complete measurement range corresponds to EN 61557 requirements.

Measuring range I _Δ	Resolution I _Δ	Accuracy
$0.2 \times I_{\Delta N} \div 1.1 \times I_{\Delta N}$ (AC type)	$0.05 \times I_{\Delta N}$	$\pm 0.1 \times I_{\Delta N}$
$0.2 \times I_{\Delta N} \div 1.5 \times I_{\Delta N}$ (A type, $I_{\Delta N} \geq 30$ mA)	$0.05 \times I_{\Delta N}$	$\pm 0.1 \times I_{\Delta N}$

$0.2 \times I_{\Delta N} \div 2.2 \times I_{\Delta N}$ (A type, $I_{\Delta N} < 30$ mA)	$0.05 \times I_{\Delta N}$	$\pm 0.1 \times I_{\Delta N}$
$0.2 \times I_{\Delta N} \div 2.2 \times I_{\Delta N}$ (B type)*	$0.05 \times I_{\Delta N}$	$\pm 0.1 \times I_{\Delta N}$

Trip-out time

Measuring range (ms)	Resolution (ms)	Accuracy
0 ÷ 300	1	±3 ms

Contact voltage

Measuring range (V)	Resolution (V)	Accuracy
0.0 ÷ 19.9	0.1	(-0 % / +15 %) of reading ± 10 digits
20.0 ÷ 99.9	0.1	(-0 % / +15 %) of reading

The accuracy is valid if mains voltage is stable during the measurement and PE terminal is free of interfering voltages.

Trip-out measurement is not available for $I_{\Delta N} = 1000$ mA (RCD type B)*.

Specified accuracy is valid for complete operating range.

9.4 Fault loop impedance and prospective fault current

9.4.1 No disconnecting device or FUSE selected

Fault loop impedance

Measuring range according to EN61557 is $0.25 \Omega \div 9.99 \text{ k}\Omega$.

Measuring range (Ω)	Resolution (Ω)	Accuracy
0.00 ÷ 9.99	0.01	±(5 % of reading + 5 digits)
10.0 ÷ 99.9	0.1	
100 ÷ 999	1	± 10 % of reading
1.00k ÷ 9.99k	10	

Prospective fault current (calculated value)

Measuring range (A)	Resolution (A)	Accuracy
0.00 ÷ 9.99	0.01	Consider accuracy of fault loop resistance measurement
10.0 ÷ 99.9	0.1	
100 ÷ 999	1	
1.00k ÷ 9.99k	10	
10.0k ÷ 23.0k	100	

The accuracy is valid if mains voltage is stable during the measurement.

Test current (at 230 V)..... 6.5 A (10 ms)

Nominal voltage range..... 30 V ÷ 500 V (45 Hz ÷ 65 Hz)

9.4.2 RCD selected

Fault loop impedance

Measuring range according to EN61557 is 0.46 Ω ÷ 9.99 k Ω .

Measuring range (Ω)	Resolution (Ω)	Accuracy
0.00 ÷ 9.99	0.01	±(5 % of reading + 10 digits)
10.0 ÷ 99.9	0.1	
100 ÷ 999	1	± 10 % of reading
1.00k ÷ 9.99k	10	

Accuracy may be impaired in case of heavy noise on mains voltage

Prospective fault current (calculated value)

Measuring range (A)	Resolution (A)	Accuracy
0.00 ÷ 9.99	0.01	Consider accuracy of fault loop resistance measurement
10.0 ÷ 99.9	0.1	
100 ÷ 999	1	
1.00k ÷ 9.99k	10	
10.0k ÷ 23.0k	100	

Nominal voltage range..... 30 V ÷ 500 V (45 Hz ÷ 65 Hz)

No trip out of RCD.

R, XL values are indicative.

9.5 Line impedance and prospective short-circuit current

Line impedance

Measuring range according to EN61557 is 0.25 Ω ÷ 9.99k Ω .

Measuring range (Ω)	Resolution (Ω)	Accuracy
0.00 ÷ 9.99	0.01	±(5 % of reading + 5 digits)
10.0 ÷ 99.9	0.1	
100 ÷ 999	1	± 10 % of reading
1.00k ÷ 9.99k	10	

Prospective short-circuit current (calculated value)

Measuring range (A)	Resolution (A)	Accuracy
0.00 ÷ 0.99	0.01	Consider accuracy of line resistance measurement
1.0 ÷ 99.9	0.1	
100 ÷ 999	1	
1.00k ÷ 99.99k	10	
100k ÷ 199k	1000	

Test current (at 230 V)..... 6.5 A (10 ms)

Nominal voltage range..... 30 V ÷ 500 V (45 Hz ÷ 65 Hz)

R, XL values are indicative.

9.6 Resistance to earth (model TESTBOY TV 450 (TYPE B))

Measuring range according to EN61557-5 is $2.00 \Omega \div 1999 \Omega$.

Measuring range (Ω)	Resolution (Ω)	Accuracy
0.00 \div 19.99	0.01	$\pm(5\%$ of reading + 5 digits)
20.0 \div 199.9	0.1	
200 \div 9999	1	

Max. auxiliary earth electrode resistance R_C ... $100 \times R_E$ or $50 \text{ k}\Omega$ (whichever is lower)

Max. probe resistance R_P $100 \times R_E$ or $50 \text{ k}\Omega$ (whichever is lower)

Additional probe resistance error at $R_{C\text{max}}$ or $R_{P\text{max}}$. $\pm(10 \%$ of reading + 10 digits)

Additional error

at 3 V voltage noise (50 Hz) $\pm(5 \%$ of reading + 10 digits)

Open circuit voltage $< 15 \text{ VAC}$

Short circuit voltage $< 30 \text{ mA}$

Test voltage frequency 125 Hz

Test voltage shape rectangular

Noise voltage indication threshold $1 \text{ V} (< 50 \Omega, \text{ worst case})$

Automatic measurement of auxiliary electrode resistance and probe resistance.

Automatic measurement of voltage noise.

9.7 Voltage, frequency, and phase rotation

9.7.1 Phase rotation

Nominal system voltage range $100 \text{ V}_{AC} \div 550 \text{ V}_{AC}$

Nominal frequency range..... $14 \text{ Hz} \div 500 \text{ Hz}$

Result displayed 1.2.3 or 3.2.1

9.7.2 Voltage

Measuring range (V)	Resolution (V)	Accuracy
0 \div 550	1	$\pm(2 \%$ of reading + 2 digits)

Result type..... True r.m.s. (trms)

Nominal frequency range..... $0 \text{ Hz}, 14 \text{ Hz} \div 500 \text{ Hz}$

9.7.3 Frequency

Measuring range (Hz)	Resolution (Hz)	Accuracy
0.00 \div 9.99	0.01	$\pm(0.2 \%$ of reading + 1 digit)
10.0 \div 499.9	0.1	

Nominal voltage range..... $10 \text{ V} \div 550 \text{ V}$

9.7.4 Online terminal voltage monitor

Measuring range (V)	Resolution (V)	Accuracy
10 ÷ 550	1	±(2 % of reading + 2 digits)

9.8 General data

Models TESTBOY TV 450 and TESTBOY TV 450 (TYPE B):

Power supply voltage.....	9 V _{DC} (6×1.5 V battery or accu, size AA)
Operation.....	typical 20 h
Charger socket input voltage	12 V ± 10 %
Charger socket input current	400 mA max.
Battery charging current	250 mA (internally regulated)
Overvoltage category.....	600 V CAT III / 300 V CAT IV
Plug commander	
overvoltage category.....	300 V CAT III
Protection classification	double insulation
Pollution degree.....	2
Protection degree	IP 40

Display 128x64 dots matrix display with backlight

Dimensions (w × h × d)..... 14 cm × 8 cm × 23 cm
 Weight 1.0 kg, without battery cells

Reference conditions

Reference temperature range..... 10 °C ÷ 30 °C
 Reference humidity range..... 40 %RH ÷ 70 %RH

Operation conditions

Working temperature range

0 °C ÷ 40 °C

Maximum relative humidity

95 %RH (0 °C ÷ 40 °C), non-condensing

Storage conditions

Temperature range..... -10 °C ÷ +70 °C
 Maximum relative humidity

90 %RH (-10 °C ÷ +40 °C)
80 %RH (40 °C ÷ 60 °C)

Model TESTBOY TV 450 (TYPE B):

Communication transfer speed

RS 232 115200 baud

USB 256000 baud

Memory size.....1700 results

The error in operating conditions could be at most the error for reference conditions (specified in the manual for each function) +1 % of measured value + 1 digit, unless otherwise specified in the manual for particular function.

A Appendix A - Fuse table

A.1 Fuse table - IPSC

Fuse type NV

Rated current (A)	Disconnection time [s]				
	35m	0.1	0.2	0.4	5
	Min. prospective short-circuit current (A)				
2	32.5	22.3	18.7	15.9	9.1
4	65.6	46.4	38.8	31.9	18.7
6	102.8	70	56.5	46.4	26.7
10	165.8	115.3	96.5	80.7	46.4
16	206.9	150.8	126.1	107.4	66.3
20	276.8	204.2	170.8	145.5	86.7
25	361.3	257.5	215.4	180.2	109.3
35	618.1	453.2	374	308.7	169.5
50	919.2	640	545	464.2	266.9
63	1217.2	821.7	663.3	545	319.1
80	1567.2	1133.1	964.9	836.5	447.9
100	2075.3	1429	1195.4	1018	585.4
125	2826.3	2006	1708.3	1454.8	765.1
160	3538.2	2485.1	2042.1	1678.1	947.9
200	4555.5	3488.5	2970.8	2529.9	1354.5
250	6032.4	4399.6	3615.3	2918.2	1590.6
315	7766.8	6066.6	4985.1	4096.4	2272.9
400	10577.7	7929.1	6632.9	5450.5	2766.1
500	13619	10933.5	8825.4	7515.7	3952.7
630	19619.3	14037.4	11534.9	9310.9	4985.1
710	19712.3	17766.9	14341.3	11996.9	6423.2
800	25260.3	20059.8	16192.1	13545.1	7252.1
1000	34402.1	23555.5	19356.3	16192.1	9146.2
1250	45555.1	36152.6	29182.1	24411.6	13070.1

Fuse type gG

Rated current (A)	Disconnection time [s]				
	35m	0.1	0.2	0.4	5
	Min. prospective short-circuit current (A)				
2	32.5	22.3	18.7	15.9	9.1
4	65.6	46.4	38.8	31.9	18.7
6	102.8	70	56.5	46.4	26.7
10	165.8	115.3	96.5	80.7	46.4
13	193.1	144.8	117.9	100	56.2
16	206.9	150.8	126.1	107.4	66.3
20	276.8	204.2	170.8	145.5	86.7
25	361.3	257.5	215.4	180.2	109.3
32	539.1	361.5	307.9	271.7	159.1
35	618.1	453.2	374	308.7	169.5
40	694.2	464.2	381.4	319.1	190.1

50	919.2	640	545	464.2	266.9
63	1217.2	821.7	663.3	545	319.1
80	1567.2	1133.1	964.9	836.5	447.9
100	2075.3	1429	1195.4	1018	585.4

Fuse type B

Rated current (A)	Disconnection time [s]				
	35m	0.1	0.2	0.4	5
	Min. prospective short-circuit current (A)				
6	30	30	30	30	30
10	50	50	50	50	50
13	65	65	65	65	65
16	80	80	80	80	80
20	100	100	100	100	100
25	125	125	125	125	125
32	160	160	160	160	160
40	200	200	200	200	200
50	250	250	250	250	250
63	315	315	315	315	315

Fuse type C

Rated current (A)	Disconnection time [s]				
	35m	0.1	0.2	0.4	5
	Min. prospective short-circuit current (A)				
0.5	5	5	5	5	2.7
1	10	10	10	10	5.4
1.6	16	16	16	16	8.6
2	20	20	20	20	10.8
4	40	40	40	40	21.6
6	60	60	60	60	32.4
10	100	100	100	100	54
13	130	130	130	130	70.2
16	160	160	160	160	86.4
20	200	200	200	200	108
25	250	250	250	250	135
32	320	320	320	320	172.8
40	400	400	400	400	216
50	500	500	500	500	270
63	630	630	630	630	340.2

Fuse type K

Rated current (A)	Disconnection time [s]				
	35m	0.1	0.2	0.4	
	Min. prospective short-circuit current (A)				
0.5	7.5	7.5	7.5	7.5	
1	15	15	15	15	
1.6	24	24	24	24	
2	30	30	30	30	

4	60	60	60	60	
6	90	90	90	90	
10	150	150	150	150	
13	195	195	195	195	
16	240	240	240	240	
20	300	300	300	300	
25	375	375	375	375	
32	480	480	480	480	

Fuse type D

Rated current (A)	Disconnection time [s]				
	35m	0.1	0.2	0.4	5
	Min. prospective short-circuit current (A)				
0.5	10	10	10	10	2.7
1	20	20	20	20	5.4
1.6	32	32	32	32	8.6
2	40	40	40	40	10.8
4	80	80	80	80	21.6
6	120	120	120	120	32.4
10	200	200	200	200	54
13	260	260	260	260	70.2
16	320	320	320	320	86.4
20	400	400	400	400	108
25	500	500	500	500	135
32	640	640	640	640	172.8

A.2 Fuse table - impedances (UK)**Fuse type B****Fuse type C**

Rated current (A)	Disconnection time [s]		Rated current (A)	Disconnection time [s]			
		0.4		5		0.4	5
	Max. loop impedance (Ω)			Max. loop impedance (Ω)			
3		12,264	12,264				
6		6,136	6,136	6	3,064	3,064	
10		3,68	3,68	10	1,84	1,84	
16		2,296	2,296	16	1,152	1,152	
20		1,84	1,84	20	0,92	0,92	
25		1,472	1,472	25	0,736	0,736	
32		1,152	1,152	32	0,576	0,576	
40		0,92	0,92	40	0,456	0,456	
50		0,736	0,736	50	0,368	0,368	
63		0,584	0,584	63	0,288	0,288	
80		0,456	0,456	80	0,232	0,232	
100		0,368	0,368	100	0,184	0,184	
125		0,296	0,296	125	0,144	0,144	

Fuse type D

Rated current (A)	Disconnection time [s]	
	0.4	5
	Max. loop impedance (Ω)	
6	1,536	1,536
10	0,92	0,92
16	0,576	0,576
20	0,456	0,456
25	0,368	0,368
32	0,288	0,288
40	0,232	0,232
50	0,184	0,184
63	0,144	0,144
80	0,112	0,112
100	0,088	0,088
125	0,072	0,072

Fuse type BS 1361

Rated current (A)	Disconnection time [s]	
	0.4	5
	Max. loop impedance (Ω)	
5	8,36	13,12
15	2,624	4
20	1,36	2,24
30	0,92	1,472
45		0,768
60		0,56
80		0,4
100		0,288

Fuse type BS 88

Rated current (A)	Disconnection time [s]	
	0.4	5
	Max. loop impedance (Ω)	
6	6,816	10,8
10	4,088	5,936
16	2,16	3,344
20	1,416	2,328
25	1,152	1,84
32	0,832	1,472
40		1,08
50		0,832
63		0,656
80		0,456
100		0,336
125		0,264
160		0,2
200		0,152

Fuse type BS 1362

Rated current (A)	Disconnection time [s]	
	0.4	5
	Max. loop impedance (Ω)	
3	13,12	18,56
13	1,936	3,064

Fuse type BS 3036		
Rated current (A)	Disconnection time [s]	
	0.4	5
	Max. loop impedance (Ω)	
5	7,664	14,16
15	2,04	4,28
20	1,416	3,064
30	0,872	2,112
45		1,272
60		0,896
100		0,424

All impedances are scaled with factor 0.8.

B Appendix B - Accessories for specific measurements

The table below presents standard and optional accessories required for specific measurement. The accessories marked as optional may also be standard ones in some sets. Please see attached list of standard accessories for your set or contact your distributor for further information.

Function	Suitable accessories (Optional with ordering code A....)
Insulation resistance	<input type="checkbox"/> Test lead, 3 x 1.5 m <input type="checkbox"/> Tip commander (A 1270)
R LOW Ω resistance	<input type="checkbox"/> Test lead, 3 x 1.5 m <input type="checkbox"/> Tip commander (A 1270) <input type="checkbox"/> Test lead, 4 m (A 1012)
Continuous resistance measurement (model TESTBOY TV 450 (TYPE B))	<input type="checkbox"/> Test lead, 3 x 1.5 m <input type="checkbox"/> Tip commander (A 1270) <input type="checkbox"/> Test lead, 4 m (A 1012)
Line impedance	<input type="checkbox"/> Test lead, 3 x 1.5 m <input type="checkbox"/> Plug commander (A 1272) <input type="checkbox"/> Mains measuring cable <input type="checkbox"/> Tip commander (A 1270) <input type="checkbox"/> Three-phase adapter with switch (A 1111)
Fault loop impedance	<input type="checkbox"/> Test lead, 3 x 1.5 m <input type="checkbox"/> Plug commander (A 1272) <input type="checkbox"/> Mains measuring cable <input type="checkbox"/> Tip commander (A 1270) <input type="checkbox"/> Three-phase adapter with switch (A 1111)
RCD testing	<input type="checkbox"/> Test lead, 3 x 1.5 m <input type="checkbox"/> Plug commander (A 1272) <input type="checkbox"/> Mains measuring cable <input type="checkbox"/> Three-phase adapter with switch (A 1111)
Earth resistance, RE (model TESTBOY TV 450 (TYPE B))	<input type="checkbox"/> Earth test set, 3-wire, 20 m (S 2026) <input type="checkbox"/> Earth test set, 3-wire, 50 m (S 2027)
Phase sequence	<input type="checkbox"/> Test lead, 3 x 1.5 m <input type="checkbox"/> Three-phase adapter (A 1110) <input type="checkbox"/> Three-phase adapter with switch (A 1111)
Voltage, frequency	<input type="checkbox"/> Test lead, 3 x 1.5 m <input type="checkbox"/> Plug commander (A 1272) <input type="checkbox"/> Mains measuring cable <input type="checkbox"/> Tip commander (A 1270)

C Appendix F – Country notes

This appendix F contains collection of minor modifications related to particular country requirements. Some of the modifications mean modified listed function characteristics related to main chapters and others are additional functions. Some minor modifications are related also to different requirements of the same market that are covered by various suppliers.

C.1 List of country modifications

The following table contains current list of applied modifications.

Country	Related chapters	Modification type	Note
AT	5.4, 9.3, C.2.1	Appended	Special G type RCD

C.2 Modification issues







C.2.1 AT modification - G type RCD

Modified is the following related to the mentioned in the chapter 5.4:

- G type mentioned in the chapter is converted to unmarked type ,
- Added G type RCD,
- Time limits are the same as for general type RCD,
- Contact voltage is calculated the same as for general type RCD.

Modifications of the chapter 5.4

Test parameters for RCD test and measurement



TEST	RCD sub-function test [RCDt, RCD I, AUTO, Uc].
I δ n	Rated RCD residual current sensitivity I Δ N [10 mA, 30 mA, 100 mA, 300 mA, 500 mA, 1000 mA].
type	RCD type [<input type="checkbox"/> , <input type="checkbox"/> G, <input type="checkbox"/> S], test current waveform plus starting polarity [ , ^{180°}  ,  , ^{180°}  ,  *,  *].
MUL	Multiplication factor for test current [$\frac{1}{2}$, 1, 2, 5 I δ n].
Ulim	Conventional touch voltage limit [25 V, 50 V].

* Model TESTBOY TV 450 (TYPE B)

Note:

- Ulim can be selected in the Uc sub-function only.

The instrument is intended for testing of general , G (non-delayed) and selective S (time-delayed) RCDs, which are suited for:

- Alternating residual current (AC type, marked with  symbol),
- Pulsating residual current (A type, marked with  symbol).
- Model TESTBOY TV 450 (TYPE B): DC residual current (B type, marked with  symbol).

Time delayed RCDs demonstrate delayed response characteristics. They contain residual current integrating mechanism for generation of delayed trip out. However, contact voltage pre-test in the measuring procedure also influences the RCD and it takes a period to recover into idle state. Time delay of 30 s is inserted before performing trip-out test to recover S type RCD after pretests and time delay of 5 s is inserted for the same purpose for G type RCD.

Modification of the chapter 5.4.1

RCD type		Contact voltage U_c proportional to	Rated $I_{\Delta N}$		
AC	<input type="checkbox"/> G	$1.05 \times I_{\Delta N}$	any	Both models	
AC	<input type="checkbox"/> S	$2 \times 1.05 \times I_{\Delta N}$			
A	<input type="checkbox"/> G	$1.4 \times 1.05 \times I_{\Delta N}$	≥ 30 mA		
A	<input type="checkbox"/> S	$2 \times 1.4 \times 1.05 \times I_{\Delta N}$			
A	<input type="checkbox"/> G	$2 \times 1.05 \times I_{\Delta N}$	< 30 mA		
A	<input type="checkbox"/> S	$2 \times 2 \times 1.05 \times I_{\Delta N}$			
B	<input type="checkbox"/>	$2 \times 1.05 \times I_{\Delta N}$	any		Model TESTBOY TV 450 (Type B) only
B	<input type="checkbox"/> S	$2 \times 2 \times 1.05 \times I_{\Delta N}$			

Table C.1: Relationship between U_c and $I_{\Delta N}$

Technical specifications remain the same.

