

VOLTMETER

EVM-3 / EVM-3C

Precautions For Installation and Safe Use

- Failure to follow those instructions will result in death or serious injury.
- Disconnect all power before working on equipment.
- When the device is connected to the network, do not remove the front panel.
- Do not try to clean the device with solvent or the like. Only clean the device with a dried cloth.
- Verify correct terminal connections when wiring.
- Electrical equipment should be serviced only by your compedent seller.
- Only for rack panel mounting.

⚠ No responsibility is assured by the manufacturer or any of its subsidiaries for any consequences arising out of the use of this material.

EVM-3 (Voltmeter) :

EVM-3 is designed for accurate measuring of the AC RMS voltage and for saving the minimum and maximum values of the measured voltages. Minimum and maximum values remain stored in the memory when the power supply is off. This stored values can be read when the power is on. Although EVM-3 is mainly used for electrical panels, this device can also be used with any application in which accurate voltage readings should be done between 10-600V. The measurement (3-4) and power supply (1-2) connections are located on the rear panel and the digital display is centered on the front panel.

EVM-3C (Setpoint Voltmeter) :

EVM-3C has the same functions of the EVM-3. In addition to these functions, an high voltage level and "time delay" can be set. When the measured voltage is over the high set point value, the output relay is activated at the end of the adjusted time delay, generates an alarm signal and display starts blinking.

Note: If the measurement that the device made or the primary value is over 9999 V, k led on the device is on.

Note: If the voltage on the measurement input of the device is over 600 V or measurement according to the ratio of entered primary/secondar is over 999.000 V, there will be "h" on the display.

Voltage Transformer Ratio: Voltage transformer can regulate the primary and secondary voltage values separately. Primary value can be entered between 1-40.000 and the secondary value can be entered between 1-250.

Note: If the primary and secondary values changed, control the setpoint and hysteresis values. This is important for the device working the way that it was arranged.

Minimum and Maximum Voltage :

The minimum and maximum voltage values are stored. User may read or delete these values. Stored minimum and maximum voltage values remain stored, when the power supply is off.

Setpoint (SP h ve SP L): When the AC current which flows through the device is over the high setpoint value or it is under the low setpoint value, the output relay is switched on in order to generate an error signal at the end of programmed delay time (The point which is on the below right corner of display blinks). If the AC current value returns within preset limits, before the end of the delay time, the relay resets itself and no tripping occurs.

Latch Function (LAtC) : Latch function is used to select the output relay operation mode. Either "oF" or "on" position may be selected.

- At position "oF": If the current value returns to preset limits, output relay is switched off.
- At position "on": Even if the current value returns to preset limits, output relay remains switched on and switches off only by pressing the "Set" button.

Instant Tripping (tRP) : If the AC current value is over the 1,5 times of setting value or it is under the 0,5 times of setting value, the output relay is switched on without any delay time. This function is user-selectable.

Setting of Voltage Transformer Primary Voltage Value (for EVM-3C)

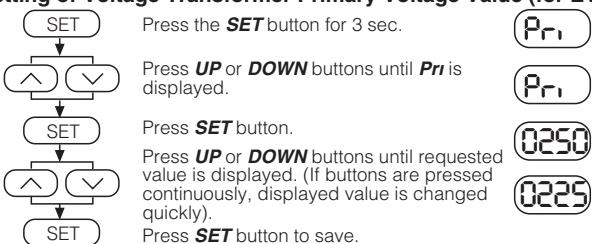

Setting of Voltage Transformer Secondary Voltage Value (for EVM-3C)

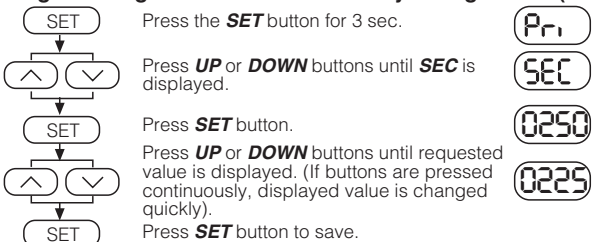

Setting of High Setpoint Value (for EVM-3C)

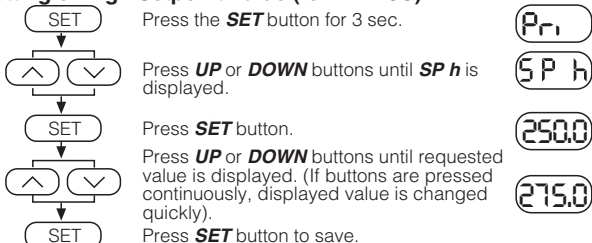

Setting of Low Setpoint Value (for EVM-3C)

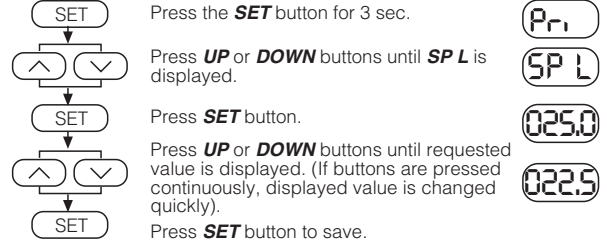

Setting of Hysteresis Value (for EVM-3C)

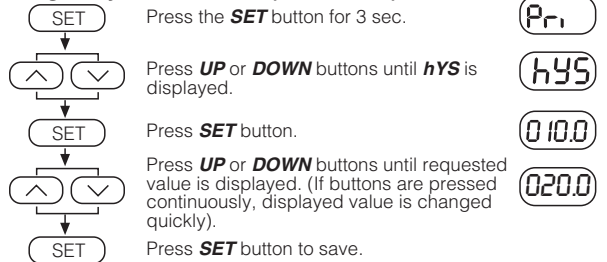

Setting of On Time Value (for EVM-3C)

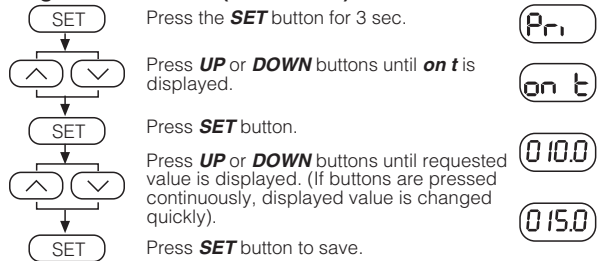

Setting of Off Time Value (EVM-3C için)

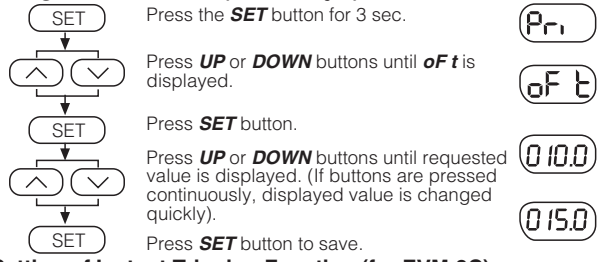

Setting of Instant Tripping Function (for EVM-3C)

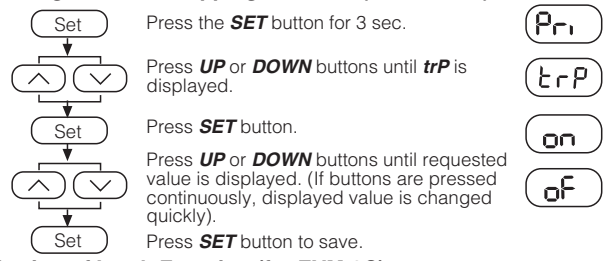

Setting of Latch Function (for EVM-3C)

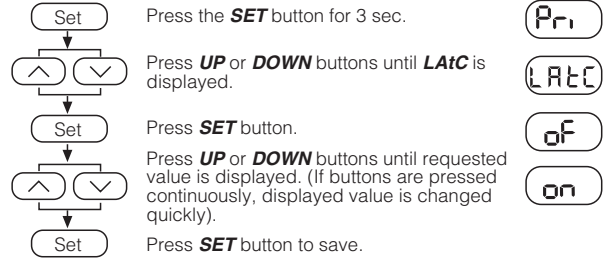

Displaying and Deleting Tripping Number (for EVM-3C)

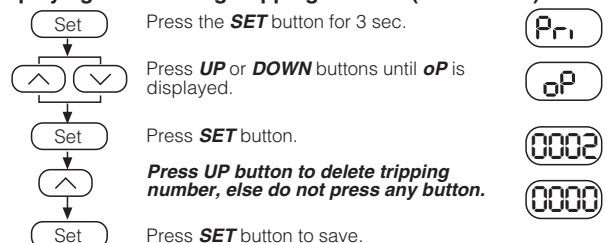

VOLTMETER EVM-3 / EVM-3C

Setting of Contact Situation (for EVM-3C)

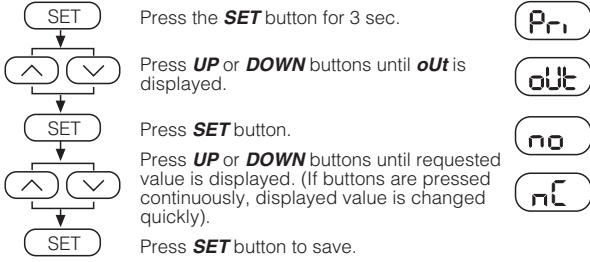

Escaping the Set Menu (for EVM-3C)



Displaying Minimum Voltage



Displaying Maximum Voltage

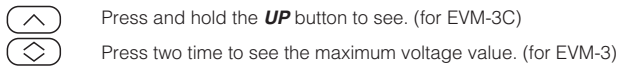

Deleting the Minimum and Maximum Voltages

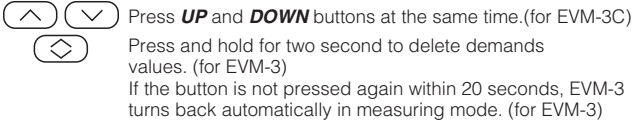

- The decimal point blinks while the display shows demand values (for EVM-3).

Factory Setting :

Voltage transformer primary voltage value (P _r)	: 0100
Voltage transformer secondary voltage value (S _E)	: 0100
High set point value (S _P h)	: 250.0
Low set point value (S _P l)	: 150.0
Hysteresis value (h _{YS})	: 010.0
On time (o _n t)	: 010.0
Off time (o _f t)	: 010.0
Instant tripping function (t _r -P)	: on
Latch function (L _A E _C)	: oF
Contact situation (o _U t)	: no (Normally open)

Connection Diagrams

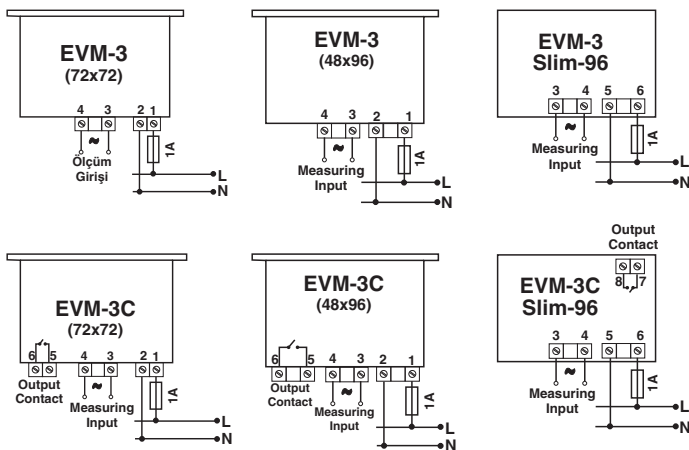

Warning :

- A switch or circuit breaker must be connected between the network and the auxiliary supply input of device.
- Connected switch or circuit breaker must be in close proximity to the device.
- Connected switch or circuit breaker must be marked as the disconnecting device for the equipment.
- The type of the used fuse must be FF type and the current of the used fuse must be 1A.
- No need of a ventilator in the installation area
- Do not use with generator.

Dimensions

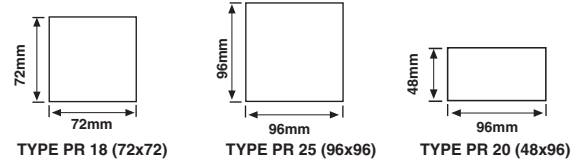

The Area Measurements on The Control Panel

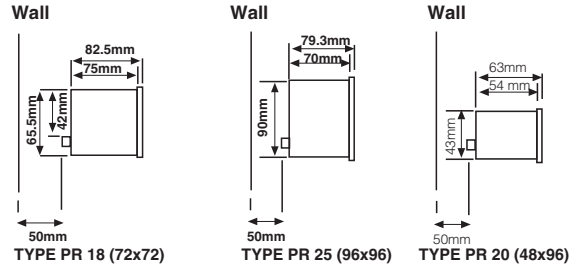

Control Panel Cut Out

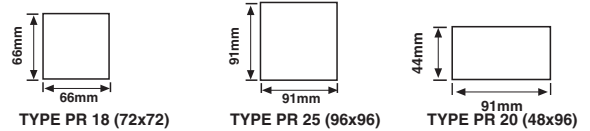

Technical Data

Operating Voltage (U _N)*	: Please look at labels on the device.
Operating Range(ΔU)	: 45-65 Hz
Operating Frequency(f)	: 1% ±1 digit [(%10-%100) full scale]
Accuracy	: 10-600 V AC (for EVM-3, EVM-3C)
Measuring Input (V _{IN})	: <4 VA
Power Consumption(P _{cons})	: 5 A, 250 V, 1250 VA (Resistive) (for EVM-3C)
Burden	: <1 VA (per phase)
Output Contact	: Voltage Transformer Ratio
Voltage Transformer Ratio	: Primary : 1-40000 (for EVM-3C)
	: Secondary : 1-250 (for EVM-3C)
Ins. Tripping	: >1.5 x SPH or <0.5 x SPL (for EVM-3C)
Hysteresis	: 0-0.5 x Full scale (for EVM-3C)
Delay Time	: 0.0 - 999.9 sec. (for EVM-3C)
Enclosure	: Non-flammable
Equipment Protection	: Double Insulation (□), Measuring CategoryIII
Ambient Temperature	: -5 °C; +50 °C
Degree of Protection	: IP 40 (Front Panel)
Installations	: Flush mounting with rear terminals
Wire Cross section (for terminals):	: 2.5 mm ²
Dimensions	: Type PR 18, PR 25, PR 20
Weight	: 0.28 kg (for PR 18)
	: 0.30 kg (for PR 25)
	: 0.25 kg (for PR 20)

Packaging Information

Pcs per Package	: 16 Pcs (for PR 18)
Package Weight	: 4.5 kg
Pcs per Package	: 12 Pcs (for PR 25)
Package Weight	: 3.6 kg
Pcs per Package	: 20 Pcs (for PR 20)
Package Weight	: 5 kg



- * Please check the device label for proper value.
- *Different supply voltages are adjustable upon request.

