

# HCPL-817

## Phototransistor Optocoupler High Density Mounting Type



### Data Sheet



**Lead (Pb) Free**  
RoHS 6 fully compliant

RoHS 6 fully compliant options available;  
-xxxE denotes a lead-free product

#### Description

The HCPL-817 contains a light emitting diode optically coupled to a phototransistor. It is packaged in a 4-pin DIP package and available in wide-lead spacing option and lead bend SMD option. Input-output isolation voltage is 5000 Vrms. Response time,  $t_r$ , is typically 4  $\mu$ s and minimum CTR is 50% at input current of 5 mA.

#### Schematic

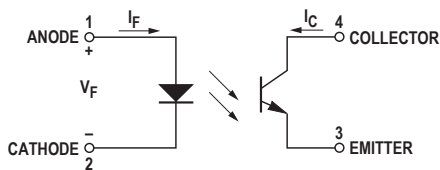

#### Functional Diagram

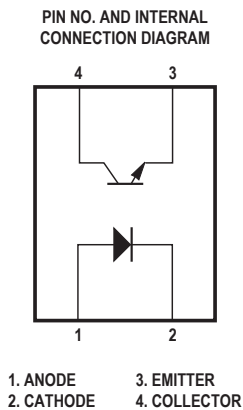

#### Features

- Current Transfer Ratio (CTR: min. 50% at  $I_F = 5$  mA,  $V_{CE} = 5$  V)
- High input-output isolation voltage ( $V_{ISO} = 5000$  V<sub>rms</sub>)
- Response time ( $t_r$ : typ., 4  $\mu$ s at  $V_{CE} = 2$  V,  $I_C = 2$  mA,  $R_L = 100$   $\Omega$ )
- Compact dual-in-line package
- UL approved
- CSA approved
- IEC/EN/DIN EN 60747-5-2 approved
- Options available:
  - Leads with 0.4" (10.16 mm) spacing (W00)
  - Leads bends for surface mounting (300)
  - Tape and reel for SMD (500)
  - IEC/EN/DIN EN 60747-5-2 approvals (060)

#### Applications

- Signal transmission between circuits of different potentials and impedances
- I/O interfaces for computers
- Feedback circuit in power supply

**CAUTION:** It is advised that normal static precautions be taken in handling and assembly of this component to prevent damage and/or degradation which may be induced by ESD.

## Ordering Information

:HCPL-817-xxxx is UL Recognized with 5000 Vrms for 1 minute per UL1577 and is approved under CSA Component Acceptance Notice #5, File CA 88324.

Part number	RoHS Compliant Option						Package	Surface Mount	Gull Wing	Tape & Reel	IEC/EN/DIN EN 60747-5-2	Quantity
	Rank '0'	Rank 'A'	Rank 'B'	Rank 'C'	Rank 'D'	Rank 'L' 50%						
	<CTR< 50%	<CTR< 80%	<CTR< 130%	<CTR< 200%	<CTR< 300%	<CTR< 600%						
	-000E	-00AE	-00BE	-00CE	-00DE	-00LE	300mil DIP-4					100 pcs per tube
	-300E	-30AE	-30BE	-30CE	-30DE	-30LE	300mil DIP-4	X	X			100 pcs per tube
	-500E	-50AE	-50BE	-50CE	-50DE	-50LE	300mil DIP-4	X	X	X		1000 pcs per reel
HCPL-817	-060E	-06AE	-06BE	-06CE	-06DE	-06LE	300mil DIP-4				X	100 pcs per tube
	-360E	-36AE	-36BE	-36CE	-36DE	-36LE	300mil DIP-4	X	X		X	100 pcs per tube
	-560E	-56AE	-56BE	-56CE	-56DE	-56LE	300mil DIP-4	X	X	X	X	1000 pcs per reel
	-W00E	-W0AE	-W0BE	-W0CE	-W0DE	-W0LE	400mil DIP-4					100 pcs per tube
	-W60E	-W6AE	-W6BE	-W6CE	-W6DE	-W6LE	400mil DIP-4				X	100 pcs per tube

To order, choose a part number from the part number column and combine with the desired option from the option column to form an order entry.

### Example 1:

HCPL-817-360E to order product of 300mil DIP-4 DC Gull Wing Surface Mount package in Tube packaging with 50%<CTR<600%, IEC/EN/DIN EN 60747-5-2 Safety Approval and RoHS compliant.

### Example 2:

HCPL-817-50BE to order product of 300mil DIP-4 DC Gull Wing Surface Mount package in Tape and Reel packaging with 130%<CTR<260% and RoHS compliant.

Option datasheets are available. Contact your Avago sales representative or authorized distributor for information.

**Package Outline Drawings**

**HCPL-817-000E**

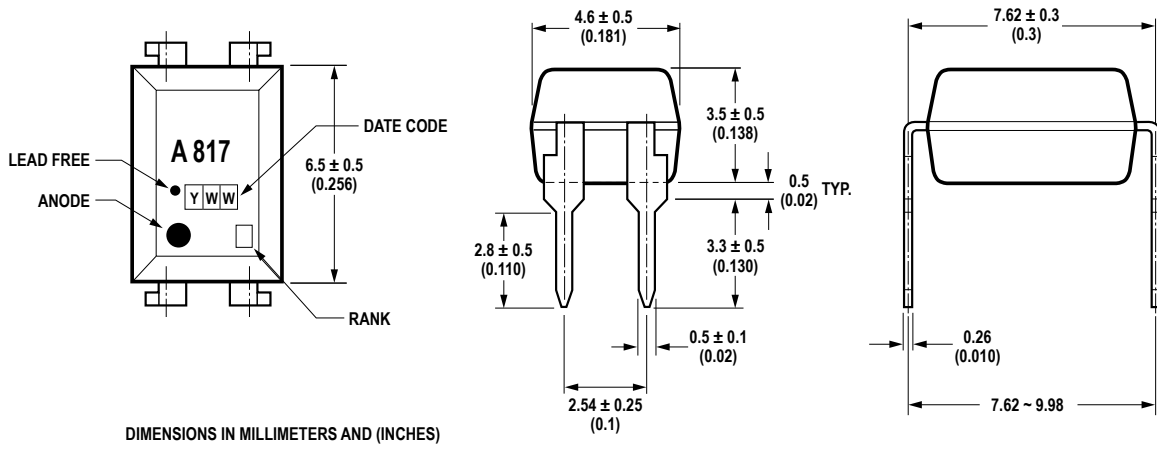

**HCPL-817-060E**

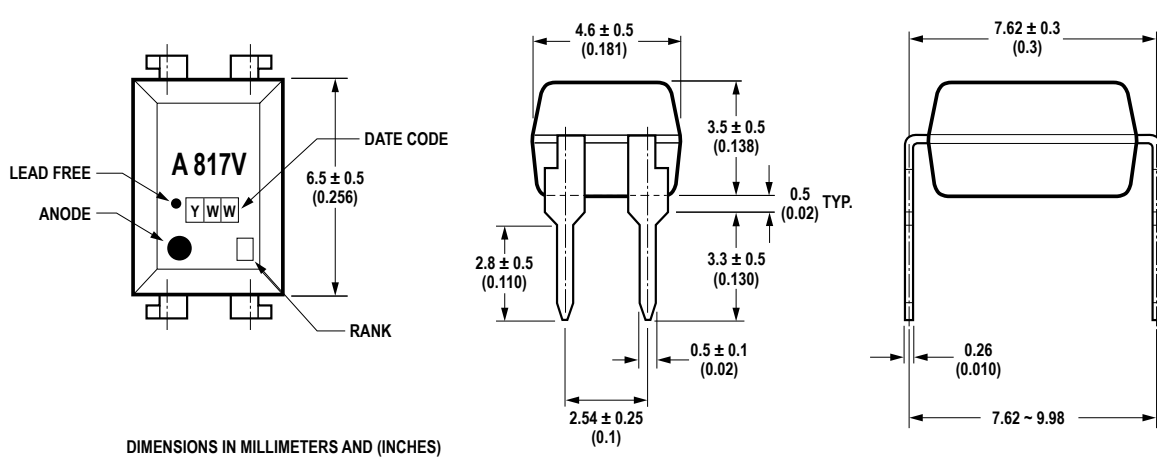

**HCPL-817-W00E**

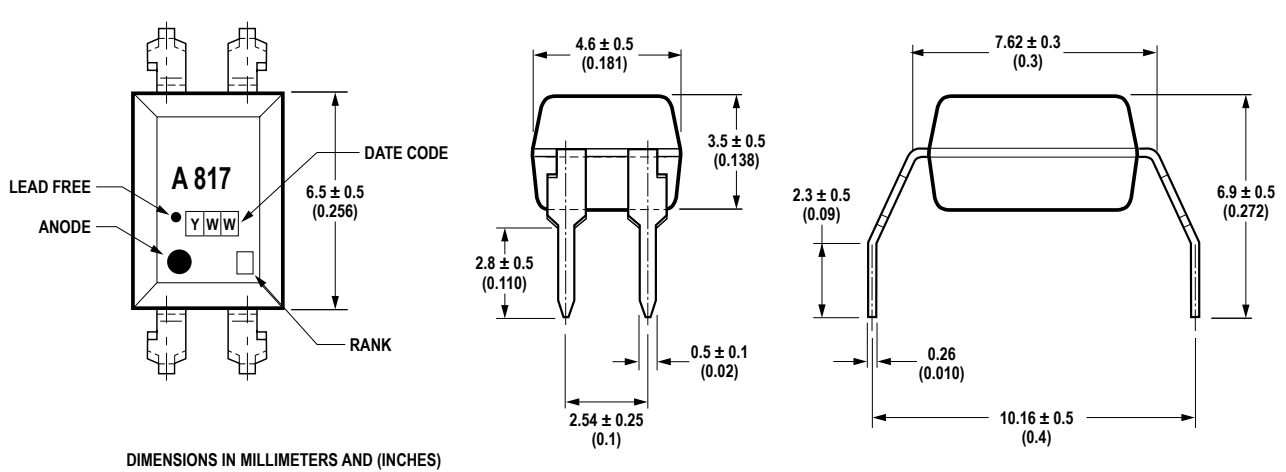

## HCPL-817-300E

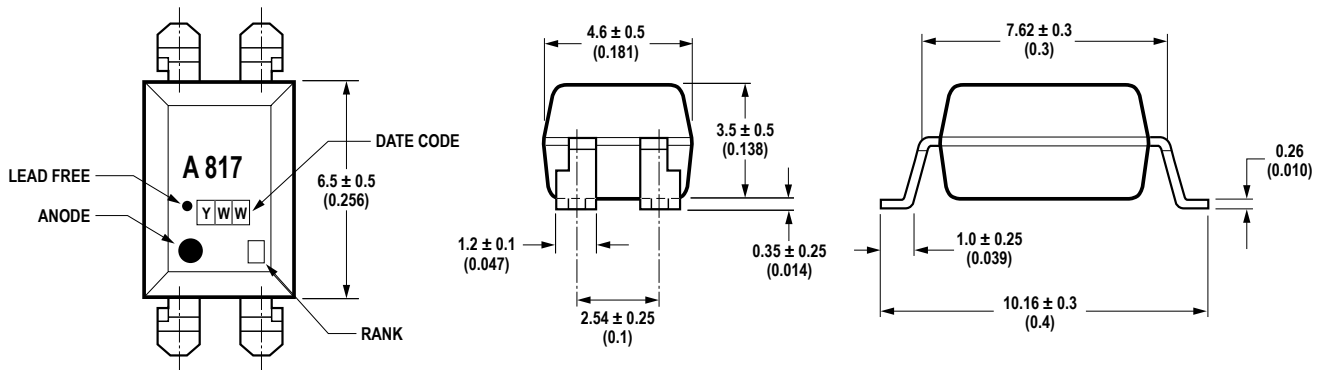

DIMENSIONS IN MILLIMETERS AND (INCHES)

### Solder Reflow Temperature Profile

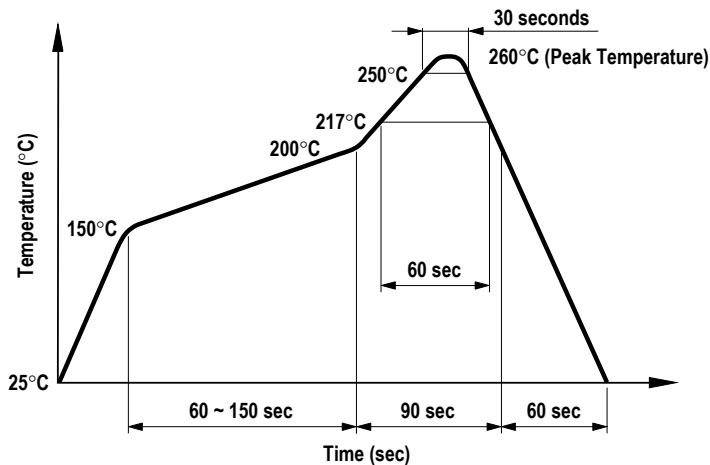

- 1) One-time soldering reflow is recommended within the condition of temperature and time profile shown.
- 2) When using another soldering method such as infrared ray lamp, the temperature may rise partially in the mold of the device. Keep the temperature on the package of the device within the condition of (1) above.

Note: Non-halide flux should be used.

### Absolute Maximum Ratings ( $T_A = 25^\circ\text{C}$ )

Storage Temperature, $T_S$	$-55^\circ\text{C}$ to $+125^\circ\text{C}$
Operating Temperature, $T_A$	$-30^\circ\text{C}$ to $+100^\circ\text{C}$
Lead Solder Temperature, max. (1.6 mm below seating plane)	$260^\circ\text{C}$ for 10 s
Average Forward Current, $I_F$	50 mA
Reverse Input Voltage, $V_R$	6 V
Input Power Dissipation, $P_I$	70 mW
Collector Current, $I_C$	50 mA
Collector-Emitter Voltage, $V_{CEO}$	70 V
Emitter-Collector Voltage, $V_{ECO}$	6 V
Collector Power Dissipation	150 mW
Total Power Dissipation	200 mW
Isolation Voltage, $V_{ISO}$ (AC for 1 minute, R.H. = 40 ~ 60%)	5000 Vrms

### Electrical Specifications ( $T_A = 25^\circ\text{C}$ )

Parameter	Symbol	Min.	Typ.	Max.	Units	Test Conditions
Forward Voltage	$V_F$	–	1.2	1.4	V	$I_F = 20\text{ mA}$
Reverse Current	$I_R$	–	–	10	$\mu\text{A}$	$V_R = 4\text{ V}$
Terminal Capacitance	$C_t$	–	30	250	pF	$V = 0, f = 1\text{ KHz}$
Collector Dark Current	$I_{CEO}$	–	–	100	nA	$V_{CE} = 20\text{ V}$
Collector-Emitter Breakdown Voltage	$BV_{CEO}$	70	–	–	V	$I_C = 0.1\text{ mA}$
Emitter-Collector Breakdown Voltage	$BV_{ECO}$	6	–	–	V	$I_E = 10\ \mu\text{A}$
Collector Current	$I_C$	2.5	–	30	mA	$I_F = 5\text{ mA}, V_{CE} = 5\text{ V},$
*Current Transfer Ratio	CTR	50	–	600	%	$R_{BE} = \infty$
Collector-Emitter Saturation Voltage	$V_{CE(sat)}$	–	0.1	0.2	V	$I_F = 20\text{ mA}, I_C = 1\text{ mA}$
Response Time (Rise)	$t_r$	–	4	18	$\mu\text{s}$	$V_{CC} = 2\text{ V}, I_C = 2\text{ mA}$
Response Time (Fall)	$t_f$	–	3	18	$\mu\text{s}$	$R_L = 100\ \Omega$
Cut-off Frequency	$f_c$	–	80	–	KHz	$V_{CC} = 5\text{ V}, I_C = 2\text{ mA}$ $R_L = 100\ \Omega, -3\text{ dB}$
Isolation Resistance	$R_{iso}$	$5 \times 10^{10}$	$1 \times 10^{11}$	–	$\Omega$	DC 500 V 40 ~ 60% R.H.
Floating Capacitance	$C_f$	–	0.6	1.0	pF	$V = 0, f = 1\text{ MHz}$

\*  $CTR = \frac{I_C}{I_F} \times 100\%$

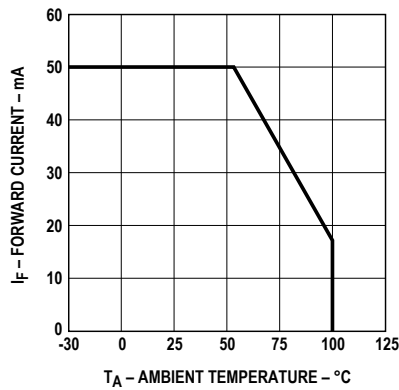

Figure 1. Forward current vs. temperature.

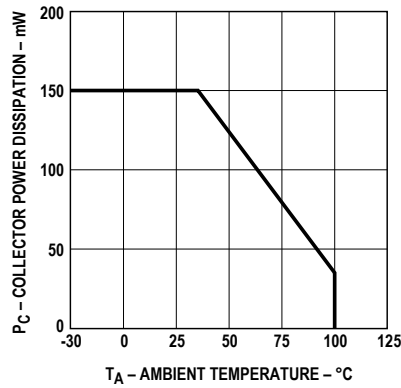

Figure 2. Collector power dissipation vs. temperature.

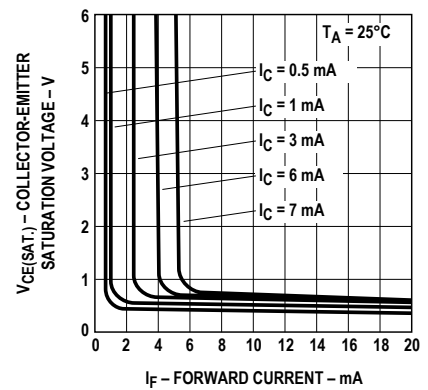

Figure 3. Collector-emitter saturation voltage vs. forward current.

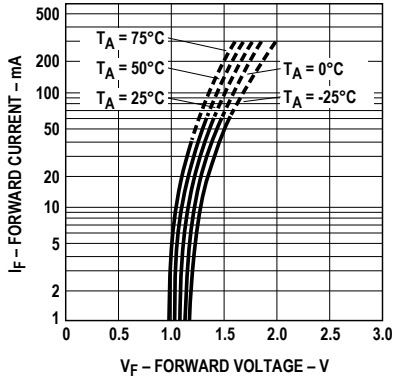

Figure 4. Forward current vs. forward voltage.

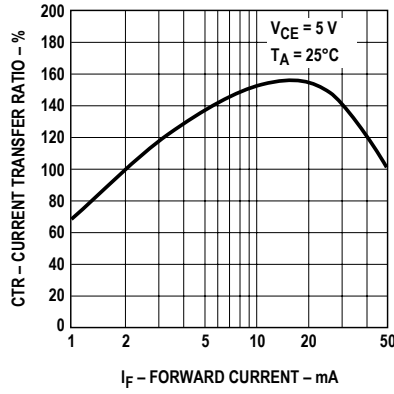

Figure 5. Current transfer ratio vs. forward current.

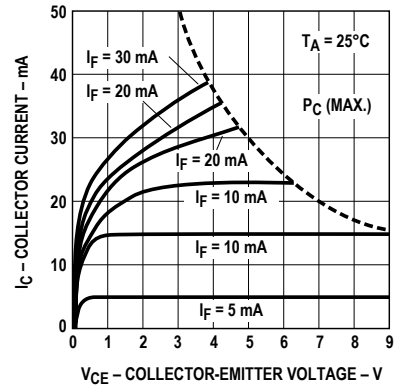

Figure 6. Collector current vs. collector-emitter voltage.

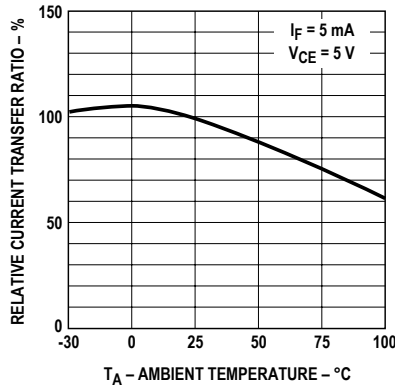

Figure 7. Relative current transfer ratio vs. temperature.

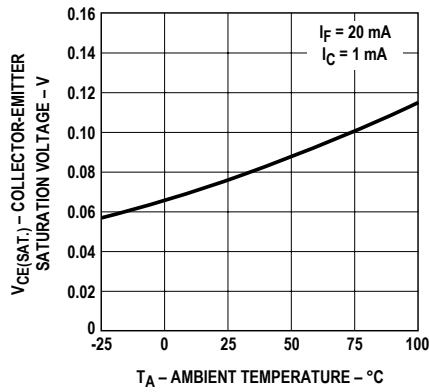

Figure 8. Collector-emitter saturation voltage vs. temperature.

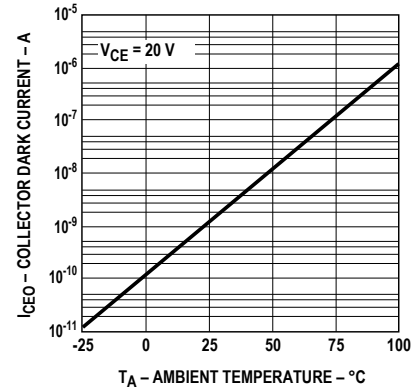

Figure 9. Collector dark current vs. temperature.

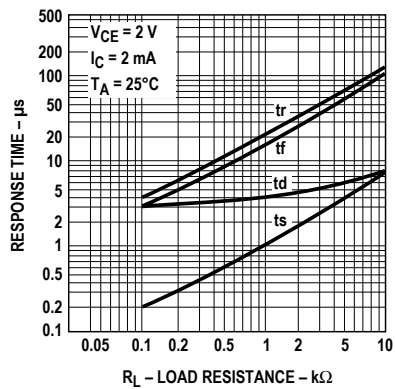

Figure 10. Response time vs. load resistance.

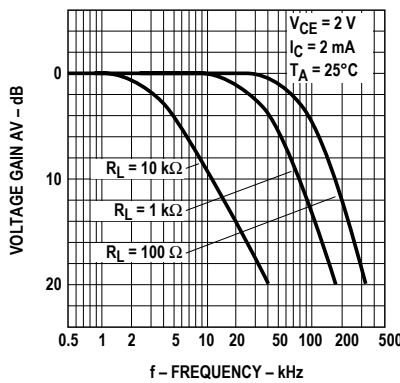
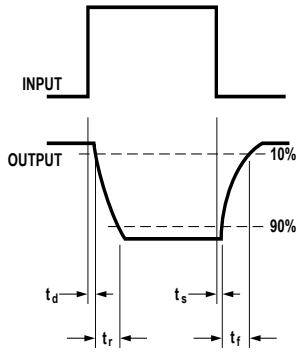
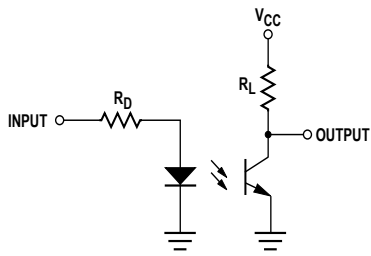
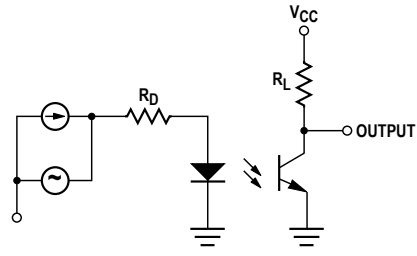

Figure 11. Frequency response.

### Test Circuit for Response Time



### Test Circuit for Frequency Response



For product information and a complete list of distributors, please go to our website: [www.avagotech.com](http://www.avagotech.com)

Avago, Avago Technologies, and the A logo are trademarks of Avago Technologies Limited in the United States and other countries. Data subject to change. Copyright © 2007 Avago Technologies Limited. All rights reserved. Obsoletes AV01-0534EN AV02-0265EN - October 18, 2007

**AVAGO**  
TECHNOLOGIES