

CNY17-x

Phototransistor Optocoupler High Collector-Emitter Voltage Type



Data Sheet

Description

The CNY17 contains a light emitting diode optically coupled to a photo-transistor. It is packaged in a 6-pin DIP package and available in wide-lead spacing option and lead bend SMD option. Collector-emitter voltage is above 70 V. Response time, t_r , is typically 5 μ s and minimum CTR is 40% at input current of 10 mA.

Applications

- System appliances, measuring instruments
- Signal transmission between circuits of different potentials and impedances
- Feedback circuit in power supply

Functional Diagram



Features

- High collector-emitter voltage ($V_{CE0} = 70$ V)
- High input-output isolation voltage ($V_{iso} = 5000$ Vrms)
- Current Transfer Ratio (CTR: min. 40% at $I_F = 10$ mA, $V_{CE} = 5$ V)
- Response time (t_r : typ., 5 μ s at $V_{CC} = 10$ V, $I_C = 2$ mA, $R_L = 100$ Ω)
- Dual-in-line package
- UL approved
- CSA approved
- IEC/EN/DIN EN 60747-5-2 approved
- Options available:
 - Leads with 0.4" (10.16 mm) spacing (W00)
 - Leads bend for surface mounting (300)
 - Tape and reel for SMD (500)
 - IEC/EN/DIN EN 60747-5-2 approvals (060)

Schematic



CAUTION: It is advised that normal static precautions be taken in handling and assembly of this component to prevent damage and/or degradation which may be induced by ESD.

Ordering Information

CNY17-x is UL Recognized with 5000 Vrms for 1 minute per UL1577 and is approved under CSA Component Acceptance Notice #5, File CA 88324.

Part Number	RoHS Compliant Option				Package	Surface Mount	Gull Wing	Tape & Reel	IEC/EN/DIN EN60747-5-2	Quantity
	-1	-2	-3	-4						
	40% <CTR< 80%	63% <CTR< 125%	100% <CTR< 200%	160% <CTR< 320%						
CNY17	-000E	-000E	-000E	-000E	300 mil DIP-6					65 pcs per tube
	-300E	-300E	-300E	-300E	300 mil DIP-6	X	X			65 pcs per tube
	-500E	-500E	-500E	-500E	300 mil DIP-6	X	X	X		1000 pcs per reel
	-060E	-060E	-060E	-060E	300 mil DIP-6				X	65 pcs per tube
	-360E	-360E	-360E	-360E	300 mil DIP-6	X	X		X	65 pcs per tube
	-560E	-560E	-560E	-560E	300 mil DIP-6	X	X	X	X	1000 pcs per reel
	-W00E	-W00E	-W00E	-W00E	400 mil DIP-6					65 pcs per tube
	-W60E	-W60E	-W60E	-W60E	400 mil DIP-6				X	65 pcs per tube

To order, choose a part number from the part number column and combine with the desired option from the option column to form an order entry.

Example 1:

CNY17-1-360E to order product of 300 mil DIP-6 DC Gull Wing Surface Mount package in Tube packaging with 40%<CTR<80%, IEC/EN/DIN EN 60767-5-2 Safety Approval and RoHS compliant.

Example 2:

CNY17-2-W00E to order product of 400 mil DIP-6 DC in Tube packaging with 63%<CTR<125% and RoHS compliant.

Option datasheets are available. Contact your Avago sales representative or authorized distributor for information.

Package Outline Drawings
CNY17-X-000E

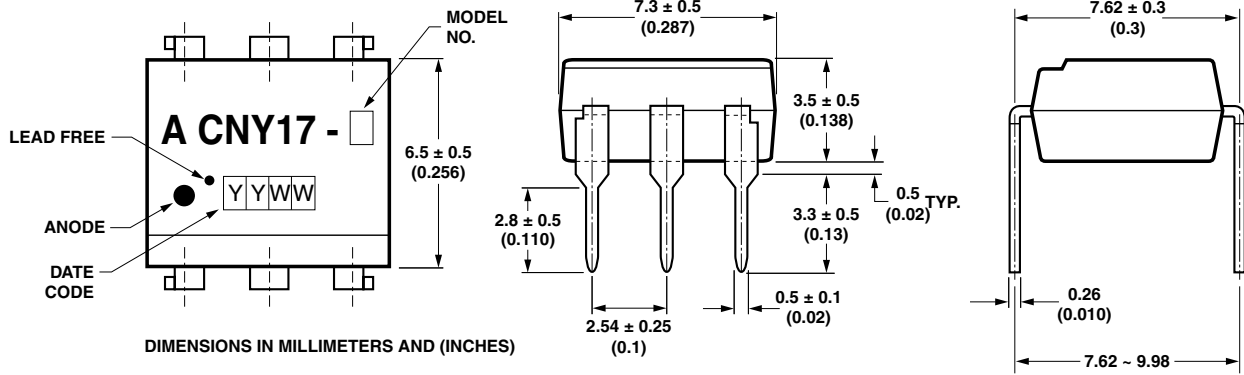

CNY17-X-060E

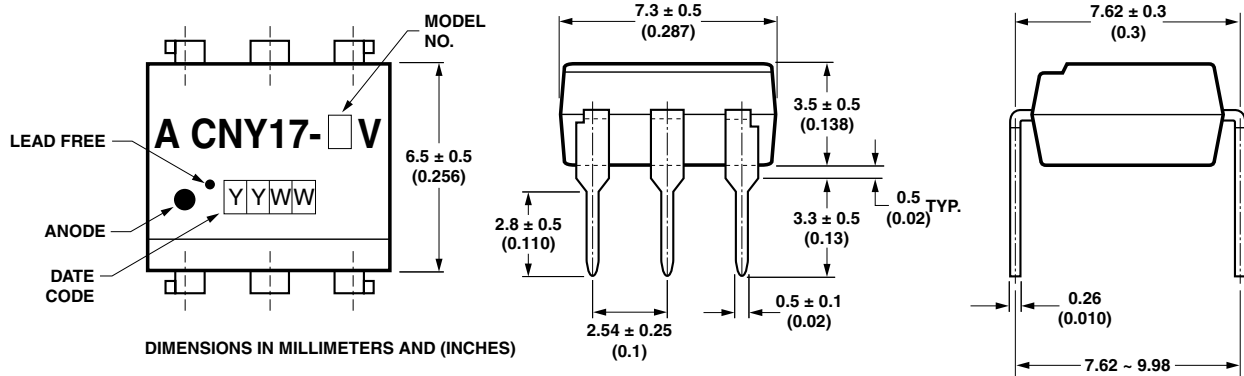

CNY17-X-W00E



CNY17-X-300E

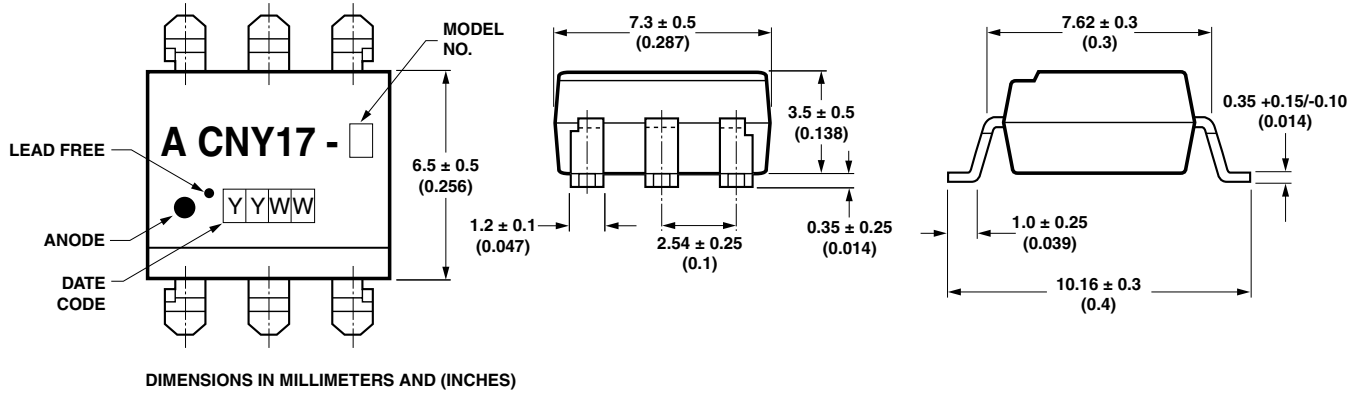

Solder Reflow Temperature Profile

- 1) One-time soldering reflow is recommended within the condition of temperature and time profile shown at right.
- 2) When using another soldering method such as infrared ray lamp, the temperature may rise partially in the mold of the device. Keep the temperature on the package of the device within the condition of (1) above.

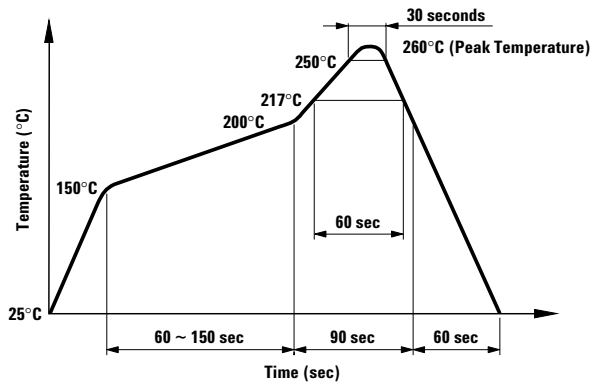

Note: Non-halide flux should be used.

Absolute Maximum Ratings

Storage Temperature, T_S	-55°C to +150°C
Operating Temperature, T_A	-55°C to +100°C
Lead Solder Temperature, max. (1.6 mm below seating plane)	260°C for 10 s
Average Forward Current, I_F	60 mA
Reverse Input Voltage, V_R	6 V
Input Power Dissipation, P_I	100 mW
Collector Current, I_C	150 mA
Collector-Emitter Voltage, V_{CE0}	70 V
Emitter-Collector Voltage, V_{EC0}	6 V
Collector-Base Voltage, V_{CB0}	70 V
Collector Power Dissipation	150 mW
Total Power Dissipation	250 mW
Isolation Voltage, V_{ISO} (AC for 1 minute, R.H. = 40 ~ 60%)	5000 Vrms

Electrical Specifications (T_A = 25°C)

Parameter	Symbol	Min.	Typ.	Max.	Units	Test Conditions
Forward Voltage	V _F	–	1.4	1.7	V	I _F = 60 mA
Reverse Current	I _R	–	–	10	μA	V _R = 6 V
Terminal Capacitance	C _t	–	–	100	pF	V = 0, f = 1 MHz
Collector Dark Current	I _{CEO}	–	–	50	nA	V _{CE} = 10 V
Collector-Emitter Breakdown Voltage	BV _{CEO}	70	–	–	V	I _C = 0.1 mA, I _F = 0
Emitter-Collector Breakdown Voltage	BV _{ECO}	6	–	–	V	I _E = 10 μA, I _F = 0
Collector-Base Breakdown Voltage	BV _{CBO}	70	–	–	V	I _C = 0.1 mA, I _F = 0
Collector Current	I _C	4	–	32	mA	I _F = 10 mA
*Current Transfer Ratio	CNY17-1 CNY17-2 CNY17-3 CNY17-4	CTR	40 63 100 160	– – – –	80 125 200 320	% V _{CE} = 5 V
Collector-Emitter Saturation Voltage	V _{CE(sat)}	–	–	0.3	V	I _F = 10 mA, I _C = 2.5 mA
Response Time (Rise)	t _r	–	5	10	μs	V _{CE} = 5 V, I _C = 10 mA
Response Time (Fall)	t _f	–	5	10	μs	R _L = 100 Ω
Isolation Resistance	R _{iso}	1 x 10 ¹¹	–	–	Ω	DC 500 V 40 ~ 60% R.H.
Floating Capacitance	C _f	–	–	2	pF	V = 0, f = 1 MHz

$$* CTR = \frac{I_C}{I_F} \times 100\%$$



Figure 1. Forward current vs. temperature.

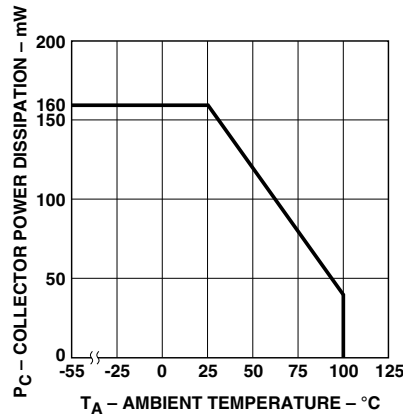

Figure 2. Collector power dissipation vs. temperature.

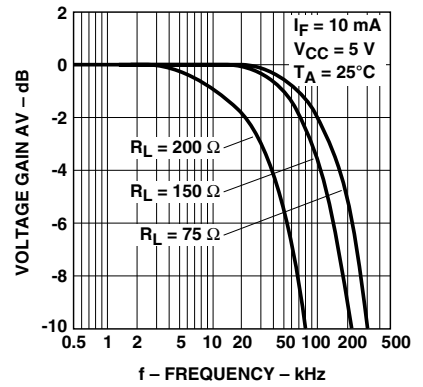

Figure 3. Frequency response.

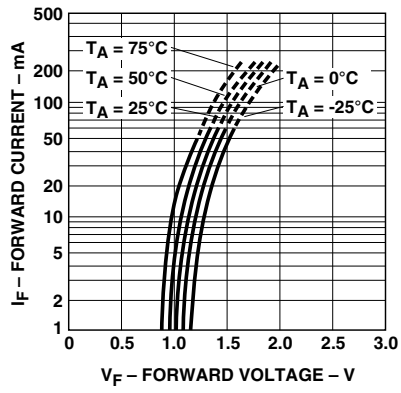

Figure 4. Forward current vs. forward voltage.

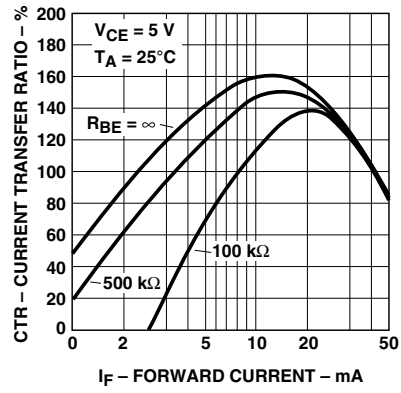

Figure 5. Current transfer ratio vs. forward current.

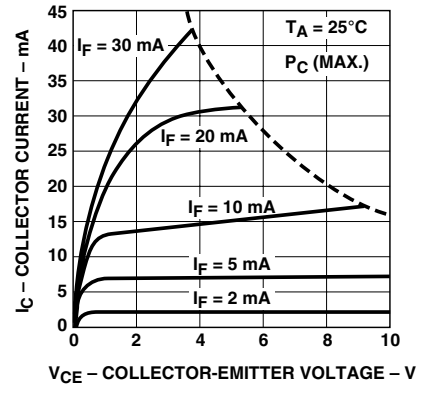

Figure 6. Collector current vs. collector-emitter voltage.

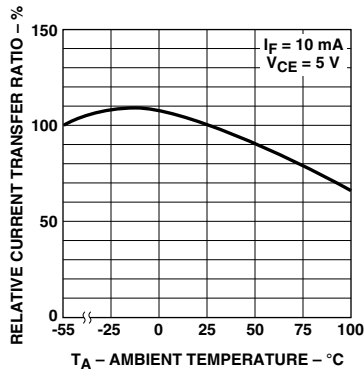

Figure 7. Relative current transfer ratio vs. temperature.

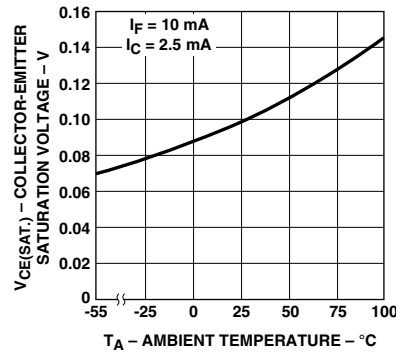

Figure 8. Collector-emitter saturation voltage vs. temperature.

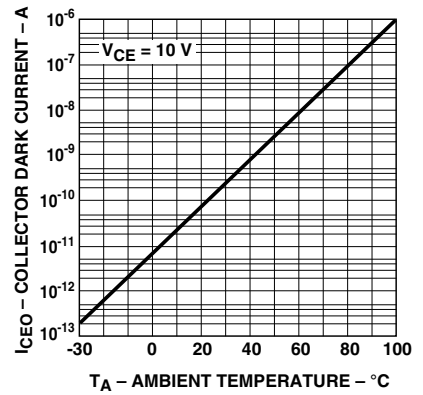

Figure 9. Collector dark current vs. temperature.

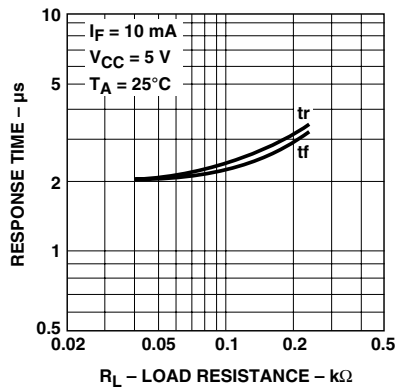

Figure 10. Response time vs. load resistance.

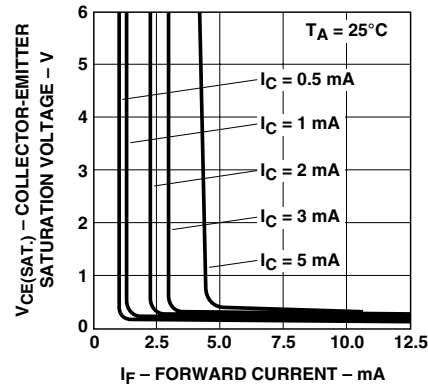
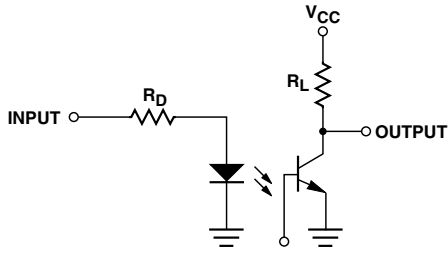
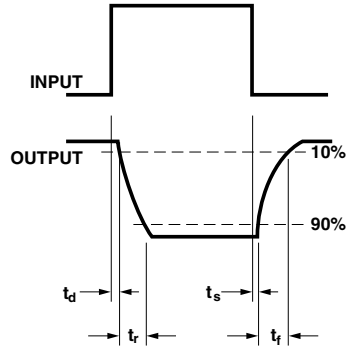
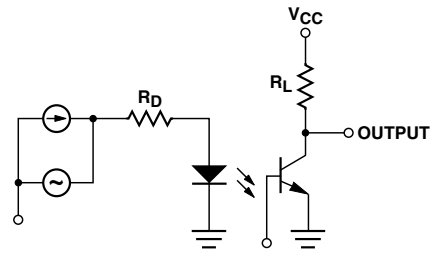

Figure 11. Collector-emitter saturation voltage vs. forward current.

Test Circuit for Response Time



Test Circuit for Frequency Response



For product information and a complete list of distributors, please go to our website: www.avagotech.com

Avago, Avago Technologies, and the A logo are trademarks of Avago Technologies Limited in the United States and other countries. Data subject to change. Copyright © 2007 Avago Technologies Limited. All rights reserved. Obsoletes AV01-0536EN AV02-0772EN - October 18, 2007

