

KB357NT

Features

1. Opaque type, mini-flat package.
2. Subminiature type (The volume is smaller than that of our conventional DIP type by as far as 30%).
3. Isolation voltage between input and output V_{iso} : 3750Vrms.
4. Employs double transfer mold technology.
5. Recognized by UL and CUL, file NO. E225308.
6. Package: 1000Pcs / Reel.
7. LEAD AND CADMIUM FREE.

Applications

1. Hybrid substrates that require high density mounting.
2. Programmable controllers.

*PACKAGE DIMENSIONS (UNIT:mm) SMD Type

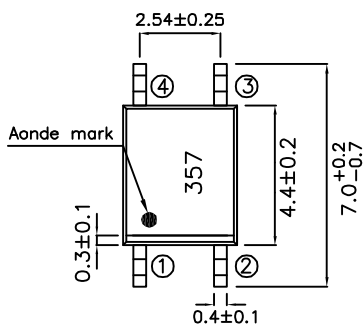

Internal connection diagram

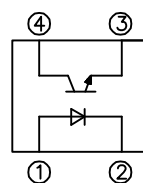

- | | |
|-----------|-------------|
| ① Anode | ③ Emitter |
| ② Cathode | ④ Collector |

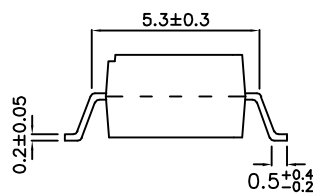
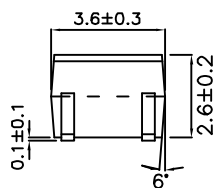

UNIT : MM[INCH]
TOLERANCE : $\pm 0.5[\pm 0.02]$ UNLESS OTHERWISE NOTED.

KB357NT

*Absolute Maximum Ratings (Ta=25°C)

Parameter		Symbol	Rating	Unit
Input	Forward current	IF	50	mA
	Reverse Voltage	VR	6	V
	Power dissipation	P	70	mW
Output	Collector-emitter voltage	VCEO	35	V
	Emitter-collector voltage	VECO	6	V
	Collector current	IC	50	mA
	Collector power dissipation	Pc	150	mW
Total power dissipation		P tot	170	mW
*1 Isolation voltage		V iso	3750	Vrms
Operating temperature		T opr	-30 to +100	°C
Storage temperature		T stg	-40 to +125	°C
*2 Soldering temperature		T sol	260	°C

*1 40 to 60%RH, AC for 1 minute.

*2 For 10 seconds.

*Electro-optical Characteristics

Parameter		Symbol	Conditions	Min.	Typ.	Max.	Unit	
Input	Forward voltage	VF	IF=20mA	-	1.2	1.4	V	
	Peak forward voltage	VFM	IFM=0.5A	-	-	3.0	V	
	Reverse Current	IR	VR=4V	-	-	10	uA	
Output	Collector dark current	ICEO	Vce=20V IF=0	-	-	10 ⁻⁷	A	
Transfer characteristics	Current transfer ratio		CTR	IF=5mA Vce=5V	50	-	600	%
	Collector-emitter saturation voltage		VCE (sat)	IF=20mA Ic=1mA	-	-	0.2	V
	Response time	Rise time	tr	Vce=2V Ic=2mA RL=100Ω	-	4	18	uS
		Fall time	tr		-	3	18	uS

Model No.	Rank mark	CTR(%)
KB357NLT	L	50 to 100
KB357N1T	A	80 to 160
KB357N2T	B	130 to 260
KB357N3T	C	200 to 400
KB357N4T	D	300 to 600
KB357N5T	A or B	80 to 260
KB357N6T	B or C	130 to 400
KB357N7T	C or D	200 to 600
KB357N8T	A,B or C	80 to 400
KB357N9T	B,C or D	130 to 600
KB357N0T	A,B,C or D	80 to 600
KB357NT	L,A,B,C,D or No mark	50 to 600

Fig. 1 Current Transfer Ratio vs. Forward Current

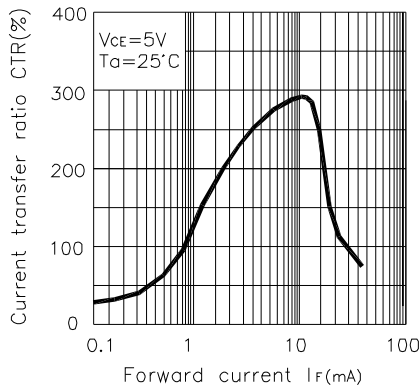

Fig. 2 Forward Current vs. Forward voltage

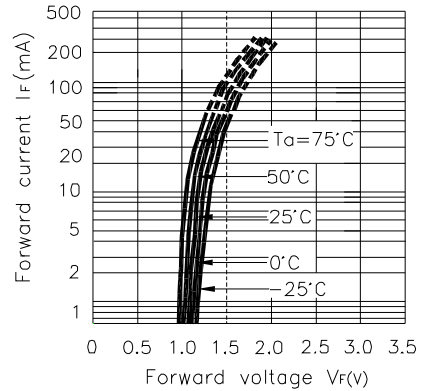

Fig. 3 Collector Current vs. Collector-emitter Voltage

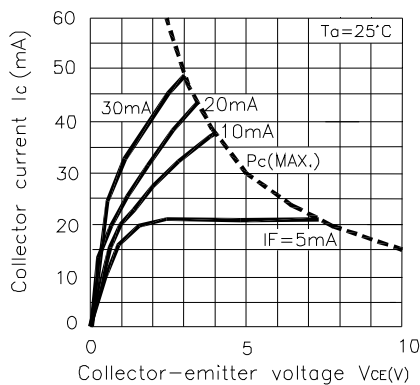

Fig. 4 Relative Current Transfer Ratio vs. Ambient Temperature

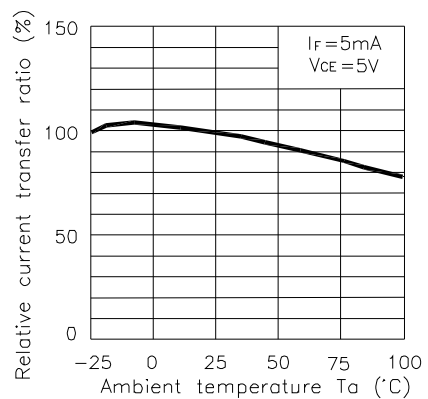

Fig. 5 Collector-emitter Saturation Voltage vs. Ambient Temperature

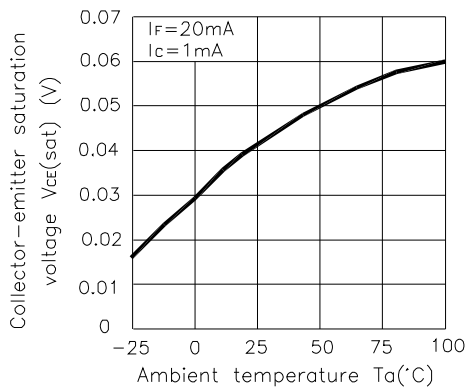

Fig. 6 Response Time vs. Load Resistance

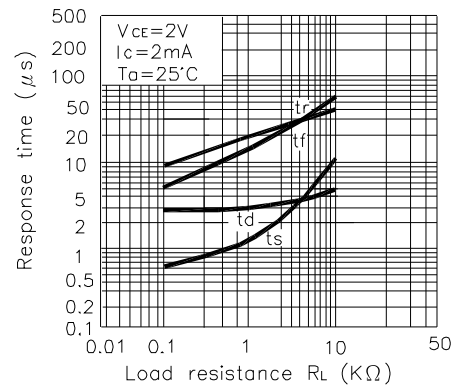

Fig. 7 Collector-emitter Saturation Voltage vs. Forward Current

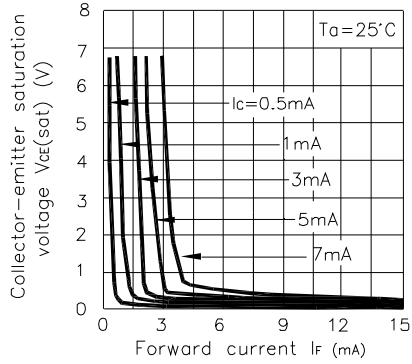
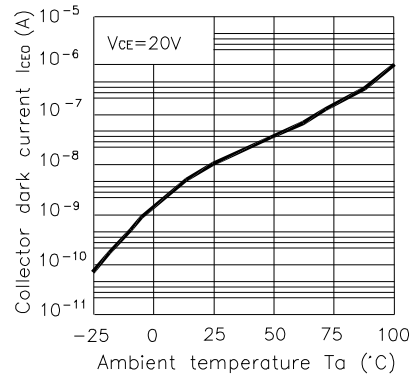
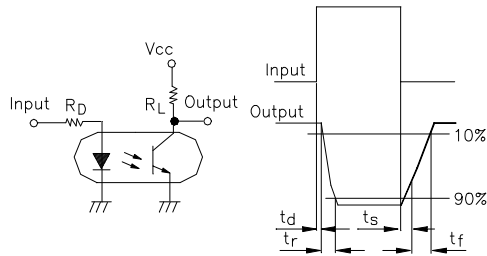

Fig. 8 Collector Dark Current vs. Ambient Temperature



Test Circuit for Response Time



* NOTES ON HANDLING

1.Recommended soldering conditions (Dip soldering)

(1) Dip soldering

Temperature	260 or below (molten solder temperature)
Time	Less than 10 seconds.
Cycle	One cycle allowed to be dipped in solder including plastic mold portion.
Flux	Rosin flux containing small amount of chlorine (The flux with a maximum chlorine content of 0.2 Wt % is recommended.)

(2) Cautions

Fluxes

Avoid removing the residual flux with freon-based and chlorine-based cleaning solvent.

2.Cautions regarding noise

Be aware that power is suddenly into the component any surge current may cause damage happen, even if the voltage is within the absolute maximum ratings.

NOTES ON HANDLING

1.Recommended soldering conditions

(1).Infrared reflow soldering

- Peak reflow temperature 235 ° C or below(package surface temperature)
- Time of temperature higher than 210 ° C 30 seconds or less
- Number of reflows Three
- Flux Rosin flux containing small amount of chlorine(The flux with a maximum chlorine content of 0.2Wt % is recommended.)

Recommended Temperature Profile of infrared Reflow

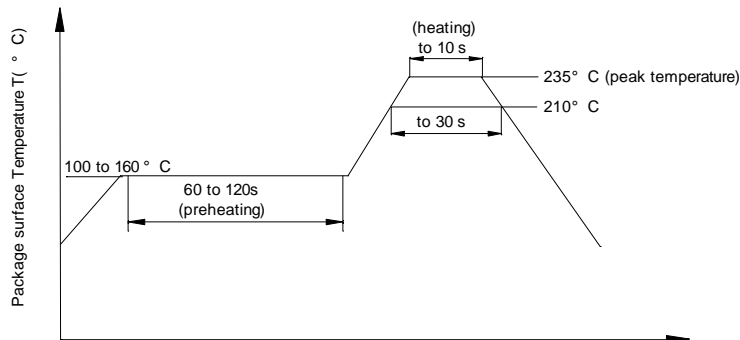

CAUTION

Within this device there exists GaAs (Gallium Arsenide) material which is a harmful substance if ingested. GaAs dust and fumes are toxic. Do not break, cut or pulverize the product, or use chemicals to dissolve them.

RESTRICTIONS ON PRODUCT USE

- The information in this document is subject to change without notice. Before using this document, please confirm that this is the latest version. Not all devices / types available in every country.
- We are mention about our product quality stability, semiconductor devices in general can malfunction or fail due to their inherent electrical sensitivity and vulnerability to physical stress. It is the responsibility of the buyer, when utilizing KINGBRIGHT products, to observe standards of safety, and to a avoid situations in which a malfunction or failure of a KINGBRIGHT product could cause loss of human life, bodily injury or damage to property. In developing your designs, please ensure that KINGBRIGHT products are used within specified operating ranges as set forth in the most recent products specifications.

KB357NT

Outline and Dimension(Tape) (Units : mm)

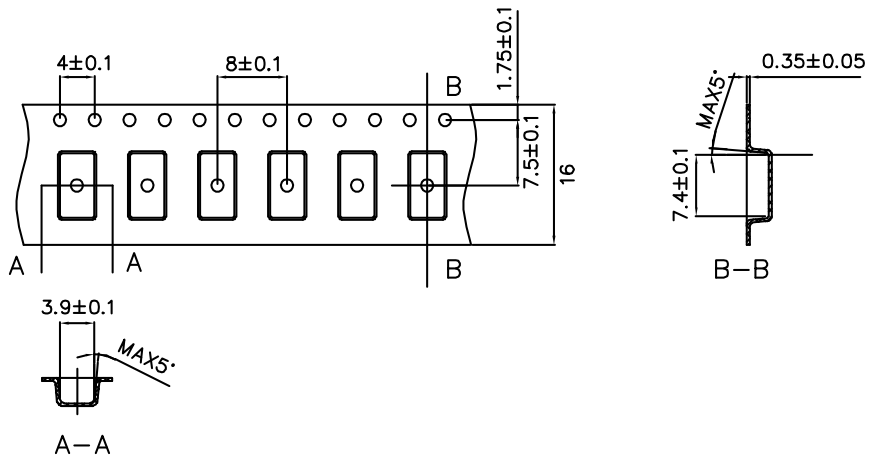

Tape Direction

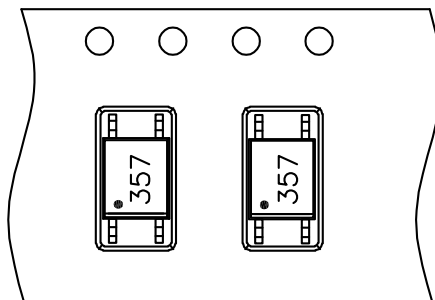

Outline and Dimension(Reel)

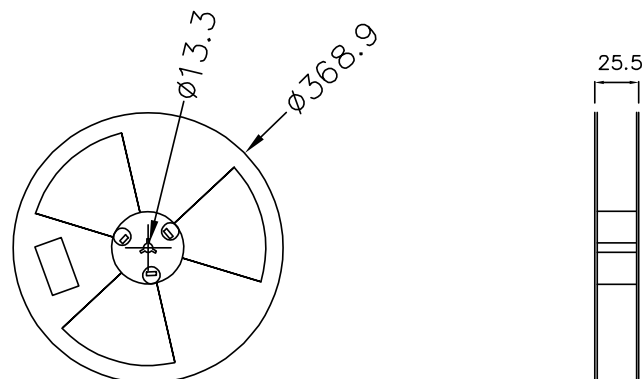

Packing: 1000pcs/reel