

ABSOLUTE MAXIMUM RATINGS

Supply Voltage	27V
GTDR Current Continuous	0.5A
GTDR Output Energy(Per Cycle)	5 μ J
I _{AC} , R _{SET} , PK _{LIM} Input Current	20mA
V _{SENSE} , EN/SYNC, OVP Input Voltage	V _{MAX}
I _{SENSE} , M _{OUT} Input Current	\pm 5mA
Operating Junction Temperature Range	
LT1248C	0°C to 100°C
LT1248I	-40°C to 125°C
Thermal Resistance (Junction-to-Ambient)	
N Package	100°C/W
S Package	120°C/W
Storage Temperature Range	-65°C to 150°C
Lead Temperature (Soldering, 10 sec)	300°C

PACKAGE/ORDER INFORMATION

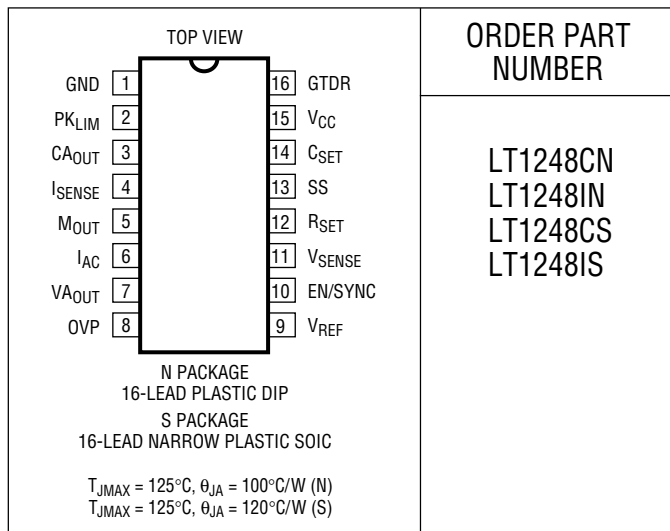

ORDER PART NUMBER

LT1248CN
LT1248IN
LT1248CS
LT1248IS

Consult factory for Military grade parts.

ELECTRICAL CHARACTERISTICS

Maximum operating voltage (V_{MAX}) = 25V, V_{CC} = 18V, R_{SET} = 15k to GND, C_{SET} = 1nF to GND, I_{AC} = 100 μ A, I_{SENSE} = 0V, CA_{OUT} = 3.5V, VA_{OUT} = 5V, OVP = 7.5V, no load on any outputs, unless otherwise noted.

PARAMETER	CONDITIONS	MIN	TYP	MAX	UNITS	
Overall						
Supply Current (V _{CC} in Undervoltage Lockout)	V _{CC} = Lockout Voltage - 0.2V	●	0.25	0.45	mA	
Supply Current (Inactive)	EN/SYNC = 0V, V _{CC} \leq V _{MAX}	●	0.5	1.5	mA	
Supply Current, On	11.5V \leq V _{CC} \leq V _{MAX}	●	8.5	12.0	mA	
V _{CC} Turn-On Threshold (Undervoltage Lockout)		●	15.5	16.5	17.5	V
V _{CC} Turn-Off Threshold		●	9.5	10.5	11.5	V
EN/SYNC Threshold, Rising		●	2.2	2.6	2.85	V
EN/SYNC Threshold Hysteresis			0.40		V	
EN/SYNC Input Current	EN/SYNC = 0V 3V \leq EN/SYNC \leq 7V	●	-5	-1	5	μ A
			-50	-25	50	μ A
Voltage Amplifier						
Voltage Amp Offset Voltage	VA _{OUT} = 3.5V	●	-8	8	mV	
Input Bias Current	V _{SENSE} = 0V to 7V	●	-25	-250	nA	
Voltage Gain			70	100	dB	
Voltage Amp Unity-Gain Bandwidth			3		MHz	
Voltage Amp Output High (Internally Clamped)		●	11.3	13.3	V	
Voltage Amp Output Low		●	1.1	2	V	
Voltage Amp Short-Circuit Current	VA _{OUT} = 0V	●	5	14	30	mA
SS Current	SS = 2.5V	●	5	12	30	μ A
Current Amplifier						
Current Amp Offset Voltage		●	\pm 1	\pm 4	mV	
I _{SENSE} Bias Current		●	-25	-250	nA	
Current Amp Voltage Gain			80	110	dB	
Current Amp Unity-Gain Bandwidth			3		MHz	
Current Amp Output High		●	7.2	8.5	V	
Current Amp Output Low		●	1.1	2	V	

ELECTRICAL CHARACTERISTICS

Maximum operating voltage (V_{MAX}) = 25V, V_{CC} = 18V, R_{SET} = 15k to GND, C_{SET} = 1nF to GND, I_{AC} = 100 μ A, I_{SENSE} = 0V, CA_{OUT} = 3.5V, VA_{OUT} = 5V, OVP = 7.5V. No load on any outputs, unless otherwise noted.

PARAMETER	CONDITIONS		MIN	TYP	MAX	UNITS
Current Amplifier						
Current Amp Short-Circuit Current	$CA_{OUT} = 0V$	●	5	14	30	mA
Input Range, I_{SENSE} , M_{OUT} (Linear Operation)		●	-0.3		1	V
Reference						
Reference Output Voltage	$I_{REF} = 0mA$, $T_A = 25^\circ C$		7.39	7.50	7.60	V
V_{REF} Load Regulation	$-5mA < I_{REF} < 0mA$			5		mV
V_{REF} Line Regulation	$11.5V < V_{CC} < V_{MAX}$	●	-20	5	20	mV
V_{REF} Short-Circuit Current	$V_{REF} = 0V$	●	12	28	50	mA
V_{REF} Worst Case	Load, Line, Temperature	●	7.32	7.5	7.68	V
Current Limit						
PK_{LIM} Offset Voltage		●	-15		15	mV
PK_{LIM} Input Current	$PK_{LIM} = -0.1V$	●		-50	-100	μ A
PK_{LIM} to GTDR Propagation Delay	PK_{LIM} Falling from 50mV to -50mV			400		ns
Multiplier						
Multiplier Output Current	$I_{AC} = 100\mu A$, $R_{SET} = 15k$			35		μ A
Multiplier Output Current Offset	$R_{AC} = 1M$ from I_{AC} to GND	●		-0.05	-0.5	μ A
Multiplier Maximum Output Current	$I_{AC} = 450\mu A$, $R_{SET} = 15k$, $VA_{OUT} = 7V$, $M_{OUT} = 0V$	●	-286	-260	-235	μ A
Multiplier Gain Constant (Note 1)				0.035		V^{-2}
I_{AC} Input Resistance	I_{AC} from 50 μ A to 1mA		15	25	35	k Ω
Oscillator						
Oscillator Frequency	$R_{SET} = 15k$, $C_{SET} = 1000pF$	●	85	100	115	kHz
	$R_{SET} = 15k$, $C_{SET} = 1500pF$	●	58	68	78	kHz
C_{SET} Ramp Peak-to-Peak Amplitude			4.35	4.7	5.0	V
C_{SET} Ramp Valley Voltage			1.25	1.4	1.55	V
Synchronization Pulse Threshold on EN/SYNC Pin	Pulse Low = 3.5V, High = 7V, Width > 200ns		4.5	5.6	6.5	V
Synchronization Frequency Range	$R_{SET} = 15k$, $C_{SET} = 1000pF$	●	1.2		1.6	f_{NOM}
Overvoltage Comparator						
Comparator Trip Voltage Ratio (V_{TRIP}/V_{REF})		●	1.04	1.05	1.06	
Hysteresis				0.35		V
OVP Bias Current	$OVP = 7.5V$	●		-50	-250	nA
OVP Propagation Delay				100		ns
Gate Driver						
Max GTDR Output Voltage	0mA Load, $18V < V_{CC}$	●	12	15	17.5	V
GTDR Output High	-200mA Load, $11.5V \leq V_{CC} \leq 15V$	●	$V_{CC} - 3.0$			V
GTDR Output Low (Device Unpowered)	$V_{CC} = 0V$, 50mA Load (Sinking)	●		0.9	1.5	V
GTDR Output Low (Device Active)	200mA Load (Sinking)	●		0.5	1	V
	10mA Load	●		0.2	0.4	V
Peak GTDR Current	10nF from GTDR to GND			2		A
GTDR Rise and Fall Time	1nF from GTDR to GND			25		ns
GTDR Max Duty Cycle			90	96		%

The ● denotes specifications which apply over the full operating temperature range.

Note 1: Multiplier Gain Constant: $K = \frac{I_M}{I_{AC}(VA_{OUT} - 2)^2}$

TYPICAL PERFORMANCE CHARACTERISTICS

Voltage Amplifier Open-Loop Gain and Phase

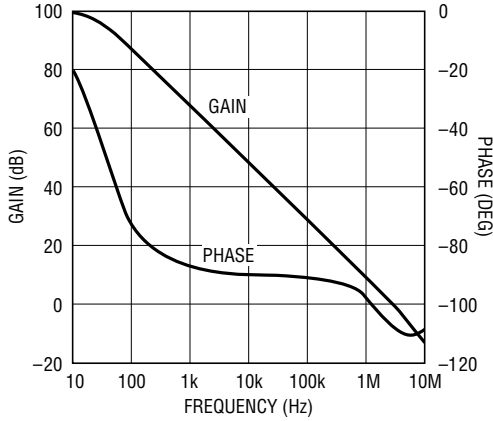

1148 G01

Current Amplifier Open-Loop Gain and Phase

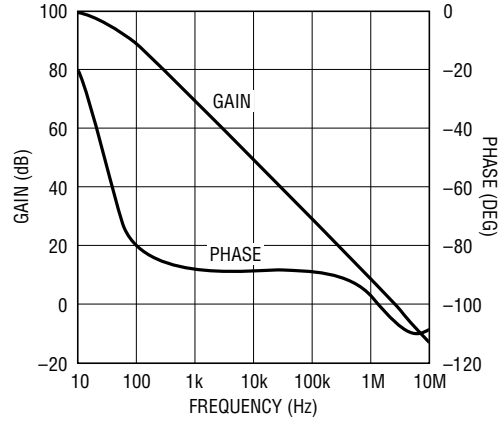

1148 G02

Reference Voltage vs Temperature

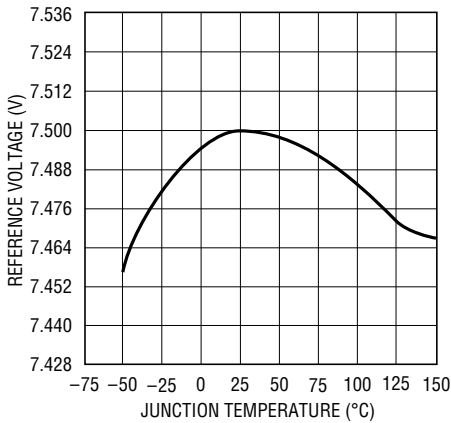

1248 G03

Multiplier Current

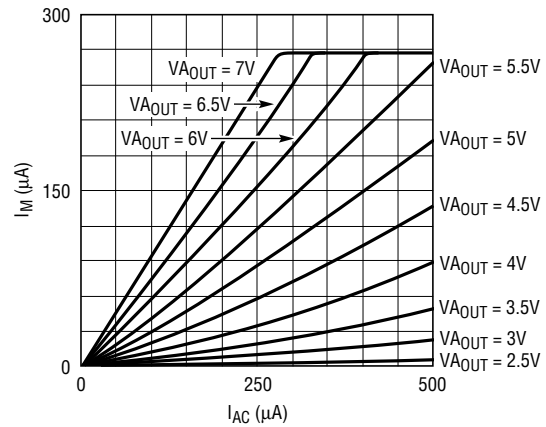

1248 G04

Supply Current vs Supply Voltage

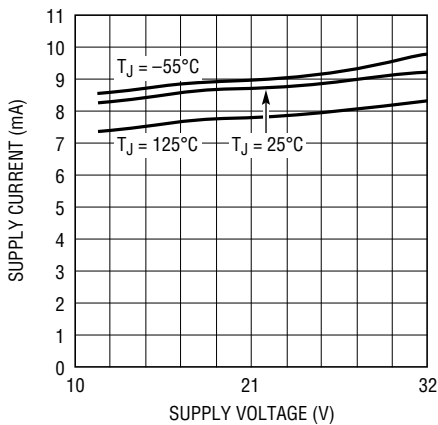

1248 G05

GTDR Source Current

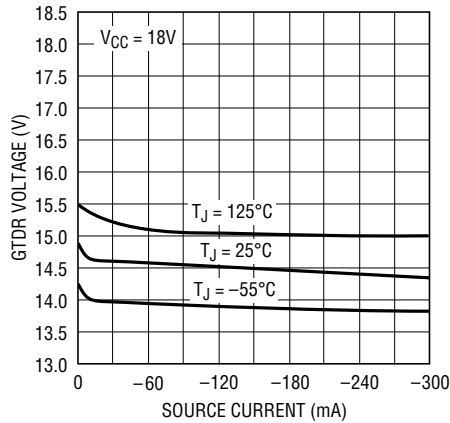

1248 G06

GTDR Sink Current

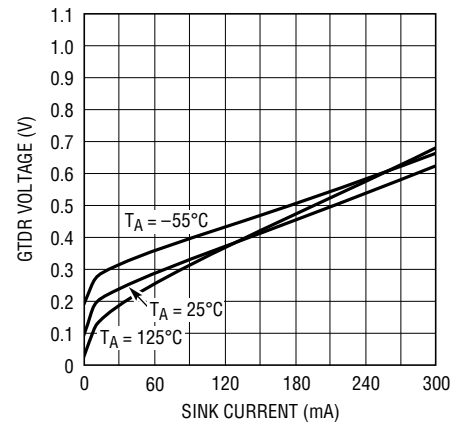

1248 G07

TYPICAL PERFORMANCE CHARACTERISTICS

GTDR Rise and Fall Time

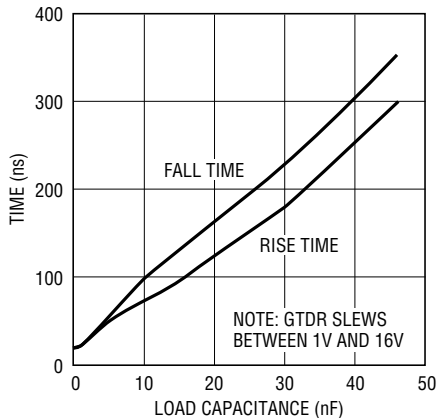

1248 G08

Startup Supply Current vs Supply Voltage

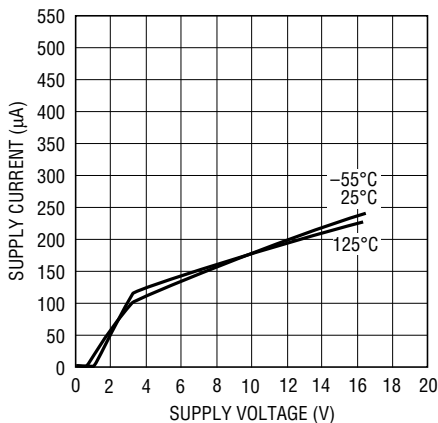

1248 G09

Frequency vs R_{SET} and C_{SET}

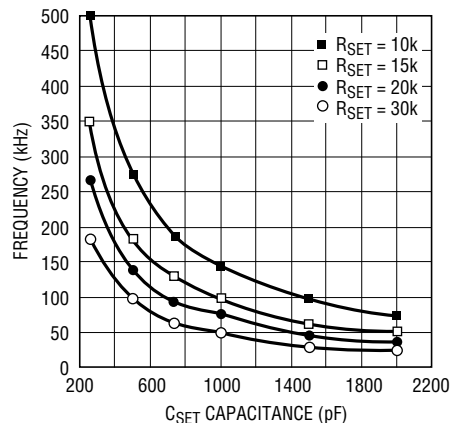

1248 G10

GTDR Maximum Duty Cycle vs R_{SET} and C_{SET}

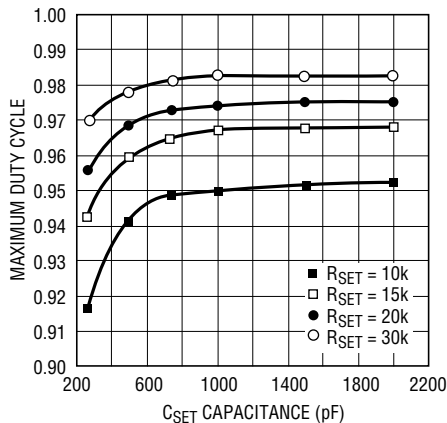

1248 G11

Shutdown Mode Supply Current and Reference Voltage

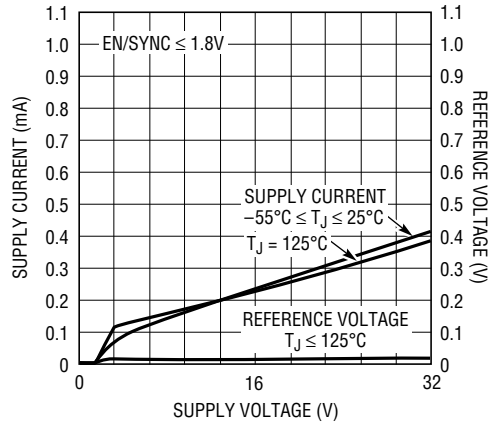

1248 G12

Synchronization and Shutdown Thresholds at EN/SYNC Pin

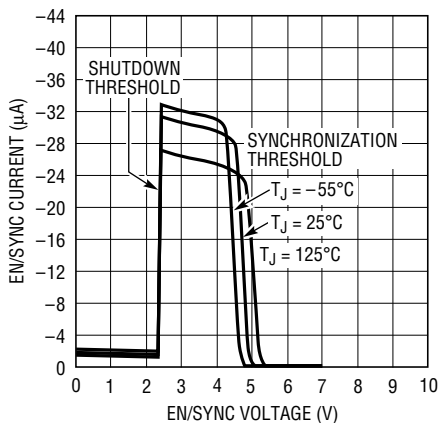

1248 G13

SS Pin Characteristics

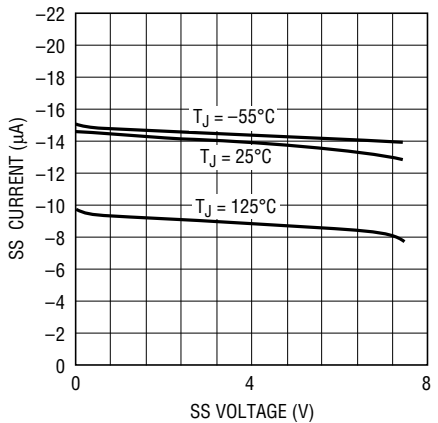

1248 G14

M_{OUT} Pin Characteristics

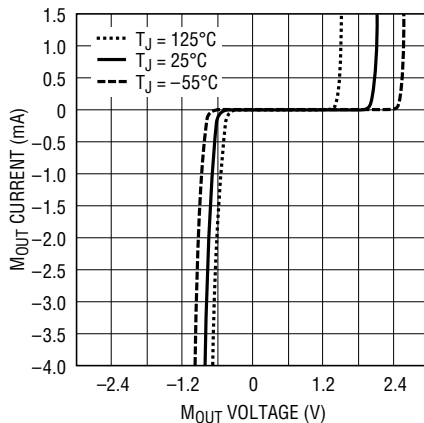

1248 G15

TYPICAL PERFORMANCE CHARACTERISTICS

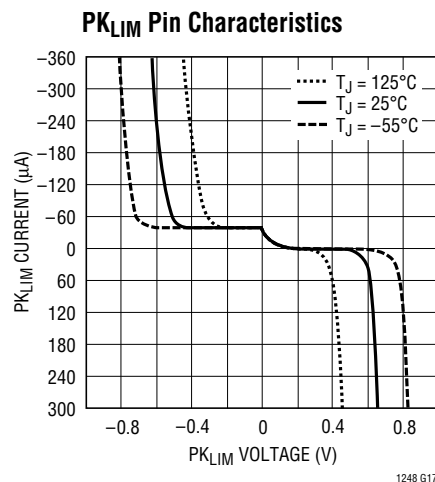
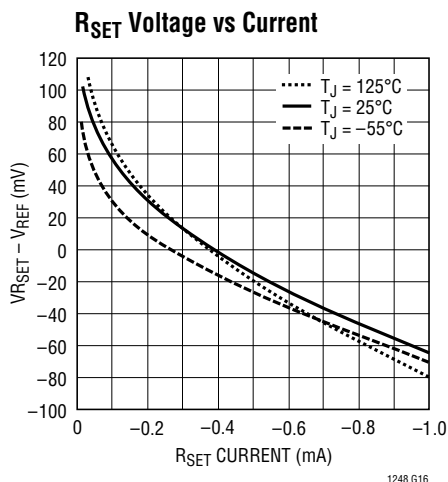

PIN FUNCTIONS

Pin 1 (GND).

Pin 2 (PK_{LIM}): The threshold of the peak current limit comparator is GND. To set current limit, a resistor divider can be connected from V_{REF} to current sense resistor.

Pin 3 (CA_{OUT}): This is the output of the current amplifier that senses and forces the line current to follow the reference signal that comes from the multiplier by commanding the pulse width modulator. When CA_{OUT} is low, the modulator has zero duty cycle.

Pin 4 (I_{SENSE}): This is the inverting input of the current amplifier. This pin is clamped at -0.6V by an ESD protection diode.

Pin 5 (M_{OUT}): This is the multiplier high impedance current output and the noninverting input of the current amplifier. This pin is clamped at -0.6V and 2V .

Pin 6 (I_{AC}): This is the AC line voltage sensing input to the multiplier. It is a current input that is biased at 2V to minimize the crossover dead zone caused by low line voltage. At the pin, a 25k resistor is in series with the current input, so that a lowpass RC can be used to filter out the switching noise from the high impedance lines.

Pin 7 (VA_{OUT}): This is the output of the voltage error amplifier. The output is clamped at 13.5V . When the output goes below 2.5V , the multiplier output current is zero.

Pin 8 (OVP): This is the input to the overvoltage comparator. The threshold is 1.05 times the reference voltage. When the comparator trips, the multiplier is quickly inhibited and outputs no current. Figure 4 in the Applications Information section shows how to set overvoltage threshold with only one additional resistor.

Pin 9 (V_{REF}): This is the 7.5V reference. When either V_{CC} or EN/SYNC goes low, V_{REF} will stay at 0V . V_{REF} biases most of the internal circuitry and can source up to 5mA externally.

Pin 10 (EN/SYNC): This pin has two functions. When it goes below 2.6V , the chip goes into shutdown mode and draws little current. Pulses at this pin that go below the 5V threshold will synchronize the chip. The synchronizing pulses should have an on-time of at least 200ns for the LT1248 resetting circuit to work.

Pin 11 (V_{SENSE}): This is the inverting input to the voltage amplifier.

PIN FUNCTIONS

Pin 12 (R_{SET}): A resistor from R_{SET} to GND sets the oscillator charging current and the maximum multiplier output current which is used to limit the maximum line current.

$$I_{M(\text{MAX})} = 3.75\text{V}/R_{\text{SET}}$$

Pin 13 (SS): Soft start. When either V_{CC} or EN/SYNC goes low, the SS pin will stay at 0V. With a capacitor from the pin to GND, the 12μA charging current slowly brings up the SS to 8V; below 7.5V SS is the reference input to the voltage amplifier. At supply dropout or EN/SYNC low, the soft start capacitor will be quickly discharged.

Pin 14 (C_{SET}): The capacitor from this pin to GND, and R_{SET}, determine oscillator frequency. The oscillator ramp is 5V, and the frequency = 1.5/(R_{SET} × C_{SET}).

Pin 15 (V_{CC}): This is the supply for the chip. The LT1248 has a very fast gate driver required to fast charge high power MOSFET gate capacitance. High current spikes occur during charging. For good supply bypass, a 0.1μF ceramic capacitor in parallel with a low ESR electrolytic capacitor, 56μF or higher is required in close proximity to IC GND.

Pin 16 (GTDR): The MOSFET gate driver is a 1.5A fast totem pole output. It is clamped at 15V, but capacitive loads like MOSFET gates may cause overshoot. A gate series resistor of at least 5Ω will prevent the overshoot.

APPLICATIONS INFORMATION

Error Amplifier

The error amplifier has a 100dB DC gain and 3MHz unity-gain frequency. The output is internally clamped at 13.5V. The noninverting input is tied to the 7.5V V_{REF} through a diode and can be pulled down from the SS (soft start) pin.

Current Amplifier

The current amplifier has a 110dB DC gain, 3MHz unity-gain frequency, and a 2V/μs slew rate. It is internally clamped at 8.5V. Note that in the current averaging operation, high gain at twice the line frequency is necessary to minimize line current distortion. Because C_{AOUT} may need to swing 5V over one line cycle at high line condition, 14mV AC will be needed at the inputs of the current amplifier for a gain of 350 at 120Hz. Especially at light load when the current loop reference signal is small, lower gain will distort the reference signal and line current. If signal gain at switching frequency is too high, the system behaves more like a current mode system and can cause subharmonic oscillation. Therefore, the current amplifier should be compensated to have a gain of less than 15 at the switching frequency, but more than 250 at twice the line frequency.

Multiplier

The multiplier is a current multiplier with high noise immunity in a high power switching environment. The current gain is: $I_M = (I_{AC} \times I_{EA}^2) / (200\mu\text{A})^2$, with $I_{EA} = (V_{AOUT} - 2\text{V}) / 25\text{k}$. With a square function, because of the lower gain at light power load, system stability is maintained and line current distortion caused by the line frequency AC ripple

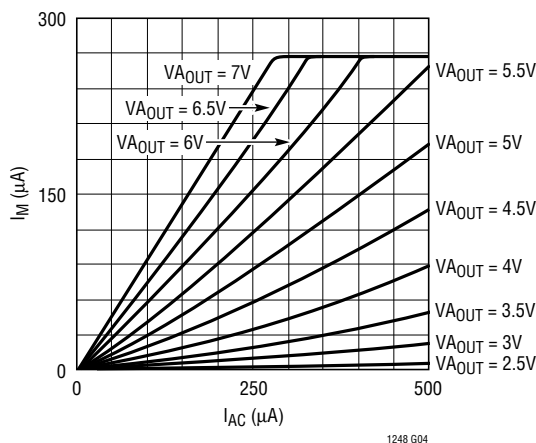

Figure 1. Multiplier Current I_M vs I_{AC} and V_{AOUT}

APPLICATIONS INFORMATION

fed back to the error amplifier is minimized. Note that switching ripple on the high impedance lines could get into the multiplier from the I_{AC} pin and cause instability. The LT1248 provides an internal 25k resistor in series with the low impedance multiplier current input so that only a capacitor from the I_{AC} pin to GND is needed to filter out the noise. The maximum multiplier output current, which limits the system line current, is set by the R_{SET} according to the formula: I_{M(MAX)} = 3.75V/R_{SET}.

Oscillator Frequency and Maximum Line Current Settling

Oscillator frequency is set by R_{SET} and C_{SET}. Ramp amplitude is 5V and C_{SET} charging current is set by V_{REF}/R_{SET}. Typical discharging time for C_{SET} = 1nF is 250ns. R_{SET} should always be determined first to set the maximum multiplier output current for system line current limit. For a 300W preregulator, with R_{SET} = 15k, I_{M(MAX)} = 3.75V/15k = 250μA. With a 4k resistor R_{REF} from M_{OUT} to the 0.2Ω line current sense resistor R_S, the line current limit is: (I_M × 4k)/R_S. As a general rule, R_S is chosen according to:

$$R_S = \frac{I_{M(MAX)} \times R_{REF} \times V_{LINE(MIN)}}{K(1.414)P_{OUT(MAX)}}$$

where P_{OUT(MAX)} is the maximum power output and K is usually between 1.1 and 1.3 depending on efficiency and resistor tolerance. With R_{SET} selected, C_{SET} can then be determined by: C_{SET} = 1.5/(Frequency × R_{SET}). For 100kHz, C_{SET} = 1.5/(100kHz × 15k) = 1nF. For optional double protection, the LT1248 provides a current limit comparator. When the comparator trips at 0V, the GTDR pin quickly goes low to shut off the MOS switch. A resistor divider from V_{REF} to R_S (Figure 2) senses the voltage across the line current sense resistor and the current limit is set by: I_{LINE} = [(7.5V/R1) + 50μA](R2/R_S), where 50μA is I_{PKLIM}.

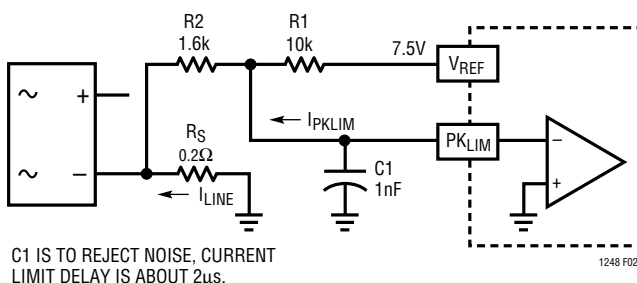

Figure 2.

With I_{LINE} and R_S chosen, let R1 = 10k, then R2 = (I_{LINE} × R_S)/0.8mA.

Always use R_{SET} to set the primary line current limit. The PK_{LIM} comparator is only for secondary protection. The secondary limit should be higher than the primary limit; 6.5A is good (5A for primary limit) for a 300W regulator. When line current reaches the primary limit, V_{OUT} drops to keep the line current constant, and system stability is still maintained by the current loop which is controlled by the current amplifier. When line current reaches the secondary limit, the comparator controls the system and loop hysteresis may occur and can cause audible noise.

Synchronization

The LT1248 can be synchronized to a frequency that is up to 1.6 times the natural frequency. With a 200ns one-shot timer on-chip, the LT1248 provides flexibility on the synchronizing pulse width. Because the EN/SYNC pin also serves the chip shutdown function, the pulses at the pin should not go below 3V and must go below 5V with widths greater than 200ns. The Figure 3 circuit will synchronize the LT1248.

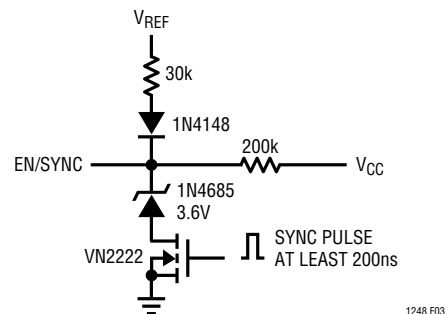

Figure 3.

Overvoltage Protection

Because of the slow loop response necessary for power factor correction, output overshoot can occur with sudden load removal or reduction. To protect the power components and output load, the LT1248 provides an overvoltage comparator which senses the output voltage and quickly shuts off the current switch. In Figure 4, because there is no DC current going through R3, R1 and R2 set the regulator output DC level: V_{OUT} = V_{REF}[(R1 + R2)/R2], with R1 = 1M, R2 = 20k, V_{OUT} is 382V.

APPLICATIONS INFORMATION

Note that V_{SENSE} is the summing node and it stays at 7.5V. When overshoot occurs on V_{OUT} , the overcurrent from R1 will go through R2 as well as R3. Amplifier feedback will keep V_{SENSE} locked at 7.5V. The equivalent AC resistance, seen by the comparator input pin OVP, is R2 in parallel with R3, which is 10k. Therefore, with the comparator trip level of $1.05V_{REF}$ and R3 of 20k, the comparator trips when V_{OUT} overshoot exceeds 10%. Overvoltage trip level:

$$\%V_{OUT} = 5\% \left(\frac{R2 + R3}{R3} \right)$$

M_{OUT} is a high impedance current output. In the current loop, offset line current is determined by multiplier offset current and input offset voltage of the current amplifier. A $-4mV$ current amplifier V_{OS} translates into 20mA line current and 5W input power for 250V line if 0.2Ω sense resistor is used. Under no load or when the load power is less than this offset input power, V_{OUT} would slowly charge up to an overvoltage state because the overvoltage comparator can only reduce multiplier output current to zero. This does not guarantee zero output current if the current amplifier has offset. To regulate V_{OUT} under this condition, the amplifier M1 (see Block Diagram), becomes active in the current loop when V_{AOUT} goes down to 2.2V. The M1 can put out up to $7\mu A$ to the resistor at the I_{SENSE} pin to cancel any current amplifier negative V_{OS} and keep V_{OUT} error to within 2V.

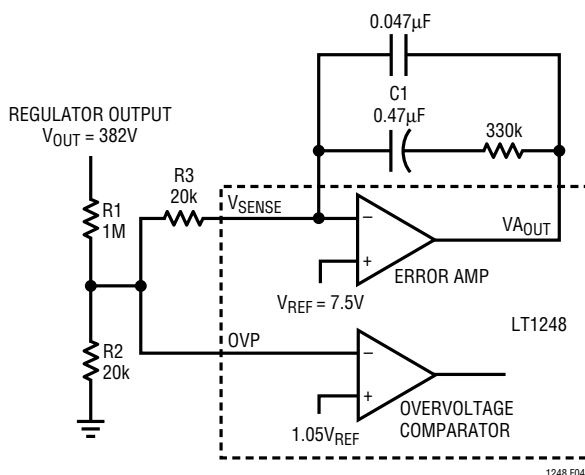

Figure 4.

Undervoltage Lockout

The LT1248 turns on when V_{CC} is higher than 16V and remains on until V_{CC} falls below 10V, whereupon the chip enters the lockout state. In the lockout state, the LT1248 only draws $250\mu A$, the oscillator is off, and the V_{REF} and the GTDR pins remain low to keep the power MOSFET off.

Start-Up and Supply Voltage

The LT1248 draws only $250\mu A$ before the chip starts at 16V on V_{CC} . To trickle start, a 90k resistor from the power line to V_{CC} supplies the trickle current and C4 holds the V_{CC} up while switching starts. Then the auxiliary winding takes over and supplies the operating current. Note that D3 and the large value C3, in both Figures 5 and 6, are only necessary for systems that have sudden large load variation down to minimum load and/or very light load conditions. Under these conditions, the loop may exhibit a start/restart mode because switching remains off long enough for C4 to discharge below 10V. The C3 will hold V_{CC} up until switching resumes. For less severe load variations, D3 is replaced with a short and C3 is omitted. The turns ratio between the primary winding and the auxiliary winding determines V_{CC} according to:

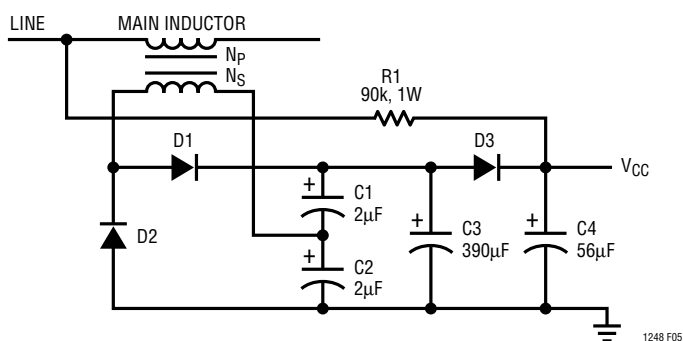

Figure 5.

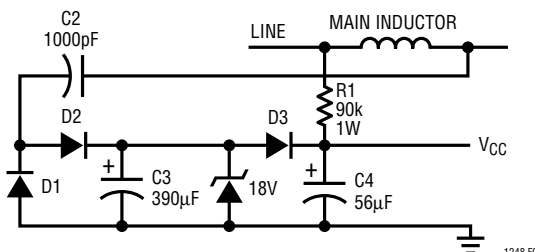

Figure 6.

APPLICATIONS INFORMATION

$$V_{OUT}/(V_{CC} - 2V) = N_p/N_s.$$

For 382V V_{OUT} and 18V V_{CC} , $N_p/N_s \approx 19$.

In Figure 6, a new technique for supply voltage eliminates the need for an extra inductor winding. It uses capacitor charge transfer to generate a constant current source which feeds a Zener diode. Current to the Zener is equal to $(V_{OUT} - V_Z)(C)(f)$, where V_Z is Zener voltage and f is switching frequency. For $V_{OUT} = 382V$, $V_Z = 18V$, $C = 1000pF$, and $f = 100kHz$, Zener current will be 36mA. This is enough to operate the LT1248, including the FET gate drive. Normally soft start is not needed because the LT1248 has overcurrent limit and overvoltage protection. If soft start is used with a $0.01\mu F$ capacitor on SS pin, V_{OUT} ramps up slower during startup. Then C4 has to hold V_{CC} longer, and the circuit may not start. Increasing C4 to $100\mu F$ ensures startup, but startup time will be extended if the same 90k trickle charge resistor is used.

Output Capacitor

The peak-to-peak 120Hz output ripple is determined by:

$$V_{P-P} = (2) (I_{LOAD(DC)})(Z)$$

where $I_{LOAD(DC)}$: DC load current.

Z: capacitor impedance at 120Hz.

For $180\mu F$ at 300W load, $I_{LOAD(DC)} = 300W/385V = 0.78A$, $V_{P-P} = 2 \times 0.78A \times 7.4\Omega = 11.5V$. If less ripple is desired, higher capacitance should be used. The selection of the output capacitor should also be based on the operating ripple current through the capacitor. The ripple current can be divided into three major components. The first is at 120Hz; it's RMS value is related to the DC load current as follows:

$$I_{1RMS} \approx 0.71 \times I_{LOAD(DC)}$$

The second component contains the PF switching frequency ripple current and its harmonics. Analysis of the ripple is complicated because it is modulated with a 120Hz signal. However computer numerical integration and Fourier analysis approximate the RMS value reasonably close to the bench measurements. The RMS value is about 0.82A at a typical condition of 120VAC, 200W load. This ripple is line-voltage dependent, and the worst case is at low line.

$$I_{2RMS} = 0.82A \text{ at } 120VAC, 200W$$

The third component is the switching ripple from the load, if the load is a switching regulator.

$$I_{3RMS} \approx I_{LOAD(DC)}$$

For the United Chemicon KMH 400V capacitor series, ripple current multiplier for currents at 100kHz is 1.43. The equivalent 120Hz ripple current can be then found:

$$I_{RMS} = \sqrt{(I_{1RMS})^2 + (I_{2RMS}/1.43)^2 + (I_{3RMS}/1.43)^2}$$

For a typical system that runs at an average load of 200W and 385V output:

$$I_{LOAD(DC)} = 0.52A$$

$$I_{1RMS} \approx 0.71 \times 0.52A = 0.37A$$

$$I_{2RMS} \approx 0.82A \text{ at } 120VAC$$

$$I_{3RMS} \approx I_{LOAD(DC)} = 0.52A$$

$$I_{RMS} = \sqrt{(0.37A)^2 + (0.82A/1.43)^2 + (0.52A/1.43)^2} = 0.77A$$

The 120Hz ripple current rating at $105^\circ C$ ambient is 0.95A for the $180\mu F$ KMH 400V capacitor. The expected life of the output capacitor may be calculated from the thermal stress analysis:

$$L = L_0 \times 2^{\frac{(105^\circ C + \Delta T_K) - (T_A + \Delta T_O)}{10}}$$

where:

L: expected life time

L_0 : hours of load life at rated ripple current and rated ambient temperature.

ΔT_K : Capacitor internal temperature rise at rated condition. $\Delta T_K = (I^2 R)/(KA)$. Where I is the rated current, R is capacitor ESR, and KA is a volume constant.

T_A : Operating ambient temperature.

ΔT_O : Capacitor internal temperature rise at operating condition.

In our example $L_0 = 2000$ hours and $\Delta T_K = 10^\circ C$ at rated 0.95A. ΔT_O can then be calculated from:

$$\Delta T_K = (I_{RMS}/0.95A)^2 \times \Delta T_K = (0.77A/0.95A)^2 \times 10^\circ C = 6.6^\circ C$$

Assuming the operating ambient temperature is $60^\circ C$, the approximate life time is:

$$L_0 \approx 2000 \times 2^{\frac{(105^\circ C + 10^\circ C) - (60^\circ C + 6.6^\circ C)}{10}} \approx 57,000 \text{ hours}$$

For longer life, a capacitor with a higher ripple current rating or parallel capacitors should be used.

TYPICAL APPLICATION

300W, 382V Preregulator

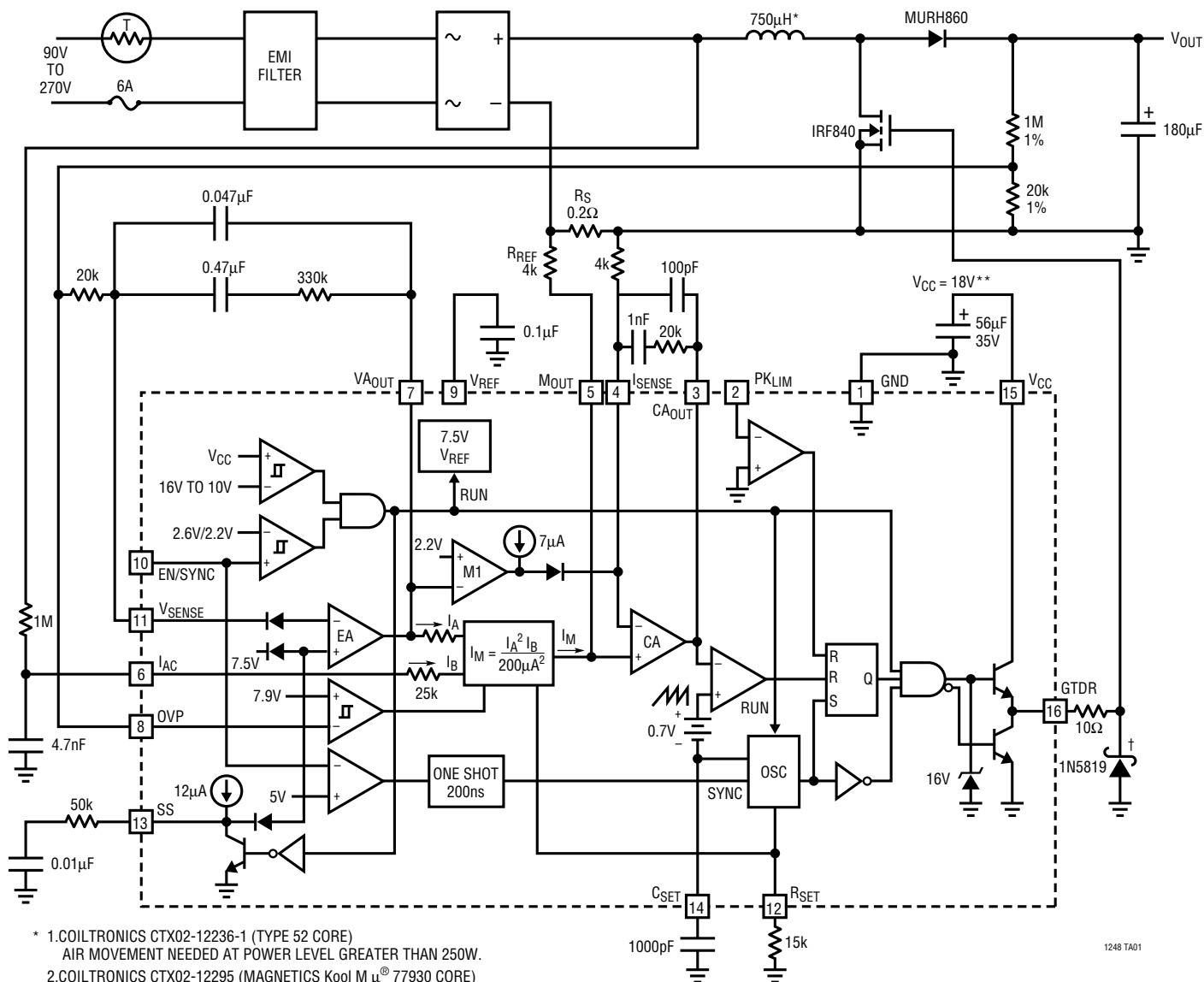

- * 1.COILTRONICS CTX02-12236-1 (TYPE 52 CORE)
AIR MOVEMENT NEEDED AT POWER LEVEL GREATER THAN 250W.
- 2.COILTRONICS CTX02-12295 (MAGNETICS Kool M µ® 77930 CORE)
- ** SEE STARTUP AND SUPPLY VOLTAGE SECTION FOR V_{CC} GENERATOR.
- † THIS SCHOTTKY DIODE IS TO CLAMP GTDR WHEN MOS SWITCH TURNS OFF. PARASITIC INDUCTANCE AND GATE CAPACITANCE MAY TURN ON CHIP SUBSTRATE DIODE AND CAUSE ERRATIC OPERATIONS IF GTDR IS NOT CLAMPED.

Kool Mµ is a registered trademark of Magnetics, Inc.

PACKAGE DESCRIPTION Dimensions in inches (millimeters) unless otherwise noted.

**N Package
16-Lead Plastic DIP**

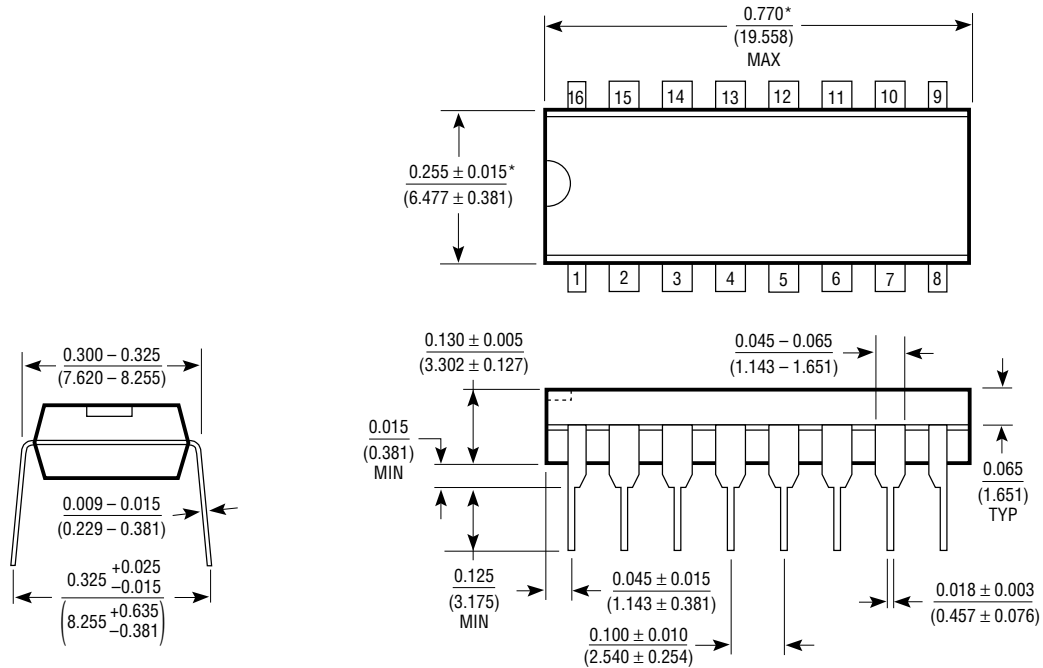

*THESE DIMENSIONS DO NOT INCLUDE MOLD FLASH OR PROTRUSIONS.
MOLD FLASH OR PROTRUSIONS SHALL NOT EXCEED 0.010 INCH (0.254mm).

**S Package
16-Lead Narrow Plastic SOIC**

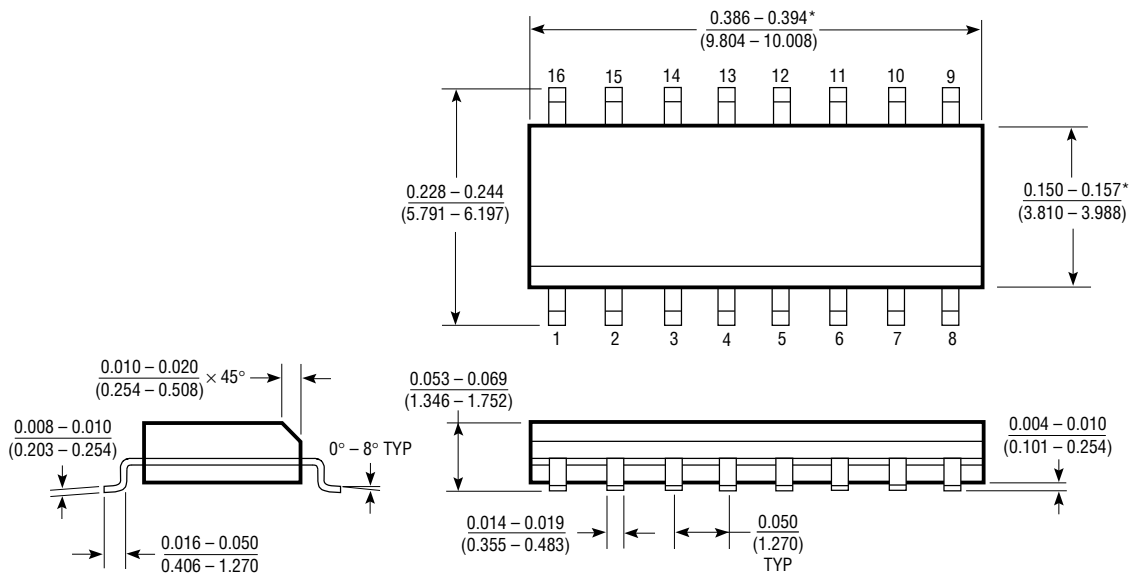

*THESE DIMENSIONS DO NOT INCLUDE MOLD FLASH OR PROTRUSIONS.
MOLD FLASH OR PROTRUSIONS SHALL NOT EXCEED 0.006 INCH (0.15mm).