

NPN Silicon RF Transistor

- For low noise, low-power amplifiers in mobile communication systems (pager, cordless telephone) at collector currents from 0.2 mA to 8 mA
- $f_T = 7$ GHz
 $F = 1.5$ dB at 900 MHz
- Two (galvanic) internal isolated Transistors in one package

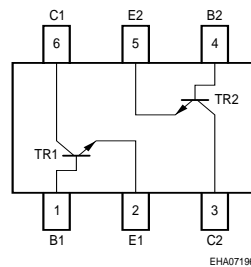
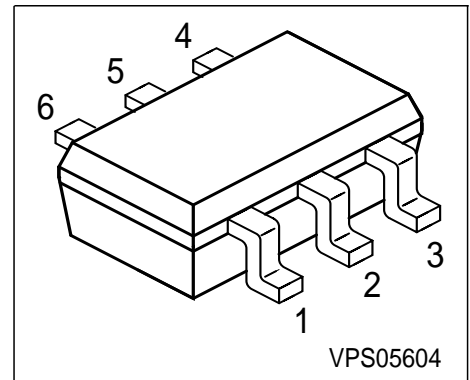

ESD: Electrostatic discharge sensitive device, observe handling precaution!

Type	Marking	Pin Configuration						Package
BFS480	REs	1=B	2=E	3=C	4=B	5=E	6=C	SOT363

Maximum Ratings

Parameter	Symbol	Value	Unit
Collector-emitter voltage	V_{CEO}	8	V
Collector-emitter voltage	V_{CES}	10	
Collector-base voltage	V_{CBO}	10	
Emitter-base voltage	V_{EBO}	2	
Collector current	I_C	10	mA
Base current	I_B	1.2	
Total power dissipation $T_S \leq 112$ °C ¹⁾	P_{tot}	80	mW
Junction temperature	T_j	150	°C
Ambient temperature	T_A	-65 ... 150	
Storage temperature	T_{stg}	-65 ... 150	

Thermal Resistance

Junction - soldering point ²⁾	R_{thJS}	≤ 470	K/W
--	------------	------------	-----

¹⁾ T_S is measured on the collector lead at the soldering point to the pcb

²⁾ For calculation of R_{thJA} please refer to Application Note Thermal Resistance

Electrical Characteristics at $T_A = 25^\circ\text{C}$, unless otherwise specified.

Parameter	Symbol	Values			Unit
		min.	typ.	max.	
DC characteristics					
Collector-emitter breakdown voltage $I_C = 1 \text{ mA}, I_B = 0$	$V_{(BR)CEO}$	8	-	-	V
Collector-emitter cutoff current $V_{CE} = 10 \text{ V}, V_{BE} = 0$	I_{CES}	-	-	100	μA
Collector-base cutoff current $V_{CB} = 8 \text{ V}, I_E = 0$	I_{CBO}	-	-	100	nA
Emitter-base cutoff current $V_{EB} = 1 \text{ V}, I_C = 0$	I_{EBO}	-	-	1	μA
DC current gain $I_C = 3 \text{ mA}, V_{CE} = 5 \text{ V}$	h_{FE}	30	100	200	-

Electrical Characteristics at $T_A = 25^\circ\text{C}$, unless otherwise specified.

Parameter	Symbol	Values			Unit
		min.	typ.	max.	
AC characteristics (verified by random sampling)					
Transition frequency $I_C = 6 \text{ mA}$, $V_{CE} = 5 \text{ V}$, $f = 500 \text{ MHz}$	f_T	5	7.5	-	GHz
Collector-base capacitance $V_{CB} = 5 \text{ V}$, $f = 1 \text{ MHz}$	C_{cb}	-	0.23	0.4	pF
Collector-emitter capacitance $V_{CE} = 5 \text{ V}$, $f = 1 \text{ MHz}$	C_{ce}	-	0.1	-	
Emitter-base capacitance $V_{EB} = 0.5 \text{ V}$, $f = 1 \text{ MHz}$	C_{eb}	-	0.23	-	
Noise figure $I_C = 1.5 \text{ mA}$, $V_{CE} = 5 \text{ V}$, $Z_S = Z_{Sopt}$, $f = 900 \text{ MHz}$ $f = 1.8 \text{ GHz}$	F	-	1.5	-	dB
		-	2	-	
Power gain, maximum stable ¹⁾ $I_C = 3 \text{ mA}$, $V_{CE} = 5 \text{ V}$, $Z_S = Z_{Sopt}$, $Z_L = Z_{Lopt}$, $f = 900 \text{ MHz}$ $f = 1.8 \text{ GHz}$	G_{ms}	-	18	-	
		-	14	-	
Transducer gain $I_C = 3 \text{ mA}$, $V_{CE} = 5 \text{ V}$, $Z_S = Z_L = 50\Omega$, $f = 900 \text{ MHz}$ $f = 1.8 \text{ GHz}$	$ S_{21e} ^2$	-	14	-	
		-	9.5	-	

$$^1G_{ms} = |S_{21} / S_{12}|$$

Total power dissipation $P_{tot} = f(T_S)$

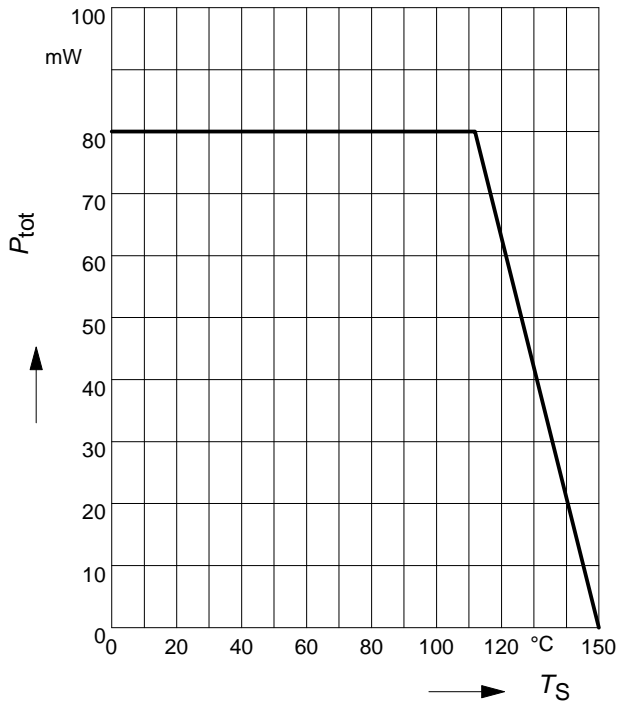

Permissible Pulse Load $R_{thJS} = f(t_p)$

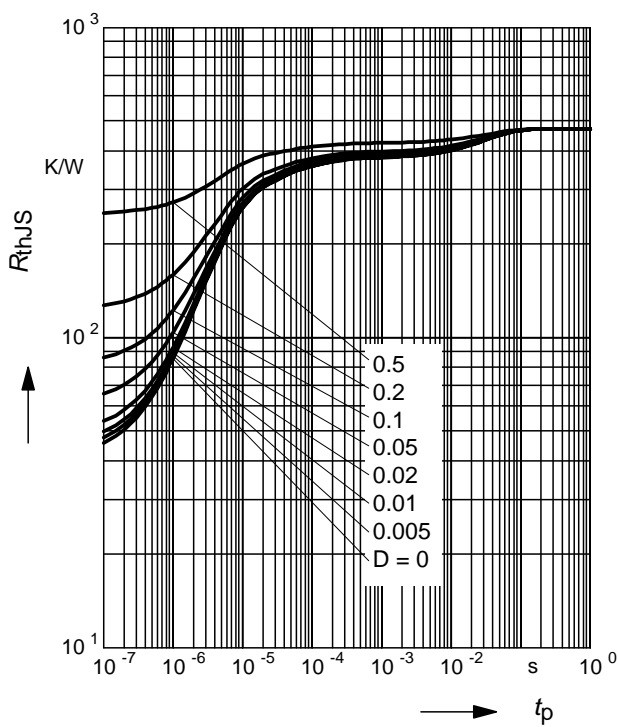

Permissible Pulse Load

$P_{totmax}/P_{totDC} = f(t_p)$

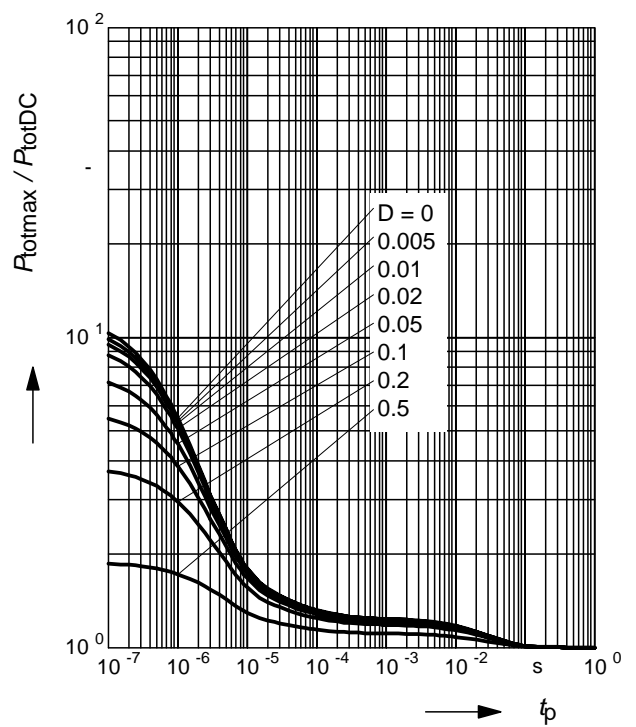

Collector-base capacitance $C_{cb} = f(V_{CB})$

$f = 1\text{MHz}$

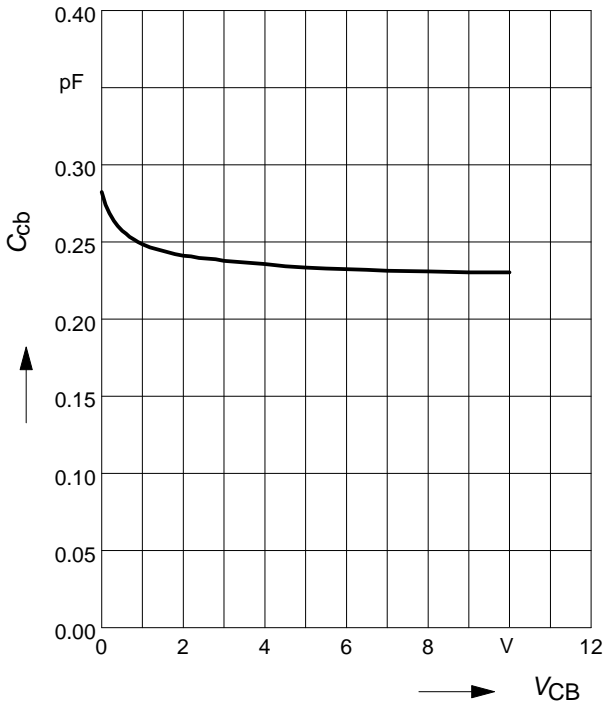

Transition frequency $f_T = f(I_C)$

$V_{CE} = \text{Parameter}$

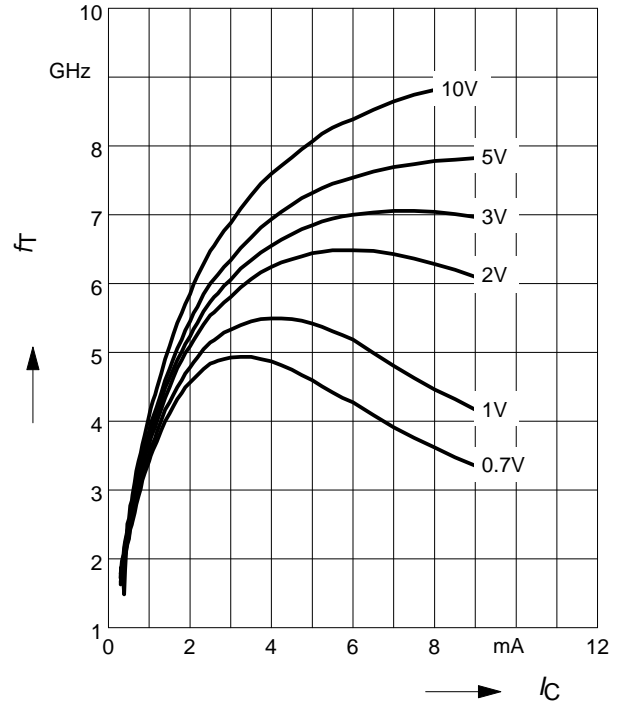

Power Gain $G_{ma}, G_{ms} = f(I_C)$

$f = 0.9\text{GHz}$

$V_{CE} = \text{Parameter}$

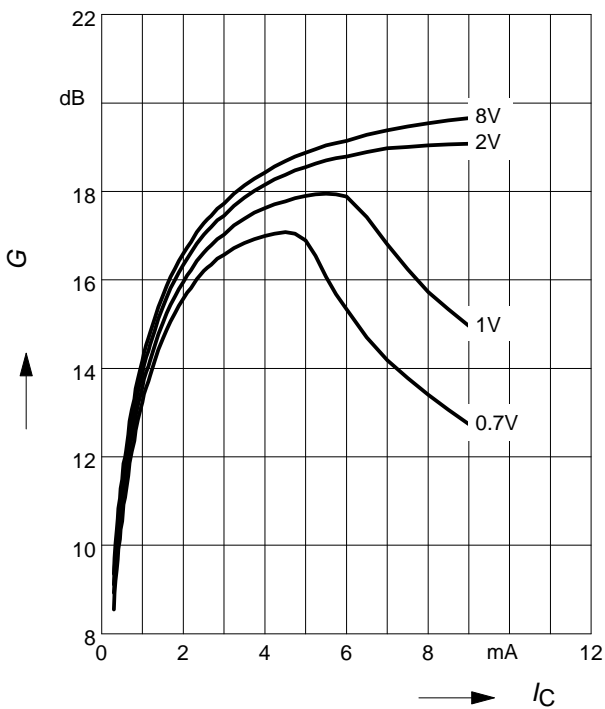

Power Gain $G_{ma}, G_{ms} = f(I_C)$

$f = 1.8\text{GHz}$

$V_{CE} = \text{Parameter}$

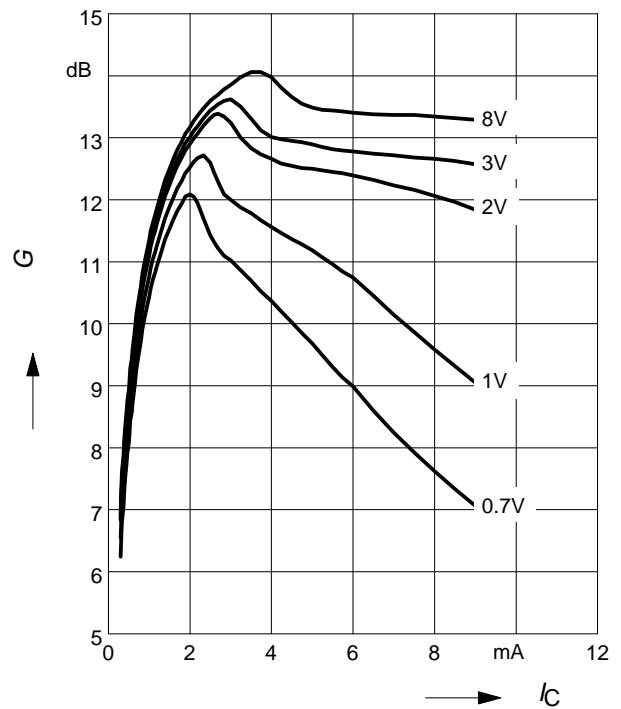

Power Gain $G_{ma}, G_{ms} = f(V_{CE})$: _____

$|S_{21}|^2 = f(V_{CE})$: -----

f = Parameter

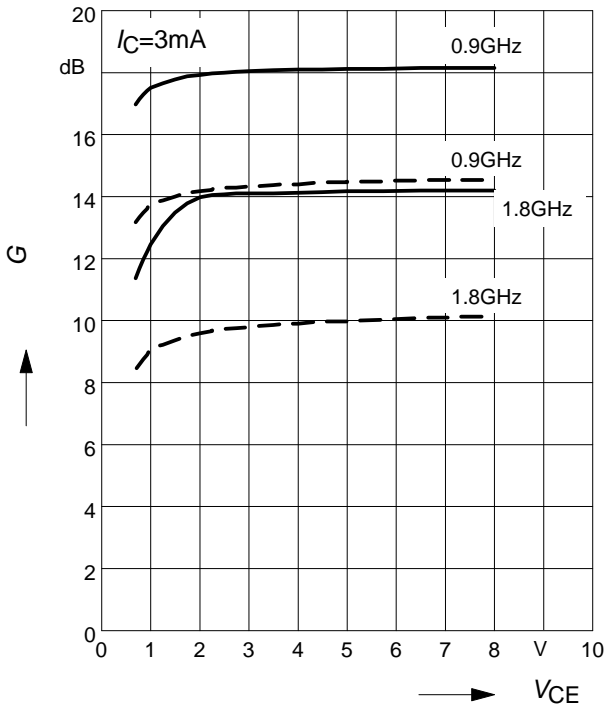

Intermodulation Intercept Point $IP_3 = f(I_C)$

(3rd order, Output, $Z_S = Z_L = 50\Omega$)

V_{CE} = Parameter, $f = 900\text{MHz}$

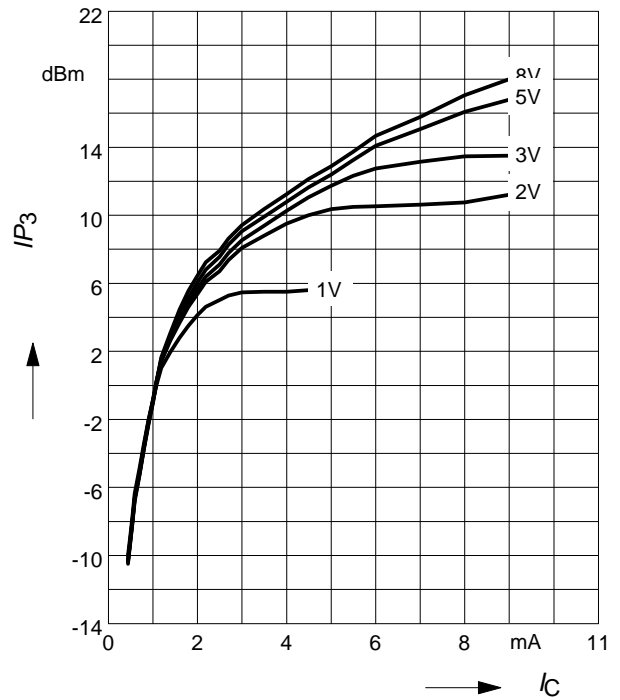

Power Gain $G_{ma}, G_{ms} = f(f)$

V_{CE} = Parameter

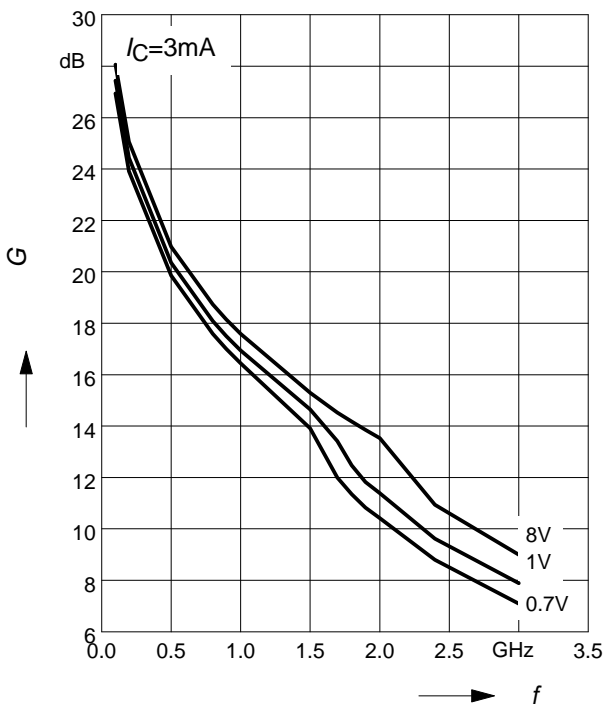

Power Gain $|S_{21}|^2 = f(f)$

V_{CE} = Parameter

