

FEATURES

- **Very High CTR at $I_F=1.0$ mA, $V_{CE}=0.5$ V**
 - SFH618A-2, 63–125%
 - SFH618A-3, 100–200%
 - SFH618A-4, 160–320%
 - SFH618A-5, 250–500%
 - SFH628A-2, 63–200%
 - SFH628A-3, 100–320%
 - SFH628A-4, 160–500%
- **Specified Minimum CTR at $I_F=0.5$ mA**
 - SFH618A, $V_{CE}=1.5$ V: $\geq 32\%$ (typical 120%)
 - SFH628A, $V_{CE}=1.5$ V: $\geq 50\%$ (typical 160%)
- **Good CTR Linearity Depending on Forward Current**
- **Low CTR Degradation**
- **High Collector-emitter Voltage, $V_{CEO}=55$ V**
- **Isolation Test Voltage, 5300 V_{RMS}**
- **Low Coupling Capacitance**
- **Field-Effect Stable by TRIOS (Transparent Ion Shield)**
- **End-Stackable, 0.100" (2.54 mm) Spacing**
- **High Common-mode Interference Immunity (Unconnected Base)**
- **Underwriters Lab File #52744**
- **VDE 0884 Available with Option 1**
- **SMD Option — See SFH6186/6286 Data Sheet**

APPLICATIONS

- **Telecom**
- **Industrial Controls**
- **Battery Powered Equipment**
- **Office Machines**

DESCRIPTION

The SFH618A/628A feature a high current transfer ratio, low coupling capacitance and high isolation voltage. These couplers have a GaAs infrared emitting diode emitter, which is optically coupled to a silicon planar phototransistor detector, and is incorporated in a plastic DIP-4 package.

The coupling devices are designed for signal transmission between two electrically separated circuits.

The couplers are end-stackable with 2.54 mm lead spacing.

Creepage and clearance distances of >8.0 mm are achieved with option 6. This version complies with IEC 950 (DIN VDE 0805) for reinforced insulation up to an operation voltage of 400 V_{RMS} or DC.

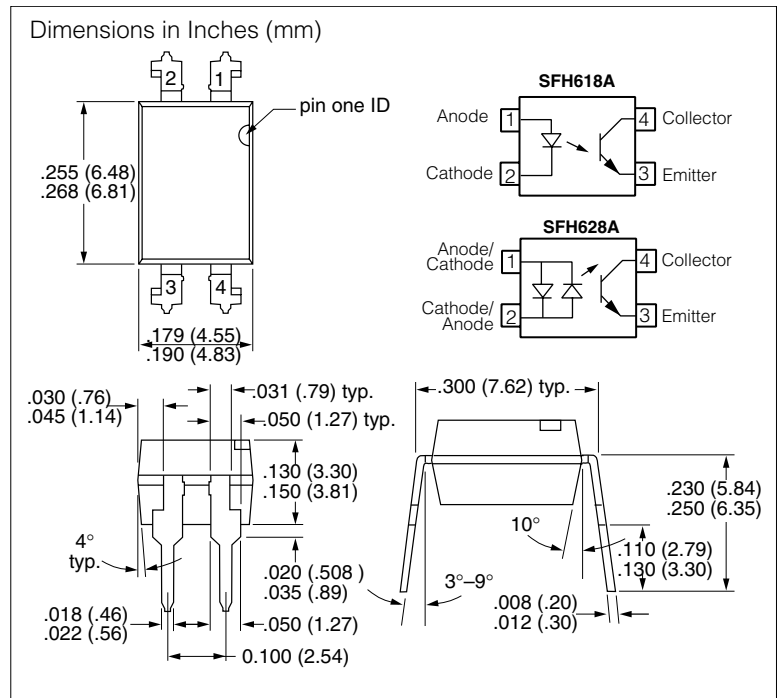

Maximum Ratings

Emitter

Reverse Voltage (SFH618A)	6.0 V
DC Forward Current (SFH628A)	±50 mA
Surge Forward Current ($t_p \leq 10$ μ s) (SFH628A)	±2.5 A
Total Power Dissipation	70 mW

Detector

Collector-emitter Voltage	55 V
Emitter-collector Voltage	7.0 V
Collector Current	50 mA
Collector Current ($t_p \leq 1.0$ ms)	100 mA
Total Power Dissipation	150 mW

Package

Isolation Test Voltage between Emitter and Detector, refer to Climate DIN 40046, part 2, Nov. 74	5300 V _{RMS}
Creepage Distance	≥ 7.0 mm
Clearance	≥ 7.0 mm
Insulation Thickness between Emitter and Detector	≥ 0.4 mm
Comparative Tracking Index per DIN IEC 112/VDE0 303, part 1	175
Isolation Resistance	
$V_{IO}=500$ V, $T_A=25^\circ\text{C}$	$\geq 10^{12}$ Ω
$V_{IO}=500$ V, $T_A=100^\circ\text{C}$	$\geq 10^{11}$ Ω
Storage Temperature Range	-55 to +150°C
Ambient Temperature Range	-55 to +100°C
Junction Temperature	100°C
Soldering Temperature (max. 10 s. Dip Soldering)	
Distance to Seating Plane ≥ 1.5 mm)	260°C

Characteristics ($T_A=25^\circ\text{C}$)

Description		Symbol	Min.	Typ.	Max.	Unit	Condition
Emitter							
Forward Voltage		V_F	—	1.1	1.5	V	$I_F=5.0\text{ mA}$
Reverse Current	SFH618A	I_R	—	.01	10	μA	$V_R=6.0\text{ V}$
Capacitance	SFH618A SFH628A	C_0	—	25 45	—	pF	$V_R=0\text{ V}$, $f=1.0\text{ MHz}$
Thermal Resistance		R_{thJA}	—	1070	—	K/W	—
Detector							
Collector-emitter Leakage Current		I_{CEO}	—	10	200	nA	$V_{CE}=10\text{ V}$
Capacitance		C_{CE}	—	7	—	pF	$V_{CE}=5.0\text{ V}$, $f=1.0\text{ MHz}$
Thermal Resistance		R_{thJA}	—	500	—	K/W	—
Package							
Collector-emitter Saturation Voltage	SFH618A-2	V_{CEsat}	—	0.25	0.4	V	$I_C=0.32\text{ mA}$, $I_F=1.0\text{ mA}$
	SFH618A-3		—	0.25	0.4		$I_C=0.5\text{ mA}$, $I_F=1.0\text{ mA}$
	SFH618A-4		—	0.25	0.4		$I_C=0.8\text{ mA}$, $I_F=1.0\text{ mA}$
	SFH618A-5		—	0.25	0.4		$I_C=1.25\text{ mA}$, $I_F=1.0\text{ mA}$
Collector-emitter Saturation Voltage	SFH628A-2	V_{CEsat}	—	0.25	0.4	V	$I_C=0.5\text{ mA}$, $I_F=\pm 1.0\text{ mA}$
	SFH628A-3		—	0.25	0.4		$I_C=0.8\text{ mA}$, $I_F=\pm 1.0\text{ mA}$
	SFH628A-4		—	0.25	0.4		$I_C=1.25\text{ mA}$, $I_F=\pm 1.0\text{ mA}$
Coupling Capacitance	—	C_C	—	0.25	—	pF	—
Coupling Transfer Ratio	SFH618A-2	I_C/I_F	63	—	125	%	$I_F=1.0\text{ mA}$, $V_{CE}=0.5\text{ V}$
	SFH618A-2		32	75	—		$I_F=0.5\text{ mA}$, $V_{CE}=1.5\text{ V}$
	SFH618A-3	I_C/I_F	100	—	200	%	$I_F=1.0\text{ mA}$, $V_{CE}=0.5\text{ V}$
	SFH618A-3		50	120	—		$I_F=0.5\text{ mA}$, $V_{CE}=1.5\text{ V}$
	SFH618A-4	I_C/I_F	160	—	320	%	$I_F=1.0\text{ mA}$, $V_{CE}=0.5\text{ V}$
	SFH618A-4		80	200	—		$I_F=0.5\text{ mA}$, $V_{CE}=1.5\text{ V}$
	SFH618A-5	I_C/I_F	250	—	500	%	$I_F=1.0\text{ mA}$, $V_{CE}=0.5\text{ V}$
	SFH618A-5		125	300	—		$I_F=0.5\text{ mA}$, $V_{CE}=1.5\text{ V}$
Coupling Transfer Ratio	SFH628A-2	I_C/I_F	63	—	200	%	$I_F=\pm 1.0\text{ mA}$, $V_{CE}=0.5\text{ V}$
	SFH628A-2		32	100	—		$I_F=\pm 0.5\text{ mA}$, $V_{CE}=1.5\text{ V}$
	SFH628A-3	I_C/I_F	100	—	320	%	$I_F=\pm 1.0\text{ mA}$, $V_{CE}=0.5\text{ V}$
	SFH628A-3		50	160	—		$I_F=\pm 0.5\text{ mA}$, $V_{CE}=1.5\text{ V}$
	SFH628A-4	I_C/I_F	160	—	500	%	$I_F=\pm 1.0\text{ mA}$, $V_{CE}=0.5\text{ V}$
	SFH628A-4		80	250	—		$I_F=\pm 0.5\text{ mA}$, $V_{CE}=1.5\text{ V}$

Figure 1. Current Transfer Ratio (typ.)
 $V_{CE}=0.5\text{ V}$, $C_{TR}=f(T_A)$

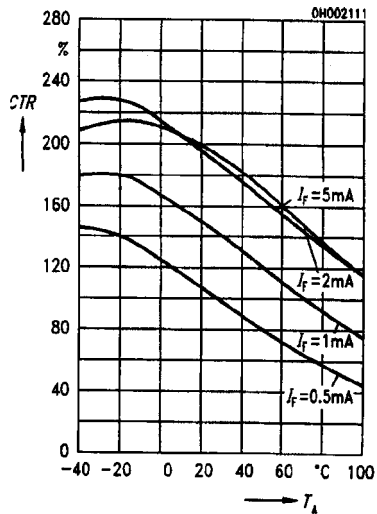

Figure 2. Current Transfer Ratio (typ.)
 $V_{CE}=1.5\text{ V}$, $C_{TR}=f(T_A)$

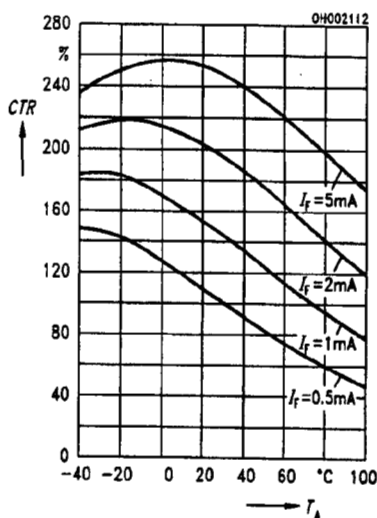

Figure 3. Diode Forward Voltage
 $T_A=25^\circ\text{C}$, $V_F=f(I_F)$

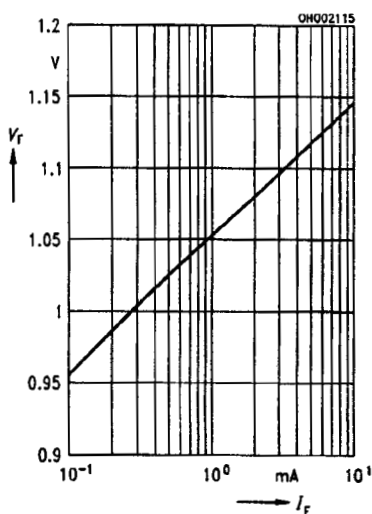

Figure 4. Diode Forward Voltage
 $I_F=1.0\text{ mA}$, $V_F=f(T_A)$

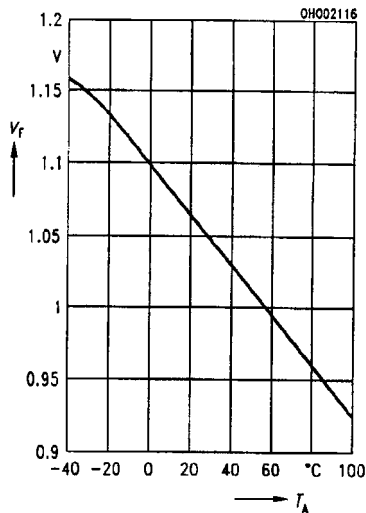

Figure 5. Transistor Capacitance
 $T_A=25^\circ\text{C}$, $f=1.0\text{ MHz}$, $C_{CE}=f(V_{CE})$

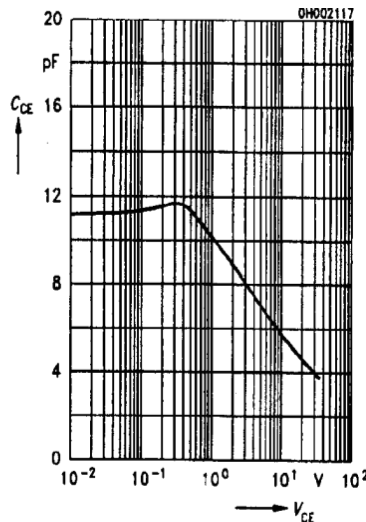

Figure 6. Output Characteristics
 $T_A=25^\circ\text{C}$, $C_E=f(V_{CE}, I_F)$

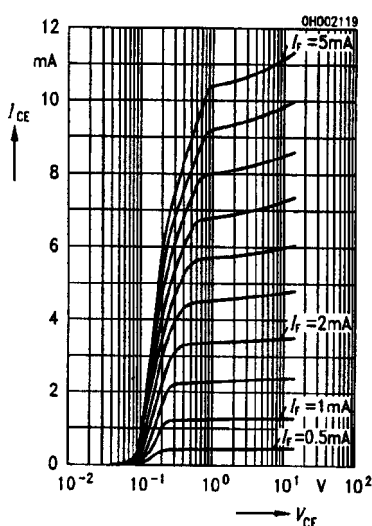

Figure 7. Permissible Forward Current
 $I_F=f(T_A)$

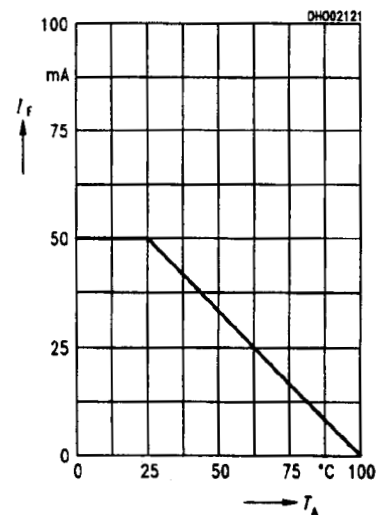

Figure 8. Permissible Power Dissipation
 $P_{tot}=f(T_A)$

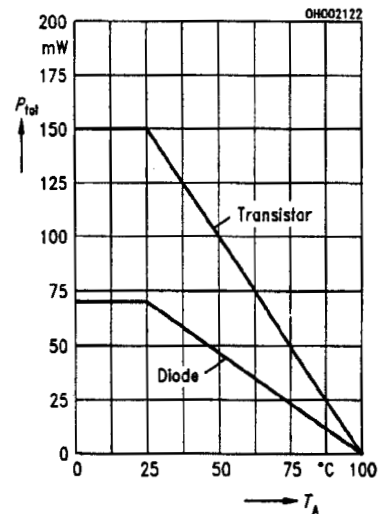
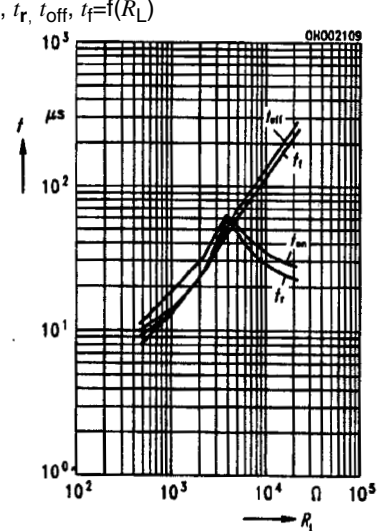

Figure 9. Switching Times (typ.)
 $T_A=25^\circ\text{C}$, $I_F=1.0\text{ mA}$, $V_{CC}=5.0\text{ V}$
 $t_{on}, t_r, t_{off}, t_f=f(R_L)$



Switching Times, typical

$V_{CC}=5.0\text{ V}$, $I_C=2.0\text{ mA}$, $R_L=100\ \Omega$, $T_A=25^\circ\text{C}$

Turn-on Time	t_{on}	6.0	μs
Rise Time	t_r	3.5	
Turn-off Time	t_{off}	5.5	
Fall Time	t_f	5.0	

Figure 10. Test Circuit—SFH618A

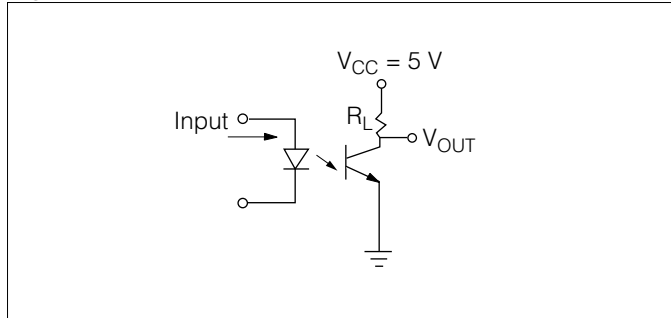

Figure 11. Test Circuit—SFH628A

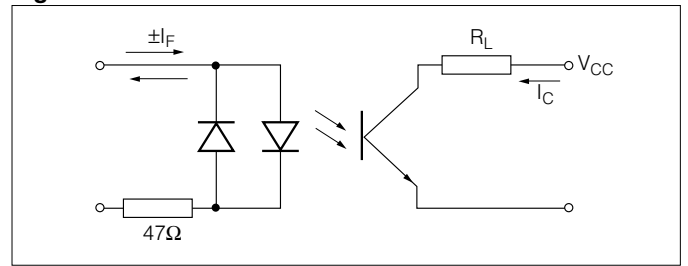

Figure 12. Test Circuit and Waveforms

