

## Features

- Efficiency up to 95%, Non isolated, no need for heatsinks
- Pin-out compatible with LM78XX Linears
- Low profile (L\*W\*H=11.5\*8.5\*17.5mm)
- Wide input range (4.75V ~ 18V)
- Short circuit protection, Thermal shutdown
- Non standard outputs available as specials between 1.5V ~ 6.5V
- Low ripple and noise
- "L" Version with 90° pins

**INNOLINE**  
DC/DC-Converter

**R-78Bxx-**

**1.5(L)**  
**Series**

**1.5 AMP**

**SIP3**

**Single Output**

### Selection Guide

Part Number*	Input Range (V)	Output Voltage (V)	Output Current (A)	Efficiency (%)	
				Min. Vin	Max. Vin
SIP3	(V)	(V)	(A)	(%)	(%)
R-78B1.5-1.5	4.75 – 18	1.5	1.5	83	78
R-78B1.8-1.5	4.75 – 18	1.8	1.5	85	81
R-78B2.5-1.5	4.75 – 18	2.5	1.5	88	84
R-78B3.3-1.5	4.75 – 18	3.3	1.5	91	88
R-78B5.0-1.5	6.5 – 18	5.0	1.5	94	92
R-78B6.5-1.5	8.0 – 18	6.5	1.5	95	93

\* add Suffix "L" for 90° bent pins, e.g. R-78B5.0-1.5L



**RECOM**  
INTERNATIONAL POWER

### Description

The R-78Bxx-1.5 Series high efficiency switching regulators are ideally suited to replace 78xx linear regulators and are pin compatible. The efficiency of up to 95% means that very little energy is wasted as heat so there is no need for any heat sinks with their additional space and mounting costs. The L-Version with 90° pins allows direct replacement for laid-flat regulators where component height is at a premium. Low ripple and noise figures and a short circuit input current of typically only 10mA round off the specifications of this versatile converter series.

## Derating-Graph (Ambient Temperature)

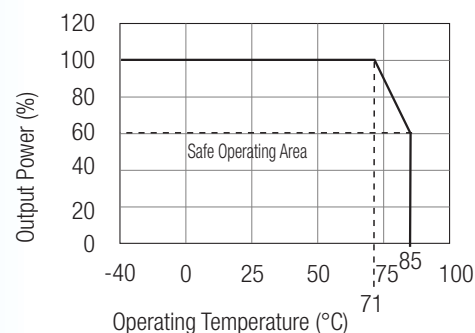

**Specifications (refer to the standard application circuit, Ta: 25°C, minimum load = 10%)**

Characteristics	Conditions	Min.	Typ.	Max.
Input Voltage Range	All Series, see Selection Guide	4.75		18.0V
Output Voltage Range (for customized parts)	All Series	1.5		6.5V
Output Current (see Note 1)	All Series	0		1500mA
Output Current Limit	All Series			5000mA
Short Circuit Input Current	All Series		60	80mA
Internal Power Dissipation				0.65W
Short Circuit Protection			Continuous, automatic recovery	
Output Voltage Accuracy (At 100% Load)	All Series		±2	±3%
Line Voltage Regulation (Vin = min. to max. at full load)	All Series		0.2	0.4%
Load Regulation (10% to 100% full load)	All Series		20	25mV
Dynamic Load Stability (with Output Capacitor=100µF)	100% <-> 50% load		±80	±120mV
	Transient Recovery Time		1.0	1.5ms
Ripple & Noise (10% to 100% full load)	All Series		15	30mVp-p
Temperature Coefficient	-40°C ~ +85°C ambient			0.015%/°C
Max capacitance Load				1000µF
Switching Frequency		300	340	380kHz
Quiescent Current	Vin = min. to max. at 0% load		7	9mA
Input Reflected Ripple Current	All Series		150	200mA <sub>p-p</sub>
Operating Temperature Range		-40°C		+85°C
Operating Case Temperature				+100°C
Storage Temperature Range		-55°C		+125°C
Case Thermal Impedance				60°C / W
Thermal Shutdown	Internal IC junction		+160°C	
Relative Humidity				95% RH
Case Material			Epoxy with Non-Conductive Plastic Case(UL94V-0)	
Package Weight				4g
MTBF (+25°C) (+71°C)	} Detailed Information see Application Notes chapter "MTBF"	using MIL-HDBK 217F		3250 x 10 <sup>3</sup> hours
		using MIL-HDBK 217F		1059 x 10 <sup>3</sup> hours

Note 1: The converter requires a minimum load of 6mA to start up properly. Once started, the load can be reduced to 0%

**Standard Application Circuit**

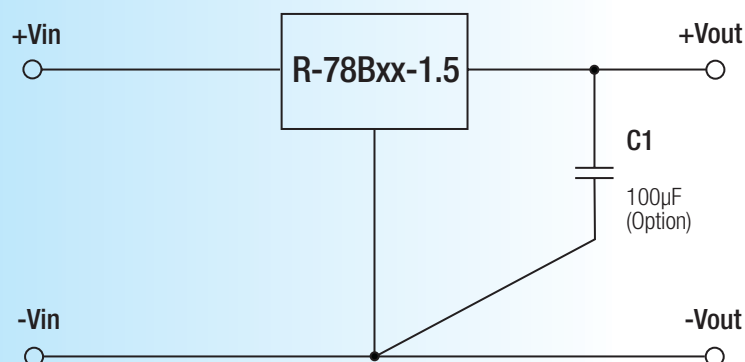

Add a blocking diode to Vout if current can flow backwards into the output, as this can damage the converter.

**Characteristics**

## Efficiency

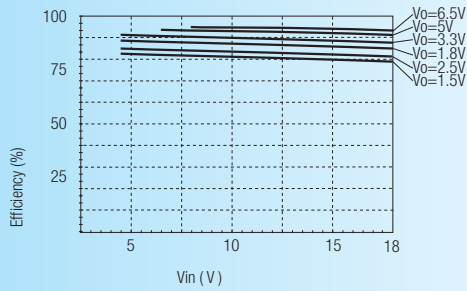

Efficiency Vs Vin (Full Load)

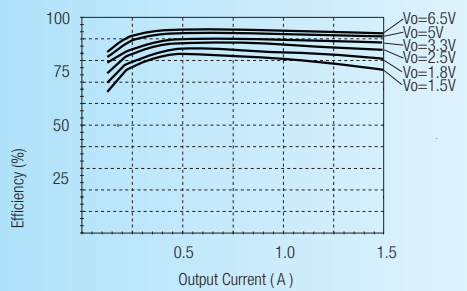

Efficiency Vs Load (Vin=Max)

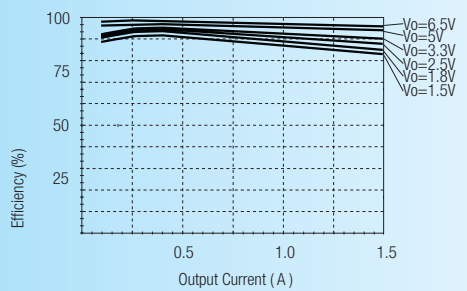

Efficiency Vs Load (Vin=Min)

## Ripple

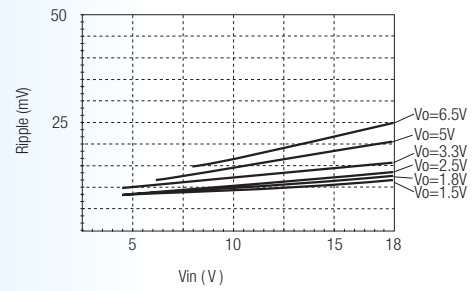

Ripple Vs Vin (Full Load)

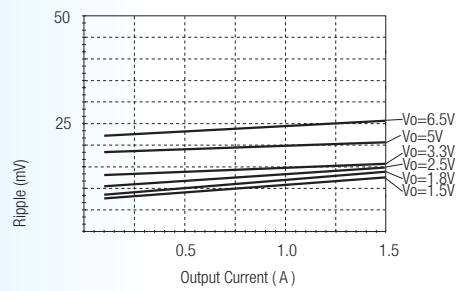

Ripple Vs Load (Vin=Max)

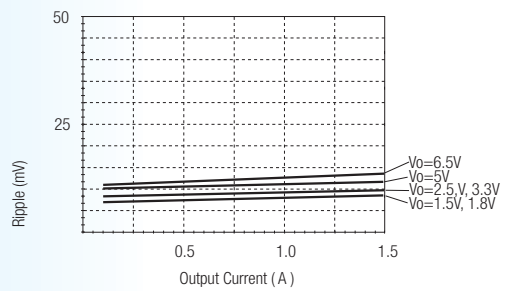

Ripple Vs Load (Vin=Min)

**Application Examples**

**High efficiency multiple output**

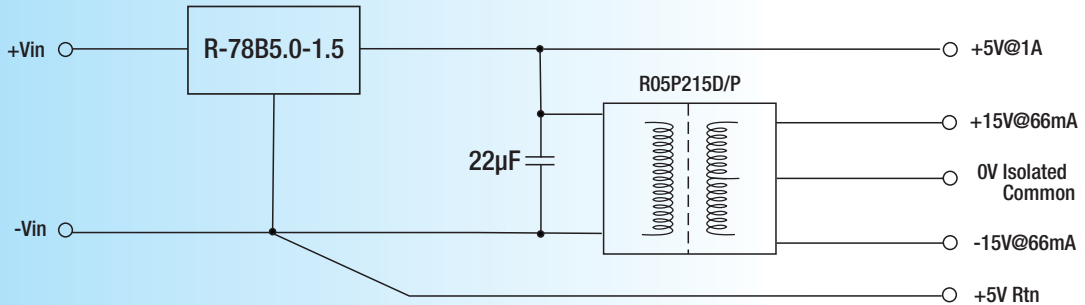

- Wide input range suits both 12V and 7.2V battery packs
- 5.2kV isolated short circuit protected outputs for analogue circuits, e.g. medical grade interface
- High efficiency +5V/1A protected output for digital circuits
- Further decoupling filtering may be necessary between the converters

**Isolated, wide Input range, Distributed Power Architecture (Point of Load)**

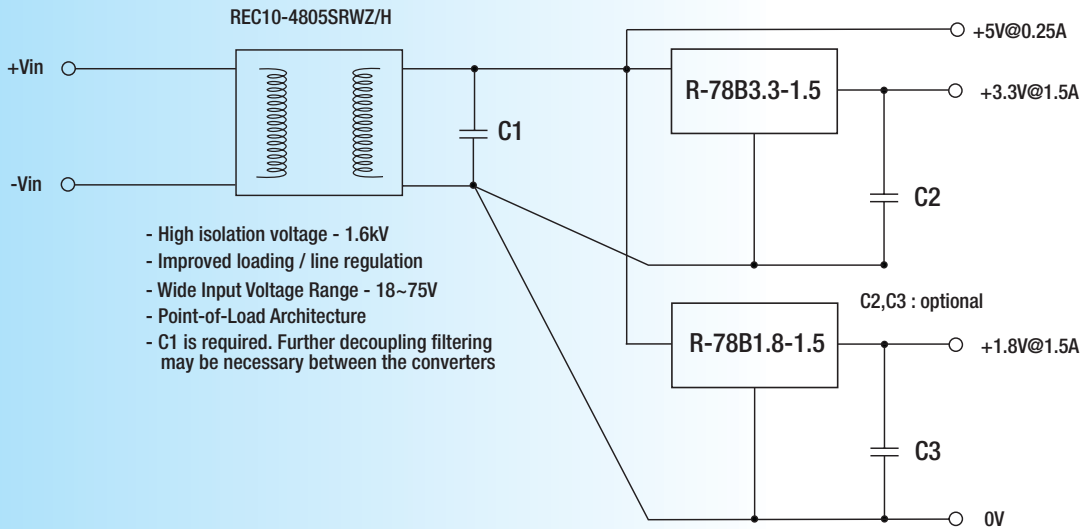

- High isolation voltage - 1.6kV
- Improved loading / line regulation
- Wide Input Voltage Range - 18~75V
- Point-of-Load Architecture
- C1 is required. Further decoupling filtering may be necessary between the converters

**Package Style and Pinning (mm)**

**SIP3 PIN Package**

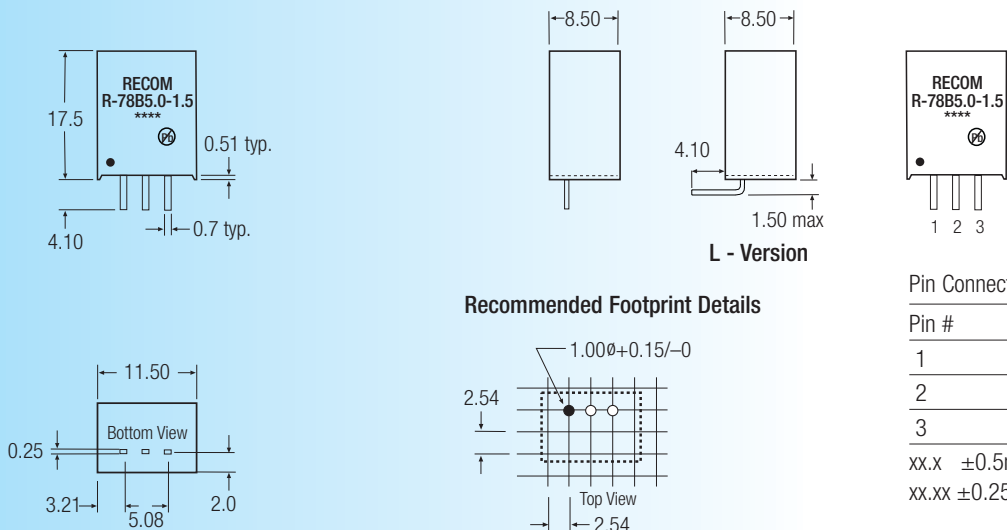

Pin Connections	
Pin #	
1	+Vin
2	GND
3	+Vout
xx.x	±0.5mm
xx.xx	±0.25mm