

Ordering No. 15 65 33
CON-WLSW-24V

Level controller for conducting liquids 24V OEM version without housing

Connection and operating instructions



- Level controller for conducting liquids
- Simultaneous monitoring of 4 levels
- Two independent circuits for fill/empty
- Indication of fill condition and operating status through 8 LED's
- Two high rating potential free relays with NO/NC contacts
- Operating voltage depending on model:
12V/24V AC/DC or 230V AC

LEVEL CONTROLLER FOR CONDUCTING LIQUIDS



Contents

1	General dangers and precautions	2
1.1	Instructions regarding documentation.....	2
1.2	Safety instructions.....	2
2	Description.....	3
2.1	Functional description.....	3
2.2	Operating sequence diagram.....	4
2.3	Model description.....	5
2.4	Scope of supply.....	5
3	Technical Data.....	6
4	Ordering information.....	6
5	Assembly, adjustment and configuration.....	7
5.1	Electrical connection.....	7
5.1.1	Safety instructions.....	7
5.1.2	Lines to the sensor set-up.....	7
5.1.3	Operating voltage.....	7
5.1.4	Load circuit.....	8
5.2	Switching point adjustment.....	9
5.3	Light emitting diodes (LEDs).....	9
5.4	Configuration of operating mode.....	10
5.5	Connection of user's own sensors.....	10
5.5.1	Pin configuration of input socket (RJ12).....	10
5.6	Construction of sensor.....	11
6	Guarantee.....	12
6.1	Repair services.....	12



1 General dangers and precautions

1.1 Instructions regarding documentation



Please carefully read the following instructions before putting into operation! The symbols used in the operating manual are to make you careful, before hand, regarding safety considerations and dangers. But, in no way, these symbols can substitute the text of the associated safety instructions. Therefore, the instructions should also be always read in full detail!



This symbol indicates likely danger for persons, material or environment. The information provided in the associated text should be duly followed to avoid any kind of risk.



This symbol refers to important application notes and tips, which are necessary for successful working and should to be absolutely followed to ensure good results.

1.2 Safety instructions



Please read these instructions, carefully and completely, before putting the device into operation. Please also comply and follow the safety instructions, specially the safety regulations related to the devices to be operated on mains supply.

The product should be installed and used only for the intended applications as described in these instructions. Any other application is not advised and shall lead to loss of guarantee and exclusion from liability. This also applies to any changes or other modifications carried out on the device by the user.

Defective safety devices should be replaced with same type of items in respect of trip current rating, tripping characteristics, and mechanical fitment dimensions. Bypassing protections lead to a considerable safety risk, and hence, is not allowed under any circumstances.

The connection terminals may be wired to mains voltage. Contact with live parts lead to fatal dangers. The mounting and maintenance operations should be carried out by only trained personnel, who are authorised on the basis of technical training in this field. The applicable safety regulations should be followed. The switching device must be assembled in a switching cabinet or a fully closed plastic housing. Mounting and servicing operation should be carried out only after switching off the voltage.

The product is not meant for controlling electrical systems which perform safety related functions. In normal operation also, there is always a danger of malfunctioning due to failure of any component or any other disturbance. The user has to ensure that there are no consequential damages due to malfunctioning or undefined switching status of the relay. This is all the more possible, if heavy loads like heaters or motors are triggered with the relays.



The device is not suitable for use in medical instruments or swimming pools. The user has to take suitable measures (e.g. grounding the metallic container) to take care that there is no danger of electric shock in the medium. The safety regulations applicable for special applications should be absolutely followed by the user ! The controller is only suitable for mounting in dry locations.

The liquids suitable for application of this device are all types of non-combustible, aqueous, non-corrosive and unpolluted liquids e.g. tap water. The device is not suitable for combustible, non-conducting liquids!

2 Description

2.1 Functional description

The control device is used for regulating level of conducting liquids like supply line water, rain water or condensate. The measurement of level in the reservoir is done with the help of electrodes, for which either contact surface of the reservoir walls or self made rod type electrodes can be used.

With two independent circuits, simultaneous monitoring of both minimum and maximum liquid levels and control of two different actuators are possible, for example, an inlet valve and a pump.

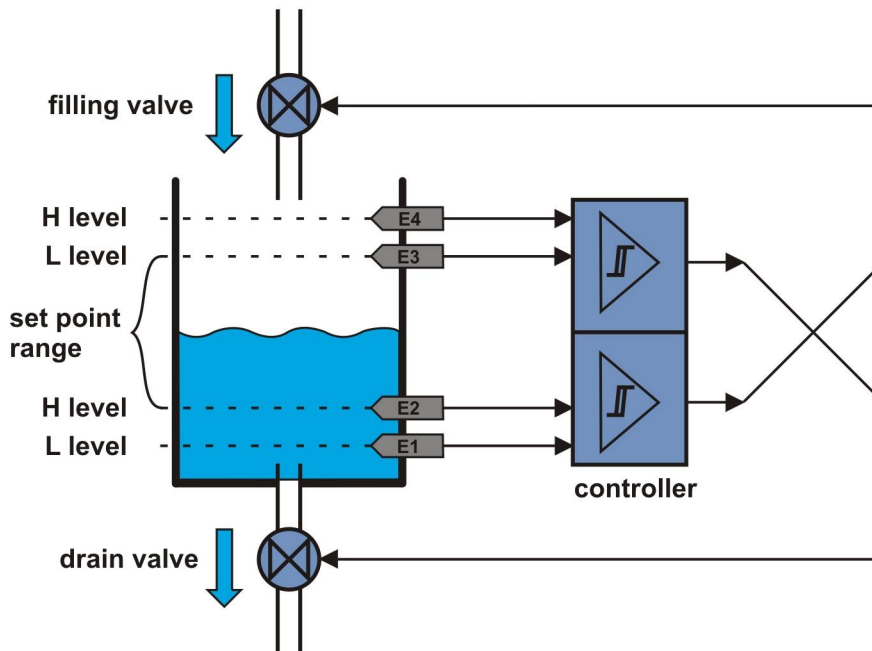

In liquid reservoir, four electrodes (E1..E4) are mounted in the medium, at heights corresponding to the required switching point. A fifth electrode is placed at the bottom of the reservoir (not shown in sketch) which works as the reference electrode.

According to water contact, the fill level is indicated through 4 green LED's L1 to L4. If the reservoir is completely empty, the red LED glows.

For example, the lower pair of electrodes (E1,E2) can be used to control a filling valve at the inlet. After release of the lowest electrode E1, the filling valve is switched ON and switched OFF again on wetting of the second electrode E2 (Hysteresis).

For example, the upper pair of electrodes can be used to control a drain valve or a pump. During contact with the topmost electrode E4, the drain valve is switched ON and again switched OFF after release of the lower electrode E3 (Hysteresis).

The switching behaviour of the system (Filling/Empty) is to be configured over two jumper plugs. The sensitivity of the electrodes can be adjusted through potentiometers (approx. 15k ... 80kOhm).

2.2 Operating sequence diagram

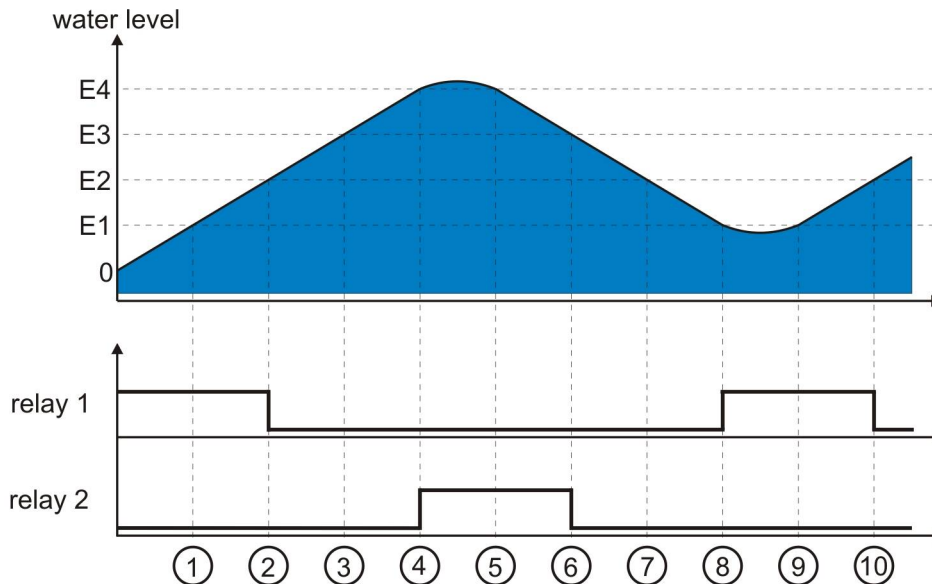

Initial condition : The reservoir is first empty. **The electrode E1** is not in water contact. **Relay 1** is in closed position (because of this e.g. the inlet valve is open). The water level rises in the reservoir. Water contact with the lower **Electrode E1** (1) does not change the relay status and only when **Electrode E2** comes into water contact (2), **Relay 1** switches OFF (as an effect e.g. the inlet valve closes).

Upper level: If the level in the reservoir continues to rise further and reaches **Electrode E3**, **Relay 2** still remains in off state. After the water level reaches **Electrode E4** (4), **Relay 2** is switched ON (and with that e.g. the outflow pump). When the level falls and **Electrode E4** is released free (5), the relay remains closed until **Electrode E3** is released free. (6). This means that between the upper switching ON point **E4** and the lower switching OFF point **E3**, there is a hysteresis gap.

Lower level: If the level continues to fall, the **Electrode E2** becomes free (7). In the reducing level direction, **Relay 1** is kept in off state, till **Electrode E1** is also out of water contact (8). Only then **Relay 1** closes. If again the water level is in rising direction, **Relay 1** remains closed even after water contact with **Electrode E1** (9). Only if **Electrode E2** again comes under water contact, **Relay 1** is switched OFF (10). Hence, the lower level also has a provision of hysteresis margin.

The referred appliances "Inlet valve" or "Pump" are taken only as examples for illustration of the working principle. What appliances are used finally depends on the application. The switching behaviour of both the relays can be reversed through two jumper connections. The two relay circuits work as level regulators and are independent of each other. Hence, it is not necessary to use both the circuits, the device is also suitable for controlling only one level. For this purpose, only two sensing electrodes and a reference electrode are required. In such a case, the second channel (relay and electrode inputs) is not used.

2.3 Model description

There are two relays with NO/NC contacts for control of the appliances (valve/pump). The NO contact can be loaded up to 230V/5A AC and is provided with a varistor for surge suppression. The NC contact can be loaded up to 230V/2A AC.

The model in housing is provided with a 230V AC power supply and a control unit with LEDs for level indication and also pushbuttons for manual switching of the relays.

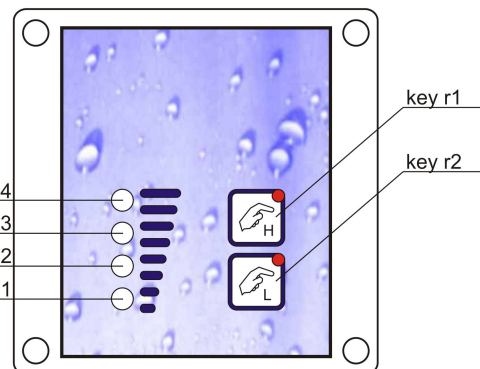

Typical areas of application: Water harvesting/monitoring in rain water cisterns, monitoring of condensate tubs and compressor pressure chamber, boiler, fountains and wells, cattle watering places, control of pumps.

2.4 Scope of supply

The scope of supply of the device is inclusive of 6 core sensor connection lead with RJ12 connector, but without electrodes. Standard sensors are available as accessories or can be easily self made.

The 12V/24V model is supplied as a module (PCB) of size 95 x 75 mm without housing or control panel.

The 230V model is supplied as a complete unit assembled in a housing with an integrated power supply and a control panel. The overall dimensions are 100 x 100 x 60 mm. The cable glands are also included.



3 Technical Data

General	
Operating voltage Type –230V (15 65 46)	230VAC/5 VA max.
Operating voltage Type –MOD12V (15 65 19)	12V..15V DC 65 mA max. 11V..14V AC 80 mA max.
Operating voltage Type –MOD24V (15 65 33)	22V..28V DC 45 mA max. 15V..25 V AC 60 mA max.
Relay	NO/NC contact for resistive load Rating NO contact 230V AC / 5A Rating NC contact 230V AC / 2 A
Surge suppression	NC contact with Varistor VZ 05/390V
Dimensions	Type –230V (15 65 46) 100 x 100 x 60mm Supplied in plastic housing Type –MOD (15 65 19/33) PCB 95 x 75 x 30mm Supplied as a PCB
Sensor side	
Switching point impedance	15-80 kOhm, adjustable over a potentiometer
Measuring voltage	max. 5V _{SS}
Measuring current	< 250µA

4 Ordering information

Switching device and accessories	Ordering No.
Level controller-PCB, for 12 V DC	15 65 19
Level controller -PCB, for 24 V DC	15 65 33
Level controller 230V, in housing with control unit	15 65 46
Housing ET210F, untreated	15 65 59
Control unit with accessories	NIV-BED
Sensor with connection lead	Ordering No.
Cable sensor for water tank with connection lead 5 m	NIV-KABFÜ
Level sensor for compressor pressure chamber (20 bar)	NIV-DRUCKFÜ
Sensor for condensate tub	NIV-KONFÜ
Our sensor catalogue is constantly updated. Sensors for special applications are available on request !	

LEVEL CONTROLLER FOR CONDUCTING LIQUIDS



5 Assembly, adjustment and configuration

5.1 Electrical connection

5.1.1 Safety instructions



Caution ! Touching the high voltage parts may lead to fatal dangers. The mounting and maintenance operations should be carried out by only trained personnel, who are authorised on the basis of technical training in this field. The applicable safety regulations are to be duly followed! The switching device must be assembled in a switching cabinet or in a fully closed plastic housing. Mounting and servicing operations should be carried out only after switching off the voltage. The device should be mounted only at dry locations!



Due to wrong tightening of screws of the connection terminals or by use of inappropriate tool, the terminals can get damaged because of which the insulation or the contact can get disturbed. Badly connected leads can come out during operation and cause a serious risk to safety. Due to contact resistance at terminal connections, there can be increased heat generation which can cause fire. Wrongly wired connections can destroy electric components and cause other damages.

5.1.2 Lines to the sensor set-up

The RJ12-plug connector has been provided for direct connection of sensor lines to the unit. The connector is led through a cable gland provided in the housing and properly mounted through M16 threads. The connection of the ready sensor is to be done as per enclosed data sheet.

The connection length of self made sensing set-up should not exceed 5 m. For short connection lengths up to approx. 3 m, a simple unshielded cable (5-core) is quite suitable. For larger lengths or in EMV-critical environment, shielded cables should be used. The shielding should be connected to COM (reference electrode).

In long connection lines, the electrode input may change due to line capacitance. This can be adjusted through potentiometers. If necessary, the adjustment should be checked again after any modification in line length.

5.1.3 Operating voltage

12V/24V-AC/DC model: The operating voltage is connected at the terminals "SUPPLY VOLTAGE". The rating of nominal voltage is mentioned on the PCB and also on the relay and must be maintained as per specifications on the data sheet in order to ensure an error free functioning. A too high operating voltage can lead to damage of the device. Extremely low or unstable operating voltage leads to malfunctioning.

The device has a rectifier bridge after the input supply connection. Hence polarity of input voltage is arbitrary. However, if several devices are connected to the same voltage supply, the connections should be done with same polarity to avoid any potential difference in the medium.

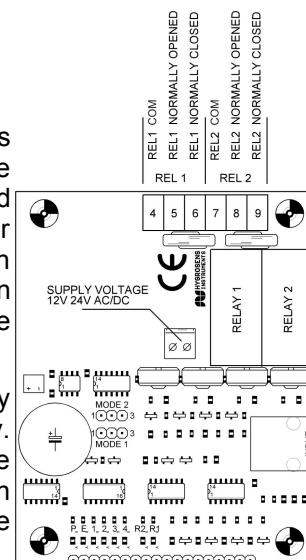

LEVEL CONTROLLER FOR CONDUCTING LIQUIDS



230V AC model:

The connection with mains power supply should be done by only trained and authorised persons. The electrical connection is done through the 9-pin plug connector as per pin configuration. The device can be operated only with 230V AC supply. The mains supply connection is protected against over-voltage through a 390V varistor.

The safety of the device against too high load current should be ensured through an external protection arrangement.

The terminal PE is not connected to the device and is only used to fix or clamp the PE wire. Its wiring is not necessary.

The container with the medium should be grounded by suitable means to protect against high voltages in case of malfunction.

5.1.4 Load circuit



The safety of load circuit, if required, should be taken care of through some external protection arrangement. (max. 5A NO contact, 2A NC contact). To switch higher currents, corresponding switching elements should be used.

The NO/NC contacts of both the relays are potential free and are terminated at the connection socket. The connection of load is done as per connector configuration. The NO contact of the relay is provided with a 390V varistor for surge suppression.

Pin	Description
1	LIVE (only 230V model)
2	NEUTRAL (only 230 V model)
3	PE (only 230V model)
4	Relay 1 common terminal
5	Relay 1 NO contact
6	Relay 1 NC contact
7	Relay 2 common terminal
8	Relay 2 NO contact
9	Relay 2 NC contact

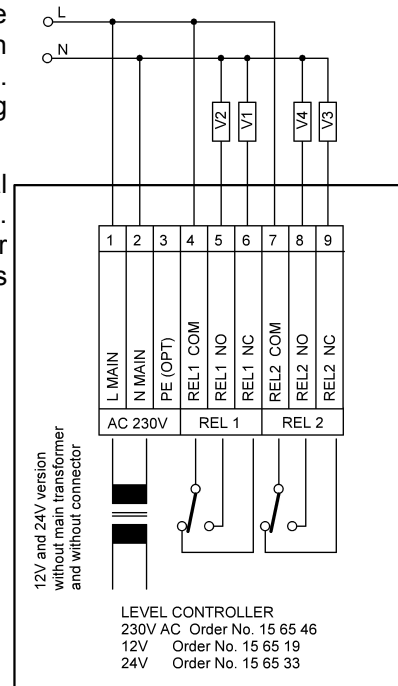

V1..V4 load circuit



5.2 Switching point adjustment

The switching point is adjusted as per conductivity of water with the preset potentiometers. In normal practice, it is good enough to set the potentiometer in the most sensitive position (right side limit). This corresponds to a switching point of approx. 12 μ S. This works for most of the applications with clean rain water or tap water. Ex factory the potentiometer is central adjusted.

If required, the sensitivity of each electrode can also be separately adjusted. By turning the potentiometer in the anti-clockwise direction, the electronics become less sensitive and this gives better results with contaminated water.

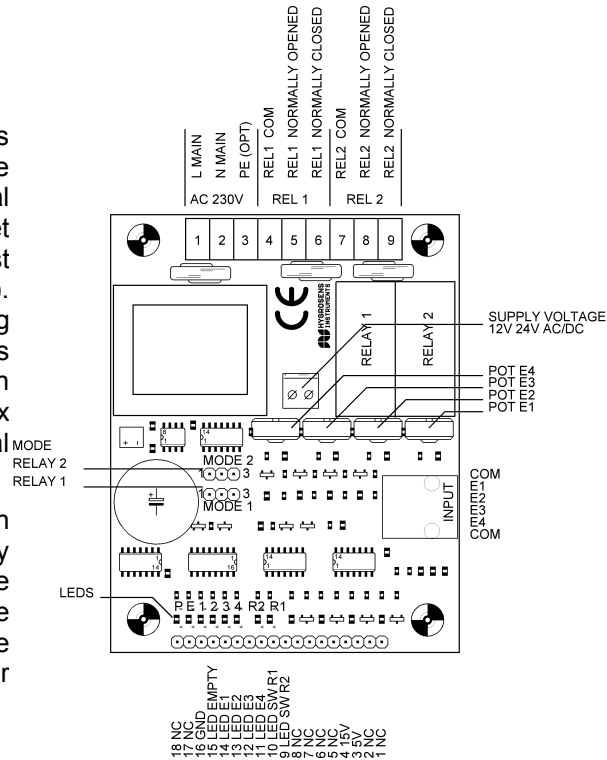

In normal practice, all potentiometers should be kept at the same position and only for very diverse conditions of electrodes with respect to the reference electrode or for different lengths of connection lines, it is practically required to separately adjust the sensitivity. After any change in cable length of the connection lines, the adjustment should be checked again.

5.3 Light emitting diodes (LEDs)

The device status is indicated by a set of 8 LEDs which are placed at the lower edge of the PCB:

LED	Function
P	Power, Operating voltage 5 V
E	Container empty, none of the electrodes are in contact
L1	Level 1 (first electrode from the container bottom)
L2	Level 2 (second electrode from the container bottom)
L3	Level 3 (third electrode from the container bottom)
L4	Level 4 (fourth electrode from the container bottom)
R2	Status Relay 2, for upper electrode pair E3 and E4
R1	Status Relay 1, for lower electrode pair E1 and E2

The LEDs are also provided on the front side for display of device status. In addition, two pushbuttons are also provided by which the relays can be manually switched ON.



5.4 Configuration of operating mode

The switching polarity of the relay (Fill/empty) can be adjusted by two jumper plugs. The jumper plug "MODE1" is meant for Relay 1 (lower level) and jumper plug "MODE2" is for Relay 2 (upper level).

If connected in position 1-2, the relay switches ON with rising level and in position 2-3, the relay switches ON with falling level.

5.5 Connection of user's own sensors



The following details are useful for persons with adequate knowledge of the associated electronics. The applicable safety regulations shall be duly followed! Connection and mounting operations shall be carried out only after switching off the voltage supply.

The following instructions help in connection of your own sensors at the input socket of electronics. However, this certainly needs necessary attention as operating voltage is present at the socket also. Sometimes, wrong connection may lead to damage of the components or result in failure of the module itself.



Touching the electronic components in switched off condition should also be avoided. Electronic components can get damaged due to electrostatic discharge process. ESD protection measures should be duly observed!

5.5.1 Pin configuration of input socket (RJ12)

Pin	Function	Colour (6 core cable)	Description
1	COM	White	Reference electrode
2	E 4	Brown	Level 4 (E4), highest
3	E 3	Green	Level 3 (E3)
4	E 2	Yellow	Level 2 (E2)
5	E 1	Grey	Level 1 (E1), lowest
6	COM	Pink	Reference electrode

Top view of contacts on the plug!

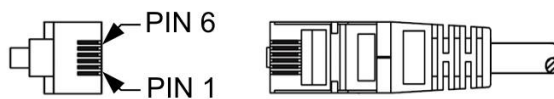

5.6 Construction of sensor

The sensor can be constructed in various ways:

- ▶ In plastic containers, the electrodes can be fitted in pairs on the container wall. Each pair always consists of a reference electrode and a sensing electrode, which are placed at a distance of approx. 5-15 cm from each other. For liquids of high conductivity, just one electrode at the bottom of the container is also good enough. The reference electrodes are connected together to the terminal COM. Due to contamination deposits on the container walls with time, such constructions are probably not maintenance free. The wall area between the electrodes should be periodically cleaned.

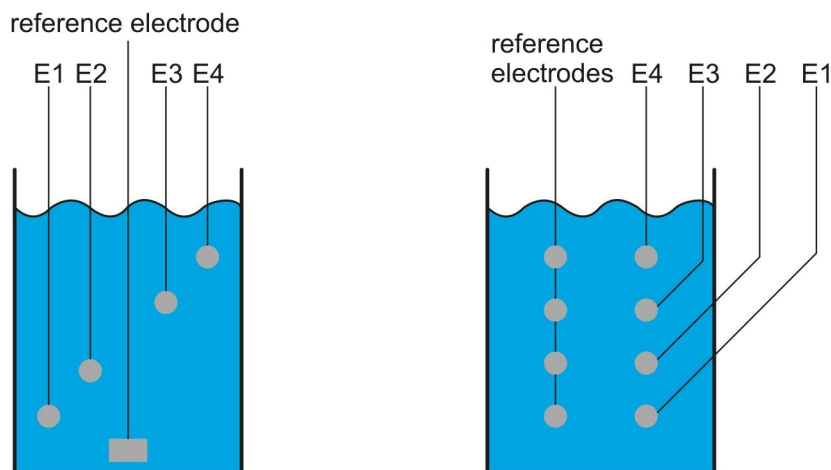

- ▶ Electrodes of stainless steel rods, hanged from top into the medium, are ideally suited for this purpose. The reference electrode is in the middle of the 4 diagonally arranged sensing electrodes which are placed in a span of approx. 1-5 cm. The spacing should be wide enough so that no drop of liquid sticks back to the rods when the level falls down. These electrodes are practically maintenance free.
- ▶ Cable probes are very simple to manufacture. For this purpose, multi-core silicon cable can be stripped at the end and joined to stainless steel balls which act as weight and also contact surface. The individual weights are lowered in the container up to the desired switching point and then the cable is tied up. For reference electrode, a bare stainless steel rope with weight can be used, which goes up to the bottom of the container. Cable sensing elements are also very reliable and practically maintenance free.
- ▶ For applications in condensate tubs and for low liquid levels, the sensing system can be constructed as a PCB which is mounted on the tank wall. Such sensing elements should also be periodically cleaned if the medium is polluted.



6 Guarantee

Hearty congratulations on the purchase of this high quality product! The quality of our products is constantly monitored within the framework of our Quality Management systems as per ISO 9001 standards. Nevertheless, if still there are any reasons for complaint, we are ready to rectify the shortcomings free of charge within the guarantee period of 24 months, if it is evident that the defect is due to some mistake on our part.

Prerequisite for the fulfilment of guarantee service is that the details of defect should be informed to us immediately and within the stipulated guarantee period.

Of course, damages due to unintended use or non-compliance of operating instructions are excluded from this guarantee coverage. Moreover, defective sensors or sensing units and also calibration service are not covered in the guarantee.

The serial number on the product should not be changed, damaged or removed.

Apart from the guarantee service, if any essential repairs are required to be carried out, the service is free. However, further services and also postage and packing expenses are chargeable.

Only repairs and replacements are covered under guarantee and other demands on the basis of liability or damage claims are not included, with the exception that general legal stipulations shall be considered valid.

6.1 Repair services

During the tenure of guarantee period, we are very much at your disposal with our service support. For any malfunctioning, you can simply send back the product to us with a short description of problems observed. Please don't forget to mention your telephone number to enable us to contact for any possible queries.

We shall inform you about the likely amount of repair charges before taking up the repair activity. The cost estimate is provided free. Postage and packing expenses for return are charged but only up to the extent of costs incurred by us.

Service address:

HYGROSENS INSTRUMENTS GmbH
- Servicewerkstatt -
Maybachstr. 2
79843 Löffingen, Germany

Telefon **0 76 54 / 80 89 69-0**
Telefax**0 76 54 / 80 89 69-9**

Email info@hygrosens.com

Internet www.hygrosens.com

LEVEL CONTROLLER FOR CONDUCTING LIQUIDS



79843 Löffingen, Germany

The technical information in this document has been checked with adequate care at our end and is intended to inform about the product and its applications. The descriptions are not to be understood as assurance of the defined characteristics of the product and should be checked by the user for the intended application. Any possible industrial third party patent rights are to be considered.

Issued March 2008 - This documentation supersedes all previous editions.

© Copyright 2008 HYGROSENS INSTRUMENTS GmbH. All rights reserved.