



Think Automation and beyond...



# LED Illumination Units



IDEC CORPORATION

Lineup	Shape	Application Examples	Illumination Color K: Color Temperature (typ.) nm: Dominant Wavelength (typ.)	Reference Illumination (typ.)	Size L x W x H mm	Illumination Surface	Rated Voltage	Power Consumption	Page
Robust and resistant housing. Can be used in environments subject to water, dust, and oil.  <b>LF1D</b> (Box) <b>LF2D</b> (Flange)  Degree of Protection: IP67f/IP67/IP69K*  * LF1D only	Slim	The optimal light distribution can be achieved by combining the lenses of different distribution angle.  · Machine tools · Food processing machines · Test equipment	White (5,700K)	Clear Surface: 1,100 lx (directly below at 1.0m) (4,400 lx directly below at 50cm, calculation value)  Diffused surface: 1,000 lx (directly below at 1.0m) (4,000 lx directly below at 50cm, calculation value)	· LF1D-E 350 x 49.8 x 29.8 · LF2D-E 389 x 80 x 33.7	Reinforced glass (Note 1) (clear/diffused)  Polycarbonate (Note 2) (clear/diffused)	24V DC	Slim: 9W	6
	Wide							Wide: 12.5W	
Wide-angle and high- illuminance model.  <b>LF1D-*H</b> (Box) <b>LF2D-*H</b> (Flange)  Degree of Protection: IP67f/IP67/IP69K*  * LF1D only	Slim	· Machine tools · Food processing machines · Automatic manufacturing machines · Printing machines · Production system · Test equipment	White (5,700K)	Slim: 1,450 lx (directly below at 1.0m)  Wide: 1,200 lx (directly below at 1.0m)	· LF1D-EH 350 x 49.8 x 29.8 · LF2D-EH 389 x 80 x 33.7 · LF1D-FH 270 x 74.7 x 25.9 · LF2D-FH 308 x 105 x 29.7	Reinforced glass (Note 1) Polycarbonate (Note 2)	24V DC	Slim: 11W	10
	Wide							Wide: 12.5W	
<b>LF1D-C</b> (Mini)  Degree of Protection: IP67f/IP67/IP69K			White (5,700K)	180 lx (directly below at 1.0m)	100 x 50 x 25	Reinforced glass	24V DC	4.6W	10
<b>LF1D-H</b> (long)  Degree of Protection: IP67f/IP67/IP69K		· Machine tools · Food processing machines · Automatic manufacturing machines · Printing machines · Production system · Test equipment	Neutral White (4,700K)	560 lx (directly below at 1.0m)	365 x 84 x 24.8	Reinforced glass	24V DC	18.4W	10
<b>LF1D-J</b> (long)  Degree of Protection: IP67f/IP67/IP69K			Neutral White (4,700K)	840 lx (directly below at 1.0m)	510 x 84 x 24.8	Reinforced glass	24V DC	27.6W	10

Note 1: Reinforced glass is resistant against oil.

Note 2: Polycarbonate is suitable for food processing machine.

# LED Illumination Unit Selection

Lineup	Shape	Application Examples	Illumination Color K: Color Temperature (typ.) nm: Dominant Wavelength (typ.)	Reference Illumination (typ.)	Size L x W x H mm	Illumination Surface	Rated Voltage	Power Consumption	Page
<b>LF2B</b> Universal input (100 to 240VAC) and 12/24V DC. Compact and slim design. Degree of Protection: IP65		<ul style="list-style-type: none"> <li>Various machines and systems</li> <li>Control panel</li> <li>Plant</li> <li>Solar power equipment</li> </ul>	White (5,500K)	Clear Cover · LF2B-B: 230 lx · LF2B-C: 425 lx · LF2B-D: 710 lx · LF2B-E: 930 lx · LF2B-F: 1,160 lx	· LF2B-B 210 x 40 x 29 · LF2B-C 330 x 40 x 29 · LF2B-D 580 x 40 x 29 · LF2B-E 830 x 40 x 29 · LF2B-F 1,080 x 40 x 29	Polycarbonate	12/24V DC	12/24V DC LF2B-B: 2.6W LF2B-C: 4.9W LF2B-D: 10.6W 100 to 240V AC LF2B-B: 3.8W LF2B-C: 7.5W LF2B-D: 9.2W LF2B-E: 14.3W LF2B-F: 21.8W	16
							100 to 240V AC		
<b>LF1B-N</b> Thin and slim styles fit into compact spaces. IP65 (waterproof, dustproof). 6 different lengths and 6 distinct colors. Degree of Protection: IP65		<ul style="list-style-type: none"> <li>Machine tool</li> <li>Plant equipment</li> <li>Test equipment</li> <li>Control panel</li> </ul>	White (5,500K)	LF1B-NA: 90 lx LF1B-NF: 935 lx (directly below at 50cm)	· LF1B-NA 134 x 27.5 x 16 · LF1B-NB 210 x 27.5 x 16 · LF1B-NC 330 x 27.5 x 16 · LF1B-ND 580 x 27.5 x 16 · LF1B-NE 830 x 27.5 x 16 · LF1B-NF 1,080 x 27.5 x 16	Clear cover (polycarbonate)	24V DC	White-Warm white -Blue LF1B-NA: 1.5W LF1B-NB: 2.9W LF1B-NC: 4.4W LF1B-ND: 8.7W LF1B-NE: 13.0W LF1B-NF: 17.3W Yellow-Red-Green LF1B-NA: 1.0W LF1B-NB: 2.0W LF1B-NC: 2.9W LF1B-ND: 5.8W LF1B-NE: 8.7W LF1B-NF: 11.6W	18
		<ul style="list-style-type: none"> <li>Food processing machines</li> <li>Cosmetic plant</li> <li>Chemical plant</li> <li>Show cases</li> </ul>	Warm white (2,900K)	LF1B-NA: 60 lx LF1B-NF: 620 lx (directly below at 50cm)					
		<ul style="list-style-type: none"> <li>Semiconductor manufacturing equipment</li> <li>IC foundry</li> </ul>	Yellow (590nm)	LF1B-NA: 20 lx LF1B-NF: 180 lx (directly below at 50cm)					
		<ul style="list-style-type: none"> <li>Photosensitive material</li> <li>Semiconductor manufacturing equipment</li> <li>Darkroom experiment</li> </ul>	Red (620nm)						
		<ul style="list-style-type: none"> <li>Advertising Display</li> <li>Light ornaments</li> </ul>	Blue (455nm)	LF1B-NA: 10 lx LF1B-NF: 80 lx (directly below at 50cm)					
			Green (525nm)	LF1B-NA: 30 lx LF1B-NF: 300 lx (directly below at 50cm)					
<b>LF1A</b> LED module and highly efficient heat dissipation technology achieved slim design. Degree of Protection: IP40		<ul style="list-style-type: none"> <li>Control panel</li> <li>Plant equipment</li> <li>Machine tool</li> <li>Test equipment</li> </ul>	White (5,500K)	LF1A-A1: 190 lx LF1A-B1: 380 lx LF1A-D1: 760 lx (directly below at 50cm)	· LF1A-A1 120 x 55 x 22 · LF1A-B1 180 x 55 x 22 · LF1A-D1 300 x 55 x 22	Clear PMMA	24V DC	White-Warm White LF1A-A1: 1.8W LF1A-B1: 3.6W LF1A-D1: 7.2W Yellow-Red LF1A-A1: 2.2W LF1A-B1: 4.4W LF1A-D1: 8.7W	20
		<ul style="list-style-type: none"> <li>Food processing machine</li> <li>Cosmetic plant</li> <li>Chemical plant</li> </ul>	Warm white (2,800K)						
		<ul style="list-style-type: none"> <li>Semiconductor manufacturing equipment</li> <li>IC foundry</li> </ul>	Yellow (590nm)						
		<ul style="list-style-type: none"> <li>Semiconductor manufacturing equipment</li> <li>Photographic laboratory</li> <li>Darkroom experiment</li> </ul>	Red (625nm)						
Resistant against dust and water. No-lens, condensing lens, and dual lens available. <b>LF1E</b> Degree of Protection: IP54		Freezer and refrigerated display case	White (5,000K)	Condensing Lens White LF1E-A: 1,800 lx LF1E-B: 1,950 lx LF1E-C: 2,000 lx LF1E-D: 2,000 lx LF1E-E: 2,000 lx (directly below at 30cm)	LF1E-A: 292 x 36 x 18.8 LF1E-B: 550 x 36 x 18.8 LF1E-C: 808 x 36 x 18.8 LF1E-D: 1,066 x 36 x 18.8 LF1E-E: 1,450 x 36 x 18.8	Clear cover (polycarbonate)	24V DC	LF1E-A: 4.2W LF1E-B: 8.4W LF1E-C: 12.6W LF1E-D: 16.8W LF1E-E: 22.8W	22
			Warm white (3,000K)						
Can be used in hazardous area of Zone 1 and 2. <b>EF1A</b> Degree of Protection: IP67		<ul style="list-style-type: none"> <li>Product Inspection</li> <li>Printing factory</li> <li>Gas station</li> <li>Chemical complex control panel</li> </ul>	White (5,700K)	Clear glass surface: 1,100 lx (condensing light) 205 lx (diffused light) Translucent glass: 450 lx (condensing light) 175 lx (diffused light)	· Direct mounting 277 x 104 x 82 · With angle adjustable mounting bracket 310.2 x 117.4 x 126.7 · With mounting bracket 310.2 x 104.0 x 99.4	Reinforced glass	100 to 240V AC	19W	25
24V DC	16W								

Note 1: Reinforced glass is resistant against oil.  
 Note 2: Polycarbonate is suitable for food processing machine.

# LUMIFA™ LF1D/LF2D LED Illumination Units

**Brightest in its class, excellent power savings. Optimal optical design achieves high brightness at both the center and periphery. IP67F degree of protection.**

- LED provides energy-savings, long-life, space-saving and no-maintenance advantages.
- Illumination surface variety—reinforced glass or polycarbonate, both in clear or diffused type.
- IP67F degree of protection (polycarbonate: IP67)
- IP69K degree of protection (LF1D)
- Robust housing of aluminum diecast and stainless steel.
- Thin and slim profiles allow installation in space-limited areas.
- Even low profile is available with the sleek design of LF2D. Resistant to dust build up on the surface.

### Application examples

Machine tools, food processing equipment, automatic manufacturing machines, printing machines, production system, test equipment, refrigeration and freezers.



### LF1D (Illumination color: white)

Style		Slim (LF1D-E)		Wide (LF1D-F)	
Shape					
LED Arrangement		10 LEDs x 1 row		7 LEDs x 2 rows	
Optional Accessories		Illumination Surface		Illumination Surface	
Cable Gland LF9Z-A11	Cable LF9Z-C05	Clear Reinforced Glass	Clear Polycarbonate	Clear Reinforced Glass	Clear Polycarbonate
Without (Cable gland hole on the side of LF1D)	—	LF1D-E2F-2W	LF1D-E3G-2W	LF1D-F2F-2W	LF1D-F3G-2W
	With	LF1D-E2F-2W-101	LF1D-E3G-2W-101	LF1D-F2F-2W-101	LF1D-F3G-2W-101
Without (Cable gland hole on the back of LF1D)	—	LF1D-E2F-2W-200	LF1D-E3G-2W-200	LF1D-F2F-2W-200	LF1D-F3G-2W-200
	With	LF1D-E2F-2W-201	LF1D-E3G-2W-201	LF1D-F2F-2W-201	LF1D-F3G-2W-201
With (Side)	—	LF1D-E2F-2W-300	LF1D-E3G-2W-300	LF1D-F2F-2W-300	LF1D-F3G-2W-300
	With	LF1D-E2F-2W-301	LF1D-E3G-2W-301	LF1D-F2F-2W-301	LF1D-F3G-2W-301
	With	LF1D-E2F-2W-350	LF1D-E3G-2W-350	LF1D-F2F-2W-350	LF1D-F3G-2W-350
With (Back)	—	LF1D-E2F-2W-400	LF1D-E3G-2W-400	LF1D-F2F-2W-400	LF1D-F3G-2W-400
	With	LF1D-E2F-2W-401	LF1D-E3G-2W-401	LF1D-F2F-2W-401	LF1D-F3G-2W-401
	With	LF1D-E2F-2W-450	LF1D-E3G-2W-450	LF1D-F2F-2W-450	LF1D-F3G-2W-450
	With	LF1D-E2F-2W-451	LF1D-E3G-2W-451	LF1D-F2F-2W-451	LF1D-F3G-2W-451

• Contact IDEC for cable gland hole other than the standard M8 size. • Use Class 2 power supply when using the LF1D as UL/c-UL listed LED illumination unit.

### LF2D (Illumination color: white)

Style		Slim (LF2D-E)		Wide (LF2D-F)	
Shape					
LED Arrangement		10 LEDs x 1 row		7 LEDs x 2 rows	
Optional Accessories		Illumination Surface		Illumination Surface	
Cable Gland LF9Z-A11	Cable LF9Z-C05	Clear Reinforced Glass	Clear Polycarbonate	Clear Reinforced Glass	Clear Polycarbonate
Without (cable gland hole on the side of LF2D)	—	LF2D-E2F-2W	LF2D-E3G-2W	LF2D-F2F-2W	LF2D-F3G-2W
Without (cable gland hole on the back of LF2D)	—	LF2D-E2F-2W-200	LF2D-E3G-2W-200	LF2D-F2F-2W-200	LF2D-F3G-2W-200
With (Side)	—	LF2D-E2F-2W-300	LF2D-E3G-2W-300	LF2D-F2F-2W-300	LF2D-F3G-2W-300
	With	LF2D-E2F-2W-A	LF2D-E3G-2W-A	LF2D-F2F-2W-A	LF2D-F3G-2W-A
With (Back)	—	LF2D-E2F-2W-400	LF2D-E3G-2W-400	LF2D-F2F-2W-400	LF2D-F3G-2W-400
	With	LF2D-E2F-2W-450	LF2D-E3G-2W-450	LF2D-F2F-2W-450	LF2D-F3G-2W-450

• Contact IDEC for cable gland hole other than the standard M8 size. • Use Class 2 power supply when using the LF2D as UL/c-UL listed LED illumination unit.

### Accessories

Accessory	Material	Part No.	Remarks	Package Quantity
Cable Gland	Brass	LF9Z-A11	M8, applicable wire size: ø3.5 to 5.5 mm	1
Mounting Bracket	Stainless Steel	LF9Z-B11	With mounting screws	2 (for right and left)
		LF9Z-B12	With mounting screws	2 (one each for right and left)
Cable	PVC	LF9Z-C05	5m	1

• See page 24 for angle adjustable mounting bracket (LF1D). • Use Class 2 power supply when using the LF2D as UL/c-UL listed LED illumination unit.

# LF1D/LF2D LED Illumination Units

### Part No. Development

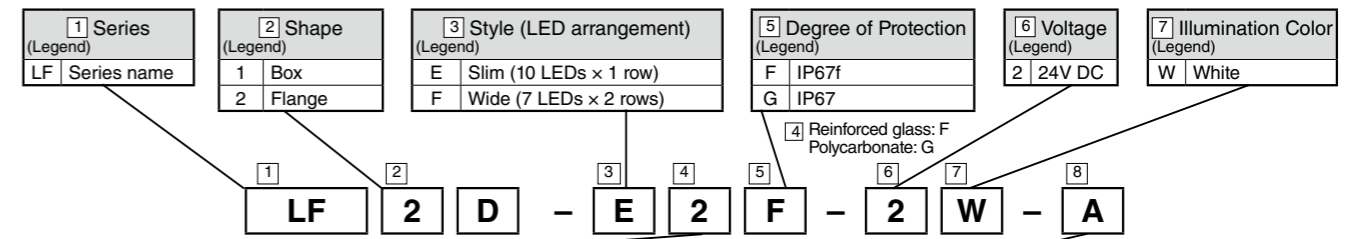

4 Illumination Surface (Legend)		8 Cable Gland (LF9Z-A11) (Legend)		8 Cable (Legend) (LF9Z-C05)		8 Mounting Bracket (Legend) (LF9Z-B11, LF9Z-B12)	
2	Clear	Reinforced glass	Blank	Without accessories. Cable gland hole on the side.			
3		Polycarbonate	A	With cable gland (standard). With cable. With mounting bracket (LF1D only)			
5	Diffused	Polycarbonate	1	Without cable gland. Cable gland hole on the side.		0	Without
9			Reinforced glass	2	Without cable gland. Cable gland hole in the back.		0
			3	With cable gland (standard) on the side.		0	Without
			4	With cable gland (standard) in the back.		5	Yes

• LF1D/LF2D: \*100\* and \*351\* are not available.  
• LF2D: \*350\* and \*1\* (with mounting bracket) are not available.

### Specifications

Model	LF1D		LF2D	
	Slim	Wide	Slim	Wide
Style	Slim	Wide	Slim	Wide
Rated Voltage	24V DC			
Voltage Range	21.6 to 26.4V DC			
Rated Power (typ.) (at rated voltage)	9W	12.5W	9W	12.5W
Insulation Resistance	1MΩ minimum (500V DC megger)			
Dielectric Strength	1000V AC 50/60Hz, 1 minute			
Vibration Resistance (damage limits)	Frequency 5 to 55 Hz, amplitude 0.5 mm			
Shock Resistance (damage limits)	1000 m/s <sup>2</sup>			
Operating Temperature	-30 to +55°C (no freezing)			
Operating Humidity	45 to 85% RH (no condensation)			
Storage Temperature	-35 to +70°C (no freezing)			
Operating Atmosphere	No corrosive gas			
Life (Note 1)	50,000 hours (The illumination duration in which the brightness maintains a minimum of 70% of the initial value at 25°C.)			
Degree of Protection (Note 2)	IP67F (reinforced glass), IP67 (polycarbonate)			
Material (Note 3)	Housing: Diecast aluminum Front cover: Stainless steel Illumination surface: Reinforced glass or polycarbonate		Housing and flange: Diecast aluminum Illumination surface: Reinforced glass or polycarbonate	
Weight (approx.)	LF1D-E**2W*: 750g LF1D-E**2W-A*: 950g	LF1D-F**2W*: 800g LF1D-F**2W-A*: 1000g	LF2D-E**2W*: 850g LF2D-E**2W-A*: 1000g	LF2D-F**2W*: 900g LF2D-F**2W-A*: 1050g

Note 1: LED life depends on the operating environment.  
Note 2: Waterproof or oil-proof characteristics specified by IEC 60529 and JEM1030.  
For illumination units without accessories, use a cable gland and cable that satisfy IP67F or IP67 degree of protection.  
Note 3: The reinforced glass and polycarbonate illumination surfaces have the same appearance, but have different degrees of protection (IP67F or IP67).

### LED Optical Specifications

Model	LF1D				LF2D			
	Slim		Wide		Slim		Wide	
Illumination Surface	Clear	Diffused	Clear	Diffused	Clear	Diffused	Clear	Diffused
Illumination Color	White							
Color Temperature (typ.)	5700K							
Total Luminous Flux (typ.)	600 lm		840 lm		600 lm		840 lm	
Reference Illuminance (typ.) at 1.0m directly below	1100 lx	1000 lx	1100 lx	1000 lx	1100 lx	1000 lx	1100 lx	1000 lx

• LED modules and illumination units may vary in illumination color and illuminance.

### Illuminance Distribution (LF1D/LF2D) at 1.0m

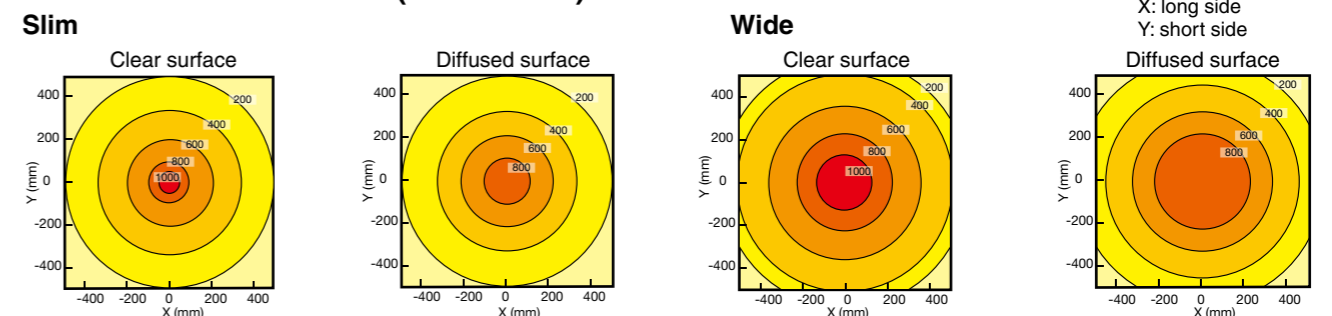

### Terminal Block Wiring

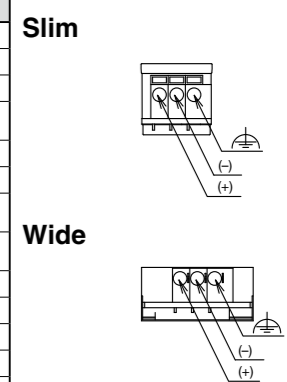

Applicable ferrules: 0.25 to 0.75 mm<sup>2</sup>  
Recommended source:  
Phoenix Contact:  
AI 0,25-12 BU, AI 0,34-12 TQ,  
AI 0,5-12 WH, AI 0,75-12 GY

### Internal Circuit

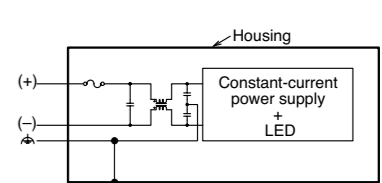

# LF1D/LF2D LED Illumination Units

## Dimensions

LF1D-E (Slim, 10 LEDs × 1 row)

All dimensions in mm.

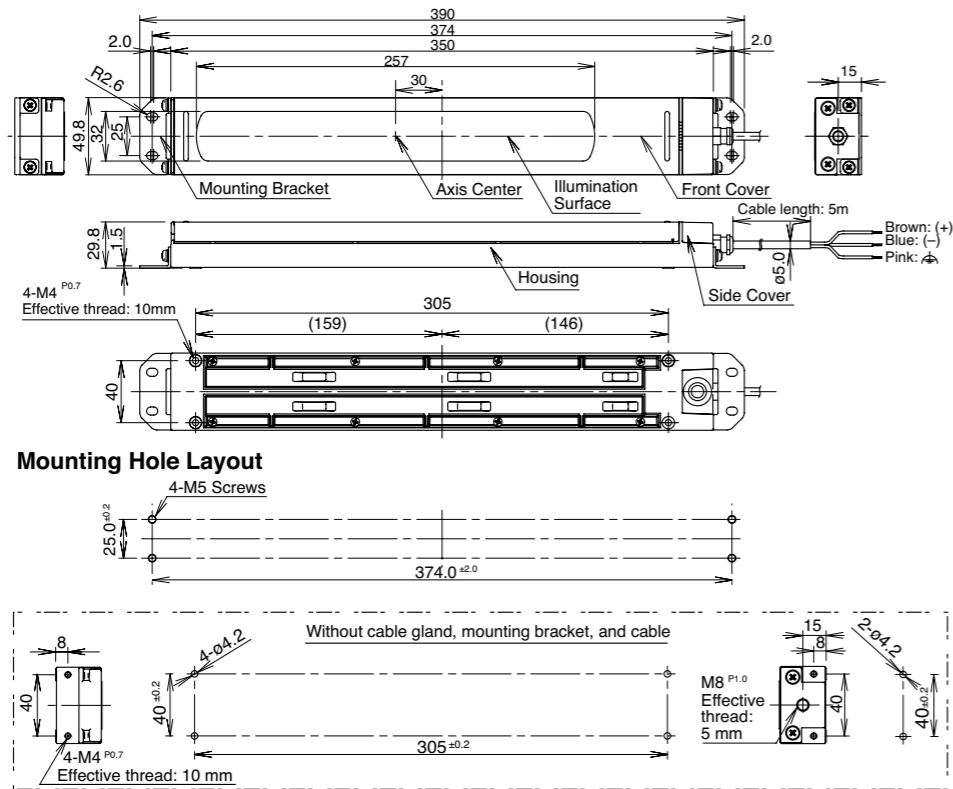

LF1D-F (Wide, 7 LEDs × 2 rows)

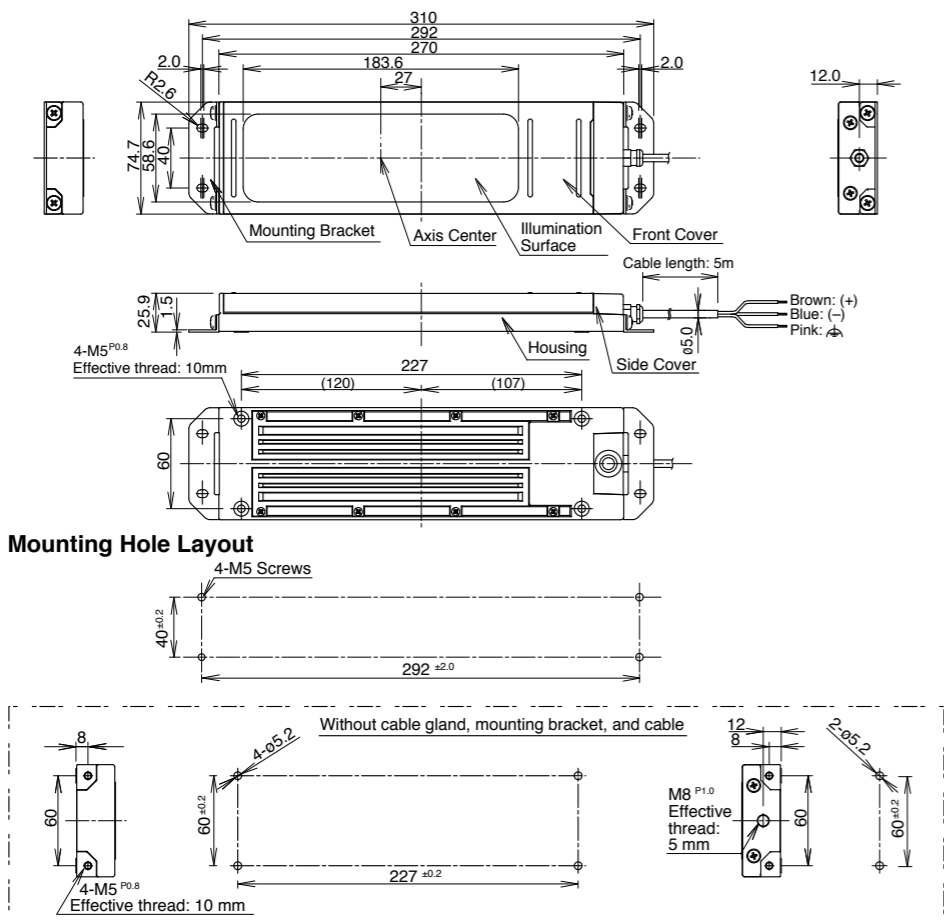

# LF1D/LF2D LED Illumination Units

## Dimensions

LF2D-E (Slim, 10 LEDs × 1 row)

All dimensions in mm.

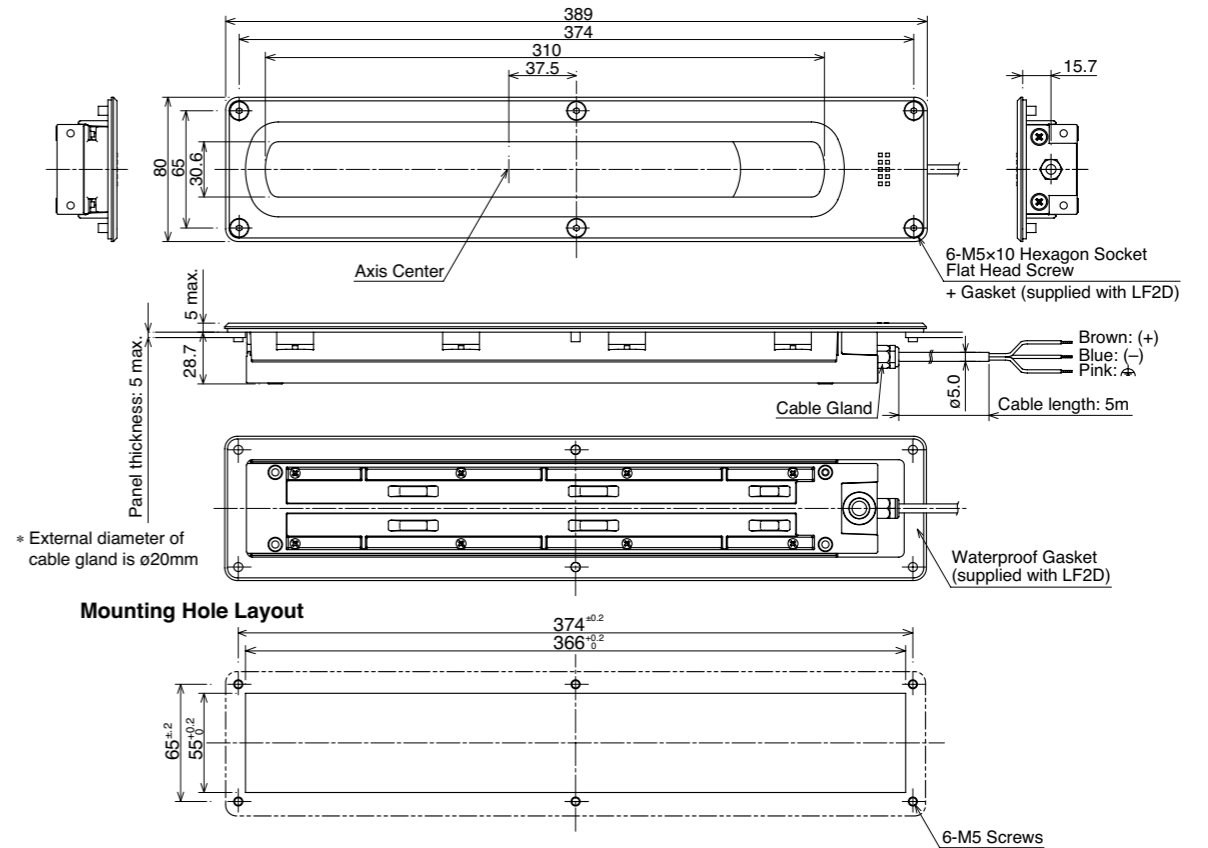

LF2D-F (Wide, 7 LEDs × 2 rows)

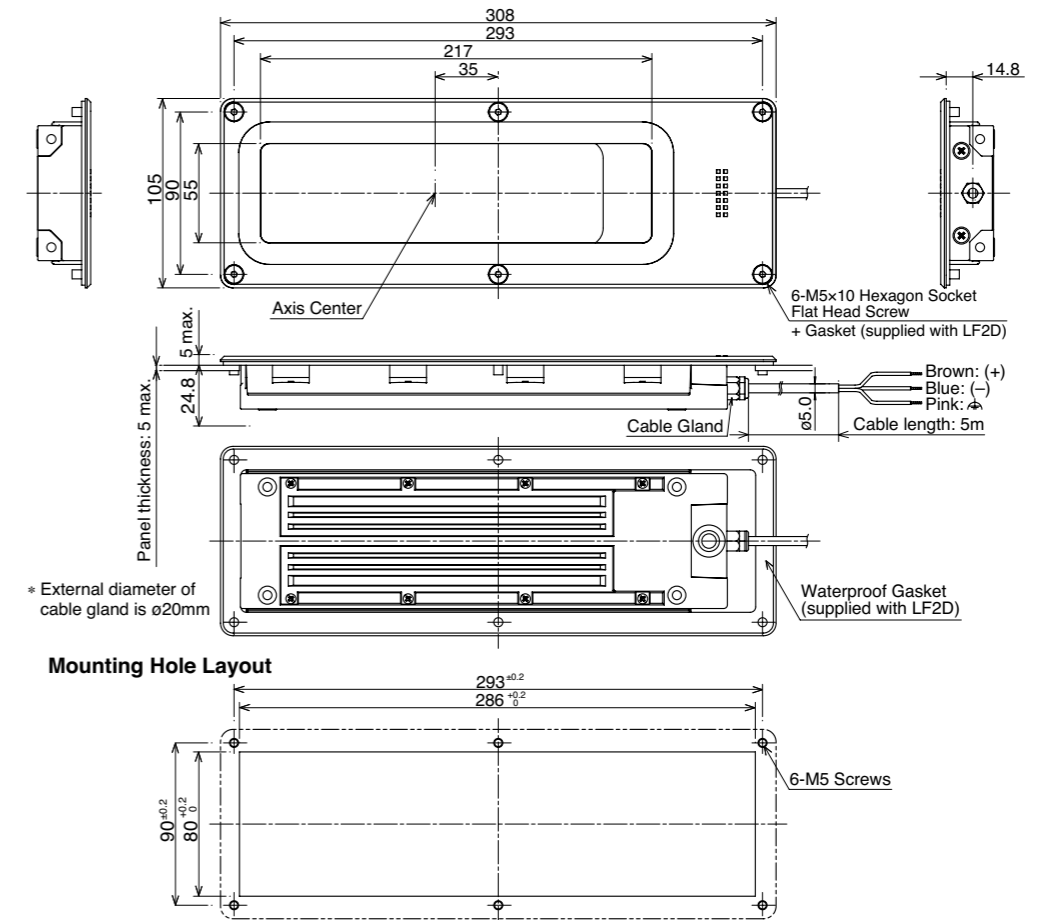

# LUMIFA™ LF1D/LF2D LED Illumination Units

Water, dust, oil-proof LED illumination units in slim and compact housings.  
A variety of sizes and light distribution angles for various sizes and types of machine.

- Water, dust, oil-proof IP67, IP67F (reinforced glass illumination surface), IP69K (LF1D) degree of protection.
- Robust housing of aluminum diecast, stainless steel, and reinforced glass.

## LF1D-C (mini)

- Compact profile of 100 × 50 × 25 mm.
- No-multi shadow light illuminate the small surface scratches and irregularity of target objects, improving the processing accuracy. Wide 120° distribution angle.

## LF1D-EH / LF2D-EH / LF1D-FH / LF2D-FH (slim/wide)

- Lights the target object and the periphery in wide angle. Suitable for middle-sized machines.
- The terminal block and spring clamp connections ensure easy wiring and installation. Combination with angle adjustable mounting bracket enables installation in various applications.

## LF1D-H / LF1D-J (long)

- Two length available (365 mm and 510 mm).
- Flat, no-multi shadow light with less glare illuminates the small surface scratches and irregularity of target objects from a distance, improving the processing accuracy.
- Wide 120° distribution angle. High-power 2000/3000 lm luminous flux is suitable for replacing fluorescent light.



### Application Examples

Machine tools, food processing equipment, automatic manufacturing machines, printing machines, production system, and test equipment.



## LF1D-C (mini, illumination color: white)

Cable	Length	Part No.
With (side)	3m	LF1D-C2F-2W-330
	5m	LF1D-C2F-2W-350
With (back)	3m	LF1D-C2F-2W-430
	5m	LF1D-C2F-2W-450

## LF1D-EH/FH (slim/wide, wide angle & high illuminance, shape: box, illumination color: white)

Style			Slim (LF1D-EH)		Wide (LF1D-FH)	
Optional Accessories			Illumination Surface			
Cable Gland LF9Z-A11	Cable (5m) LF9Z-C05	Mounting Bracket LF9Z-B11, -B12	Reinforced Glass	Polycarbonate	Reinforced Glass	Polycarbonate
Without (cable gland hole on the side)	—	—	LF1D-EH2F-2W	LF1D-EH3G-2W	LF1D-FH2F-2W	LF1D-FH3G-2W
	—	With	LF1D-EH2F-2W-101	LF1D-EH3G-2W-101	LF1D-FH2F-2W-101	LF1D-FH3G-2W-101
Without (cable gland hole on the back)	—	—	LF1D-EH2F-2W-200	LF1D-EH3G-2W-200	LF1D-FH2F-2W-200	LF1D-FH3G-2W-200
	—	With	LF1D-EH2F-2W-201	LF1D-EH3G-2W-201	LF1D-FH2F-2W-201	LF1D-FH3G-2W-201
With (side)	—	—	LF1D-EH2F-2W-300	LF1D-EH3G-2W-300	LF1D-FH2F-2W-300	LF1D-FH3G-2W-300
		With	LF1D-EH2F-2W-301	LF1D-EH3G-2W-301	LF1D-FH2F-2W-301	LF1D-FH3G-2W-301
	With	—	LF1D-EH2F-2W-350	LF1D-EH3G-2W-350	LF1D-FH2F-2W-350	LF1D-FH3G-2W-350
		With	LF1D-EH2F-2W-A	LF1D-EH3G-2W-A	LF1D-FH2F-2W-A	LF1D-FH3G-2W-A
With (back)	—	—	LF1D-EH2F-2W-400	LF1D-EH3G-2W-400	LF1D-FH2F-2W-400	LF1D-FH3G-2W-400
		With	LF1D-EH2F-2W-401	LF1D-EH3G-2W-401	LF1D-FH2F-2W-401	LF1D-FH3G-2W-401
	With	—	LF1D-EH2F-2W-450	LF1D-EH3G-2W-450	LF1D-FH2F-2W-450	LF1D-FH3G-2W-450
		With	LF1D-EH2F-2W-451	LF1D-EH3G-2W-451	LF1D-FH2F-2W-451	LF1D-FH3G-2W-451

Package Quantity: 1

## LF2D-EH/FH (slim/wide, wide angle & high illuminance, shape: flange, illumination color: white)

Style			Slim (LF2D-EH)		Wide (LF2D-FH)	
Optional Accessories			Illumination Surface			
Cable Gland LF9Z-A11	Cable (5m) LF9Z-C05	Mounting Bracket LF9Z-B11, -B12	Reinforced Glass	Polycarbonate	Reinforced Glass	Polycarbonate
Without (cable gland hole on the side)	—	—	LF2D-EH2F-2W	LF2D-EH3G-2W	LF2D-FH2F-2W	LF2D-FH3G-2W
	—	With	LF2D-EH2F-2W-101	LF2D-EH3G-2W-101	LF2D-FH2F-2W-101	LF2D-FH3G-2W-101
Without (cable gland hole on the back)	—	—	LF2D-EH2F-2W-200	LF2D-EH3G-2W-200	LF2D-FH2F-2W-200	LF2D-FH3G-2W-200
	—	With	LF2D-EH2F-2W-201	LF2D-EH3G-2W-201	LF2D-FH2F-2W-201	LF2D-FH3G-2W-201
With (side)	With	—	LF2D-EH2F-2W-300	LF2D-EH3G-2W-300	LF2D-FH2F-2W-300	LF2D-FH3G-2W-300
		With	LF2D-EH2F-2W-A	LF2D-EH3G-2W-A	LF2D-FH2F-2W-A	LF2D-FH3G-2W-A
With (back)	With	—	LF2D-EH2F-2W-400	LF2D-EH3G-2W-400	LF2D-FH2F-2W-400	LF2D-FH3G-2W-400
		With	LF2D-EH2F-2W-450	LF2D-EH3G-2W-450	LF2D-FH2F-2W-450	LF2D-FH3G-2W-450

Package Quantity: 1

# LUMIFA™ LF1D/LF2D LED Illumination Units

## LF1D-EH/FH, LF2D-EH/FH Accessories (slim/wide)

Accessory	Material	Part No.	Remarks	Package Quantity
Cable Gland	Brass	LF9Z-A11	M8, applicable wire size: 3.5 to 5.5	1
Mounting Bracket	Stainless Steel	LF9Z-B11	With mounting screws	2 (for right and left)
		LF9Z-B12		
Angle Adjustable Mounting Bracket	Stainless Steel	LF9Z-1MDE1		
		LF9Z-1MDF1		
Cable	PVC	LF9Z-C05	5 m	1

## LF1D-H (long model 365 mm, illumination color: neutral white)

Cable	Length	Part No.
Side	5m	LF1D-H2F-2N-350
	1.5m + M12 connector	LF1D-H2F-2N-3B0
Back	5m	LF1D-H2F-2N-450
	1.5m + M12 connector	LF1D-H2F-2N-4B0

## LF1D-J (long model 510 mm, illumination color: neutral white)

Cable	Length	Part No.
Side	5m	LF1D-J2F-2N-350
	1.5m + M12 connector	LF1D-J2F-2N-3B0
Back	5m	LF1D-J2F-2N-450
	1.5m + M12 connector	LF1D-J2F-2N-4B0

## Part No. Development

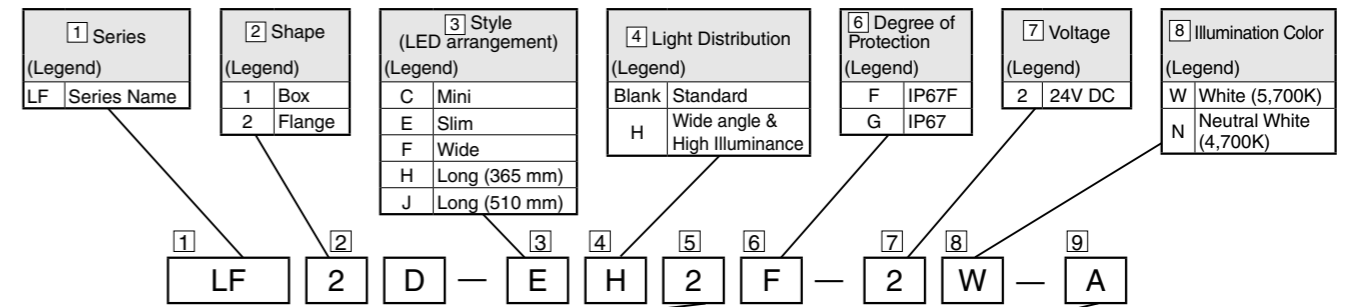

[5] Illumination Surface (Legend)	[9] Cable Gland (LF9Z-A11) (Legend)	[9] Cable (LF9Z-C05) (Legend)	[9] Mounting Bracket (LF9Z-B11, LF9Z-B12) (Legend)
2 Clear	Blank Without accessories. Cable gland hole on the side.	0 Without	0 Without
3 Reinforced glass	1 Without cable gland. Cable gland hole on the side.	3 3m cable	1 With
5 Polycarbonate	2 Without cable gland. Cable gland hole on the back.	5 5m cable	
9 Reinforced glass	3 With cable gland (standard) on the side.	B 1.5m cable + M12 connector	
	4 With cable gland (standard) on the back.	A Slim/Wide: with cable gland, With 5m cable. With mounting bracket.	

Not all combinations of part no. codes are possible. For available part nos., contact IDEC.

## Specifications

Model	LF1D-C	LF1D-E/LF2D-E	LF1D-EH/LF2D-EH	LF1D-F/LF2D-F	LF1D-FH/LF2D-FH	LF1D-H	LF1D-J
Style	Mini	Slim	Slim (wide angle & high illuminance)	Wide	Wide (wide angle & high illuminance)	Long (365 mm)	Long (510 mm)
Rated Voltage	24V DC						
Voltage Range	21.6 to 26.4V DC						
Rated Power (typ.) (at rated voltage)	4.6W	9W	11W	12.5W	12.5W	18.4W	27.6W
Insulation Resistance	100MΩ minimum (500V DC megger)						
Dielectric Strength	1,000V AC, 50/60Hz, 1 minute						
Vibration Resistance (damage limits)	Frequency 5 to 55Hz, amplitude 0.5mm						
Shock Resistance (damage limits)	1,000 m/s²						
Operating Temperature	-30 to +55°C (no freezing)						
Operating Humidity	45 to 85%RH (no condensation)						
Storage Temperature	-35 to +70°C (no freezing)						
Operating Atmosphere	No corrosive gas						
Life (Note 1)	50,000 hours (The illumination duration in which the brightness maintains a minimum of 70% of the initial value at 25°C.)						
Degree of Protection (Note 2)	IP67 (all models), IP67F (reinforced glass illumination surface), IP69K (LF1D)						
Material (Note 3)	Housing: aluminum Front cover: stainless steel Illumination surface: reinforced glass	Housing: diecast aluminum Front cover (LF1D): stainless steel Flange (LF2D): diecast aluminum Illumination surface: reinforced glass or polycarbonate			Housing: aluminum Front cover: stainless steel Illumination surface: reinforced glass		
Weight (approx.)	LF1D-C2F-2W-350: 420g	LF1D-E (H)**-2W-W: 950g LF2D-E (H)**-2W-A: 1,000g	LF1D-F (H)**-2W-A: 1,000g LF2D-F (H)**-2W-A: 1,050g	LF1D-H2F-2N-350: 1,200g	LF1D-J2F-2N-350: 1,600g		

Note 1: LED life depends on the operating environment.

Note 2: Waterproof or oil-proof characteristics specified by IEC 60529 (IP67) and DIN40050-9 (IP69K). For illumination units without accessories, use a cable gland and cable that satisfy the required degree of protection.

Note 3: The reinforced glass and polycarbonate illumination surfaces have the same appearance, but have different degrees of protection.

## LED Optical Specifications

Model	LF1D-C	LF1D-E/LF2D-E	LF1D-EH/LF2D-EH	LF1D-F/LF2D-F	LF1D-FH/LF2D-FH	LF1D-H	LF1D-J
Style	Mini	Slim	Slim (wide angle & high illuminance)	Wide	Wide (wide angle & high illuminance)	Long (365 mm)	Long (510 mm)
Illumination Color	White					Neutral White	
Color Temp. (typ.)	5,700 K					4,700 K	
Luminous Flux (typ.)	560 lm	600 lm	1,000 lm	840 lm	1,260 lm	2,000 lm	3,000 lm
Reference Illuminance (typ.) at 1.0m directly below	180 lx	1,100 lx	1,450 lx	1,100 lx	1,200 lx	560 lx	840 lx

• LED modules and illumination units may vary in illumination color and illuminance.

## Light Distribution Characteristics at 1.0 m

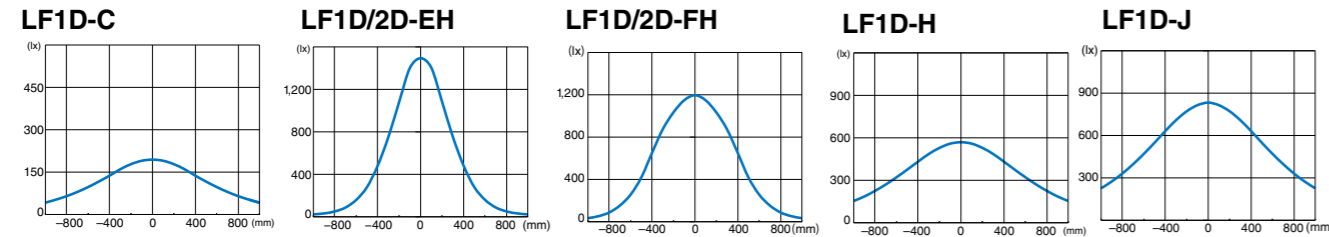

## Light Distribution Curve

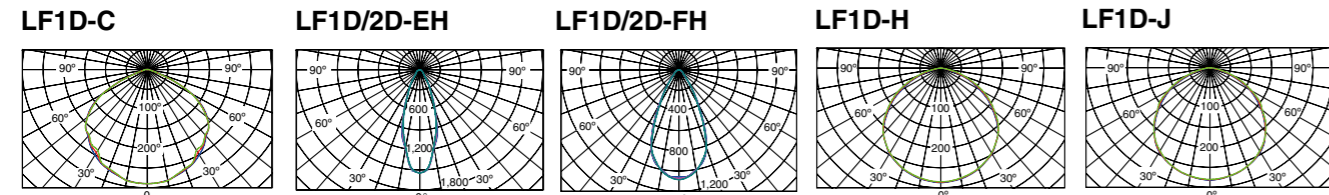

## Internal Circuit

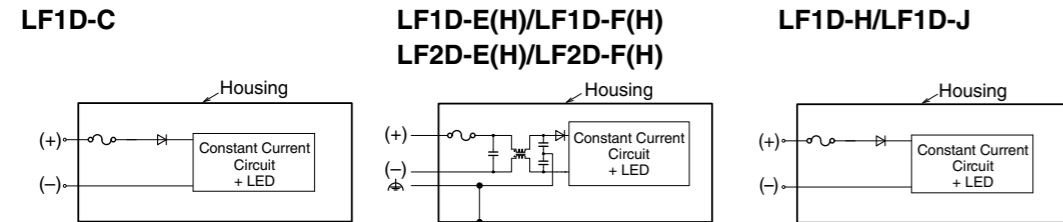

## Dimensions

### LF1D-C (Mini Model)

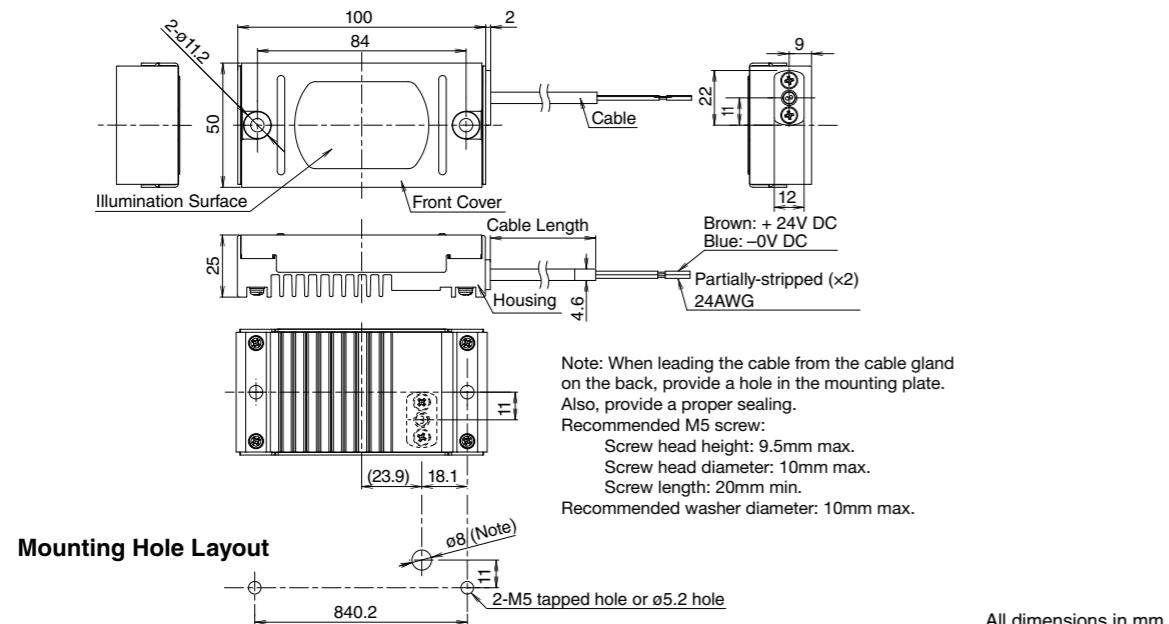

All dimensions in mm.

## LF1D-E/EH (Slim Model/Box) (10 LEDs × 1 row)

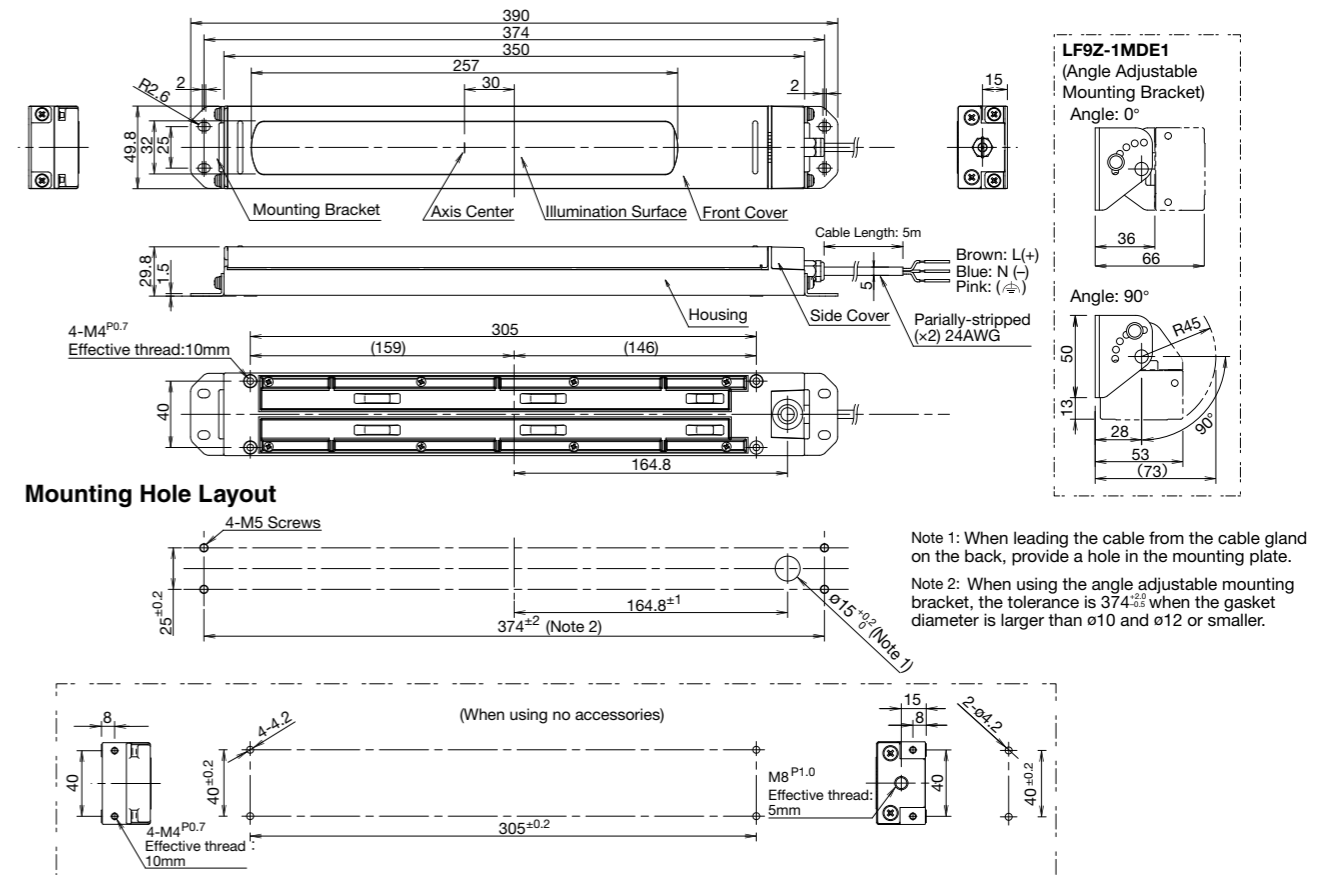

## LF2D-E/EH (Slim Model/Flange) (10 LEDs × 1 row)

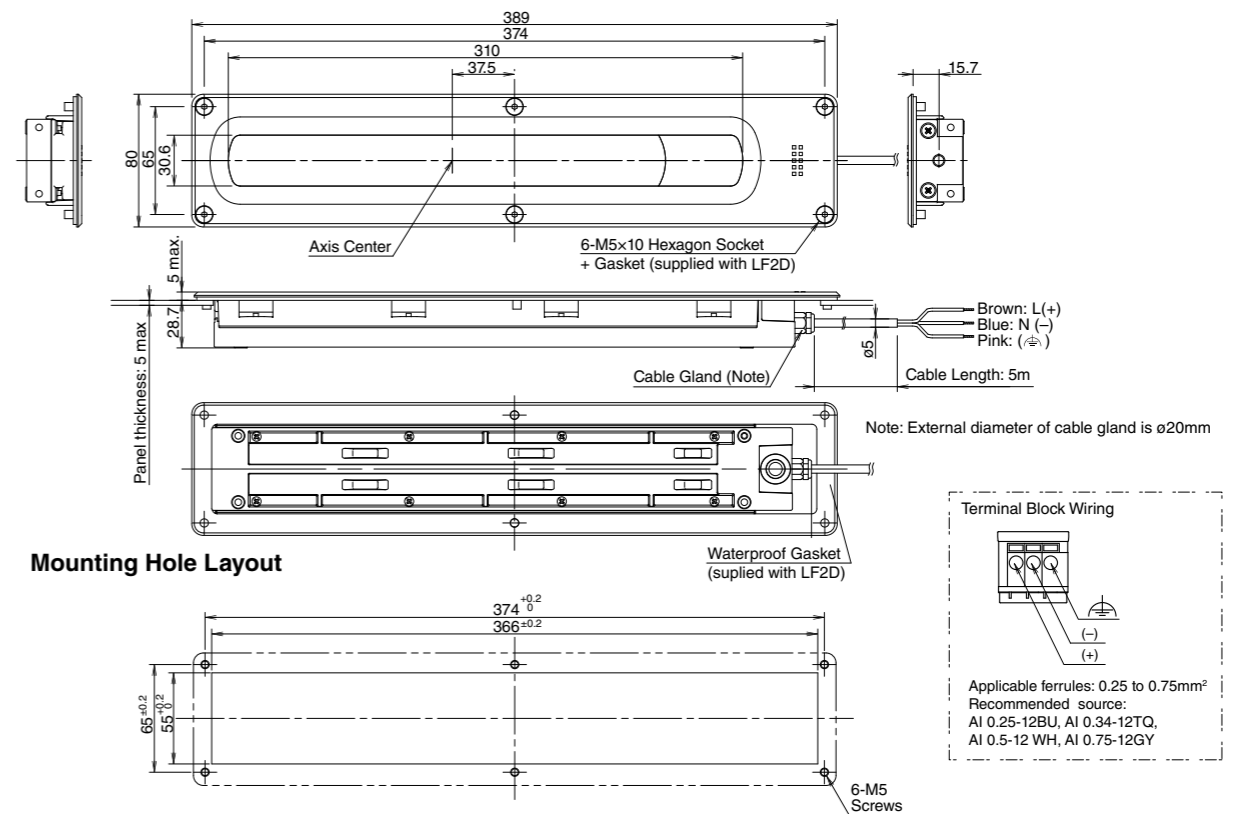

All dimensions in mm.

## LF1D-F/FH (Wide Model/Box) (7 LEDs x 2 rows)

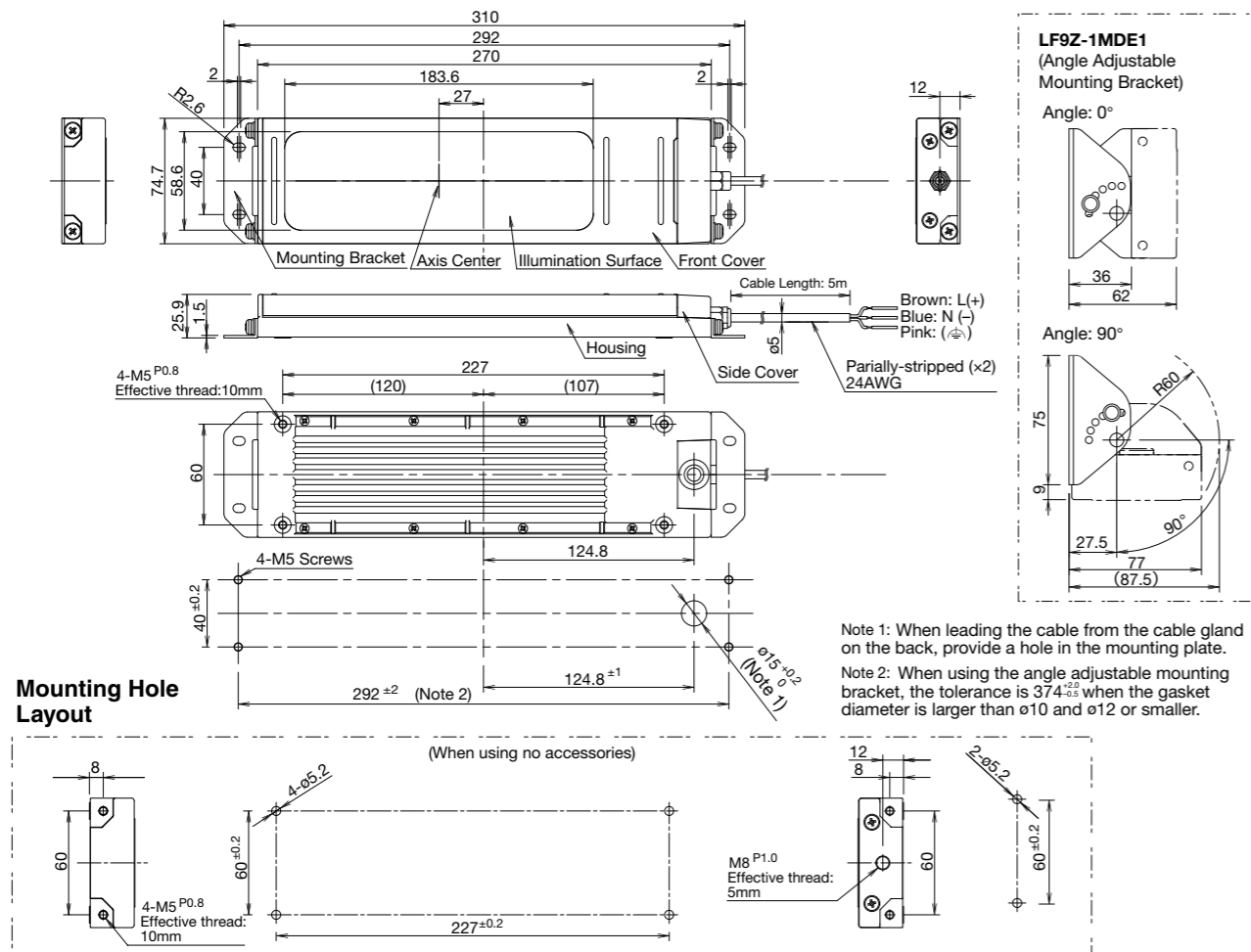

## LF2D-F/FH (Wide Model/Flange) (7 LEDs x 2 rows)

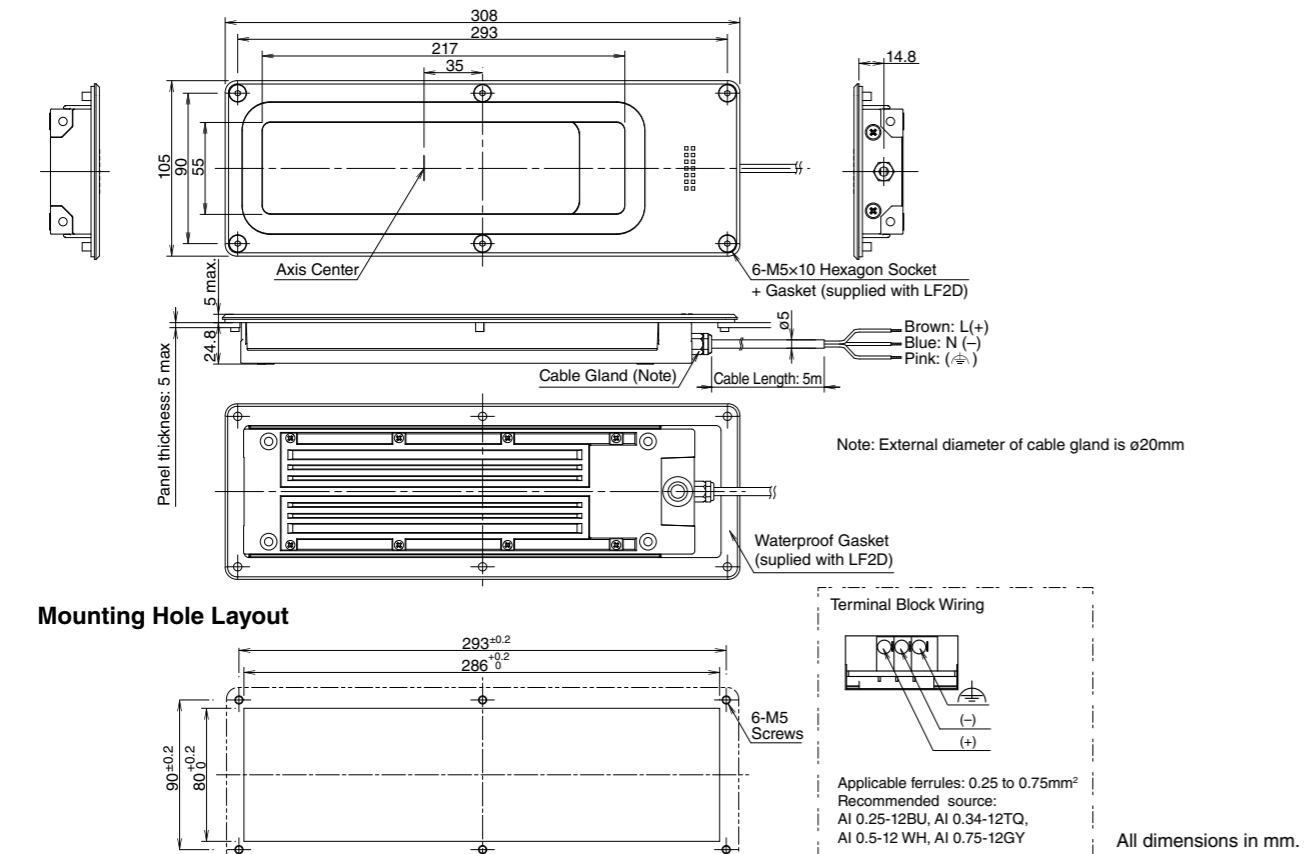

## LF1D-H (Long Model, 365 mm)

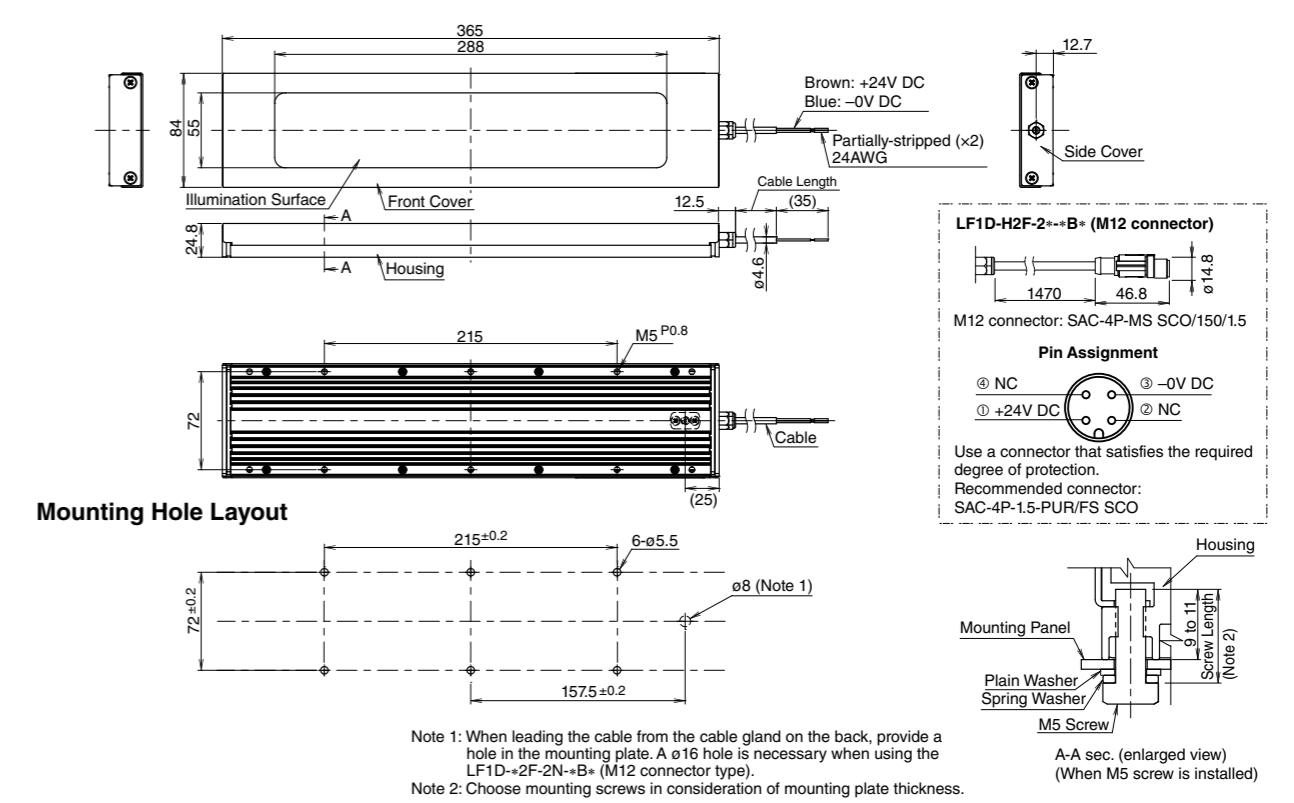

## LF1D-J (long model, 510 mm)

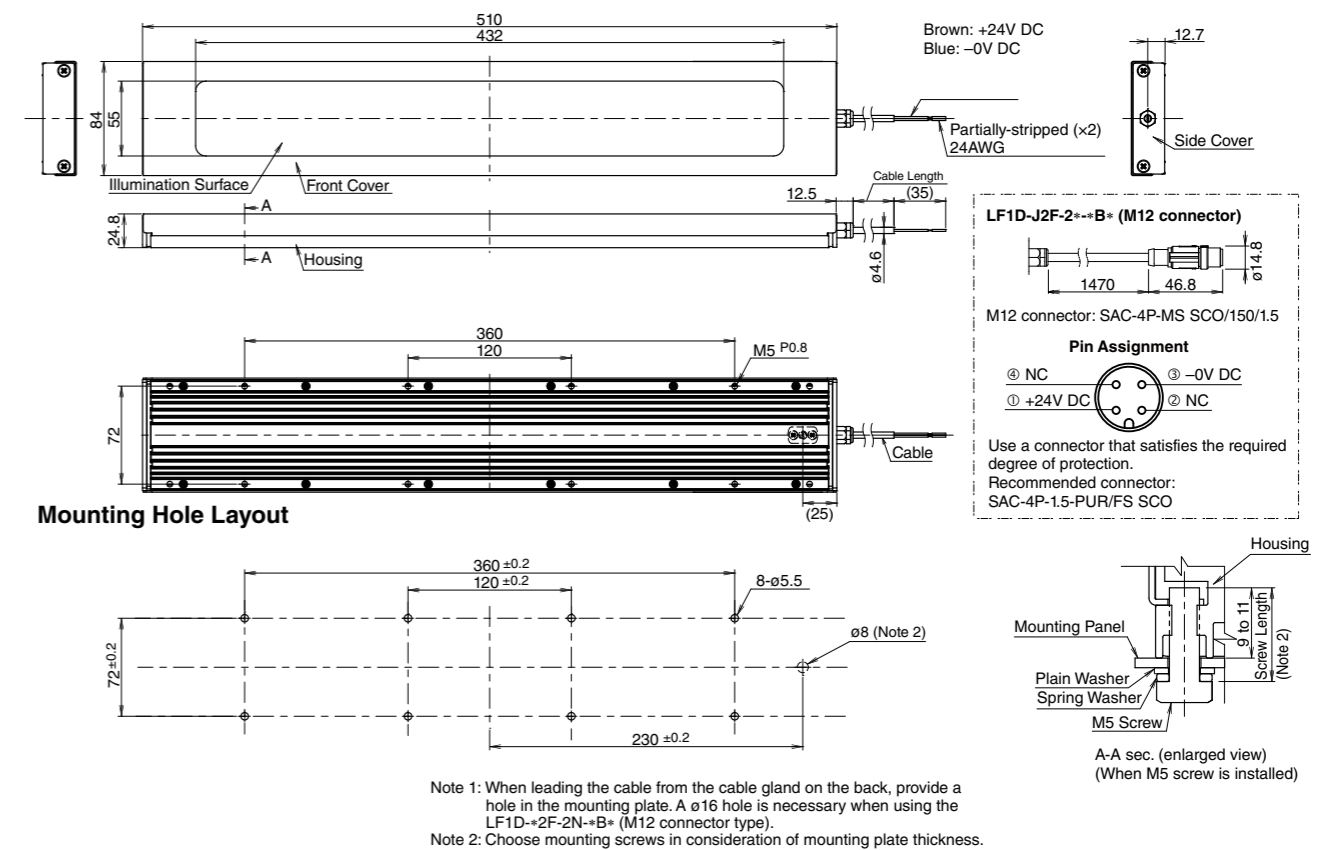

All dimensions in mm.



# LUMIFA™ LF2B LED Illumination Units

Universal input (100 to 240V AC) and 12/24V DC input models are available.  
Compact and slim design suitable for installing in various applications and also in narrow spaces. IP65 (waterproof, dustproof).

- Slim design (40mm wide, 29mm high). Can be installed in narrow spaces easily using mounting brackets.
- Five different lengths (210, 330, 580, 830, and 1,080 mm) available.
- Bright and clear white LED illuminates the target object clearly and brightly.
- Choice of two cover colors: clear and white.



Package quantity: 1



(12/24V DC model only)

Illumination Color	White			
	Clear Cover		White Cover	
Shape				
Rated Voltage	100 to 240V AC	12/24V DC	100 to 240V AC	12/24V DC
LF2B-B (210mm)	LF2B-B3P-ATHWW2-1M	LF2B-B3P-BTHWW2-1M	LF2B-B4P-ATHWW2-1M	LF2B-B4P-BTHWW2-1M
LF2B-C (330mm)	LF2B-C3P-ATHWW2-1M	LF2B-C3P-BTHWW2-1M	LF2B-C4P-ATHWW2-1M	LF2B-C4P-BTHWW2-1M
LF2B-D (580mm)	LF2B-D3P-ATHWW2-1M	LF2B-D3P-BTHWW2-1M	LF2B-D4P-ATHWW2-1M	LF2B-D4P-BTHWW2-1M
LF2B-E (830mm)	LF2B-E3P-ATHWW2-1M		LF2B-E4P-ATHWW2-1M	
LF2B-F (1,080mm)	LF2B-F3P-ATHWW2-1M		LF2B-F4P-ATHWW2-1M	

• Use Class 2 power supply when using the LF2B as UL/c-UL listed LED illumination unit (12/24V DC only).

## Part No. Development

### LF2B-C 3 P-ATHWW2-1M

**Length**  
B: 210mm  
C: 330mm  
D: 580mm  
E: 830mm  
F: 1,080mm

**Cover**  
3: Clear  
4: White

**Rated Voltage**  
A: 100 to 240V AC  
B: 12/24V DC (210, 330, and 580mm lengths only)

## Accessories

Model	Part No.	Package Quantity	Remarks
U-shaped Mounting Bracket	LF9Z-1SB21PN10	10	Supplied with the LF2B. LF2B-B, -C, and D: Two brackets are supplied. LF2B-E: Three brackets are supplied. LF2B-F: Four brackets are supplied.
L-shaped Mounting Bracket	LF9Z-1SB22PN10	10	Two brackets (for right and left) are required for alternate mounting of an LF2B.

## Internal Circuit

### 100 to 240V AC

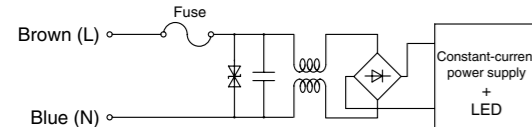

### 12/24V DC

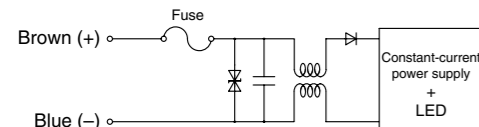

## Dimensions

### Without mounting bracket

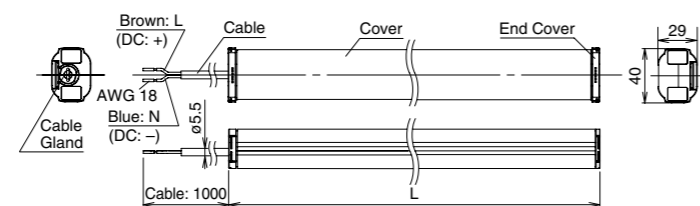

Part No.	L
LF2B-B*P-THWW2-1M	210
LF2B-C*P-THWW2-1M	330
LF2B-D*P-THWW2-1M	580
LF2B-E*P-THWW2-1M	830
LF2B-F*P-THWW2-1M	1,080

All dimensions in mm.

# LF2B LED Illumination Units

## Specifications

Model	LF2B-B (210mm)	LF2B-C (330mm)	LF2B-D (580mm)	LF2B-E (830mm)	LF2B-F (1,080mm)
Rated Voltage	100 to 240V AC, 50/60 Hz (voltage range: 90 to 264V AC) 12/24V DC (voltage range: 10.8 to 30V DC)				
Input Current (typ.) (at the rated current) (Note 1)	100 to 240V AC 12/24V DC	33 mA 215 mA	67 mA 409 mA	96 mA 880 mA	149 mA 226 mA
Power Consumption (typ.) (at the rated voltage)	100 to 240V AC 12/24V DC	3.8W 2.6W	7.5W 4.9W	9.2W 10.6W	14.3W 21.8W
Insulation Resistance	100MΩ min. (500V DC meggar)				
Dielectric Strength	100 to 240V AC 12/24V DC	2,000V AC, 1 minute (between live and dead parts) 1,000V AC, 1 minute (between live and dead parts)			
Vibration Resistance (damage limits)	Frequency: 5 to 55 Hz, Amplitude 0.17 mm Acceleration 20m/s <sup>2</sup> , 2 hours each in 3 axes				
Shock Resistance (damage limits)	300m/s <sup>2</sup> , 5 shocks each in 6 axes				
Operating Temperature	-30 to +55°C (no condensation)				
Operating Humidity	45 to 85% (no freezing)				
Storage Temperature	-35°C to +70°C (no condensation)				
Operating Atmosphere	No corrosive gas				
Life (Note 2)	40,000 hours (Ta = 25°C) (The total illumination life in which the illuminance maintains a minimum of 70% of the initial value.)				
Degree of Protection	IP65 (IEC 60529)				
Material	Cover: polycarbonate, End cover/cable gland: polyamide. Wire: PVC (AWG24x2C)				
Weight (approx.)	100 to 240V AC 12/24V DC	200g 175g	255g 235g	400g 370g	520g 645g

Note 1: 100 to 240V AC: at 100V AC, 12/24V DC: 12V DC

Note 2: LED life depends on the operating environment.

## LED Optical Specifications

Illumination Color	White									
Color Temperature	5,500K									
Model	LF2B-B (210mm)		LF2B-C (330mm)		LF2B-D (580mm)		LF2B-E (830mm)		LF2B-F (1,080mm)	
Luminous Flux (typ.)	180 lm		360 lm		720 lm		1,080 lm		1,440 lm	
Cover	Clear	White	Clear	White	Clear	White	Clear	White	Clear	White
Reference Illuminance (typ.) at 0.5m directly below	230 lx	215 lx	425 lx	390 lx	710 lx	645 lx	930 lx	835 lx	1,160 lx	1,040 lx

• LED modules and illumination units may vary in illumination colors and illuminance.

## Illuminance Distribution at 0.5m (clear cover)

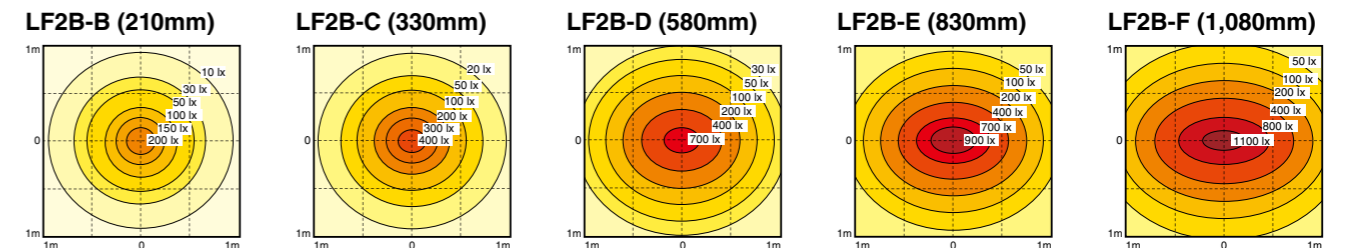

## Dimensions

### With mounting bracket LF9Z-1SB21 (U-shaped brackets supplied with LED)

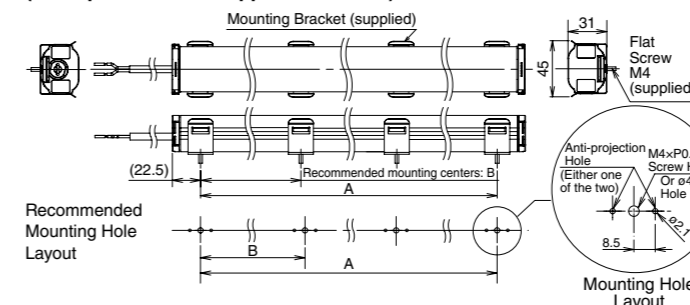

### Mounting bracket LF9Z-1SB21

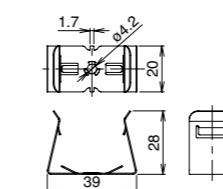

### With mounting bracket LF9Z-1SB22 (L-shaped bracket purchased separately from LED)

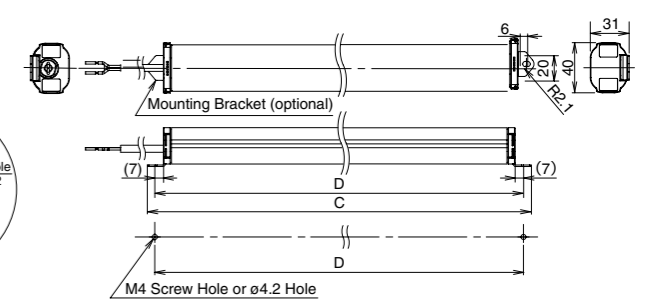

### Mounting bracket LF9Z-1SB22

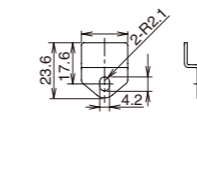

Part No.	A	B	C	D	Required No. of Mounting Bracket	
					LF9Z-1SB21	LF9Z-1SB22
LF2B-B*P-THWW2-1M	165	—	236	224	2	2
LF2B-C*P-THWW2-1M	285	—	356	344	2	
LF2B-D*P-THWW2-1M	535	—	606	594	3	
LF2B-E*P-THWW2-1M	785	393	856	844	4	
LF2B-F*P-THWW2-1M	1,035	345	1,106	1,094	4	

# LUMIFA™ LF1B-N LED Illumination Units

Thin and slim styles fit into compact spaces.  
IP65 (waterproof, dustproof). 6 different lengths and 6 distinct colors.

- Compact design (27.5mm wide, 16mm high, and 134 to 1,080mm long) fits into narrow spaces.
- Improved brightness with white illumination color.
- White, warm white, yellow, red, blue, and green illumination colors.
- Two cover colors: clear and white.

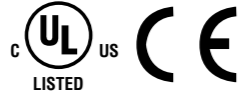

Illumination Color		White	Warm White	Yellow	Red	Blue	Green
Shape	Clear cover						
	White cover						
LF1B-NA (134mm)	Clear cover	LF1B-NA3P-2THWW2*	LF1B-NA3P-2TLWW2*	LF1B-NA3P-2SHY2*	LF1B-NA3P-2SHR2*	LF1B-NA3P-2THS2*	LF1B-NA3P-2SHG2*
	White cover	LF1B-NA4P-2THWW2*	LF1B-NA4P-2TLWW2*	LF1B-NA4P-2SHY2*	LF1B-NA4P-2SHR2*	LF1B-NA4P-2THS2*	LF1B-NA4P-2SHG2*
LF1B-NB (210mm)	Clear cover	LF1B-NB3P-2THWW2*	LF1B-NB3P-2TLWW2*	LF1B-NB3P-2SHY2*	LF1B-NB3P-2SHR2*	LF1B-NB3P-2THS2*	LF1B-NB3P-2SHG2*
	White cover	LF1B-NB4P-2THWW2*	LF1B-NB4P-2TLWW2*	LF1B-NB4P-2SHY2*	LF1B-NB4P-2SHR2*	LF1B-NB4P-2THS2*	LF1B-NB4P-2SHG2*
LF1B-NC (330mm)	Clear cover	LF1B-NC3P-2THWW2*	LF1B-NC3P-2TLWW2*	LF1B-NC3P-2SHY2*	LF1B-NC3P-2SHR2*	LF1B-NC3P-2THS2*	LF1B-NC3P-2SHG2*
	White cover	LF1B-NC4P-2THWW2*	LF1B-NC4P-2TLWW2*	LF1B-NC4P-2SHY2*	LF1B-NC4P-2SHR2*	LF1B-NC4P-2THS2*	LF1B-NC4P-2SHG2*
LF1B-ND (580mm)	Clear cover	LF1B-ND3P-2THWW2*	LF1B-ND3P-2TLWW2*	LF1B-ND3P-2SHY2*	LF1B-ND3P-2SHR2*	LF1B-ND3P-2THS2*	LF1B-ND3P-2SHG2*
	White cover	LF1B-ND4P-2THWW2*	LF1B-ND4P-2TLWW2*	LF1B-ND4P-2SHY2*	LF1B-ND4P-2SHR2*	LF1B-ND4P-2THS2*	LF1B-ND4P-2SHG2*
LF1B-NE (830mm)	Clear cover	LF1B-NE3P-2THWW2*	LF1B-NE3P-2TLWW2*	LF1B-NE3P-2SHY2*	LF1B-NE3P-2SHR2*	LF1B-NE3P-2THS2*	LF1B-NE3P-2SHG2*
	White cover	LF1B-NE4P-2THWW2*	LF1B-NE4P-2TLWW2*	LF1B-NE4P-2SHY2*	LF1B-NE4P-2SHR2*	LF1B-NE4P-2THS2*	LF1B-NE4P-2SHG2*
LF1B-NF (1,080mm)	Clear cover	LF1B-NF3P-2THWW2*	LF1B-NF3P-2TLWW2*	LF1B-NF3P-2SHY2*	LF1B-NF3P-2SHR2*	LF1B-NF3P-2THS2*	LF1B-NF3P-2SHG2*
	White cover	LF1B-NF4P-2THWW2*	LF1B-NF4P-2TLWW2*	LF1B-NF4P-2SHY2*	LF1B-NF4P-2SHR2*	LF1B-NF4P-2THS2*	LF1B-NF4P-2SHG2*
Application		<ul style="list-style-type: none"> <li>• Machine tools</li> <li>• Plant equipment</li> <li>• Inspection/test equipment</li> <li>• Control panel</li> </ul>	<ul style="list-style-type: none"> <li>• Food processing machines</li> <li>• Cosmetic plants</li> <li>• Chemical plants</li> <li>• Showcases</li> </ul>	<ul style="list-style-type: none"> <li>• Semiconductor manufacturing equipment</li> <li>• IC foundries</li> </ul>	<ul style="list-style-type: none"> <li>• Photosensitive materials</li> <li>• Semiconductor manufacturing equipment</li> <li>• Darkroom experiment</li> </ul>	<ul style="list-style-type: none"> <li>• Advertising Display</li> <li>• Light ornaments</li> </ul>	

- Specify cable length in place of \* in Part No. 1M: 1m, 3M: 3m
- Use Class 2 power supply when using the LF1B-N as UL/c-UL listed LED illumination unit.

## Part No. Development

### LF1B - NC3P - 2THWW2 - 1M

<b>Length</b>	<b>Cover</b>	<b>Illumination color</b>	<b>Cable length</b>
A: 134mm B: 210mm C: 330mm D: 580mm E: 830mm F: 1,080mm	3: Clear 4: White	THWW2: White TLWW2: Warm white SHY2: Yellow SHR2: Red THS2: Blue SHG2: Green	1M: 1m 3M: 3m

## Internal Circuit

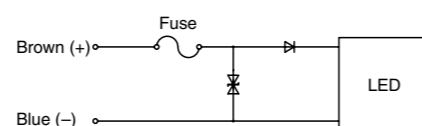

# LF1B-N LED Illumination Units

## Specifications

Model	LF1B-NA (134mm)	LF1B-NB (210mm)	LF1B-NC (330mm)	LF1B-ND (580mm)	LF1B-NE (830mm)	LF1B-NF (1,080mm)	
Rated Voltage	24V DC (operating voltage range: 21.6 to 26.4V)						
Input Current (typ.) (at the rated current)	white/warm white/blue	60mA	120mA	180mA	360mA	540mA	720mA
	red/yellow/green	40mA	80mA	120mA	240mA	360mA	480mA
Power Consumption (typ.) (at the rated voltage)	white/warm white/blue	1.5W	2.9W	4.4W	8.7W	13.0W	17.3W
	red/yellow/green	1.0W	2.0W	2.9W	5.8W	8.7W	11.6W
Insulation Resistance	100MΩ minimum (500V DC megger)						
Dielectric Strength	1,000V AC, 1 minute (between live and dead parts)						
Vibration Resistance (damage limits)	Frequency: 5 to 55 Hz, Amplitude 0.5mm Acceleration 60m/s <sup>2</sup> , 2 hours each in 3 axes				Frequency: 5 to 55 Hz, Amplitude 0.17mm Acceleration 20m/s <sup>2</sup> , 2 hours each in 3 axes		
Shock Resistance (damage limits)	1,000m/s <sup>2</sup> , 5 shocks each in 6 axes				300m/s <sup>2</sup> , 5 shocks each in 6 axes		
Operating Temperature	-30 to +55°C (no freezing)						
Operating Humidity	45 to 85% RH (no condensation)						
Storage Temperature	-35 to +70°C (no freezing)						
Operating Atmosphere	No corrosive gases						
Life (Note)	40,000 hours (Ta = 25°C) (The total illumination life in which the illuminance maintains a minimum of 70% of the initial value.)						
Degree of Protection	IP65 (IEC 60529)						
Material	Cover: polycarbonate, End cover/cable gland: polyamide, Wire: PVC (24AWG x 2C)						
Weight (approx.)	95g	125g	165g	255g	430g	740g	

Note: LED life depends on the operating environment.

## LED Optical Specifications

Illumination Color		White	Warm White	Yellow	Red	Green	Blue
Color Temperature/ Dominant Wavelength (typ.)		5,500K	2,900K	590nm	620nm	525nm	455nm
Reference Illuminance (typ.) at 0.5m directly below	LF1B-NA	Clear: 90 lx White: 80 lx	Clear: 60 lx White: 55 lx	Clear: 20 lx White: 18 lx	Clear: 20 lx White: 18 lx	Clear: 30 lx White: 27 lx	Clear: 10 lx White: 9 lx
	LF1B-NB	Clear: 220 lx White: 200 lx	Clear: 145 lx White: 130 lx	Clear: 40 lx White: 36 lx	Clear: 40 lx White: 36 lx	Clear: 60 lx White: 55 lx	Clear: 20 lx White: 18 lx
	LF1B-NC	Clear: 400 lx White: 360 lx	Clear: 250 lx White: 225 lx	Clear: 75 lx White: 65 lx	Clear: 75 lx White: 65 lx	Clear: 110 lx White: 100 lx	Clear: 30 lx White: 27 lx
	LF1B-ND	Clear: 660 lx White: 600 lx	Clear: 455 lx White: 410 lx	Clear: 125 lx White: 110 lx	Clear: 125 lx White: 110 lx	Clear: 190 lx White: 170 lx	Clear: 50 lx White: 45 lx
	LF1B-NE	Clear: 820 lx White: 740 lx	Clear: 560 lx White: 500 lx	Clear: 160 lx White: 145 lx	Clear: 160 lx White: 145 lx	Clear: 260 lx White: 235 lx	Clear: 60 lx White: 55 lx
	LF1B-NF	Clear: 935 lx White: 850 lx	Clear: 620 lx White: 555 lx	Clear: 180 lx White: 160 lx	Clear: 180 lx White: 160 lx	Clear: 300 lx White: 270 lx	Clear: 80 lx White: 70 lx

• LED modules and illumination units may vary in illumination colors and illuminance.

## Illuminance Distribution at 0.5m (reference value)

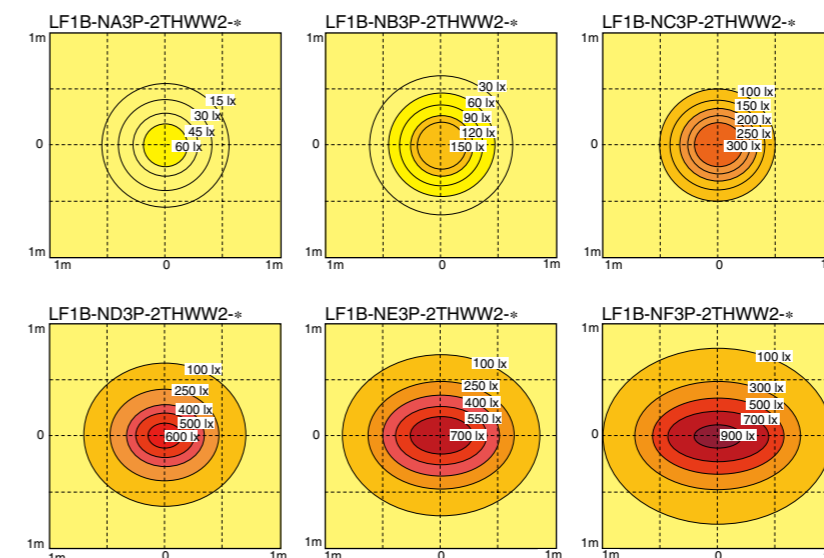

## Dimensions

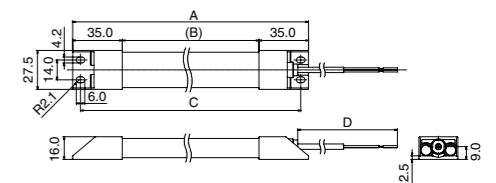

Model	A	B	C
LF1B-NA	134	64	123
LF1B-NB	210	140	199
LF1B-NC	330	260	319
LF1B-ND	580	510	569
LF1B-NE	830	760	819
LF1B-NF	1,080	1,010	1,069

Model	D
LF1B-N*-2*-1M	1,000
LF1B-N*-2*-3M	3,000

All dimensions in mm.

# LUMIFA™ LF1A LED Illumination Units

Energy saving LED illumination units, only 1/3 power consumption compared with fluorescent lamps.

- 40,000 hour service life, no maintenance needed.
- LED modules and highly efficient heat dissipation technology achieves low heat generation.
- Only 22mm high, making it possible to installing inside a small space.
- White, warm white, yellow, and red.



## LED Illumination Units

Illumination Color		White	Warm White	Yellow	Red
Part No.	3 LEDs x 2 columns	LF1A-A1-2THWW6-*	LF1A-A1-2TLWW6-*	LF1A-A1-2SHY8-*	LF1A-A1-2SHR8-*
	6 LEDs x 2 columns	LF1A-B1-2THWW6-*	LF1A-B1-2TLWW6-*	LF1A-B1-2SHY8-*	LF1A-B1-2SHR8-*
	12 LEDs x 2 columns	LF1A-D1-2THWW6-*	LF1A-D1-2TLWW6-*	LF1A-D1-2SHY8-*	LF1A-D1-2SHR8-*
Shape					
Spectrum					
Features	Suppressing glare, the bright, clear white illumination color lights up a target object clearly.		Warm color similar to that of an incandescent light bulb. This illumination color gives off a color temperature of 2800K.		Yellow illumination color gives off an emission spectrum with a dominant wavelength of 590 nm. It does not include 500 nm or shorter wavelengths.
Application Examples	<ul style="list-style-type: none"> <li>• Machine Tools</li> <li>• Control Panel/Plant Equipment</li> <li>• Inspection/Test Equipment</li> </ul>		<ul style="list-style-type: none"> <li>• Food Processing Machines</li> <li>• Cosmetic Plants</li> <li>• Chemical Plants</li> </ul>		<ul style="list-style-type: none"> <li>• Semiconductor Manufacturing Equipment</li> <li>• IC Plants</li> <li>• Application Equipment for Photographic Laboratory</li> <li>• Semiconductor Manufacturing Equipment</li> <li>• Darkroom Experiments</li> </ul>

Note: Insert "U" in place of \* for LED illumination unit with UL/c-UL/CE marking. Use Class 2 power supply when using the LF1A as UL/c-UL listed LED illumination unit.

## Specifications

Part No.	LF1A-*2THWW6 LF1A-*2TLWW6	LF1A-*2SHY8 LF1A-*2SHR8	
Rated Voltage	24V DC (non-polarized)		
Input Current (typ.) (at rated voltage)	3 LEDs x 2 rows	75mA	90mA
	6 LEDs x 2 rows	150mA	180mA
	12 LEDs x 2 rows	300mA	360mA
Rated Power (typ.) (at rated voltage)	3 LEDs x 2 rows	1.8W	2.2W
	6 LEDs x 2 rows	3.6W	4.4W
	12 LEDs x 2 rows	7.2W	8.7W
Insulation Resistance	Between live and dead parts: 100 MΩ (500V DC megger)		
Dielectric Strength	Between live and dead parts: 1000V AC, 1 minute		
Vibration Resistance (Damage limits)	5 to 55Hz, 0.5mm 20m/s <sup>2</sup>		
Shock Resistance (Damage Limits)	980m/s <sup>2</sup>		
Operating Temperature	-20 to 50°C		
Operating/Storage Humidity	45 to 85% RH (no condensation)		
Storage Temperature	-25 to +70°C		
Operating Atmosphere	No corrosive gas		
Life	40000 hours (The total illumination duration in which the luminance maintains a minimum of 70% of the initial value.)		
Weight (approx.)	LF1A-A1: 190g, LF1A-B1: 270g, LF1A-D: 470g		
Degree of Protection	IP40		
Material	Without UL/c-UL/CE marking: Housing: AL, End plate: SPCC, Lens: PMMA (Polymethyl methacrylate), Cable gland: Brass, Wire: PVC (VCTF0.3sq) With UL/c-UL/CE marking: Housing: AL, End plate: SPCC, Lens: PC (Polycarbonate) Cable gland: Brass, Wire: PVC (RO-FLEX1000T AWG22)		

Note: Insert "U" in place of \* for LED illumination unit with UL/c-UL/CE marking.

# LF1A LED Illumination Units

## Part No. Development

LF1A- A1 - 2 THWW6

Rated Voltage  
2: 24V DC

LED arrangement:  
A1: 3 LEDs x 2 columns  
B1: 6 LEDs x 2 columns  
D1: 12 LEDs x 2 columns

LED illumination color  
THWW6: White  
TLWW6: Warm White  
SHY8: Yellow  
SHR8: Red

## LED Optical Specifications

Part No.	LF1A-*2THWW6-*	LF1A-*2TLWW6-*	LF1A-*2SHY8-*	LF1A-*2SHR8-*
Illumination Color	White	Warm White	Yellow	Red
Luminous Intensity (typ.) (Single LED module)	6000mcd	4000mcd	4000mcd	2500mcd
Color Temperature (typ.) / Dominant Wavelength (typ.)	5500K	2800K	590nm	625nm
Reference Illuminance (typ.) at 50 cm	3 LEDs x 2 rows	190 lx	130 lx	85 lx
	6 LEDs x 2 rows	380 lx	260 lx	170 lx
	12 LEDs x 2 rows	760 lx	520 lx	340 lx

Note: Insert "U" in place of \* for LED illumination unit with UL/c-UL/CE marking.

## Dimensions

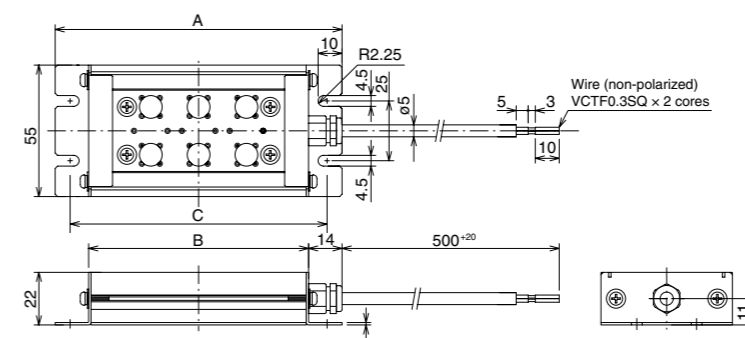

Model	A	B	C
LF1A-A1-*	120	92	108
LF1A-B1-*	180	152	168
LF1A-D1-*	300	272	288

All dimensions in mm.

## Internal Circuit

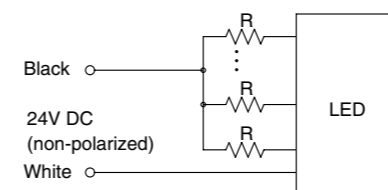

# LUMIFA™ LF1E LED Illumination Units

## LED illumination units for freezer and refrigerated display cases.

- LED light sources achieve energy saving, long service life, reduced mounting space, elimination of noise, and low heat generation.
- Available in 4 lengths of 550, 808, 1066, and 1450 mm designed to meet the width of display cases.
- 3 types of light distribution characteristics are available; no-lens, condensing lens, and dual lens.
- IP54 protection against dust and water.



## Specifications

Model	LF1E-A	LF1E-B	LF1E-C	LF1E-D	LF1E-E
Length (mm)	292	550	808	1066	1450
Rated Voltage	24V DC (voltage range: 21.6 to 26.4V DC)				
Input Current (typ.) (at rated input)	175mA	350 mA	525 mA	700 mA	950 mA
Power Consumption (typ.) (at rated input)	4.2W	8.4W	12.6W	16.8W	22.8W
Insulation Resistance	100 MΩ minimum (500V DC megger) between input and housing				
Dielectric Strength	500V AC, 1 minute				
Vibration Resistance (damage limits)	Frequency 5 to 55 Hz, Amplitude 0.17 mm				
Shock Resistance (damage limits)	300 m/s <sup>2</sup>				
Operating Temperature	-40 to +40°C (no freezing)				
Operating Humidity	45 to 85% RH (no condensation)				
Storage Temperature	-40 to +70°C (no freezing)				
Operating Atmosphere	No corrosive gases				
Life (Note 1)	40,000 hours (The total illumination duration where the illuminance maintains a minimum of 70% of the initial value in 25°C environment.)				
Weight (approx.) (Note 2)	150g	275g	390g	515g	690g
Degree of protection	IP54				
Materials	End cover, conduit: polyamide Cable: PVC		Cover: polycarbonate Mounting bracket: stainless steel		

Note 1: LED life depends on the operating environment. Note 2: Dual lens  
• Use Class 2 power supply when using the LF1E as UL/c-UL listed LED illumination unit.

## LED Optical Specifications (clear lens)

Illumination Color	White		Warm white	
	5000K		3000K	
Color Temperature (typ.)	Illuminance			
Reference Illuminance (typ.) (Measured at 0.3m directly below the unit)	No-lens (Note)	Unit Length	Illuminance	
		292 mm	630 lx	480 lx
		550 mm	950 lx	750 lx
		808 mm	1100 lx	900 lx
		1066 mm	1200 lx	950 lx
		1450 mm	1250 lx	1000 lx
	Condensing Lens (Note)	292 mm	1800 lx	1400 lx
		550 mm	1950 lx	1500 lx
		808 mm	2000 lx	1550 lx
	Dual Lens	1066 mm	2000 lx	1550 lx
		1450 mm	2000 lx	1550 lx
	Dual Lens		See the illuminance distribution chart on page 23.	

Note: LED modules and illumination units may vary in illumination colors and illuminance.

## Part No. Development

### LF1E - B 3 S - 2 N A

Length (mm)  
A: 292  
B: 550  
C: 808  
D: 1,066  
E: 1,450

Light Distribution (Lens)  
Blank: No lens  
A: Condensing lens  
B: Dual lens

LED color  
N: White (5000 K equivalent)  
L: Warm white (3000 K equivalent)

Cover  
3: Clear  
4: White

Input Voltage  
2: 24V DC

Degree of Protection  
S: IP54

## Accessories

Item	Part No.	Package Quantity
Mounting Bracket	LF9Z-1SE1PN05	5

- Five mounting screws are supplied (one mounting screw is used for a mounting bracket)
- Number of mounting brackets supplied: LF1E-B (2), LF1E-C (3), LF1E-D (4) and LF1E-E (4)
- When installing the LF1E unit in the place subject to excessive vibrations, supply additional mounting brackets.
- See page 23 for dimensions.

# LF1E LED Illumination Units

## Dimensions

### LF1E Illumination Unit

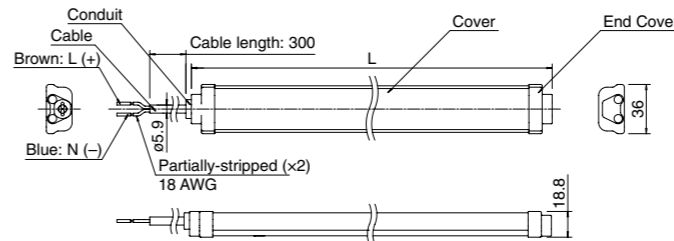

### When using mounting bracket

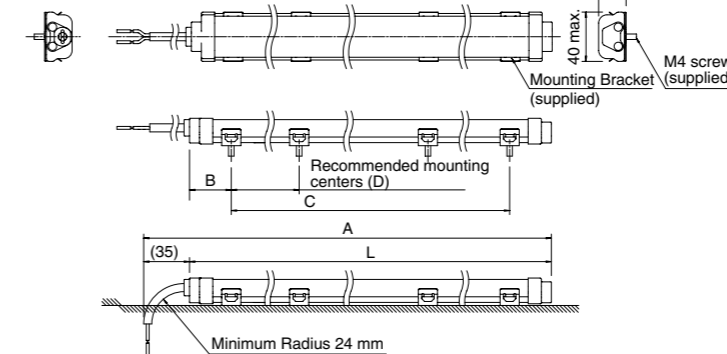

### Mounting Hole Layout

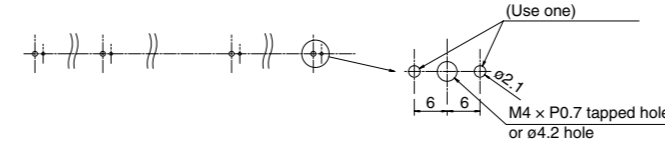

### Mounting Bracket (supplied) (LF9Z-1SE1)

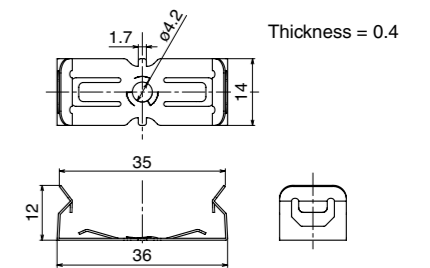

### Mounting Screw (supplied)

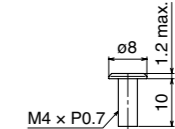

All dimensions in mm.

Model	L	A	B	C	D	No. of Mounting Brackets
LF1E-A	292	327	36	220	220	2
LF1E-B	550	585	30	490	490	2
LF1E-C	808	843	29	750	375	3
LF1E-D	1066	1101	30.5	1005	335	4
LF1E-E	1450	1485	32	1386	462	4

## Illuminance Distribution Chart

### No-lens

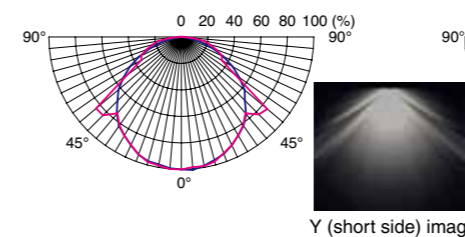

### Condensing Lens

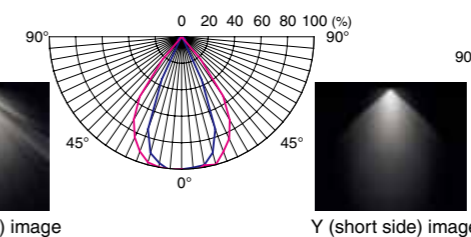

### Dual Lens

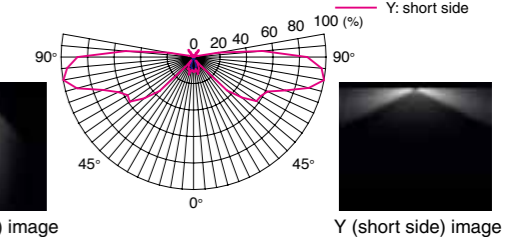

## Illumination Chart (reference value of 5000K at 0.3m. Dual lens type at 50 mm.)

### No-lens (LF1E-E3S-2N)

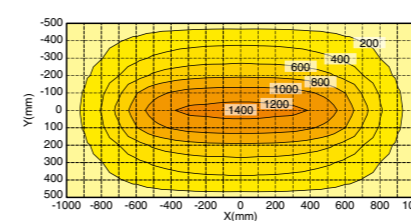

### Condensing Lens (LF1E-E3S-2NA)

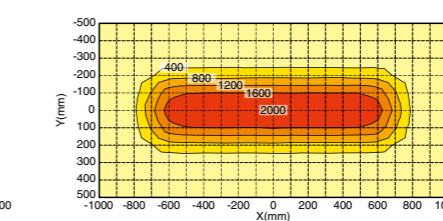

### Dual Lens (LF1E-E3S-2NB)

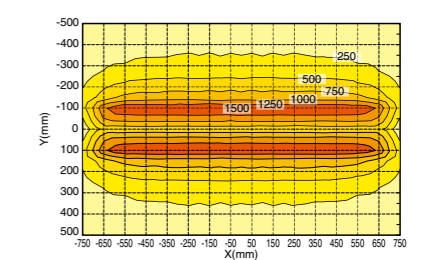

# LF Series Adjustable Angle Mounting Bracket

Mounting angle can be adjusted from 0° to 90°. LED illumination units can be installed flexibly.

- Mounting angle can be adjusted from 0° to 90° in 10° increments, providing more options for mounting of the LED illumination units.
- Illumination angle can be adjusted to suit the operator in various applications, such as visual inspection.

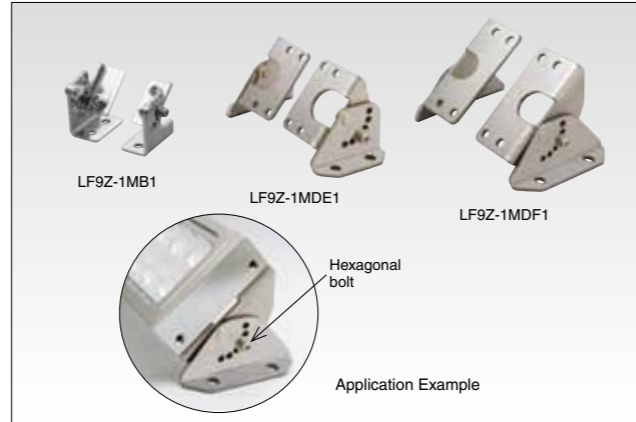

## Adjustable Angle Mounting Bracket

Adjustable Angle Mounting Bracket for LF1D/LF1B	Part No.	Applicable LED Illumination Unit	Material	Package Quantity
	LF9Z-1MDE1	LF1D-E	Stainless Steel	1 pair (right and left) (mounting screws supplied)
	LF9Z-1MDF1	LF1D-F		
	LF9Z-1MB1	LF1B-A, -B, -C (not -D)		

## Dimensions

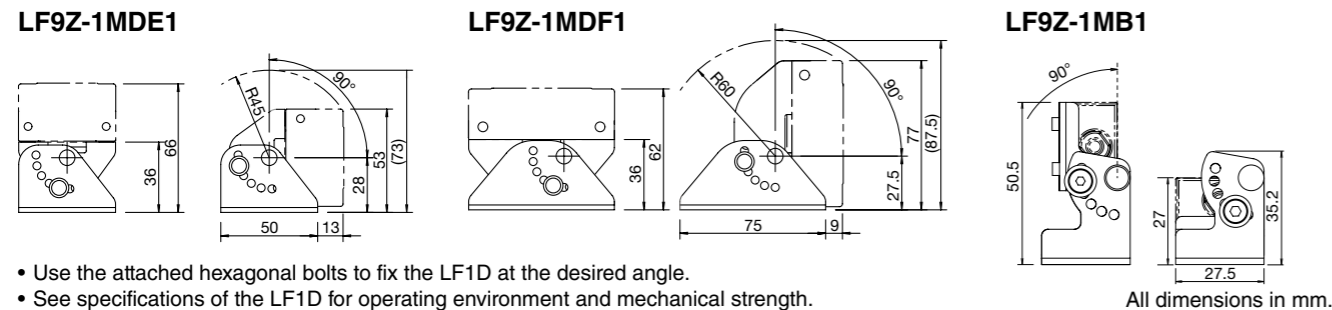

- Use the attached hexagonal bolts to fix the LF1D at the desired angle.
- See specifications of the LF1D for operating environment and mechanical strength.

## Mounting Hole Layout

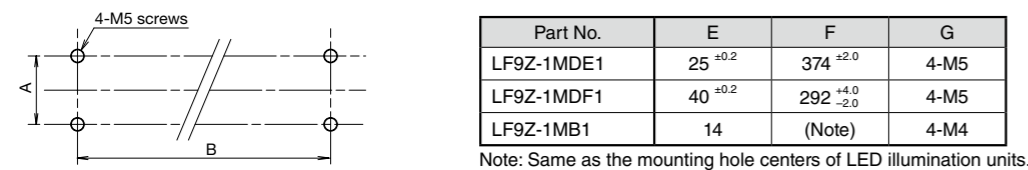

## LF Series LED Illumination Units

### Safety Precautions

- Do not disassemble, repair, or modify the LED illumination unit. Otherwise electric shock, fire, or malfunction may occur.
- Turn off power before wiring. Make sure of correct wiring, otherwise electric shock or damage may result.
- Do not stare directly into the LED illumination unit while it is lit, and do not project the light to other people, otherwise eyes may be injured.
- LED illumination unit is general-purpose industrial electric device. Do not use for electronic equipment which may damage the human body or threaten life in case a malfunction or failure occurs.
- Ensure that the cable does not touch the LED illumination unit.

### Instructions

- LED modules may vary in illumination colors and illuminance.
- Before designing equipment and powering up illumination units, confirm the specifications described in the instruction sheet.
- Apply voltage within the rated value, otherwise the LED elements may be damaged.
- The illumination unit is vulnerable to static electricity. Take sufficient measure for protection against static electricity and voltage surges.
- Make sure that the illumination unit does not fall during transportation, installation, and operation, otherwise damage may result.
- Do not pull or push the cable of the illumination unit, otherwise damage may result. Allow sufficient slack to the cable while wiring.
- Do not apply excessive force. Do not leave a damaged illumination unit unattended or use a damaged illumination unit.
- Ensure the correct operating temperature. Otherwise internal temperature rise may result in damage.
- Do not use or store in a place subjected to vibration and shock.
- Do not use in the following places:
  - \* Exposed to direct sunlight, near heaters, high temperatures
  - \* Subject to chemicals, and corrosive gases (Plastic illumination surface: Iron powder and oil)
  - \* Basements, greenhouses, or other humid places
  - \* Cold storage warehouses (make sure that no freezing occurs)
- Do not loosen screws, otherwise the protection characteristics will be impaired.
- For the LF2D illumination units, make sure to provide sufficient strength for mounting panel. Required waterproof characteristics cannot be obtained if a distorted mounting panel is used.
- To clean the cover, use a soft cloth with water or neutral detergent. Do not use solvents such as thinners, benzene, or alkaline, otherwise discoloration, deterioration, or decrease in strength may occur.
- The edge of the cable sheath is not waterproof construction. Water may invade the LF1B in a capillary action when water splashes directly onto the cable sheath.

# EF1A Flameproof LED Illumination Units

Can be used in hazardous area of Zone 1 and 2, where hydrogen or acetylene gas are present.

- Various mounting styles.
- Condensing or diffused light distribution characteristics.
- Screw terminal, spring clamp terminal, and lead wire connection are available.
- IP67 (IEC 60529)



Package quantity: 1

Input	Light Distribution	Mounting Bracket	Cable Clamp Waterproof	Illumination Surface ①	Terminal Block ②	Applicable Cable Diameter ③	Part No.
100 to 240V AC	Condensing	Direct Mounting	Yes	Clear glass: Blank Translucent glass: 1	Spring clamp: Blank Screw: S Lead wire: C	10: ø8 to ø10 12: ø10 to ø12 14: ø12 to ø14 16: ø14 to ø16	EF1A-12①W②-③
			No				EF1A-12①W②-③W
		Mounting Bracket	Yes				EF1A-12①W②A-③
			No				EF1A-12①W②A-③W
		Angle Adjustable Mounting Bracket	Yes				EF1A-12①W②B-③
			No				EF1A-12①W②B-③W
	Diffused	Direct Mounting	Yes				EF1A-12①W1②-③
			No				EF1A-12①W1②-③W
		Mounting Bracket	Yes				EF1A-12①W1②A-③
			No				EF1A-12①W1②A-③W
		Angle Adjustable Mounting Bracket	Yes				EF1A-12①W1②B-③
			No				EF1A-12①W1②B-③W
24V DC	Condensing	Direct Mounting	Yes	Clear glass: Blank Translucent glass: 1	Spring clamp: Blank Screw: S Lead wire: C	10: ø8 to ø10 12: ø10 to ø12 14: ø12 to ø14 16: ø14 to ø16	EF1A-11①W②-③
			No				EF1A-11①W②-③W
		Mounting Bracket	Yes				EF1A-11①W②A-③
			No				EF1A-11①W②A-③W
		Angle Adjustable Mounting Bracket	Yes				EF1A-11①W②B-③
			No				EF1A-11①W②B-③W
	Diffused	Direct Mounting	Yes				EF1A-11①W1②-③
			No				EF1A-11①W1②-③W
		Mounting Bracket	Yes				EF1A-11①W1②A-③
			No				EF1A-11①W1②A-③W
		Angle Adjustable Mounting Bracket	Yes				EF1A-11①W1②B-③
			No				EF1A-11①W1②B-③W

- Specify "T" before ② in the part number for both input and output ends to have a cable gland. Applicable cable diameter is the same for both ends. Part No. example: EF1A-12WT-10
- Specify "P" before ② and "-A2" at the end of the part number when the input end has cable gland and the output end has ON/OFF switch. Part No. example: EF1A-12W1P-10-A2

## Specifications

Part No.	EF1A-12	EF1A-11
Explosion Protection	Ex d IIC T4	
Installation Area	Zone 1, Zone 2	
Rated Voltage	100 to 240V AC	24V DC
Voltage Range	90 to 264V AC	18 to 26.4V DC
Power Consumption (typ.) (at rated voltage)	19W	16W
Insulation Resistance	100MΩ minimum (500V DC megger) (between input and ground)	
Dielectric Strength	2,000V AC, 1 minute (between input and ground)	
Vibration Resistance (damage limits)	Frequency 5 to 55 Hz, amplitude 0.5mm	
Shock Resistance (damage limits)	1,000 m/s <sup>2</sup>	
Operating Temperature	-20 to +50°C (no freezing)	
Operating Humidity	45 to 85% RH (no condensation)	
Storage Temperature	-35 to +70°C (no freezing)	
Service Life (Note)	Approx. 50,000 hours minimum (The total illumination duration where the illuminance maintains a minimum of 70% of the initial value in 25°C environment.)	
Degree of Protection	IP67 (IEC 60529), IP65 (with ON/OFF switch)	
Material	Housing: aluminium, front panel/mounting bracket: stainless steel, illumination surface: reinforced glass, cable gland: nickel-plated brass	
Weight (approx.)	3.2kg (direct mounting)	3.4kg (with mounting bracket)

Note: LED life depends on the operating environment.

## Part No. Development

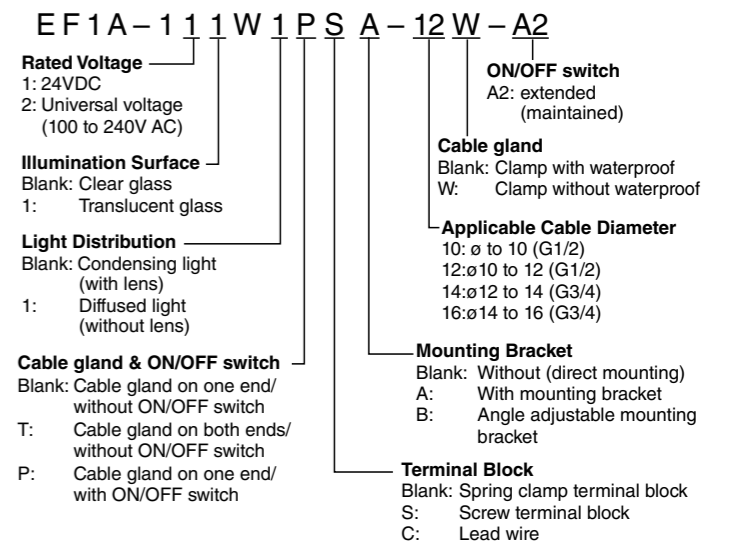

# EF1A Flameproof LED Illumination Units

## LED Optical Specifications

Illumination Surface	Clear glass		Translucent glass	
	With (condensing light)	Without (diffused light)	With (condensing light)	Without (diffused light)
Illumination Color	White			
Color Temperature (typ.)	5,700K			
Total Luminous Flux (typ.)	960 lm			
Reference Illuminance (typ.) (at 1.0m directly below)	1100 lx	205 lx	450 lx	175 lx

## TIIS Certified Products of the Same Model

Part No.	Lens	ON/OFF switch	TIIS Type Test Approval No.
EF1A-1*W	With (condensing light)	Without	TC19541
EF1A-1*WP	With (condensing light)	With	TC19542
EF1A-1*W1	Without (diffused light)	Without	TC19540
EF1A-1*W1P	Without (diffused light)	With	TC19543

\* Same model range includes voltage, illumination surface glass, cable gland type and size.

## Illumination Distribution Chart (unit: cd/1000 lm)

### Condensing Light

Illumination Surface: Clear glass (with lens)

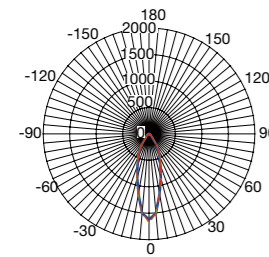

### Diffused Light

Illumination Surface: Translucent glass (with lens)

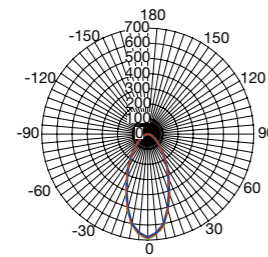

### Condensing Light

Illumination Surface: Clear glass (without lens)

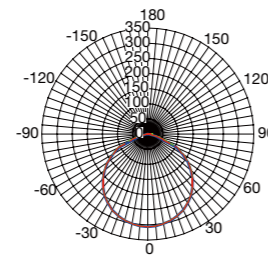

### Diffused Light

Illumination Surface: Translucent glass (without lens)

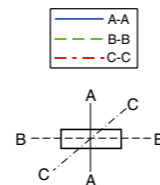
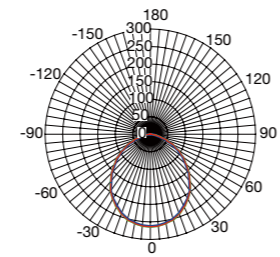

## Illuminance Distribution at 1.0m (reference value)

### Condensing Light (lx)

Illumination Surface: Clear glass (with lens)

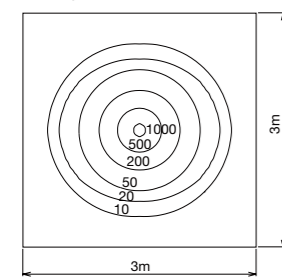

Illumination Surface: Translucent glass (with lens)

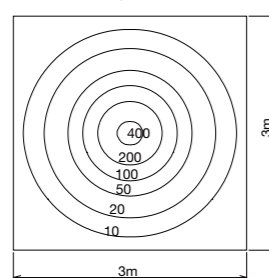

Illumination Surface: Clear glass (without lens)

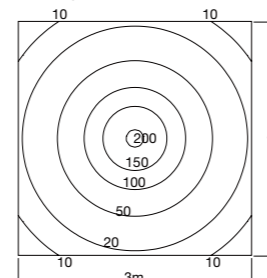

Illumination Surface: Translucent glass (without lens)

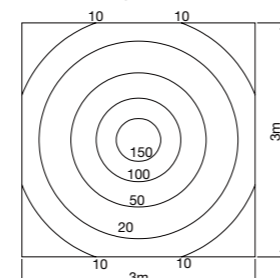

## Dimensions

### W/Angle Adjustable Mounting Bracket

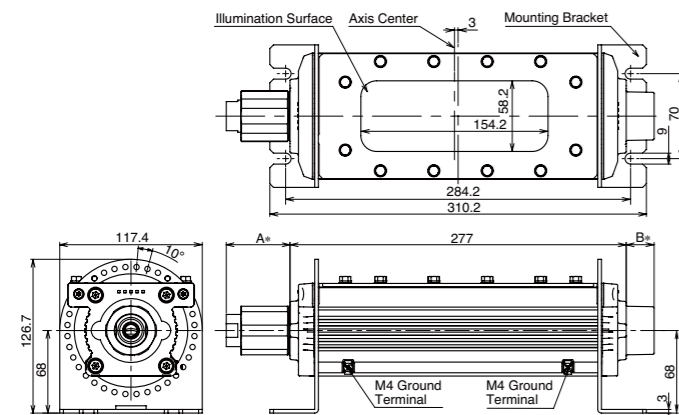

### W/Mounting Bracket

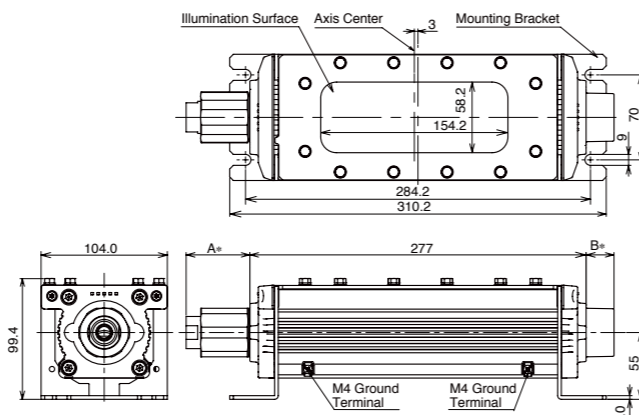

\* See page 27 for the dimensions of A and B.

All dimensions in mm.

# EF1A Flameproof LED Illumination Units

## Direct Mounting

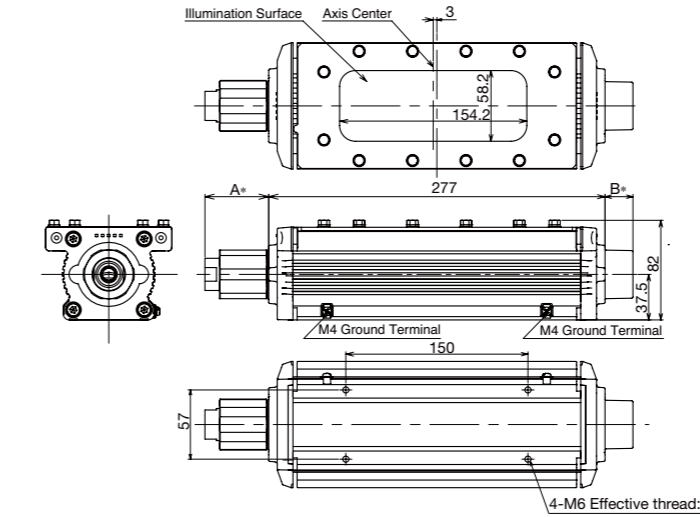

## Mounting Hole Layout

### Direct Mounting

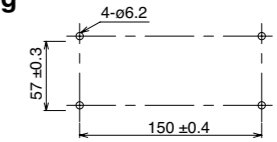

### With Mounting Bracket

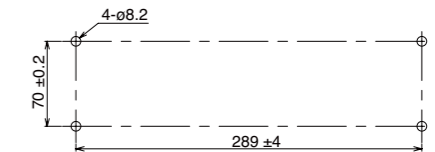

All dimensions in mm.

\* See below for the dimensions of A and B.

## With Cable Gland: A or B

A/B: 52.5 to 59.5

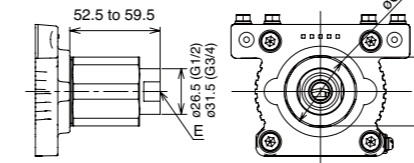

## Without Cable Gland: B only

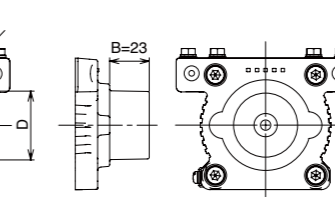

A/B: 53 to 60

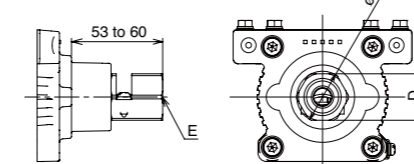

## With ON/OFF Switch: B only

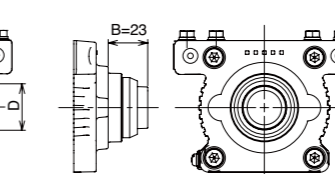

## Dimensions (mm)

Cable Gland Code	Applicable Cable Diameter X	Dimensions			Clamp Waterproof
		C	D	E (*)	
10	8 < X ≤ 10	42	40	G1/2 (16)	With
12	10 < X ≤ 12	42	40	G1/2 (16)	
14	12 < X ≤ 14	42	40	G3/4 (22)	
16	14 < X ≤ 16	42	40	G3/4 (22)	
10W	8 < X ≤ 10	30	27	G1/2 (16)	Without
12W	10 < X ≤ 12	30	27	G1/2 (16)	
14W	12 < X ≤ 14	33	30	G3/4 (22)	
16W	14 < X ≤ 16	33	30	G3/4 (22)	

\*: Nominal size

## Safety Precautions

- Do not disassemble, repair, or modify the LED illumination unit. Otherwise electric shock, fire, or malfunction may occur.
- Special expertise is required to install, operate, maintain, and inspect the EF1A. People without such expertise must not use the

- EF1A. Otherwise electric shocks, damage, or malfunction may result.
- Read this catalog and instruction sheet carefully before using the EF1A.

## Instructions

### Installation Area

- Degree of protection for the EF1A is IP67 (with ON/OFF switch: IP65). Do not use in harsher environment.
- Operating temperature is -20 to +50°C. When the surface temperature of EF1A might exceed +50°C due to direct sunlight, provide a shade to keep the surface temperature below +50°C.
- When installing the EF1A, observe safety standards and regulations of the relevant country or region.

### Installation

- For direct mounting without mounting bracket, use four M6 bolts. When using mounting brackets, use four M8 bolts or install firmly so that equivalent mounting strength is provided. Mounting bracket is 3 mm thick (see dimensions). Recommended tightening strength is as follows. M6: 3.9 to 5.4 N·m, M8: 10 to 13.5 N·m.
- If bolt loosening is expected due to vibrations, use spring washers.

### Installing/Removing the End Cover

- When removing the end cover, use a hex key supplied with the EF1A to remove the end cover bolts (M6 × 18 hex socket head cap bolt with spring washer and plain washer). Do not lose the end cover bolts.

- The end cover is inserted into the housing. When installing the end cover, make sure that the end cover is inserted straight.
- When installing the end cover, observe the followings.
  - No foreign objects are on the gasket or joint surface.
  - The gasket is in place.
  - The wires are not caught between the joint surfaces.
- Install the end cover slowly and tighten screws to a torque of 3.9 to 5.4 N·m.

Note: Make sure that the bolts are tightened securely.

### Drawing a Cable

- Use the flameproof packing type cable gland supplied with the EF1A. Refer to the dimensions. See "Connecting a Cable to the Flameproof Packing Type Cable Gland" for details.
- When choosing a cable, take maximum operating temperature and chemical resistance of insulator and sheath into consideration. The inside of cable must be as solid as possible to prevent ingress of explosive gas through the cable, and smooth on surface and round in cross-section. When choosing the size and insulation material, take the temperature rise of cable into consideration.
- Protect the cable against external damage by encasing in a metal conduit, or in a metal/cement duct.

# EF1A Flameproof LED Illumination Units

## Wiring

### Applicable Wire

- Stranded wire: 0.5 to 2.0 mm<sup>2</sup>, Solid wire:  $\phi$ 0.5 to  $\phi$ 2.0 mm<sup>2</sup> (AWG16-12)
- Connect one wire to one terminal. When connecting an insulated wire to the terminal block, use a crimping terminal with insulation sheath. Bare crimping terminal must be insulated with an insulation tube or making tube. Make sure not to apply excessive force to the terminal block when installing the end cover.

### Applicable Crimping Terminal

Screw Terminal  
(Ring Terminal)

Spring Clamp Terminal (WAGO: 741-302)  
(Ferrule)

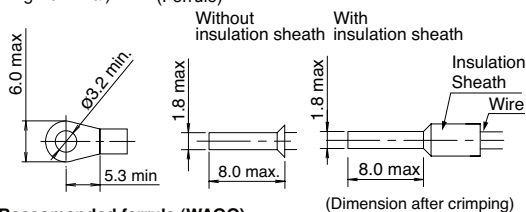

#### Recommended ferrule (WAGO)

Ferrule with insulation sheath: 216-204  
Ferrule without insulation sheath: 216-104  
Crimping too: 206-204

### Recommended Tightening Torque

- Screw terminal block (M3): 0.5 to 0.8 N·m

### Wiring Cable Gland on Both Ends

- A maximum of four EF1A can be connected. Do not connect more than four EF1As, otherwise the input current may exceed the limit.

## Protective Grounding

- Ground the EF1A according to the environment and ratings of the application. Observe the regulations of the relevant country or region where the EF1A is used.
- Use the M4 grounding terminal inside the EF1A and make sure that the ground resistance value is under 100 $\Omega$ .
- When not using the M4 grounding terminal inside the EF1A, use the external M4 grounding terminal.  
Recommended tightening torque (M4): 1.4 to 2.0 N·m.
- Use a wire in size and material which is durable against the maximum expected grounding current. Protect the grounding wire against external damage by encasing in a metal conduit.

## Connecting a Cable to the Flameproof Packing Type Cable Gland

- When choosing a cable, take maximum operating temperature and chemical resistance of insulator and sheath into consideration. The inside of cable must be as solid as possible to prevent ingress of explosive gas through the cable, and smooth on surface and round in cross-section. When choosing the size and insulation material, take the temperature rise of cable into consideration.
- Protect the cable against external damage by encasing in a metal conduit, or in a metal/cement duct.

## Parts Description

(Part number without W on cable gland)

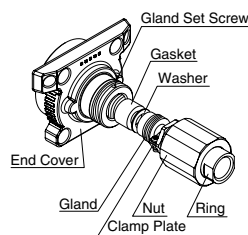

### Connecting a Cable

1. Make sure that the cable gland matches the cable diameter. If not, replace the cable. Or replace the EF1A with one that has the cable gland with matching cable diameter.
2. Remove the parts from the end cover in the order of nut, ring, gland, washer, and gasket. The gland can be removed by loosening the gland set screw using the hex key (size 2).

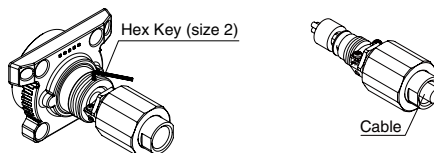

3. Loosen the clamp plate screws. Pass the cable through the nut, ring, gland, washer, and gasket.
4. Place the gasket and washer in the end cover, and screw in the gland to compress the gasket. Tighten the gland until the cable does not move when pulled out lightly, and tighten further one full turn. If the clamp plate is in the posture which is difficult to be approached by a screwdriver, turn the gland for  $\pm 1/3$  turn. Tighten the gland set screw. Tighten the clamp plate set screws equally to fixate the cable.

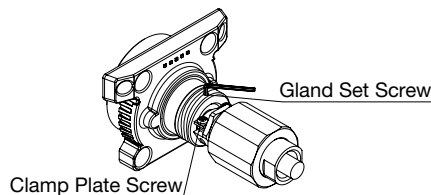

5. Screw the nut into the end cover.

(Part number without W on cable gland)

- Connect the cable in the same manner as described above.

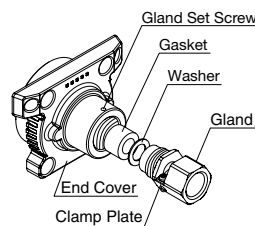

Specifications and other descriptions in this catalog are subject to change without notice.



## IDEC CORPORATION

7-31, Nishi-Miyahara 1-Chome, Yodogawa-ku, Osaka 532-8550, Japan  
Tel: +81-6-6398-2571, Fax: +81-6-6392-9731  
E-mail: marketing@idec.co.jp

### IDEC CORPORATION (USA)

1175 Elko Drive  
Sunnyvale, CA 94089-2209, USA  
Tel: +1-408-747-0550 / (800) 262-IDEC (4332)  
Fax: +1-408-744-9055 / (800) 635-6246  
E-mail: opencontact@idec.com

### IDEC CANADA LIMITED

3155 Pepper Mill Court, Unit 4  
Mississauga, Ontario, L5L 4X7, Canada  
Tel: +1-905-890-8561  
Toll Free: (800) 262-IDEC (4332)  
Fax: +1-905-890-8562  
E-mail: sales@ca.idec.com

### IDEC AUSTRALIA PTY. LTD.

Unit 17, 104 Ferntree Gully Road,  
Oakleigh, Victoria 3166, Australia  
Tel: +61-3-8523-5900, Toll Free: 1800-68-4332  
Fax: +61-3-8523-5999  
E-mail: sales@au.idec.com

### IDEC ELECTRONICS LIMITED

Unit 2, Beechwood, Chineham Business Park,  
Basingstoke, Hampshire RG24 8WA, UK  
Tel: +44-1256-321000, Fax: +44-1256-327755  
E-mail: sales@uk.idec.com

### IDEC ELEKTROTECHNIK GmbH

Wendenstrasse 331, 20537 Hamburg, Germany  
Tel: +49-40-25 30 54 - 0, Fax: +49-40-25 30 54 - 24  
E-mail: service@idec.de

### IDEC (SHANGHAI) CORPORATION

Room 701-702 Chong Hing Finance Center,  
No. 288 Nanjing Road West, Shanghai 200003, PRC  
Tel: +86-21-6135-1515  
Fax: +86-21-6135-6225 / +86-21-6135-6226  
E-mail: idec@cn.idec.com

### IDEC (BEIJING) CORPORATION

Room 211B, Tower B, The Grand Pacific Building,  
8A Guanghua Road, Chaoyang District,  
Beijing 100026, PRC  
Tel: +86-10-6581-6131, Fax: +86-10-6581-5119

### IDEC (SHENZHEN) CORPORATION

Unit AB-3B2, Tian Xiang Building, Tian'an Cyber Park,  
Fu Tian District, Shenzhen, Guang Dong 518040, PRC  
Tel: +86-755-8356-2977, Fax: +86-755-8356-2944

### IDEC IZUMI (H.K.) CO., LTD.

Units 11-15, Level 27, Tower 1,  
Millennium City 1, 388 Kwun Tong Road,  
Kwun Tong, Kowloon, Hong Kong  
Tel: +852-2803-8989, Fax: +852-2565-0171  
E-mail: info@hk.idec.com

### IDEC TAIWAN CORPORATION

8F-1, No. 79, Hsin Tai Wu Road, Sec. 1,  
Hsi-Chih District, 22101 New Taipei City, Taiwan  
Tel: +886-2-2698-3929, Fax: +886-2-2698-3931  
E-mail: service@tw.idec.com

### IDEC IZUMI ASIA PTE. LTD.

No. 31, Tannery Lane #05-01,  
HB Centre 2, Singapore 347788  
Tel: +65-6746-1155, Fax: +65-6844-5995  
E-mail: info@sg.idec.com