

P/N: SC52-11EWA

HIGH EFFICIENCY RED

### Features

- 0.52 INCH DIGIT HEIGHT.
- EXCELLENT CHARACTER APPEARANCE.
- EASY MOUNTING ON P.C. BOARDS OR SOCKETS.
- I.C. COMPATIBLE.
- MECHANICALLY RUGGED.
- STANDARD : GRAY FACE, WHITE SEGMENT.
- RoHS COMPLIANT.

### Description

The High Efficiency Red source color devices are made with Gallium Arsenide Phosphide on Gallium Phosphide Orange Light Emitting Diode.

### Package Dimensions & Internal Circuit Diagram

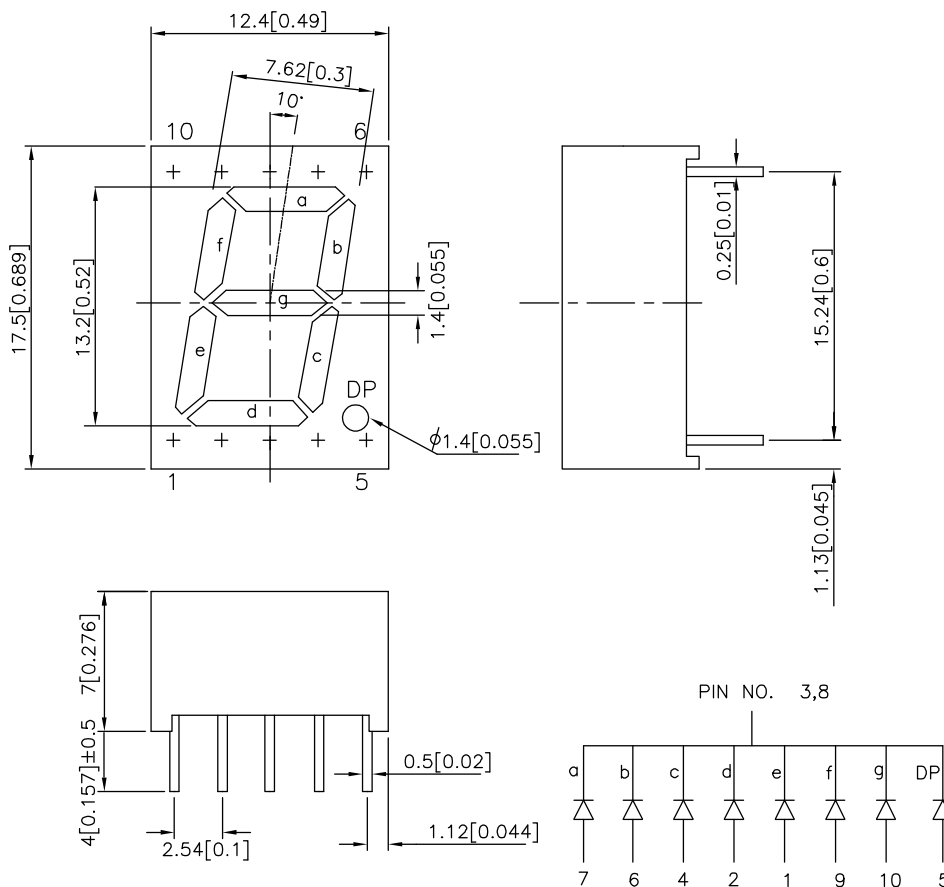

**Notes:**

1. All dimensions are in millimeters (inches), Tolerance is  $\pm 0.25(0.01)$  unless otherwise noted.
2. Specifications are subject to change without notice.

## Selection Guide

Part No.	Dice	Lens Type	Iv (ucd) @ 10mA		Description
			Min.	Typ.	
SC52-11EWA	HIGH EFFICIENCY RED(GaAsP/GaP)	WHITE DIFFUSED	1200	6400	Common Cathode, Rt. Hand Decimal.

## Electrical / Optical Characteristics at TA=25°C

Symbol	Parameter	Device	Typ.	Max.	Units	Test Conditions
$\lambda_{peak}$	Peak Wavelength	High Efficiency Red	627		nm	IF=20mA
$\lambda_D$	Dominant Wavelength	High Efficiency Red	625		nm	IF=20mA
$\Delta\lambda_{1/2}$	Spectral Line Half-width	High Efficiency Red	45		nm	IF=20mA
C	Capacitance	High Efficiency Red	15		pF	VF=0V;f=1MHz
VF	Forward Voltage	High Efficiency Red	2.0	2.5	V	IF=20mA
IR	Reverse Current	High Efficiency Red		10	uA	VR = 5V

## Absolute Maximum Ratings at TA=25°C

Parameter	High Efficiency Red	Units
Power dissipation	105	mW
DC Forward Current	30	mA
Peak Forward Current [1]	160	mA
Reverse Voltage	5	V
Operating/Storage Temperature	-40°C To +85°C	
Lead Solder Temperature [2]	260°C For 5 Seconds	

### Notes:

- 1/10 Duty Cycle, 0.1ms Pulse Width.
- 2mm below package base.

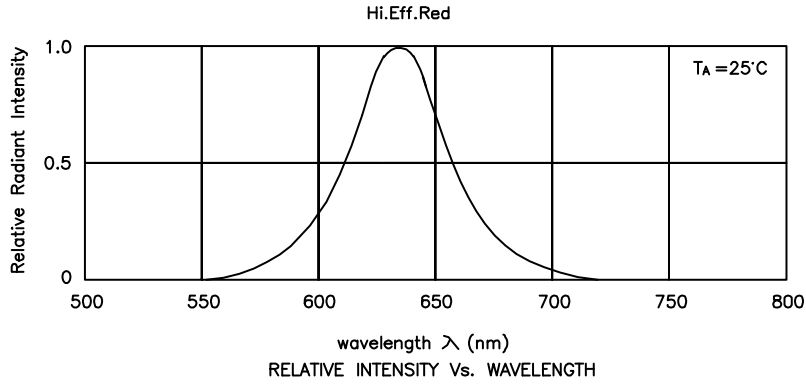

## High Efficiency Red

## SC52-11EWA

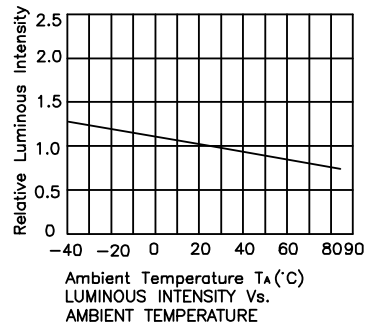
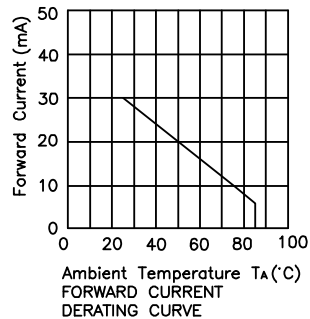
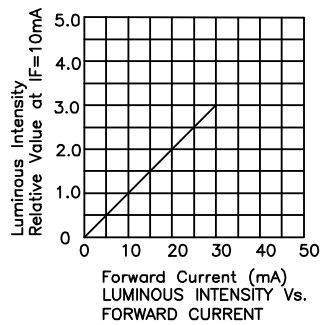
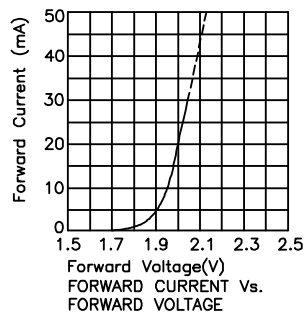

## PACKING & LABEL SPECIFICATIONS

## SC52-11EWA

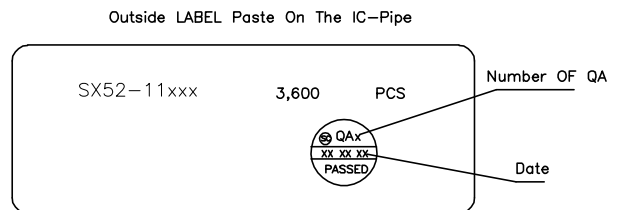
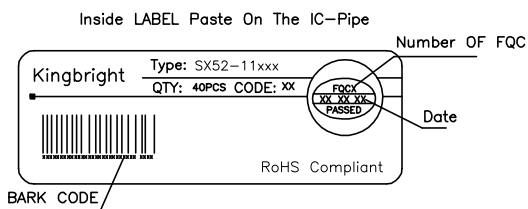
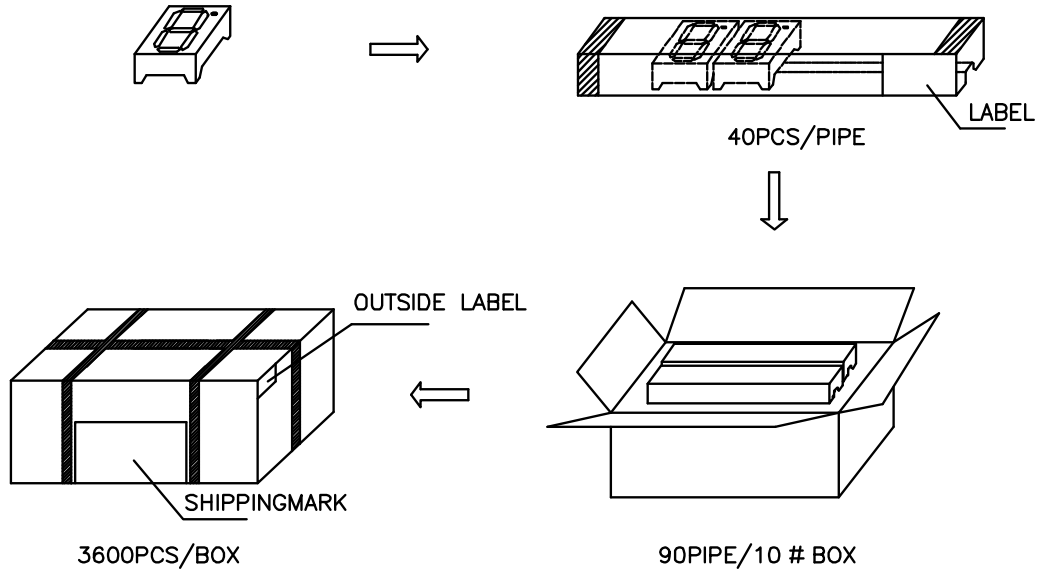

### Remarks:

If special sorting is required (e.g. binning based on forward voltage, luminous intensity / luminous flux, or wavelength), the typical accuracy of the sorting process is as follows:

1. Wavelength: +/-1nm
2. Luminous Intensity / Luminous Flux: +/-15%
3. Forward Voltage: +/-0.1V

Note: Accuracy may depend on the sorting parameters.