

# Standard Rectifier

3~ Bipolar Bridge

$V_{RRM} = 1600 \text{ V}$   
 $I_{DAV} = 40 \text{ A}$   
 $V_F = 1.05 \text{ V}$

Part number

**GUO40-16NO1**

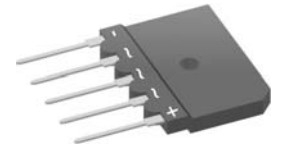
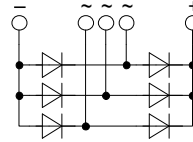

Backside: isolated

E326641

**Features / Advantages:**

- Low forward voltage drop
- Planar passivated chips
- Easy to mount with one screw
- Space and weight savings

**Applications:**

- Supplies for DC power equipment
- Input rectifiers for PWM inverter
- Battery DC power supplies
- Field supply for DC motors

**Package:**

- Housing: GUPF
- Industry standard outline
- Plastic overmolded tab for electrical isolation
- Isolation Voltage 2500 V
- Epoxy meets UL 94V-0
- RoHS compliant

Symbol	Definition	Conditions	Ratings			Unit	
			min.	typ.	max.		
$V_{RRM}$	max. repetitive reverse voltage				1600	V	
$I_R$	reverse current	$V_R = 1600 \text{ V}$			50	$\mu\text{A}$	
		$V_R = 1600 \text{ V}$			1.5	mA	
$V_F$	forward voltage	$I_F = 12.5 \text{ A}$			1.15	V	
		$I_F = 25 \text{ A}$			1.30	V	
		$I_F = 12.5 \text{ A}$	$T_{VJ} = 125^\circ\text{C}$			1.05	V
		$I_F = 25 \text{ A}$	$T_{VJ} = 125^\circ\text{C}$			1.20	V
$I_{DAV}$	bridge output current	120° sine			40	A	
$V_{F0}$	threshold voltage	} for power loss calculation only			0.86	V	
$r_F$	slope resistance				12.9	m $\Omega$	
$R_{thJC}$	thermal resistance junction to case				4.30	K/W	
$T_{VJ}$	virtual junction temperature		-40		175	$^\circ\text{C}$	
$P_{tot}$	total power dissipation				35	W	
$I_{FSM}$	max. forward surge current	$t = 10 \text{ ms}; (50 \text{ Hz}), \text{ sine}$	$T_{VJ} = 45^\circ\text{C}$			370	A
		$t = 8,3 \text{ ms}; (60 \text{ Hz}), \text{ sine}$	$V_R = 0 \text{ V}$			400	A
		$t = 10 \text{ ms}; (50 \text{ Hz}), \text{ sine}$	$T_{VJ} = 150^\circ\text{C}$			315	A
		$t = 8,3 \text{ ms}; (60 \text{ Hz}), \text{ sine}$	$V_R = 0 \text{ V}$			340	A
$I^2t$	value for fusing	$t = 10 \text{ ms}; (50 \text{ Hz}), \text{ sine}$	$T_{VJ} = 45^\circ\text{C}$			685	A <sup>2</sup> s
		$t = 8,3 \text{ ms}; (60 \text{ Hz}), \text{ sine}$	$V_R = 0 \text{ V}$			665	A <sup>2</sup> s
		$t = 10 \text{ ms}; (50 \text{ Hz}), \text{ sine}$	$T_{VJ} = 150^\circ\text{C}$			495	A <sup>2</sup> s
		$t = 8,3 \text{ ms}; (60 \text{ Hz}), \text{ sine}$	$V_R = 0 \text{ V}$			480	A <sup>2</sup> s
$C_J$	junction capacitance	$V_R = 400 \text{ V}; f = 1 \text{ MHz}$	$T_{VJ} = 25^\circ\text{C}$		11	pF	

Symbol	Definition	Conditions	Ratings			Unit
			min.	typ.	max.	
$I_{RMS}$	RMS current	per terminal			70	A
$R_{thCH}$	thermal resistance case to heatsink			0.50		K/W
$T_{stg}$	storage temperature		-55		150	°C
<b>Weight</b>				8.5		g
$M_D$	mounting torque		0.8		1.2	Nm
$F_C$	mounting force with clip		20		120	N
$V_{ISOL}$	isolation voltage	t = 1 second	2500			V
		t = 1 minute	2000			V
$d_{Spp/App}$	creepage   striking distance on surface   through air	terminal to terminal	6.7	5.4		mm
$d_{Spb/Ab}$	creepage   striking distance on surface   through air	terminal to backside	10.0	8.0		mm

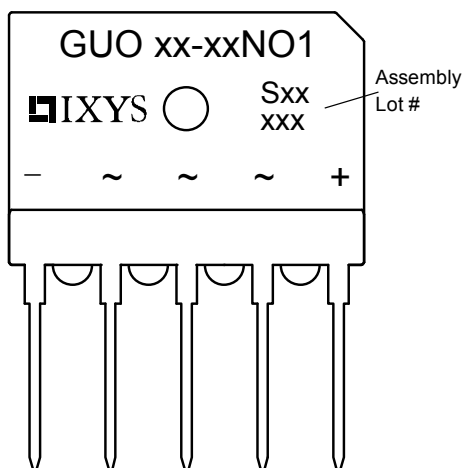

Ordering	Part Name	Marking on Product	Delivering Mode	Base Qty	Code Key
Standard	GUO40-16NO1	GUO40-16NO1	Tube	15	504437

Similar Part	Package	Voltage class
GUO40-12NO1	GUFP	1200
GUO40-08NO1	GUFP	800

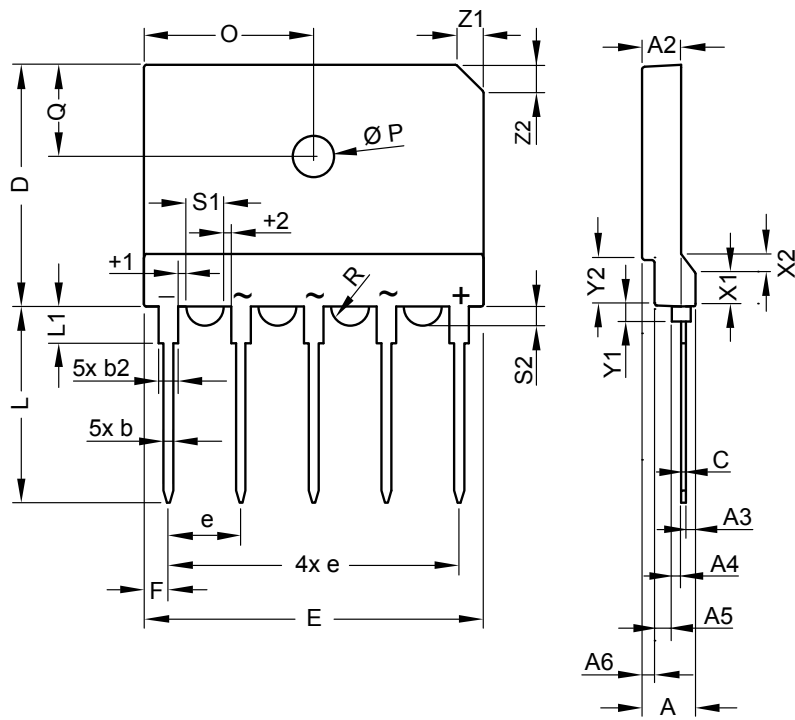
**Outlines GUPF**

Dim.	Millimeter			Inches		
	min	typ.	max	min	typ.	max
A	5.40	5.50	5.60	0.213	0.217	0.221
A2	3.90	4.00	4.10	0.154	0.158	0.162
A3	0.95	1.00	1.10	0.037	0.039	0.043
A4	0.95	1.00	1.05	0.037	0.039	0.041
A5	1.60	1.70	1.80	0.063	0.067	0.071
A6	1.25	1.30	1.35	0.049	0.051	0.053
b	0.95	1.00	1.05	0.037	0.039	0.041
b2	1.95	2.00	2.05	0.077	0.079	0.081
C	0.45	0.50	0.55	0.018	0.020	0.022
D	24.80	25.00	25.20	0.977	0.985	0.993
E	34.70	35.00	35.30	1.367	1.379	1.391
e	BSC 7.50			BSC 0.296		
F	2.40	2.50	2.60	0.095	0.099	0.102
L	2.30	20.40	2.50	0.091	0.804	0.099
L1	3.70	3.75	3.80	0.146	0.148	0.150
O	17.40	17.50	17.60	0.686	0.690	0.693
$\varnothing P$	4.10	4.20	4.30	0.162	0.165	0.169
Q	9.20	9.30	9.40	0.362	0.366	0.370
$\varnothing/2 R$		1.77			0.070	
s1	3.45	3.50	3.55	0.136	0.138	0.140
s2	1.45	1.50	1.55	0.057	0.059	0.061
t1	0.95	1.00	1.05	0.037	0.039	0.041
t2	0.95	1.00	1.05	0.037	0.039	0.041
x1	3.20	3.30	3.40	0.126	0.130	0.134
x2	1.90	2.00	2.10	0.075	0.079	0.083
y1	1.60	1.65	1.70	0.063	0.065	0.067
y2	4.65	4.70	4.75	0.183	0.185	0.187
z1	2.80	2.90	3.00	0.110	0.114	0.118

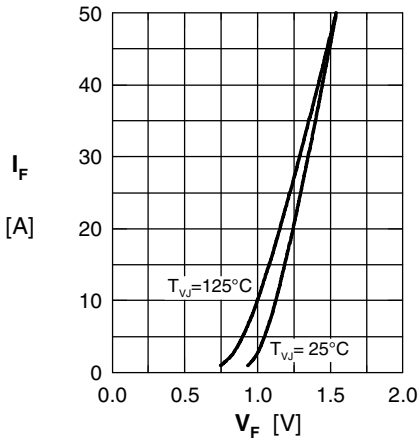

Fig. 1 Forward current versus voltage drop per diode

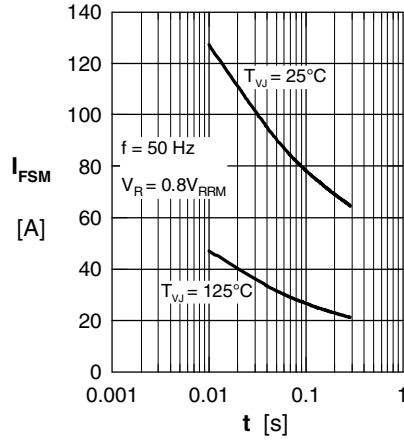

Fig. 2 Surge overload current

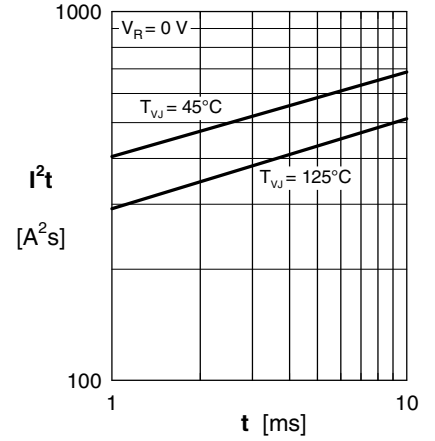

Fig. 3  $I^2t$  versus time per diode

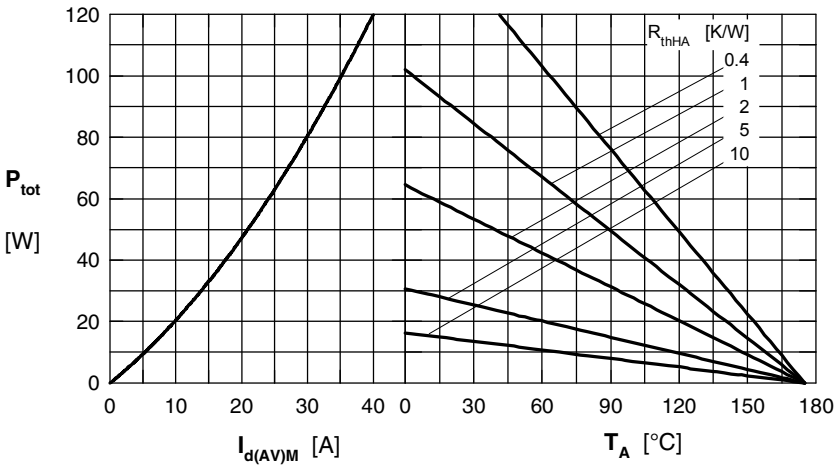

Fig. 4 Power dissipation versus direct output current and ambient temperature, sine 180°

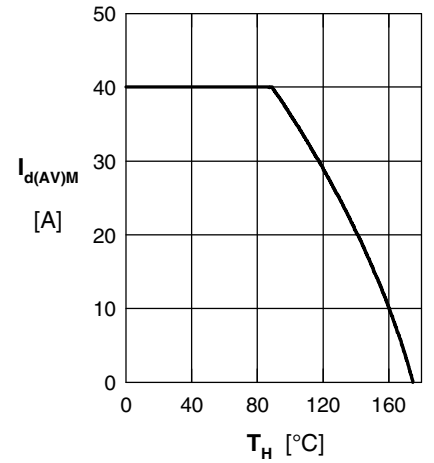

Fig. 5 Max. forward current vs. case temperature

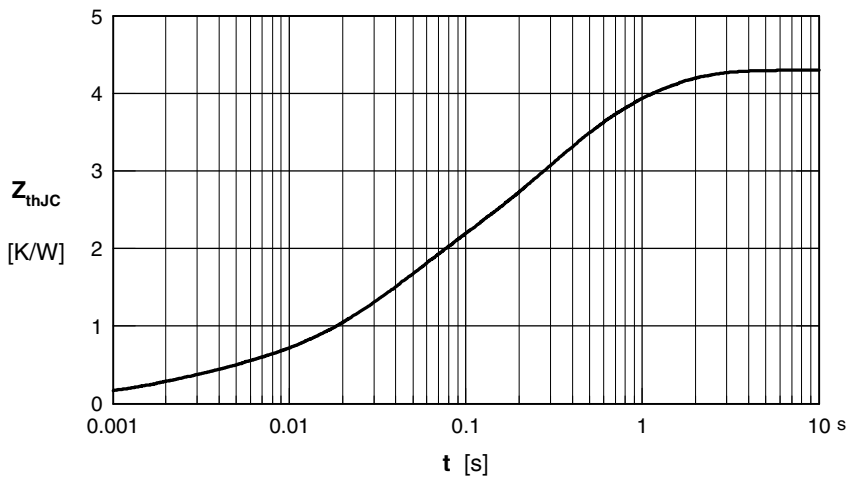

Fig. 6 Transient thermal impedance junction to case

Constants for  $Z_{thJC}$  calculation:

i	$R_{thi}$ [K/W]	$t_i$ [s]
1	0.302	0.002
2	1.252	0.032
3	1.582	0.227
4	1.164	0.82