

Schottky Diode Gen²

High Performance Schottky Diode
Low Loss and Soft Recovery
Common Cathode

$V_{RRM} = 150\text{ V}$
 $I_{FAV} = 2 \times 35\text{ A}$
 $V_F = 0.77\text{ V}$

Part number

DSA 70 C 150 HB

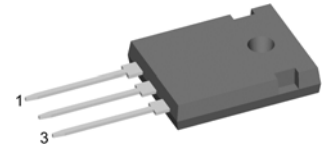
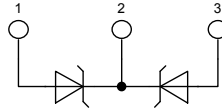

Backside: cathode

Features / Advantages:

- Very low V_f
- Extremely low switching losses
- low I_{rm} values
- Improved thermal behaviour
- High reliability circuit operation
- Low voltage peaks for reduced protection circuits
- Low noise switching

Applications:

- Rectifiers in switch mode power supplies (SMPS)
- Free wheeling diode in low voltage converters

Package:

- Housing: TO-247
- Industry standard outline
- Epoxy meets UL 94V-0
- RoHS compliant

Symbol	Definition	Conditions	Ratings			Unit
			min.	typ.	max.	
V_{RRM}	max. repetitive reverse voltage				150	V
I_R	reverse current	$V_R = 150\text{ V}$			0.68	mA
		$V_R = 150\text{ V}$			7.5	mA
V_F	forward voltage	$I_F = 35\text{ A}$			0.90	V
		$I_F = 70\text{ A}$			1.06	V
		$I_F = 35\text{ A}$			0.77	V
		$I_F = 70\text{ A}$			0.94	V
I_{FAV}	average forward current	rectangular d = 0.5			35	A
V_{F0}	threshold voltage	} for power loss calculation only			0.53	V
r_F	slope resistance				4.9	mΩ
R_{thJC}	thermal resistance junction to case				0.70	K/W
T_{VJ}	virtual junction temperature		-55		175	°C
P_{tot}	total power dissipation				215	W
I_{FSM}	max. forward surge current	t = 10 ms (50 Hz), sine			420	A
C_J	junction capacitance	$V_R = 24\text{ V}; f = 1\text{ MHz}$		226		pF

Symbol	Definition	Conditions	Ratings			Unit
			min.	typ.	max.	
I_{RMS}	RMS current	per terminal ¹⁾			50	A
R_{thCH}	thermal resistance case to heatsink			0.25		K/W
T_{stg}	storage temperature		-55		150	°C
Weight				6		g
M_D	mounting torque		0.8		1.2	Nm
F_C	mounting force with clip		20		120	N

¹⁾ I_{RMS} is typically limited by the pin-to-chip resistance (1); or by the current capability of the chip (2).
 In case of (1) and a common cathode/anode configuration with a non-isolated backside, the current capability can be increased by connecting the backside.

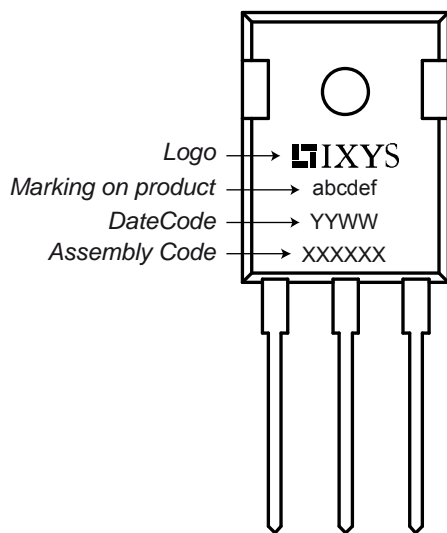
Product Marking

Part number

D = Diode
 S = Schottky Diode
 A = low VF
 70 = Current Rating [A]
 C = Common Cathode
 150 = Reverse Voltage [V]
 HB = TO-247AD (3)

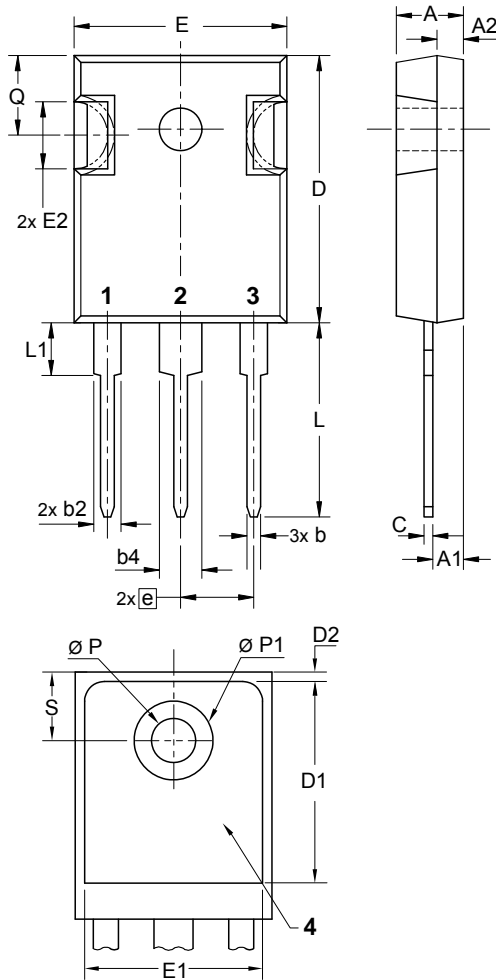
Ordering	Part Name	Marking on Product	Delivering Mode	Base Qty	Code Key
Standard	DSA 70 C 150 HB	DSA70C150HB	Tube	30	506708

Outlines TO-247

Sym.	Inches		Millimeter	
	min.	max.	min.	max.
A	0.185	0.209	4.70	5.30
A1	0.087	0.102	2.21	2.59
A2	0.059	0.098	1.50	2.49
D	0.819	0.845	20.79	21.45
E	0.610	0.640	15.48	16.24
E2	0.170	0.216	4.31	5.48
e	0.215 BSC		5.46 BSC	
L	0.780	0.800	19.80	20.30
L1	-	0.177	-	4.49
Ø P	0.140	0.144	3.55	3.65
Q	0.212	0.244	5.38	6.19
S	0.242 BSC		6.14 BSC	
b	0.039	0.055	0.99	1.40
b2	0.065	0.094	1.65	2.39
b4	0.102	0.135	2.59	3.43
c	0.015	0.035	0.38	0.89
D1	0.515	-	13.07	-
D2	0.020	0.053	0.51	1.35
E1	0.530	-	13.45	-
Ø P1	-	0.29	-	7.39

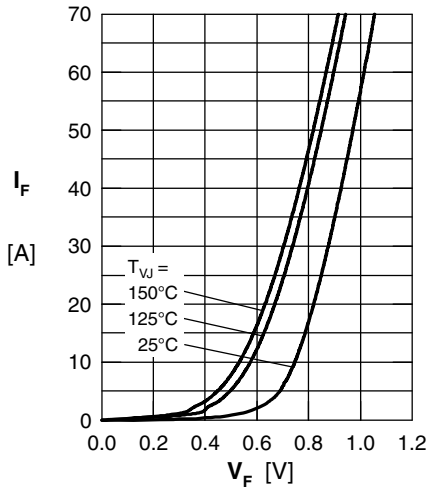

Fig. 1 Maximum forward voltage drop characteristics

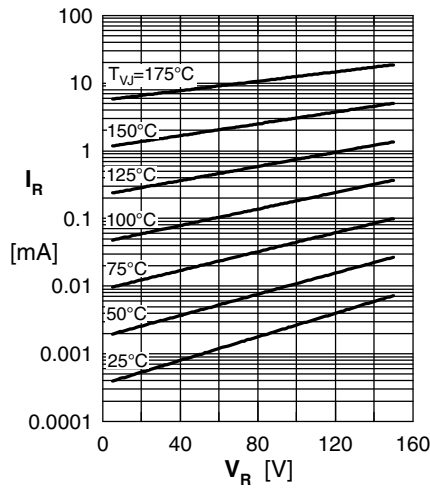

Fig. 2 Typ. reverse current I_R vs. reverse voltage V_R

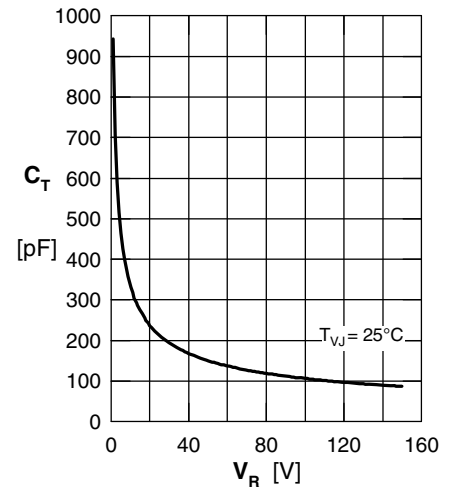

Fig. 3 Typ. junction capacitance C_T vs. reverse voltage V_R

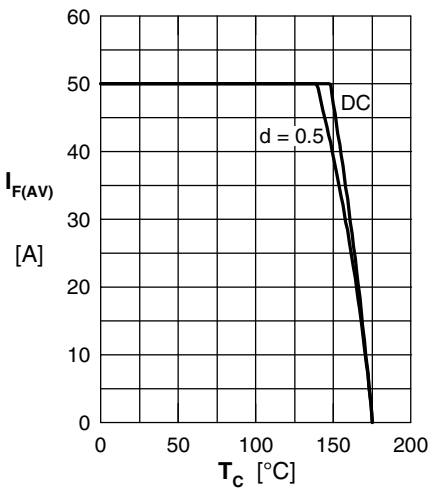

Fig. 4 Average forward current $I_{F(AV)}$ vs. case temperature T_C

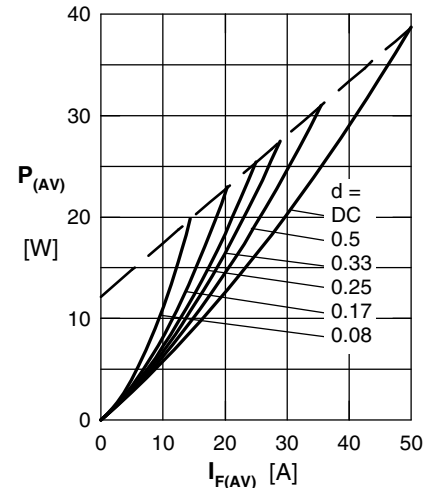

Fig. 5 Forward power loss characteristics

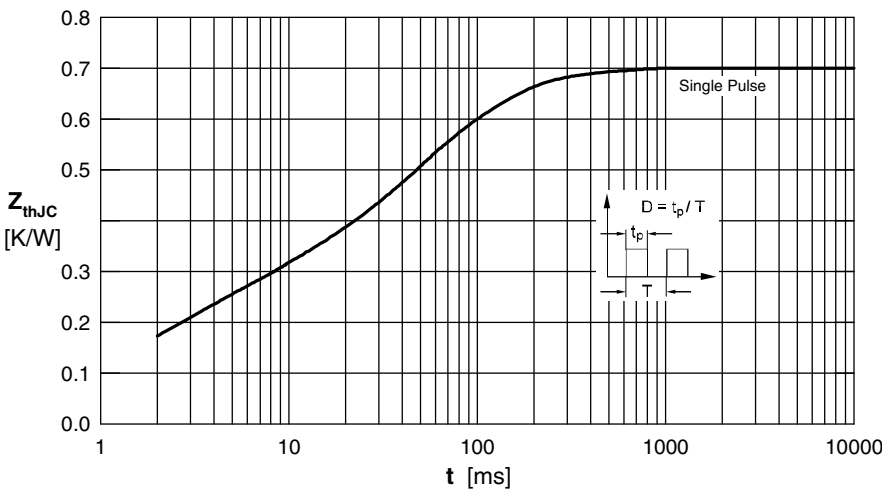

Fig. 6 Transient thermal impedance junction to case

Note: All curves are per diode