



MBR2545CT
MBRB2545CT
MBR2545CT-1

SCHOTTKY RECTIFIER

30 Amp





Major Ratings and Characteristics

| Characteristics | Values | Units |
|---|------------|------------------|
| $I_{F(AV)}$ Rectangular waveform (Per Device) | 30 | A |
| I_{FRM} @ $T_C = 130^\circ\text{C}$ (Per Leg) | 30 | A |
| V_{RRM} | 35/45 | V |
| I_{FSM} @ tp = 5 μs sine | 1060 | A |
| V_F @ 30 Apk, $T_J = 125^\circ\text{C}$ | 0.73 | V |
| T_J range | -65 to 150 | $^\circ\text{C}$ |

Description/ Features

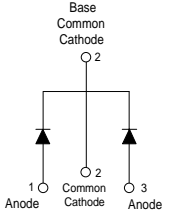
This center tap Schottky rectifier has been optimized for low reverse leakage at high temperature. The proprietary barrier technology allows for reliable operation up to 150° C junction temperature. Typical applications are in switching power supplies, converters, free-wheeling diodes, and reverse battery protection.

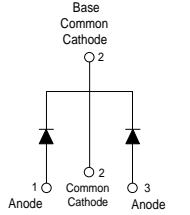
- 150° C T_J operation
- Center tap TO-220 and D²Pak packages
- Low forward voltage drop
- High purity, high temperature epoxy encapsulation for enhanced mechanical strength and moisture resistance
- High frequency operation
- Guard ring for enhanced ruggedness and long term reliability

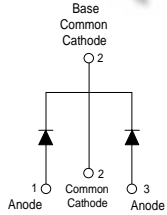
| Case Styles | | |
|--|---|--|
| <p>MBR25..CT</p>  <p>Base Common Cathode</p>  <p>TO-220</p> | <p>MBRB25..CT</p>  <p>Base Common Cathode</p>  <p>D²PAK</p> | <p>MBR25..CT-1</p>  <p>Base Common Cathode</p>  <p>TO-262</p> |

Voltage Ratings

| Parameters | MBR2535CT MBRB2535CT MBR2535CT-1 | MBR2545CT MBRB2545CT MBR2545CT-1 |
|--|--|--|
| V _R Max. DC Reverse Voltage (V) | 35 | 45 |
| V _{RWM} Max. Working Peak Reverse Voltage (V) | | |

Absolute Maximum Ratings

| Parameters | Values | Units | Conditions |
|--|--------|-------|--|
| I _{F(AV)} Max. Average Forward Current (Per Leg) (Per Device) | 15 | A | @ T _C = 130°C, (Rated V _R) |
| | 30 | | |
| I _{FRM} Peak Repetitive Forward Current (Per Leg) | 30 | A | Rated V _R , square wave, 20kHz T _C = 130°C |
| I _{FSM} Non Repetitive Peak Surge Current | 1060 | A | 5µs Sine or 3µs Rect. pulse Following any rated load condition and with rated V _{RRM} applied Surge applied at rated load conditions halfwave, single phase, 60Hz |
| | 150 | | |
| E _{AS} Non-Repetitive Avalanche Energy (Per Leg) | 16 | mJ | T _J = 25°C, I _{AS} = 2 Amps, L = 8 mH |
| I _{AR} Repetitive Avalanche Current (Per Leg) | 2 | A | Current decaying linearly to zero in 1µsec Frequency limited by T _J max. V _A = 1.5 x V _R typical |

Electrical Specifications

| Parameters | Values | Units | Conditions |
|---|--------|-------|---|
| V _{FM} Max. Forward Voltage Drop (1) | 0.82 | V | @ 30A T _J = 25°C |
| | 0.73 | V | @ 30A T _J = 125°C |
| I _{RM} Max. Instantaneous Reverse Current (1) | 0.2 | mA | T _J = 25°C |
| | 40 | mA | T _J = 125°C Rated DC voltage |
| V _{F(TO)} Threshold Voltage | 0.355 | V | T _J = T _J max. |
| r _f Forward Slope Resistance | 12.3 | mΩ | |
| C _T Max. Junction Capacitance | 700 | pF | V _R = 5V _{DC} , (test signal range 100Khz to 1Mhz) 25°C |
| L _S Typical Series Inductance | 8.0 | nH | Measured from top of terminal to mounting plane |
| dv/dt Max. Voltage Rate of Change (Rated V _R) | 10000 | V/µs | |

(1) Pulse Width < 300µs, Duty Cycle < 2%

Thermal-Mechanical Specifications

| Parameters | Values | Units | Conditions |
|--|--------------|----------------|---|
| T _J Max. Junction Temperature Range | -65 to 150 | °C | |
| T _{stg} Max. Storage Temperature Range | -65 to 175 | °C | |
| R _{thJC} Max. Thermal Resistance Junction to Case (Per Leg) | 1.5 | °C/W | DC operation |
| R _{thCS} Typical Thermal Resistance Case to Heatsink | 0.50 | °C/W | Mounting surface, smooth and greased Only for TO-220 |
| wt Approximate Weight | 2 (0.07) | g (oz.) | |
| T Mounting Torque | Min. 6 (5) | Kg-cm (lbf-in) | Non-lubricated threads |
| | Max. 12 (10) | | |

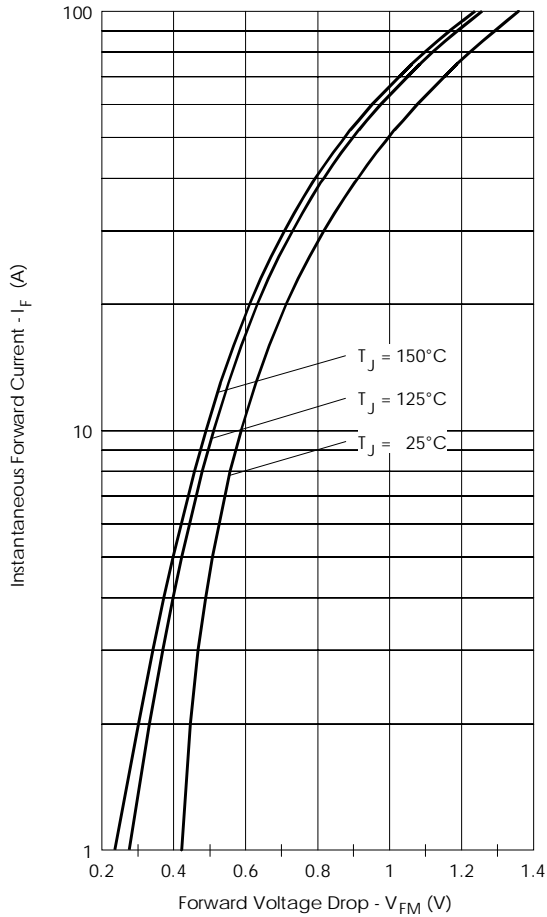

Fig. 1 - Max. Forward Voltage Drop Characteristics (Per Leg)

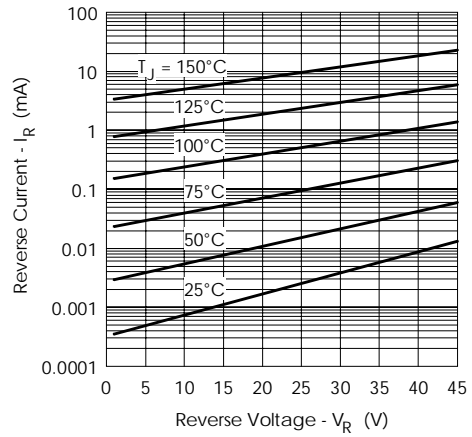

Fig. 2 - Typical Values Of Reverse Current Vs. Reverse Voltage (Per Leg)

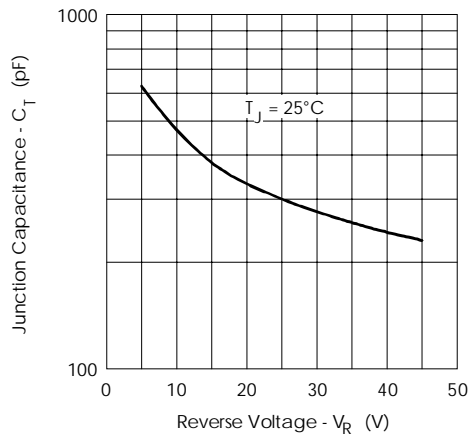

Fig. 3 - Typical Junction Capacitance Vs. Reverse Voltage (Per Leg)

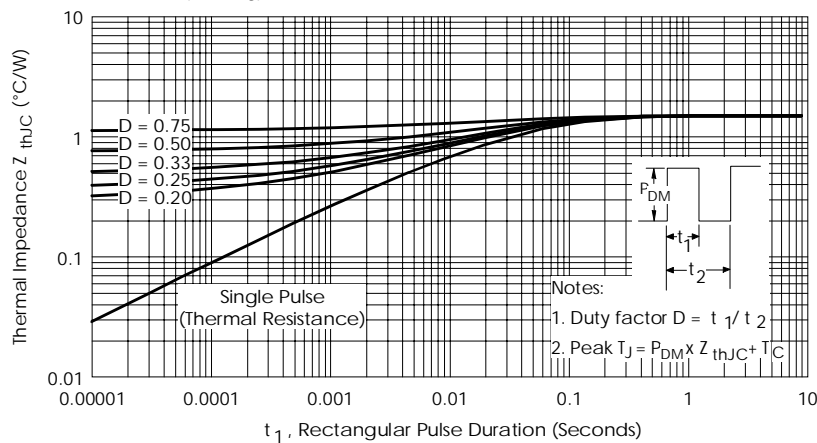

Fig. 4 - Max. Thermal Impedance Z_{thJC} Characteristics (Per Leg)

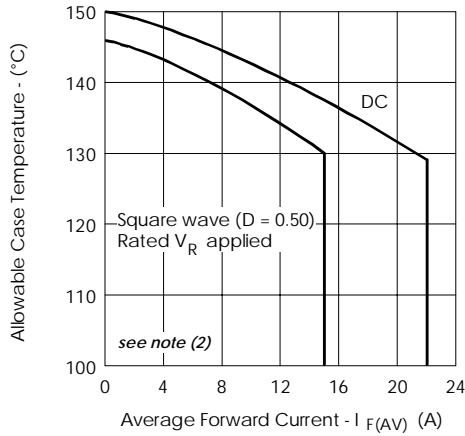

Fig. 5 - Max. Allowable Case Temperature Vs. Average Forward Current (Per Leg)

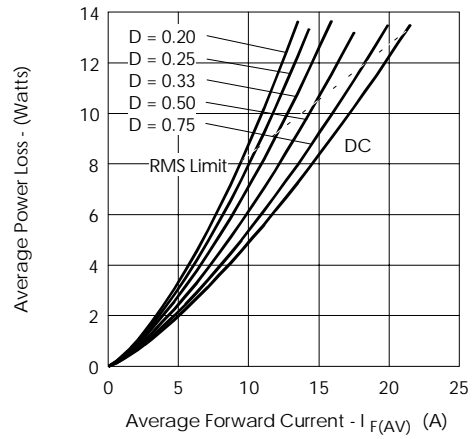

Fig. 6 - Forward Power Loss Characteristics (Per Leg)

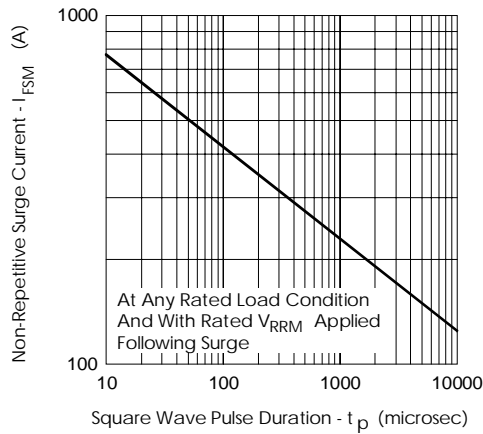

Fig. 7 - Max. Non-Repetitive Surge Current (Per Leg)

- (2) Formula used: $T_C = T_J - (Pd + Pd_{REV}) \times R_{thJC}$;
 Pd = Forward Power Loss = $I_{F(AV)} \times V_{FM}$ @ $(I_{F(AV)} / D)$ (see Fig. 6);
 Pd_{REV} = Inverse Power Loss = $V_{R1} \times I_R (1 - D)$; I_R @ V_{R1} = rated V_R

Ordering Information Table

| Device Code | | | | | |
|-------------|----------|-----------|-----------|-----------|-----------|
| 1 | 2 | 3 | 4 | 5 | 6 |
| MBR | B | 25 | 45 | CT | -1 |

- 1** - Essential Part Number
- 2** - B = Surface Mount
None = TO-220
- 3** - Current Rating
- 4** - Voltage code: Code = V_{RRM}

| | |
|----|-------|
| 35 | = 35V |
| 45 | = 45V |
- 5** - CT= Essential Part Number
- 6** - -1 = TO-262
None = TO-220

Outline Table

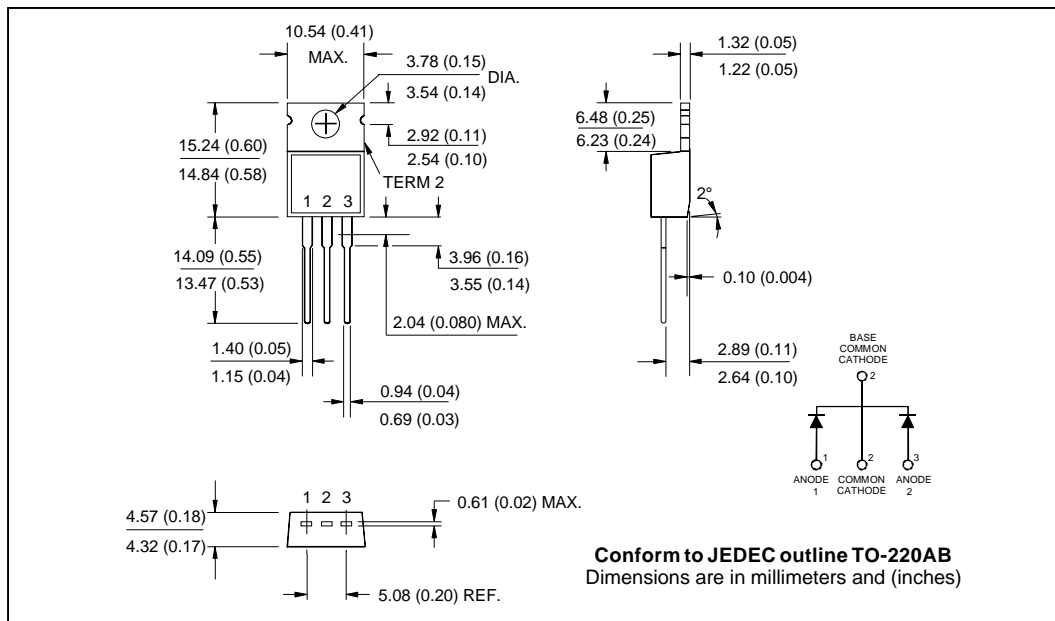

Outline Table

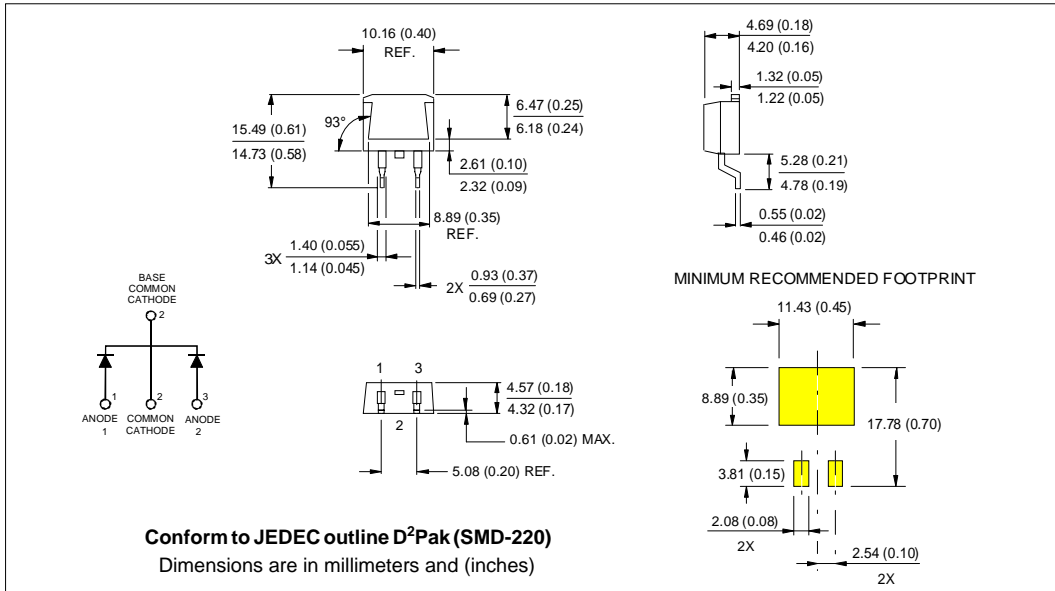

Tape & Reel Information

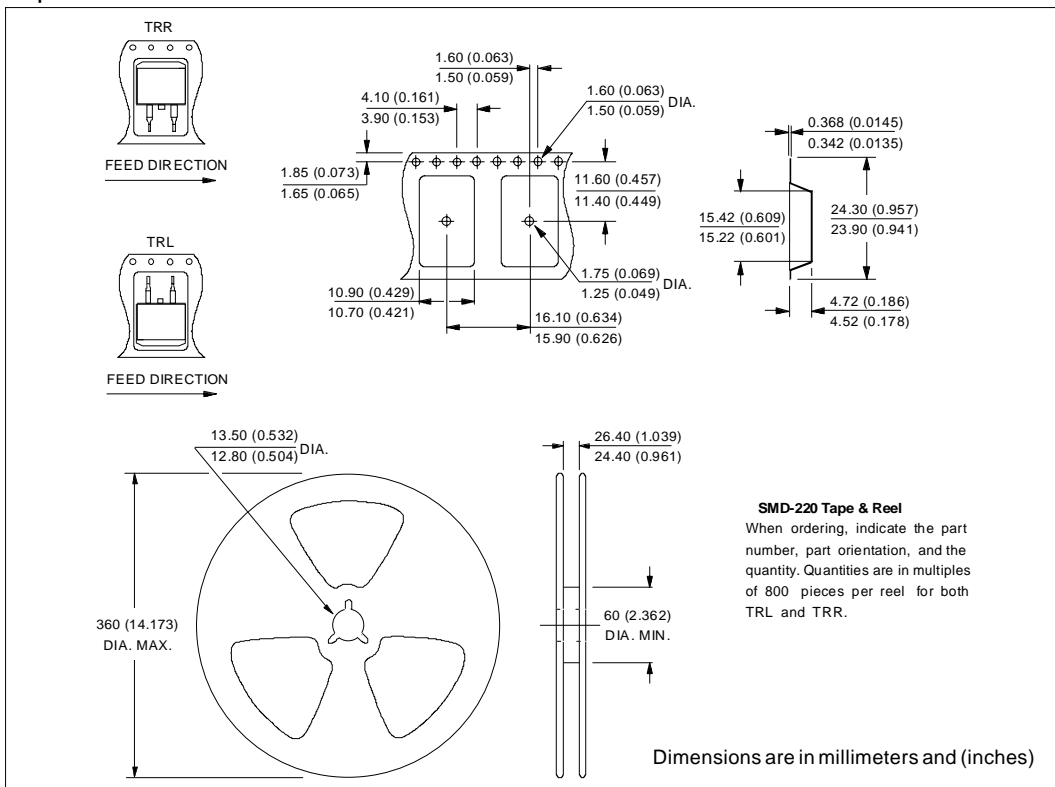

Outline Table

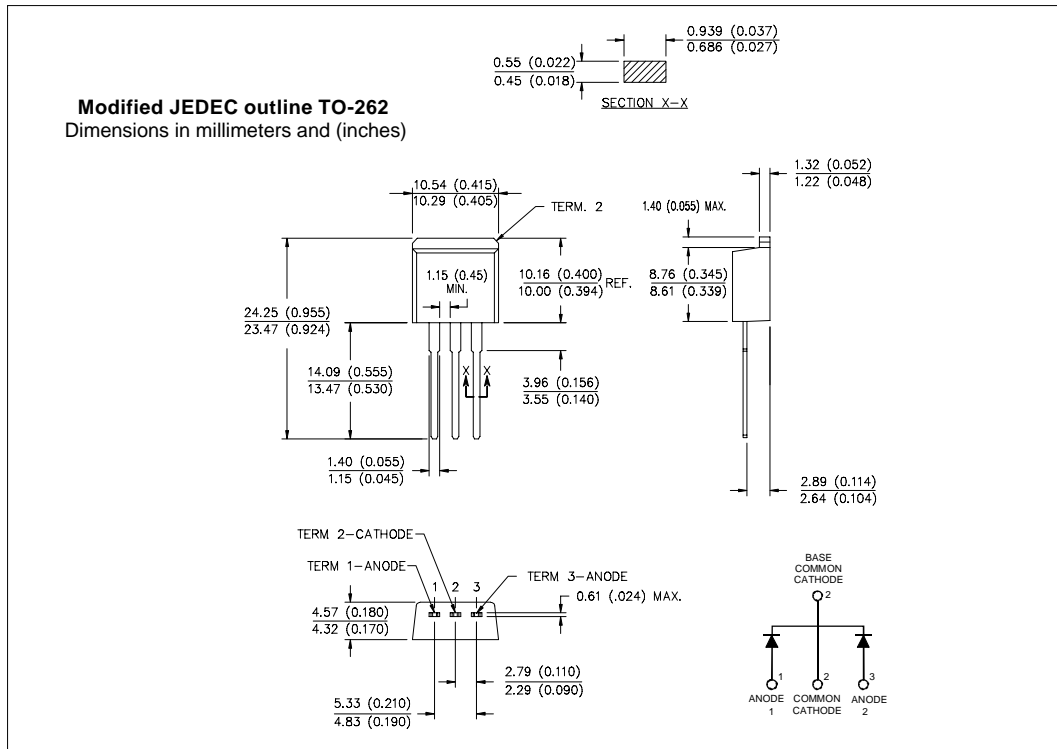

Data and specifications subject to change without notice.
This product has been designed and qualified for Industrial Level.
Qualification Standards can be found on IR's Web site.