

# HLMP-4700

T-1<sup>3/4</sup> (5 mm), T-1 (3 mm), Low Current LED Lamps



## Data Sheet



HLMP-4700, HLMP-4719, HLMP-4740  
HLMP-1700, HLMP-1719, HLMP-1790

### Description

These tinted diffused LED lamps are designed and optimized specifically for low DC current operation. Luminous intensity and forward voltage are tested at 2 mA to assure consistent brightness at TTL output current levels.

### Applications

- Low power DC circuits
- Telecommunications indicators
- Portable equipment
- Keyboard indicators

### Features

- Low power
- High efficiency
- CMOS-MOS compatible
- TTL compatible
- Wide viewing angle
- Choice of package styles
- Choice of colors

### Package Dimensions

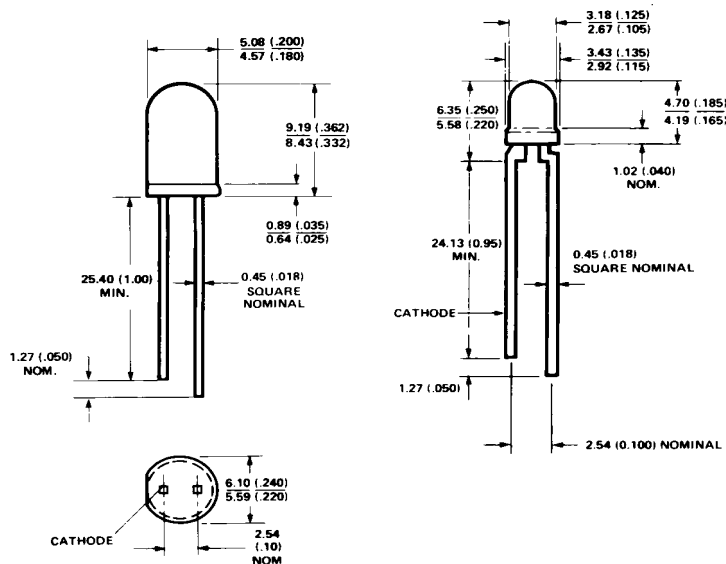

HLMP-4700, -4719, -4740

A

HLMP-1700, -1719, -1790

B

### NOTES:

1. ALL DIMENSIONS ARE IN MILLIMETERS (INCHES).
2. AN EPOXY MINISCUS MAY EXTEND ABOUT 1 mm (0.040") DOWN THE LEADS.

## Selection Guide

Package Description	Color	Device HLMP-	Luminous Intensity I <sub>v</sub> (mcd) at 2 mA			2θ <sup>1/2</sup>	Package Outline
			Min.	Typ.	Max.		
T-1 3/4 Tinted Diffused	Red	4700	1.5	2.3	–	50	A
		4700-C00xx	1.5	2.3	–		
		4700-CD0FH	1.5	2.3	4.2		
	Yellow	4719	0.9	2.1	–		
		4719-A00xx	0.9	2.1	–		
	Green	4740	1.0	2.3	–		
		4740-A00xx	1.0	2.3	–		
		4740-AB000	1.0	2.3	3.2		
	T-1 Tinted Diffused	Red	1700	0.8	2.1		
1700-B00xx			0.8	2.1	–		
Yellow		1719	0.9	2.1	–		
		1719-A00xx	0.9	2.1	–		
		1719-ABB00	0.9	2.1	2.8		
Green		1790	1.0	2.3	–		
		1790-A00xx	1.0	2.3	–		
		1790-AB0FH	1.0	2.4	3.2		

**Note:**

1. θ<sup>1/2</sup> is the typical off-axis angle at which the luminous intensity is half the axial luminous intensity.

## Part Numbering System

HLMP-X 7 XX - X X X XX

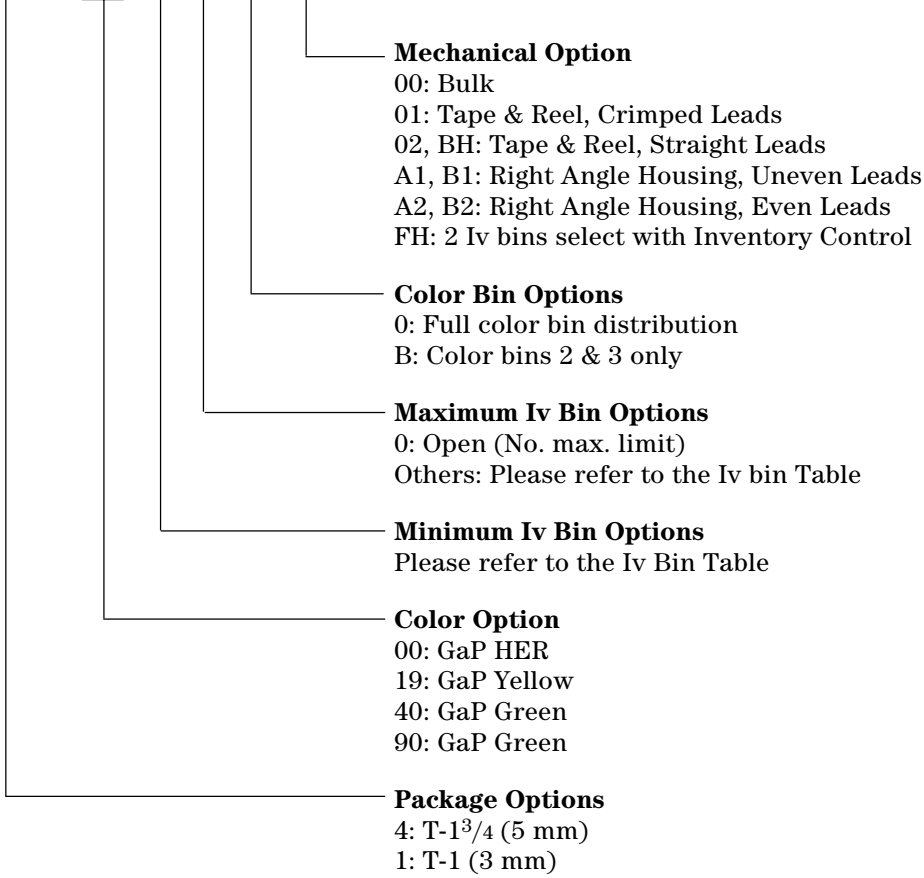

Electrical/Optical Characteristics at  $T_A = 25^\circ\text{C}$

Symbol	Description	T-1 <sup>3/4</sup>	T-1	Min.	Typ.	Max.	Units	Test Conditions
$V_F$	Forward Voltage	4700	1700		1.7	2.0	V	2 mA
		4719	1719		1.8	2.5		
		4740	1790		1.9	2.2		
$V_R$	Reverse Breakdown Voltage	4700	1700	5.0			V	$I_R = 50 \mu\text{A}$
		4719	1719	5.0				
		4740	1790	5.0				
$\lambda_d$	Dominant Wavelength	4700	1700		626		nm	Note 1
		4719	1719		585			
		4740	1790		569			
$\Delta\lambda_{1/2}$	Spectral Line Halfwidth	4700	1700		40		nm	
		4719	1719		36			
		4740	1790		28			
$\tau_S$	Speed of Response	4700	1700		90		ns	
		4719	1719		90			
		4740	1790		500			
C	Capacitance	4700	1700		11		pF	$V_F = 0,$ $f = 1 \text{ MHz}$
		4719	1719		15			
		4740	1790		18			
$R\theta_{J-PIN}$	Thermal Resistance	4700	1700		260 <sup>[3]</sup>		$^\circ\text{C/W}$	Junction to Cathode Lead
		4719	1719		290 <sup>[4]</sup>			
		4740	1790					
$\lambda_{PEAK}$	Peak Wavelength	4700	1700		635		nm	Measurement at Peak
		4719	1719		583			
		4740	1790		565			
$\eta_V$	Luminous Efficacy	4700	1700		145		$\frac{\text{lumens}}{\text{watt}}$	Note 2
		4719	1719		500			
		4740	1790		595			

Notes:

1. The dominant wavelength,  $\lambda_d$ , is derived from the CIE chromaticity diagram and represents the single wavelength which defines the color of the device.
2. The radiant intensity,  $I_e$ , in watts per steradian, may be found from the equation  $I_e = I_v/\eta_V$ , where  $I_v$  is the luminous intensity in candelas and  $\eta_V$  is luminous efficacy in lumens/watt.
3. T-1<sup>3/4</sup>.
4. T-1.

### Absolute Maximum Ratings

Parameter	Maximum Rating		Units
Power Dissipation (Derate linearly from 92°C at 1.0 mA/°C)	Red	2	mW
	Yellow	36	
	Green	24	
DC and Peak Forward Current	7		mA
Transient Forward Current (10 μs Pulse) <sup>[1]</sup>	500		mA
Reverse Voltage (I <sub>R</sub> = 50 μA)	5.0		V
Operating Temperature Range	Red/Yellow	-55°C to 100°C	
	Green	-20°C to 100°C	
Storage Temperature Range	-55°C to +100°C		

**Note:**

1. The transient peak current is the maximum non-recurring peak current the devices can withstand without damaging the LED die and wire bonds. It is not recommended that the device be operated at peak currents beyond the Absolute Maximum Peak Forward Current.

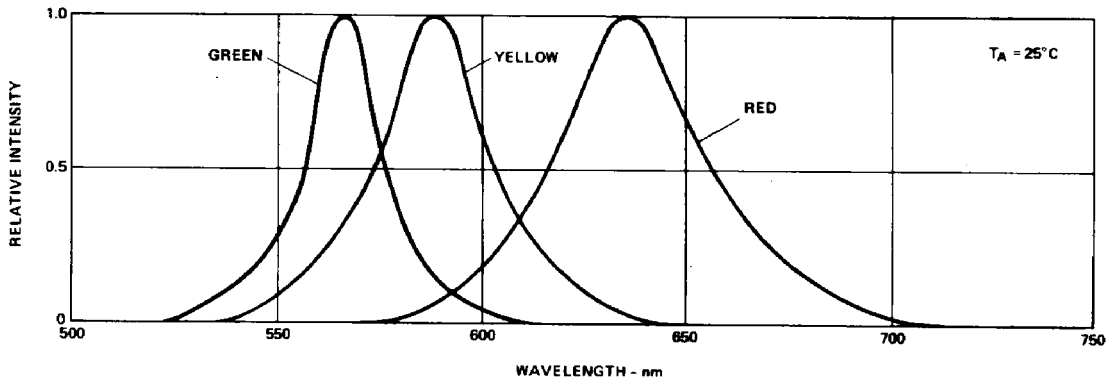

Figure 1. Relative intensity vs. wavelength.

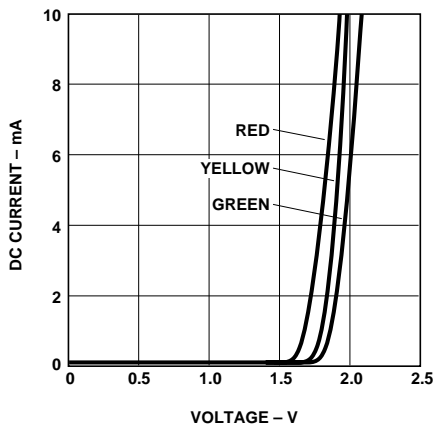

Figure 2. Forward current vs. forward voltage.

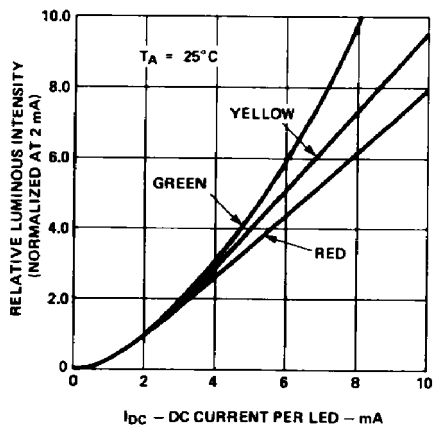

Figure 3. Relative luminous intensity vs. forward current.

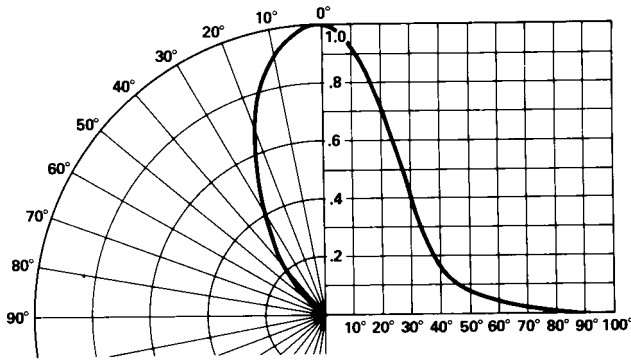

Figure 4. Relative luminous intensity vs. angular displacement for T-1<sup>3/4</sup> lamp.

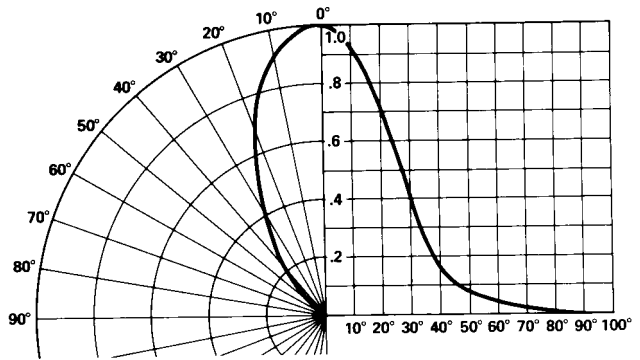

Figure 5. Relative Illuminous intensity vs. angular displacement for T-1 lamp.

### Intensity Bin Limits

Color	Bin	Intensity Range (mcd)	
		Min.	Max.
Red	B	0.9	1.5
	C	1.5	2.4
	D	2.4	3.8
	E	3.8	6.1
	F	6.1	9.7
	G	9.7	15.5
	H	15.5	24.8
	I	24.8	39.6
	J	39.6	63.4
	K	63.4	101.5
	L	101.5	162.4
	M	162.4	234.6
	N	234.6	340.0
	O	340.0	540.0
	P	540.0	850.0
	Q	850.0	1200.0
	R	1200.0	1700.0
	S	1700.0	2400.0
	T	2400.0	3400.0
	U	3400.0	4900.0
V	4900.0	7100.0	
W	7100.0	10200.0	
X	10200.0	14800.0	
Y	14800.0	21400.0	
Z	21400.0	30900.0	

Maximum tolerance for each bin limit is ±18%.

**Intensity Bin Limits, continued**

Color	Bin	Intensity Range (mcd)	
		Min.	Max.
Yellow	A	1.0	1.6
	B	1.6	2.5
	C	2.5	4.0
	D	4.0	6.5
	E	6.5	10.3
	F	10.3	16.6
	G	16.6	26.5
	H	26.5	42.3
	I	42.3	67.7
	J	67.7	108.2
	K	108.2	173.2
	L	173.2	250.0
	M	250.0	360.0
	N	360.0	510.0
	O	510.0	800.0
	P	800.0	1250.0
	Q	1250.0	1800.0
R	1800.0	2900.0	
S	2900.0	4700.0	
T	4700.0	7200.0	
U	7200.0	11700.0	
V	11700.0	18000.0	
W	18000.0	27000.0	

Maximum tolerance for each bin limit is  $\pm 18\%$ .

**Intensity Bin Limits, continued**

Color	Bin	Intensity Range (mcd)	
		Min.	Max.
Green	A	1.1	1.8
	B	1.8	2.9
	C	2.9	4.7
	D	4.7	7.6
	E	7.6	12.0
	F	12.0	19.1
	G	19.1	30.7
	H	30.7	49.1
	I	49.1	78.5
	J	78.5	125.7
	K	125.7	201.1
	L	201.1	289.0
	M	289.0	417.0
	N	417.0	680.0
	O	680.0	1100.0
	P	1100.0	1800.0
	Q	1800.0	2700.0
	R	2700.0	4300.0
	S	4300.0	6800.0
T	6800.0	10800.0	
U	10800.0	16000.0	
V	16000.0	25000.0	
W	25000.0	40000.0	

Maximum tolerance for each bin limit is  $\pm 18\%$ .



## Color Categories

Color	Category #	Lambda (nm)	
		Min.	Max.
Green	6	561.5	564.5
	5	564.5	567.5
	4	567.5	570.5
	3	570.5	573.5
	2	573.5	576.5
Yellow	1	582.0	584.5
	3	584.5	587.0
	2	587.0	589.5
	4	589.5	592.0
	5	592.0	593.0

Tolerance for each bin limit is  $\pm 0.5$  nm.

## Mechanical Option Matrix

Mechanical Option Code	Definition
00	Bulk Packaging, minimum increment 500 pcs/bag
01	Tape & Reel, crimped leads, min. increment 1300 pcs/bag for T-1 3/4, 1800 pcs/bag for T-1
02	Tape & Reel, straight leads, min. increment 1300 pcs/bag for T-1 3/4, 1800 pcs/bag for T-1
A1	T-1, Right Angle Housing, uneven leads, minimum increment 500 pcs/bag
A2	T-1, Right Angle Housing, even leads, minimum increment 500 pcs/bag
B1	T-1 3/4, Right Angle Housing, uneven leads, minimum increment 500 pcs/bag
B2	T-1 3/4, Right Angle Housing, even leads, minimum increment 500 pcs/bag
BH	T-1, Tape & Reel, straight leads, minimum increment 2000 pcs/bag
FH	Devices that require inventory control and 2 I <sub>v</sub> bin select
R1	Tape & Reel, crimped leads, reeled counter clockwise, cathode lead leaving the reel first

### Note:

All categories are established for classification of products. Products may not be available in all categories. Please contact your local Avago representative for further clarification/information.

**Precautions**

**Lead Forming**

- The leads of an LED lamp may be preformed or cut to length prior to insertion and soldering into PC board.
- If lead forming is required before soldering, care must be taken to avoid any excessive mechanical stress induced to LED package. Otherwise, cut the leads of LED to length after soldering process at room temperature. The solder joint formed will absorb the mechanical stress of the lead cutting from traveling to the LED chip die attach and wirebond.
- It is recommended that tooling made to precisely form and cut the leads to length rather than rely upon hand operation.

**Soldering Conditions**

- Care must be taken during PCB assembly and soldering process to prevent damage to LED component.
- The closest LED is allowed to solder on board is 1.59 mm below the body (encapsulant epoxy) for those parts without standoff.
- Recommended soldering conditions:

	Wave Soldering	Manual Solder Dipping
Pre-heat Temperature	105 °C Max.	–
Pre-heat Time	30 sec Max.	–
Peak Temperature	250 °C Max.	260 °C Max.
Dwell Time	3 sec Max.	5 sec Max.

- Wave soldering parameter must be set and maintained according to recommended temperature and dwell time in the solder wave. Customer is advised to periodically check on the soldering profile to ensure the soldering profile used is always conforming to recommended soldering condition.
- If necessary, use fixture to hold the LED component in proper orientation with respect to the PCB during soldering process.
- Proper handling is imperative to avoid excessive thermal stresses to LED components when heated. Therefore, the soldered PCB must be allowed to cool to room temperature, 25°C, before handling.
- Special attention must be given to board fabrication, solder masking, surface plating and lead holes size and component orientation to assure solderability.
- Recommended PC board plated through hole sizes for LED component leads:

LED Component Lead Size	Diagonal	Plated Through Hole Diameter
0.457 x 0.457 mm (0.018 x 0.018 inch)	0.646 mm (0.025 inch)	0.976 to 1.078 mm (0.038 to 0.042 inch)
0.508 x 0.508 mm (0.020 x 0.020 inch)	0.718 mm (0.028 inch)	1.049 to 1.150 mm (0.041 to 0.045 inch)

**Note:** Refer to application note AN1027 for more information on soldering LED components.

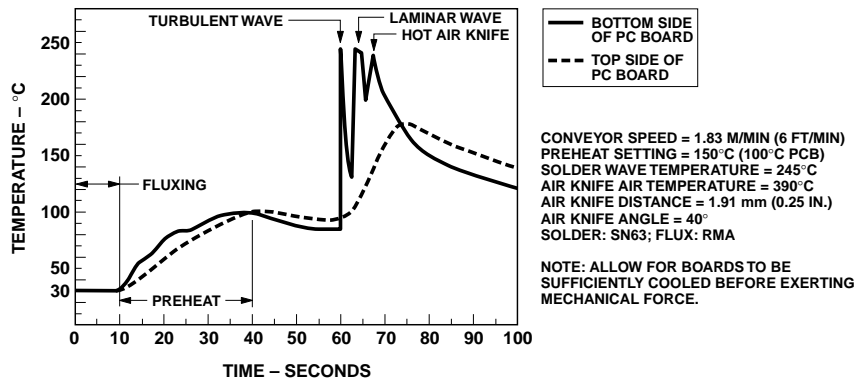

Figure 6. Recommended wave soldering profile.

For product information and a complete list of distributors, please go to our website: [www.avagotech.com](http://www.avagotech.com)

Avago, Avago Technologies, and the A logo are trademarks of Avago Technologies Limited in the United States and other countries.  
Data subject to change. Copyright © 2006 Avago Technologies Limited. All rights reserved. Obsoletes 5989-2812EN  
5989-4256EN June 7, 2006

