

Silicon Epitaxial Planar Z-Diodes

Features

- Sharp edge in reverse characteristics
- Low reverse current
- Low noise
- Very high stability
- Available with tighter tolerances

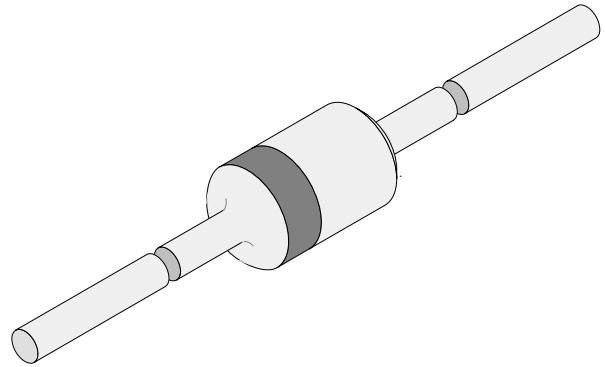

Applications

Voltage stabilization

94 9369

Absolute Maximum Ratings

$T_j = 25^\circ\text{C}$

Parameter	Test Conditions	Type	Symbol	Value	Unit
Power dissipation	$l=4\text{mm}, T_L=25^\circ\text{C}$		P_V	1.3	W
Junction temperature			T_j	175	$^\circ\text{C}$
Storage temperature range			T_{stg}	-65...+175	$^\circ\text{C}$

Maximum Thermal Resistance

$T_j = 25^\circ\text{C}$

Parameter	Test Conditions	Symbol	Value	Unit
Junction ambient	$l=4\text{mm}, T_L=\text{constant}$	R_{thJA}	110	K/W

Characteristics

$T_j = 25^\circ\text{C}$

Parameter	Test Conditions	Type	Symbol	Min	Typ	Max	Unit
Forward voltage	$I_F=200\text{mA}$		V_F			1	V

Type BZX85C...	V _{Znom} V	I _{ZT} mA	for V _{ZT} ¹⁾ V	and r _{zjT} Ω	r _{zjk} Ω	at I _{ZK} mA	I _R μA	at V _R V	TK _{VZ} %/K
2V7	2.7	80	2.5 to 2.9	< 20	< 400	1	< 150	1	-0.08 to -0.05
3V0	3.0	80	2.8 to 3.2	< 20	< 400	1	< 100	1	-0.08 to -0.05
3V3	3.3	80	3.1 to 3.5	< 20	< 400	1	< 40	1	-0.08 to -0.05
3V6	3.6	60	3.4 to 3.8	< 20	< 500	1	< 20	1	-0.08 to -0.05
3V9	3.9	60	3.7 to 4.1	< 15	< 500	1	< 10	1	-0.07 to -0.02
4V3	4.3	50	4.0 to 4.6	< 13	< 500	1	< 3	1	-0.07 to -0.01
4V7	4.7	45	4.4 to 5.0	< 13	< 600	1	< 3	1	-0.03 to +0.04
5V1	5.1	45	4.8 to 5.4	< 10	< 500	1	< 1	1.5	-0.01 to +0.04
5V6	5.6	45	5.2 to 6.0	< 7	< 400	1	< 1	2	0 to +0.045
6V2	6.2	35	5.8 to 6.6	< 4	< 300	1	< 1	3	+0.01 to +0.055
6V8	6.8	35	6.4 to 7.2	< 3.5	< 300	1	< 1	4	+0.015 to +0.06
7V5	7.5	35	7.0 to 7.9	< 3	< 200	0.5	< 1	4.5	+0.02 to +0.065
8V2	8.2	25	7.7 to 8.7	< 5	< 200	0.5	< 1	6.2	0.03 to 0.07
9V1	9.1	25	8.5 to 9.6	< 5	< 200	0.5	< 1	6.8	0.035 to 0.075
10	10	25	9.4 to 10.6	< 7	< 200	0.5	< 0.5	7	0.04 to 0.08
11	11	20	10.4 to 11.6	< 8	< 300	0.5	< 0.5	8.2	0.045 to 0.08
12	12	20	11.4 to 12.7	< 9	< 350	0.5	< 0.5	9.1	0.045 to 0.085
13	13	20	12.4 to 14.1	< 10	< 400	0.5	< 0.5	10	0.05 to 0.085
15	15	15	13.8 to 15.6	< 15	< 500	0.5	< 0.5	11	0.055 to 0.09
16	16	15	15.3 to 17.1	< 15	< 500	0.5	< 0.5	12	0.055 to 0.09
18	18	15	16.8 to 19.1	< 20	< 500	0.5	< 0.5	13	0.06 to 0.09
20	20	10	18.8 to 21.2	< 24	< 600	0.5	< 0.5	15	0.06 to 0.09
22	22	10	20.8 to 23.3	< 25	< 600	0.5	< 0.5	16	0.06 to 0.095
24	24	10	22.8 to 25.6	< 25	< 600	0.5	< 0.5	18	0.06 to 0.095
27	27	8	25.1 to 28.9	< 30	< 750	0.25	< 0.5	20	0.06 to 0.095
30	30	8	28 to 32	< 30	< 1000	0.25	< 0.5	22	0.06 to 0.095
33	33	8	31 to 35	< 35	< 1000	0.25	< 0.5	24	0.06 to 0.095
36	36	8	34 to 38	< 40	< 1000	0.25	< 0.5	27	0.06 to 0.095
39	39	6	37 to 41	< 50	< 1000	0.25	< 0.5	30	0.06 to 0.095
43	43	6	40 to 46	< 50	< 1000	0.25	< 0.5	33	0.06 to 0.095
47	47	4	44 to 50	< 90	< 1500	0.25	< 0.5	36	0.06 to 0.095
51	51	4	48 to 54	< 115	< 1500	0.25	< 0.5	39	0.06 to 0.095
56	56	4	52 to 60	< 120	< 2000	0.25	< 0.5	43	0.06 to 0.095
62	62	4	58 to 66	< 125	< 2000	0.25	< 0.5	47	0.06 to 0.095
68	68	4	64 to 72	< 130	< 2000	0.25	< 0.5	51	0.06 to 0.095
75	75	4	70 to 79	< 135	< 2000	0.25	< 0.5	56	0.06 to 0.095

1) Tighter tolerances available on request:
BZX85B... ± 2% of V_{Znom}

Typical Characteristics ($T_j = 25^\circ\text{C}$ unless otherwise specified)

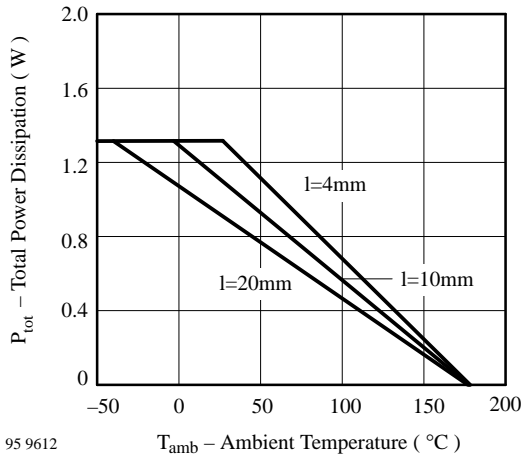

Figure 1. Total Power Dissipation vs. Ambient Temperature

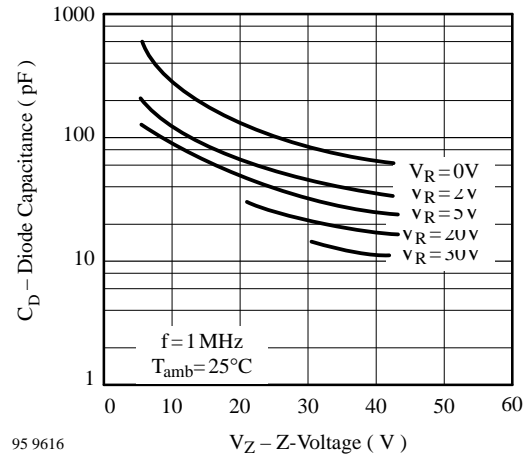

Figure 3. Diode Capacitance vs. Z-Voltage

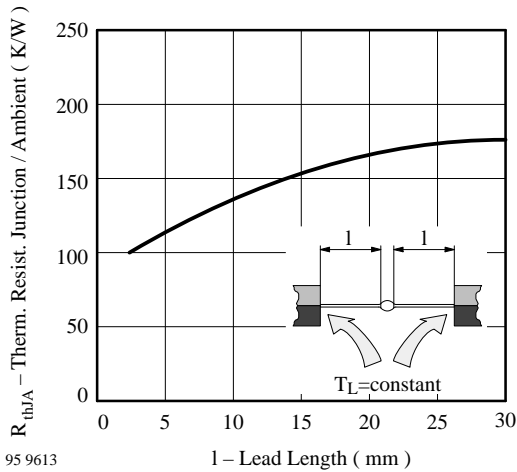

Figure 2. Thermal Resistance vs. Lead Length

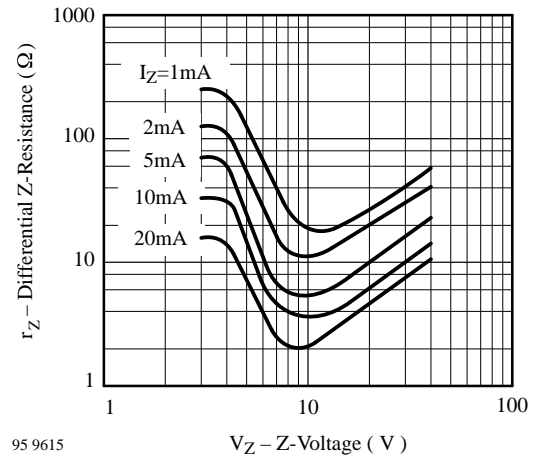

Figure 4. Differential Z-Resistance vs. Z-Voltage

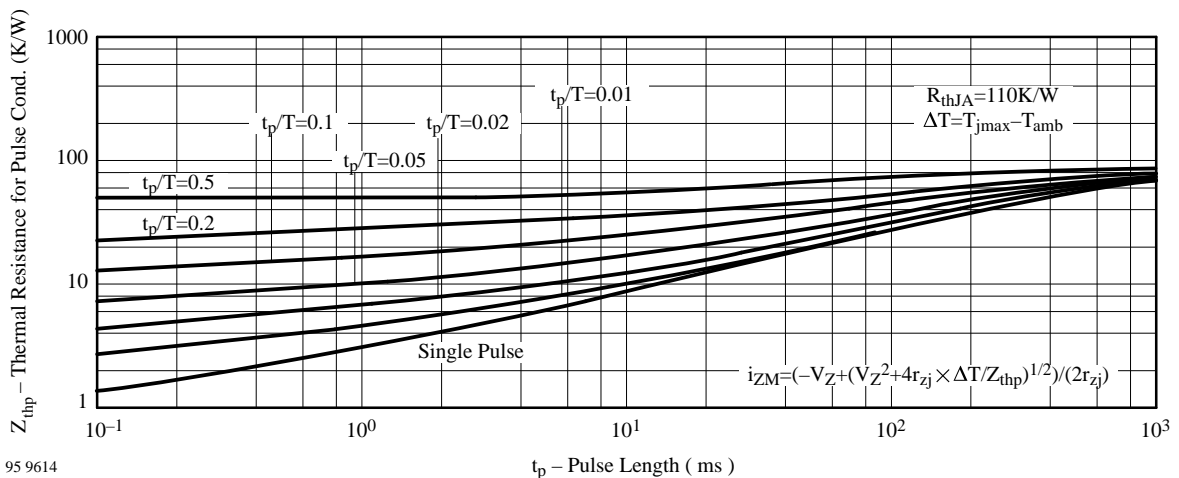
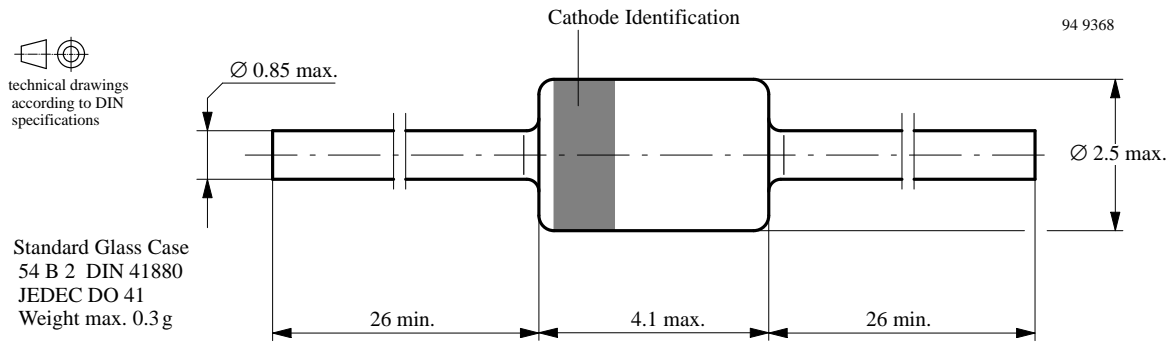

Figure 5. Thermal Response

Dimensions in mm



Ozone Depleting Substances Policy Statement

It is the policy of **TEMIC TELEFUNKEN microelectronic GmbH** to

1. Meet all present and future national and international statutory requirements.
2. Regularly and continuously improve the performance of our products, processes, distribution and operating systems with respect to their impact on the health and safety of our employees and the public, as well as their impact on the environment.

It is particular concern to control or eliminate releases of those substances into the atmosphere which are known as ozone depleting substances (ODSs).

The Montreal Protocol (1987) and its London Amendments (1990) intend to severely restrict the use of ODSs and forbid their use within the next ten years. Various national and international initiatives are pressing for an earlier ban on these substances.

TEMIC TELEFUNKEN microelectronic GmbH semiconductor division has been able to use its policy of continuous improvements to eliminate the use of ODSs listed in the following documents.

1. Annex A, B and list of transitional substances of the Montreal Protocol and the London Amendments respectively
2. Class I and II ozone depleting substances in the Clean Air Act Amendments of 1990 by the Environmental Protection Agency (EPA) in the USA
3. Council Decision 88/540/EEC and 91/690/EEC Annex A, B and C (transitional substances) respectively.

TEMIC can certify that our semiconductors are not manufactured with ozone depleting substances and do not contain such substances.

We reserve the right to make changes to improve technical design and may do so without further notice.

Parameters can vary in different applications. All operating parameters must be validated for each customer application by the customer. Should the buyer use TEMIC products for any unintended or unauthorized application, the buyer shall indemnify TEMIC against all claims, costs, damages, and expenses, arising out of, directly or indirectly, any claim of personal damage, injury or death associated with such unintended or unauthorized use.

TEMIC TELEFUNKEN microelectronic GmbH, P.O.B. 3535, D-74025 Heilbronn, Germany
Telephone: 49 (0)7131 67 2831, Fax number: 49 (0)7131 67 2423