

HLMP-Cx1A/1B/2A/2B/3A/3B

New 5mm Blue and Green LED Lamps



Data Sheet



Description

These high intensity blue and green T-1 $\frac{3}{4}$ package LEDs are untinted and non-diffused. Based on the most efficient and cost effective InGaN material technology and incorporating second generation optics they produce well defined spatial radiation patterns at specific viewing cone angles.

Advanced optical grade epoxy construction offers superior high temperature and moisture resistance performance in outdoor signal and sign applications.

Features

- Well defined spatial radiation pattern
- High luminous output
- Untinted, Non-diffused
- Available in Color:
 - Blue 470nm
 - Green 525nm
- Viewing Angle: 15°, 23° and 30°
- Standoff or non-standoff
- Superior resistance to moisture

Applications

- Commercial outdoor advertising
- Traffic Sign
- Variable Message Sign

CAUTION: InGaN devices are Class 1C HBM ESD sensitive per JEDEC Standard. Please observe appropriate precautions during handling and processing. Refer to Application Note AN – 1142 for additional details.

Device Selection Guide

Part Number	Color	Typical Viewing angle, $2\theta_{1/2}$ (°) [4]	Luminous Intensity I_v (mcd) at 20 mA [1,2,5]		Standoff / Non Standoff	Package drawing
			Min	Max		
HLMP-CB1A-XY0DD	Blue	15°	7200	12000	Non Standoff	A
HLMP-CB1A-XYBDD						
HLMP-CB1A-XYCDD						
HLMP-CB1B-XY0DD					Standoff	B
HLMP-CB1B-XYBDD						
HLMP-CB1B-XYCDD						
HLMP-CB2A-VW0DD		23°	4200	7200	Non Standoff	A
HLMP-CB2A-VWBDD						
HLMP-CB2A-VWCDD						
HLMP-CB2B-VW0DD					Standoff	B
HLMP-CB2B-VWBDD						
HLMP-CB2B-VWCDD						
HLMP-CB3A-UV0DD		30°	3200	5500	Non Standoff	A
HLMP-CB3A-UVBDD						
HLMP-CB3A-UVCDD						
HLMP-CB3B-UV0DD					Standoff	B
HLMP-CB3B-UVBDD						
HLMP-CB3B-UVCDD						
HLMP-CM1A-450DD	Green	15°	35000	59000	Non Standoff	A
HLMP-CM1A-45BDD						
HLMP-CM1A-45CDD						
HLMP-CM1B-450DD					Standoff	B
HLMP-CM1B-45BDD						
HLMP-CM1B-45CDD						
HLMP-CM2A-120DD		23°	16000	27000	Non Standoff	A
HLMP-CM2A-12BDD						
HLMP-CM2A-12CDD						
HLMP-CM2B-120DD					Standoff	B
HLMP-CM2B-12BDD						
HLMP-CM2B-12CDD						
HLMP-CM3A-Z10DD		30°	12000	21000	Non Standoff	A
HLMP-CM3A-Z1BDD						
HLMP-CM3A-Z1CDD						
HLMP-CM3B-Z10DD					Standoff	B
HLMP-CM3B-Z1BDD						
HLMP-CM3B-Z1CDD						

Notes:

1. The luminous intensity is measured on the mechanical axis of the lamp package and it is tested with pulsing condition.
2. The optical axis is closely aligned with the package mechanical axis.
3. Dominant wavelength, λ_d , is derived from the CIE Chromaticity Diagram and represents the color of the lamp.
4. $\theta_{1/2}$ is the off-axis angle where the luminous intensity is half the on-axis intensity.
5. Tolerance for each bin limit is $\pm 15\%$

Part Numbering System

HLMP - C x xx - x x x xx

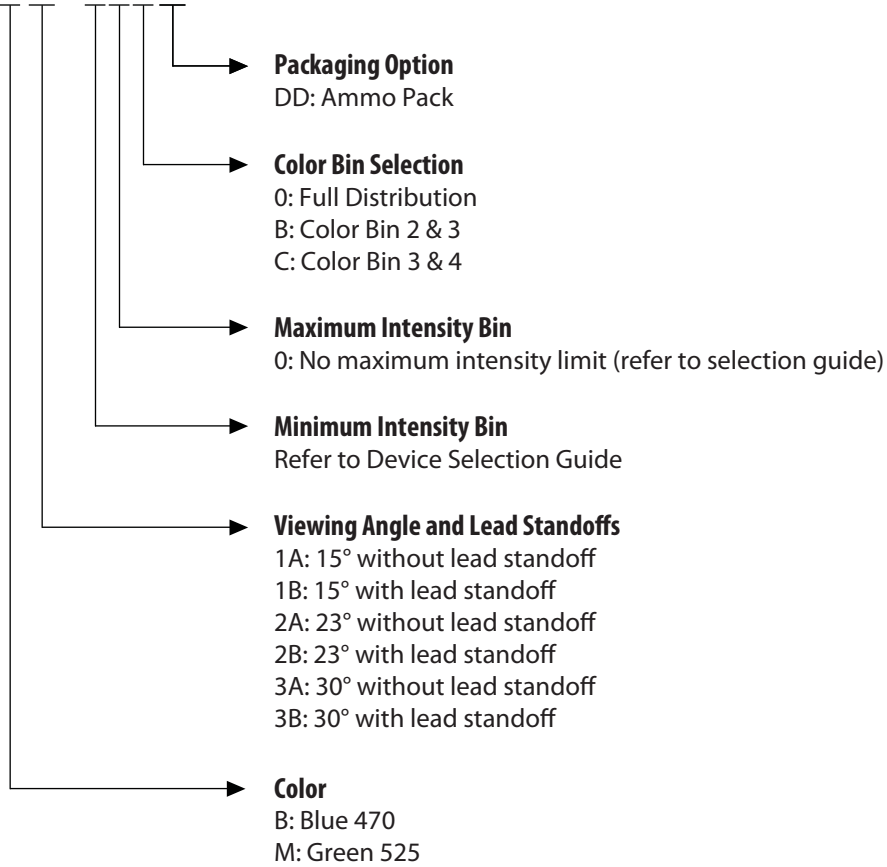

Note: please refer to AB 5337 for complete information on part numbering system

Absolute Maximum Ratings

$T_J = 25^\circ\text{C}$

Parameter	Blue / Green	Unit
DC Forward Current ^[1]	30	mA
Peak Forward Current	100 ^[2]	mA
Power Dissipation	116	mW
Reverse Voltage	5	V
LED Junction Temperature	110	°C
Operating Temperature Range	-40 to + 85	°C
Storage Temperature Range	-40 to + 100	°C

Notes:

1. Derate linearly as shown in figure 4.
2. Duty Factor 10%, frequency 1KHz.

Electrical / Optical Characteristics

$T_J = 25^\circ\text{C}$

Parameter	Symbol	Min.	Typ.	Max.	Units	Test Conditions
Forward Voltage Green / Blue	V_F	2.8	3.2	3.8	V	$I_F = 20\text{ mA}$
Reverse Voltage	V_R	5			V	$I_R = 10\ \mu\text{A}$
Dominant Wavelength ^[1] Green Blue	λ_d	519.0 460.0	525.0 470.0	539.0 480.0	nm	$I_F = 20\text{ mA}$
Peak Wavelength Green Blue	λ_{PEAK}		516 464		nm	Peak of Wavelength of Spectral Distribution at $I_F = 20\text{ mA}$
Spectral Half Width Green Blue	$\Delta\lambda_{1/2}$		30 23		nm	$I_F = 20\text{ mA}$
Thermal Resistance	$R\theta_{J-PIN}$		240		$^\circ\text{C}/\text{W}$	LED Junction-to-Pin
Luminous Efficacy ^[2] Green Blue	η_V		518 78		lm/W	Emitted Luminous Flux / Emitted Radiant Flux
Thermal coefficient of λ_d Green Blue			0.028 0.024		nm/ $^\circ\text{C}$	$I_F = 20\text{ mA}$; $+25^\circ\text{C} \leq T_J \leq +100^\circ\text{C}$

Notes:

1. The dominant wavelength is derived from the chromaticity Diagram and represents the color of the lamp
2. The radiant intensity, I_e in watts per steradian, may be found from the equation $I_e = I_V/\eta_V$ where I_V is the luminous intensity in candelas and η_V is the luminous efficacy in lumens/watt.

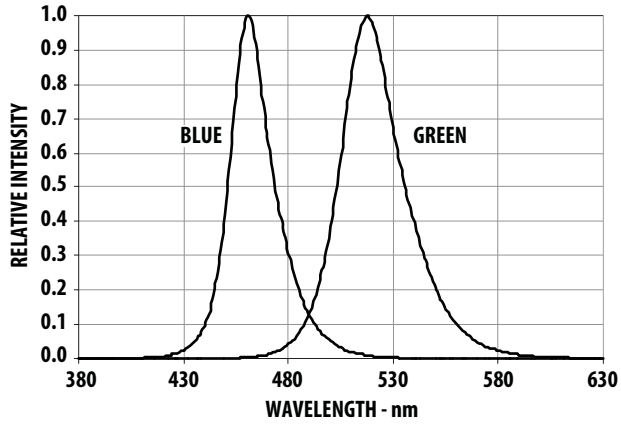

Figure 1. Relative Intensity vs Wavelength

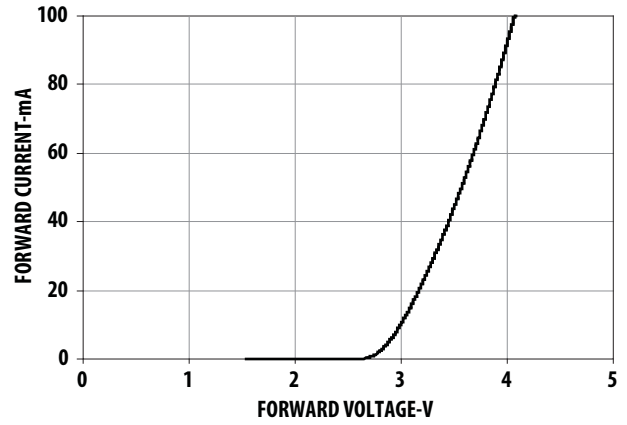

Figure 2. Forward Current vs Forward Voltage

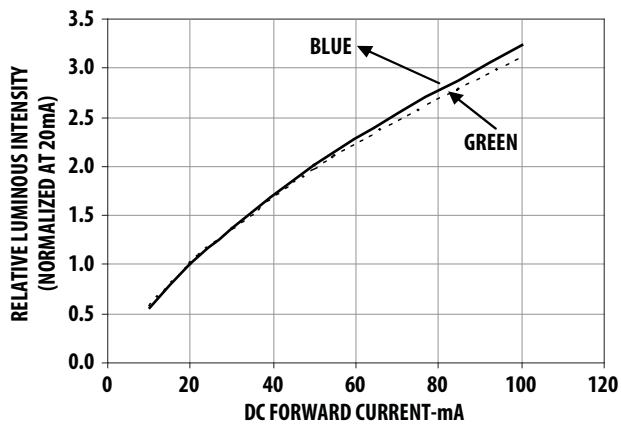

Figure 3. Relative Intensity vs Forward Current

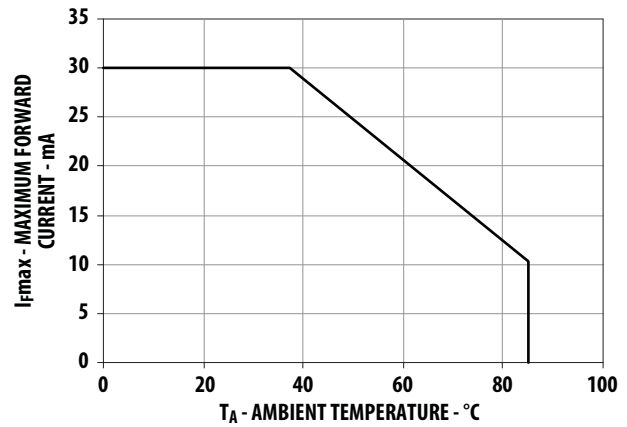

Figure 4. Maximum Forward Current vs Ambient Temperature

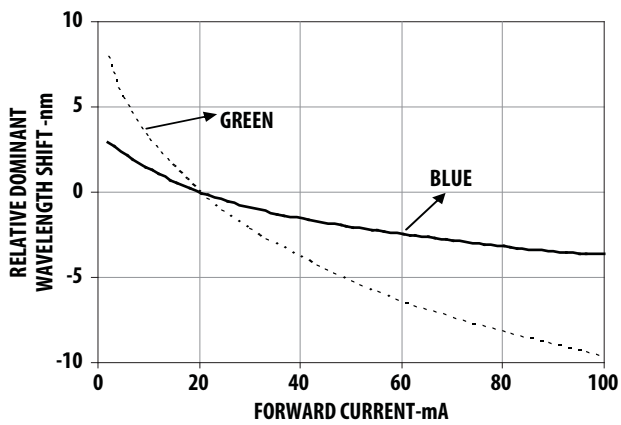

Figure 5. Relative Dominant Wavelength Shift vs Forward Current

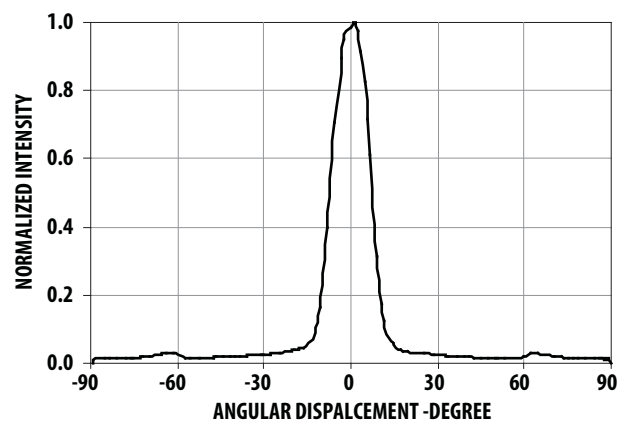

Figure 6. Radiation Pattern for 15°

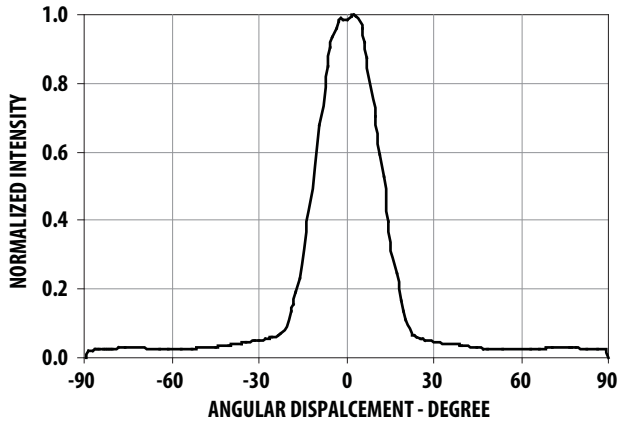

Figure 7. Radiation Pattern for 23°

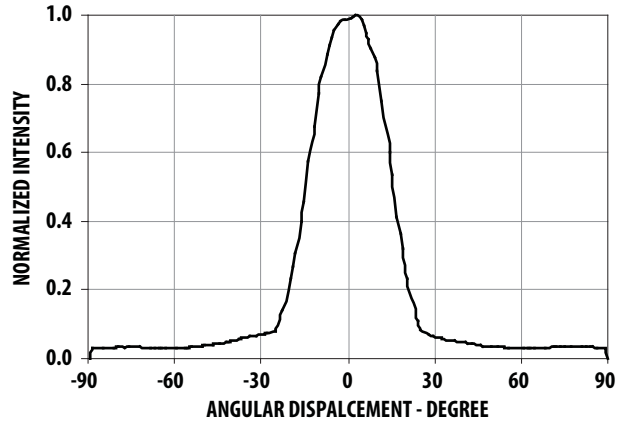

Figure 8. Radiation Pattern for 30°

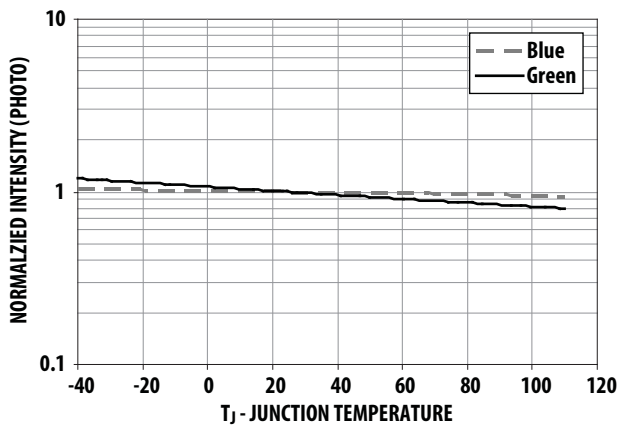

Figure 9. Relative Light Output vs Junction Temperature

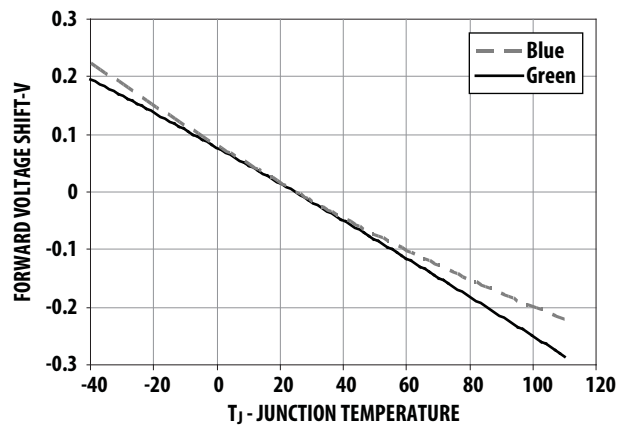

Figure 10. Relative Forward Voltage vs Junction Temperature

Intensity Bin Limit Table (1.3:1 Iv bin ratio)

Bin	Intensity (mcd) at 20mA	
	Min	Max
U	3200	4200
V	4200	5500
W	5500	7200
X	7200	9300
Y	9300	12000
Z	12000	16000
1	16000	21000
2	21000	27000
3	27000	35000
4	35000	45000
5	45000	59000

Tolerance for each bin limit is $\pm 15\%$

Note:

- All bin categories are established for classification of products. Products may not be available in all bin categories. Please contact your Avago representative for further information.

Green Color Bin Table

Bin	Min Dom	Max Dom
1	519.0	523.0
2	523.0	527.0
3	527.0	531.0
4	531.0	535.0
5	535.0	539.0

Tolerance for each bin limit is $\pm 0.5\text{nm}$.

Blue Color Bin Table

Bin	Min Dom	Max Dom
1	460.0	464.0
2	464.0	468.0
3	468.0	472.0
4	472.0	476.0
5	476.0	480.0

Tolerance for each bin limit is $\pm 0.5\text{nm}$.

Precautions:

Lead Forming:

- The leads of an LED lamp may be preformed or cut to length prior to insertion and soldering on PC board.
- For better control, it is recommended to use proper tool to precisely form and cut the leads to applicable length rather than doing it manually.
- If manual lead cutting is necessary, cut the leads after the soldering process. The solder connection forms a mechanical ground which prevents mechanical stress due to lead cutting from traveling into LED package. This is highly recommended for hand solder operation, as the excess lead length also acts as small heat sink.

Soldering and Handling:

- Care must be taken during PCB assembly and soldering process to prevent damage to the LED component.
- LED component may be effectively hand soldered to PCB. However, it is only recommended under unavoidable circumstances such as rework. The closest manual soldering distance of the soldering heat source (soldering iron's tip) to the body is 1.59mm. Soldering the LED using soldering iron tip closer than 1.59mm might damage the LED.

- ESD precaution must be properly applied on the

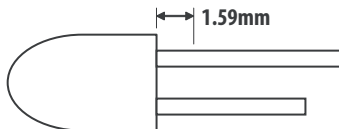

soldering station and personnel to prevent ESD damage to the LED component that is ESD sensitive. Do refer to Avago application note AN 1142 for details. The soldering iron used should have grounded tip to ensure electrostatic charge is properly grounded.

- Recommended soldering condition:

	Wave Soldering [1, 2]	Manual Solder Dipping
Pre-heat temperature	105°C Max.	-
Preheat time	60 sec Max	-
Peak temperature	260°C Max.	260°C Max.
Dwell time	5 sec Max.	5 sec Max

Note:

1. Above conditions refers to measurement with thermocouple mounted at the bottom of PCB.
 2. It is recommended to use only bottom preheaters in order to reduce thermal stress experienced by LED.
- Wave soldering parameters must be set and maintained according to the recommended temperature and dwell time. Customer is advised to perform daily check on the soldering profile to ensure that it is always conforming to recommended soldering conditions.

Note:

1. PCB with different size and design (component density) will have different heat mass (heat capacity). This might cause a change in temperature experienced by the board if same wave soldering setting is used. So, it is recommended to re-calibrate the soldering profile again before loading a new type of PCB.

Avago Technologies LED Configuration

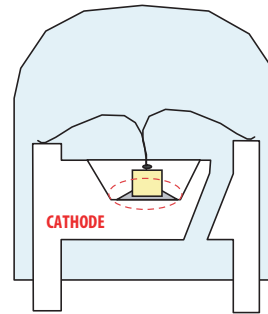

InGaN Device

- Any alignment fixture that is being applied during wave soldering should be loosely fitted and should not apply weight or force on LED. Non metal material is recommended as it will absorb less heat during wave soldering process.
- At elevated temperature, LED is more susceptible to mechanical stress. Therefore, PCB must allowed to cool down to room temperature prior to handling, which includes removal of alignment fixture or pallet.
- If PCB board contains both through hole (TH) LED and other surface mount components, it is recommended that surface mount components be soldered on the top side of the PCB. If surface mount need to be on the bottom side, these components should be soldered using reflow soldering prior to insertion the TH LED.
- Recommended PC board plated through holes (PTH) size for LED component leads.

LED component lead size	Diagonal	Plated through hole diameter
0.45 x 0.45 mm (0.018x 0.018 inch)	0.636 mm (0.025 inch)	0.98 to 1.08 mm (0.039 to 0.043 inch)
0.50 x 0.50 mm (0.020x 0.020 inch)	0.707 mm (0.028 inch)	1.05 to 1.15 mm (0.041 to 0.045 inch)

- Over-sizing the PTH can lead to twisted LED after clinching. On the other hand under sizing the PTH can cause difficulty inserting the TH LED.

Refer to application note AN5334 for more information about soldering and handling of high brightness TH LED lamps.

Example of Wave Soldering Temperature Profile for TH LED

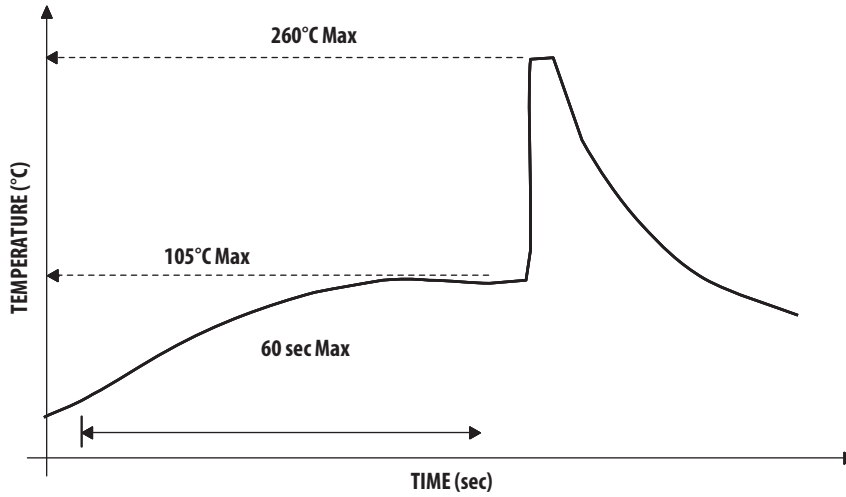

Recommended solder:
 Sn63 (Leaded solder alloy)
 SAC305 (Lead free solder alloy)

Flux: Rosin flux

Solder bath temperature: 255°C ± 5°C
 (maximum peak temperature = 260°C)

Dwell time: 3.0 sec - 5.0 sec
 (maximum = 5sec)

Note: Allow for board to be sufficiently cooled to room temperature before exerting mechanical force.

Ammo Packs Drawing

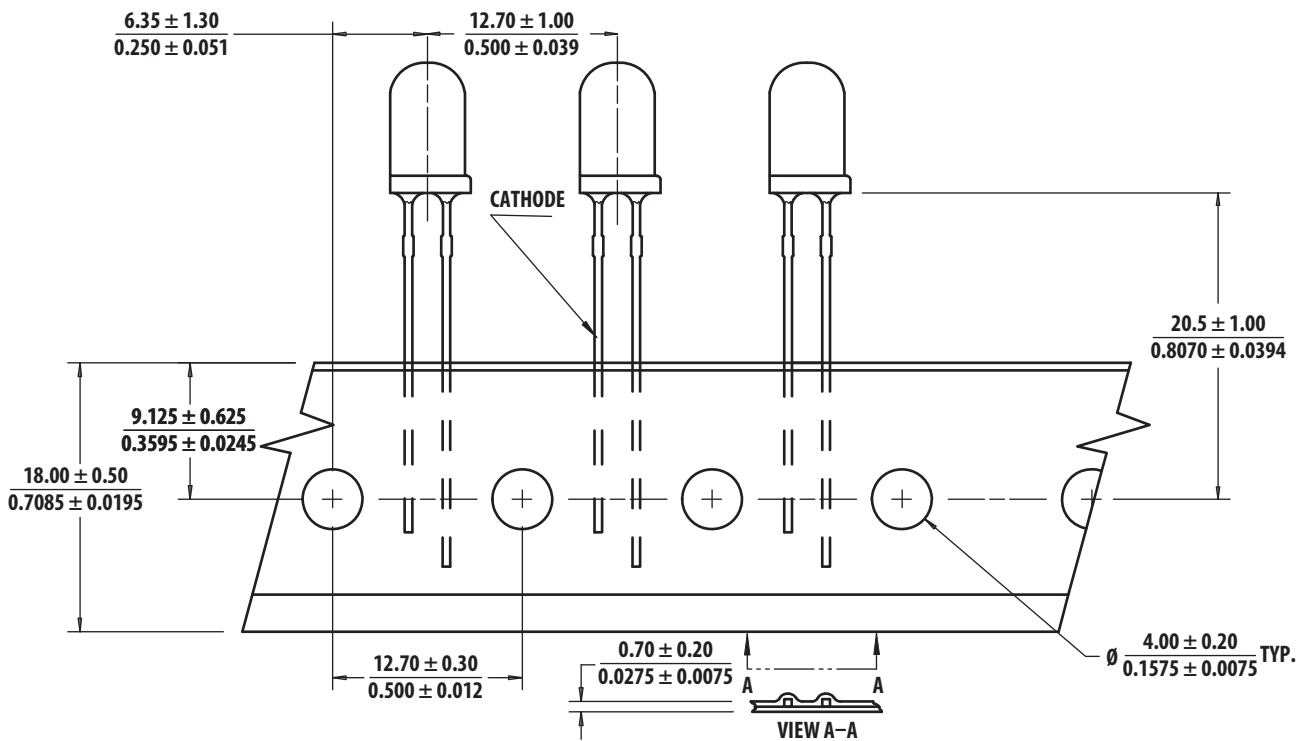

Note: The ammo-packs drawing is applicable for packaging option -DD & -ZZ and regardless standoff or non-standoff



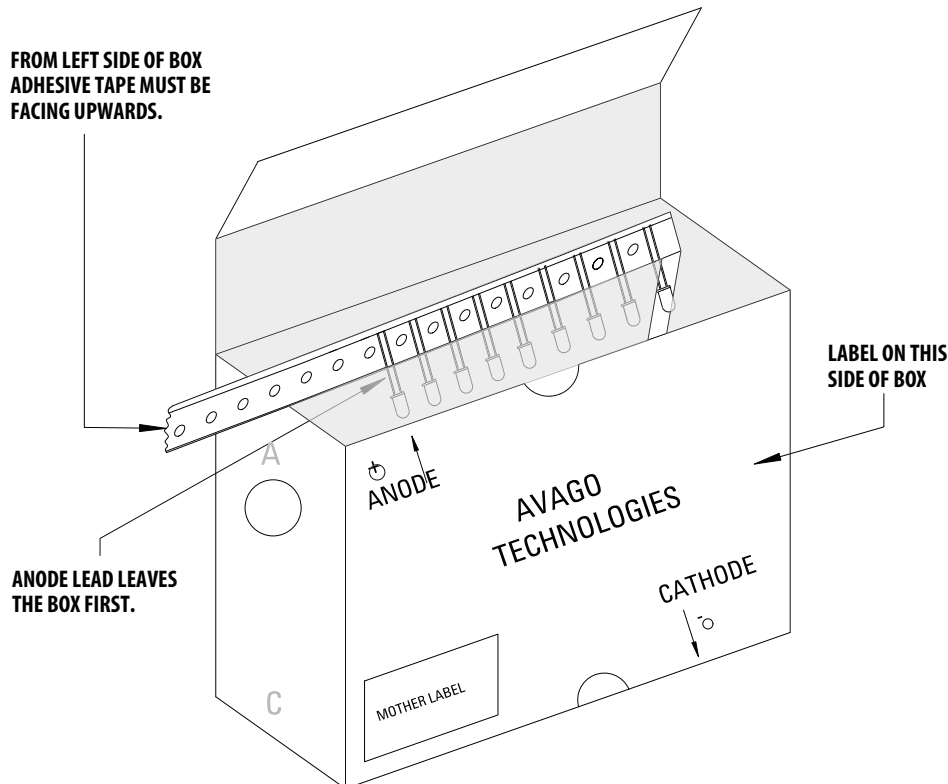









Packaging Box for Ammo Packs













Note: For InGaN device, the ammo pack packaging box contain ESD logo

Packaging Label

(i) Avago Mother Label: (Available on packaging box of ammo pack and shipping box)

 Avago TECHNOLOGIES	
(1P) Item: Part Number	STANDARD LABEL LS0002
	RoHS Compliant
(1T) Lot: Lot Number	e3 max temp 260C
	(Q) QTY: Quantity
LPN:	
	CAT: Intensity Bin
(9D)MFG Date: Manufacturing Date	
	BIN: Color Bin
<hr/>	
(P) Customer Item:	
	
(V) Vendor ID:	(9D) Date Code: Date Code
	
<hr/>	
DeptID:	Made In: Country of Origin
	

(ii) Avago Baby Label (Only available on bulk packaging)

		RoHS Compliant e3 max temp 260C	
Lamps Baby Label			
(1P) PART #: Part Number			
			
(1T) LOT #: Lot Number			
			
(9D)MFG DATE: Manufacturing Date		QUANTITY: Packing Quantity	
			
C/O: Country of Origin			
Customer P/N:		CAT: Intensity Bin	
			
Supplier Code:		BIN: Color Bin	
			
		DATECODE: Date Code	
			

DISCLAIMER: Avago's products and software are not specifically designed, manufactured or authorized for sale as parts, components or assemblies for the planning, construction, maintenance or direct operation of a nuclear facility or for use in medical devices or applications. Customer is solely responsible, and waives all rights to make claims against avago or its suppliers, for all loss, damage, expense or liability in connection with such use.

For product information and a complete list of distributors, please go to our web site: www.avagotech.com

Avago, Avago Technologies, and the A logo are trademarks of Avago Technologies in the United States and other countries. Data subject to change. Copyright © 2005-2009 Avago Technologies. All rights reserved.
AV02-2228EN - December 15, 2009

