

Technical Information for LP Gas Sensors

The Figaro 2600 series is a new type thick film metal oxide semiconductor, screen printed gas sensor which offers miniaturization and lower power consumption. The TGS2610 displays high selectivity and sensitivity to LP gas and its components (e.g. propane and butane).



	<u>Page</u>
Basic Information and Specifications	
Features.....	2
Applications.....	2
Structure.....	2
Basic Measuring Circuit.....	2
Circuit & Operating Conditions.....	3
Specifications.....	3
Dimensions.....	3
Typical Sensitivity Characteristics	
Sensitivity to Various Gases.....	4
Temperature and Humidity Dependency.....	5
Heater & Circuit Voltage Dependency.....	6
Gas Response.....	7
Initial Action.....	7
Long Term Characteristics.....	8
Reliability	
Gas Exposure Test.....	9~10
Corrosion Test.....	10
Ignition Test.....	10
Effect of Air Flow.....	11
Heater Resistance Durability.....	11
Cautions.....	12
See also Technical Brochure 'Technical Information on Usage of TGS Sensors for Toxic and Explosive Gas Leak Detectors'.	

IMPORTANT NOTE: OPERATING CONDITIONS IN WHICH FIGARO SENSORS ARE USED WILL VARY WITH EACH CUSTOMER'S SPECIFIC APPLICATIONS. FIGARO STRONGLY RECOMMENDS CONSULTING OUR TECHNICAL STAFF BEFORE DEPLOYING FIGARO SENSORS IN YOUR APPLICATION AND, IN PARTICULAR, WHEN CUSTOMER'S TARGET GASES ARE NOT LISTED HEREIN. FIGARO CANNOT ASSUME ANY RESPONSIBILITY FOR ANY USE OF ITS SENSORS IN A PRODUCT OR APPLICATION FOR WHICH A SENSOR HAS NOT BEEN SPECIFICALLY TESTED BY FIGARO.



TGS2610-C and -D are UL recognized components in accordance with the requirements of UL2075. Please note that component recognition testing has confirmed long term stability in 60ppm of propane; other characteristics shown in this brochure have not been confirmed by UL as part of component recognition.

TGS2610 is available in two different models which have different external housings but identical sensitivity to LP gas. **TGS2610-C** possesses small size and quick gas response, making it suitable for gas leakage checkers, while **TGS2610-D** uses filter material in its housing to eliminate the influence of interference gases such as alcohol, resulting in highly selective response to LP gas.

1. Basic Information and Specifications

1-1 Features

- * High selectivity to LP gas
- * Low power consumption
- * Small size
- * Long life and low cost
- * Uses simple electrical circuit

1-2 Applications

- * Residential LP gas leak detectors
- * Recreational vehicle LP gas leak detectors

1-3 Structure

Figure 1 shows the structure of TGS2610. Using thick film techniques, the sensing material (SnO₂) is printed on electrodes (noble metal) which have been printed onto an alumina substrate. One electrode is connected to pin No.2 and the other is connected to pin No.3. The sensor element is heated by RuO₂ material printed onto the reverse side of the substrate and connected to pins No.1 and No.4.

Lead wires are Pt-W alloy and are connected to sensor pins which are made of Ni-plated Ni-Fe 50%.

The sensor base is made of Ni-plated steel. The caps of both TGS2610-C and TGS2610-D are stainless steel. The upper opening in both caps is covered with a double layer of 100 mesh stainless steel gauze (SUS316). The TGS2610-D utilizes a zeolite filter inside the cap for reducing the influence of interference gases.

1-4 Basic measuring circuit

Figure 2 shows the basic measuring circuit. Circuit voltage (V_C) is applied across the sensor element which has a resistance (R_S) between the sensor's two electrodes and the load resistor (R_L) connected in series. When DC is used for V_C, the polarity shown in Figure 2 **must** be maintained. The V_C may be applied intermittently. The sensor signal (V_{RL}) is measured indirectly as a change in voltage across the R_L. The R_S is obtained from the formula shown at the right.

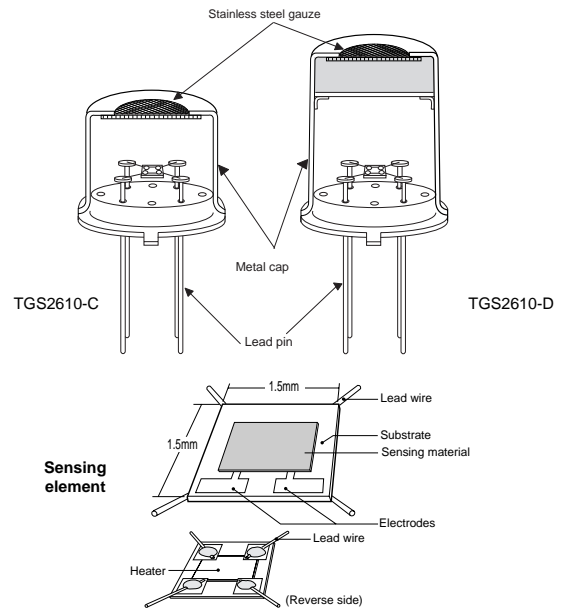

Fig. 1 - Sensor structure

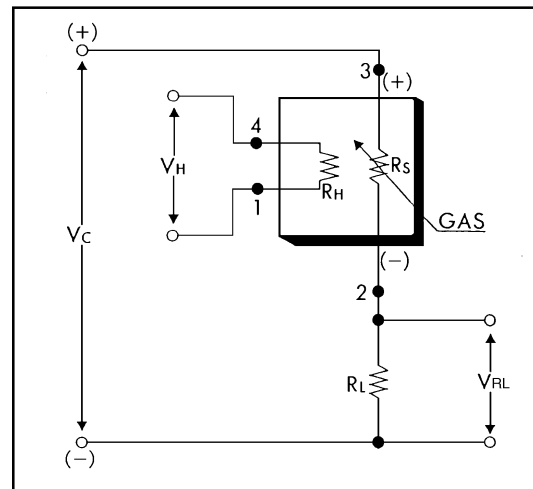

Fig. 2 - Basic measuring circuit

NOTE: In the case of V_H, there is no polarity, so pins 1 and 4 can be considered interchangeable. However, in the case of V_C, when used with DC power, pins 2 and 3 must be used as shown in the Figure above.

$$R_S = \frac{V_C - V_{RL}}{V_{RL}} \times R_L$$

Formula to determine R_S

1-5 Circuit & operating conditions

The ratings shown below should be maintained at all times to insure stable sensor performance:

Item	Specification
Circuit voltage (Vc)	5.0V ± 0.2V DC/AC
Heater voltage (VH)	5.0V ± 0.2V DC/AC
Inrush heater current (VH=5.0V)	100mA max.
Heater resistance (room temp.)	approx. 59Ω
Load resistance (RL)	variable (0.45kΩ min.)
Sensor power dissipation (Ps)	≤ 15mW
Operating & storage temperature	-40°C ~ +70°C
Optimal detection concentration	500 ~ 10,000ppm

1-6 Specifications NOTE 1

Item	Specification
Sensor resistance (1800ppm iso-butane)	0.68kΩ ~ 6.8kΩ
Sensor resistance gradient (β)	0.56 ± 0.06
$\beta = R_s(3000\text{ppm iso-butane})/R_s(1000\text{ppm iso-butane})$	
Heater current	56 ± 5mA
Heater power consumption	approx. 280mW

NOTE 1: Sensitivity characteristics are obtained under the following standard test conditions:

(Standard test conditions)

Temperature and humidity: 20 ± 2°C, 65 ± 5% RH

Circuit conditions: Vc = 5.0±0.01V DC

VH = 5.0±0.05V DC

RL = 10.0kΩ ± 1%

Preheating period: 7 days or more under standard circuit conditions

All sensor characteristics shown in this brochure represent typical characteristics. Actual characteristics vary from sensor to sensor and from production lot to production lot. The only characteristics warranted are those shown in the Specification table above.

1-7 Dimensions

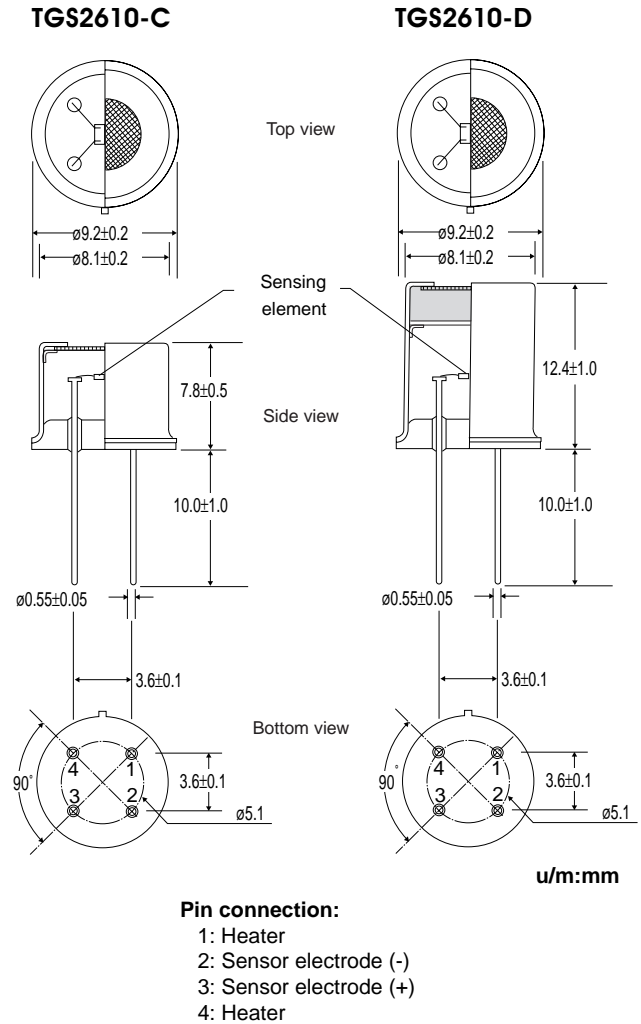

Fig. 3 - Sensor dimensions

Mechanical Strength:

The sensor shall have no abnormal findings in its structure and shall satisfy the above electrical specifications after the following performance tests:

Withdrawal Force - withstand force of 5kg in each (pin from base) direction

Vibration - frequency-1000c/min., total amplitude-4mm, duration-one hour, direction-vertical

Shock - acceleration-100G, repeated 5 times

2. Typical Sensitivity Characteristics

2-1 Sensitivity to various gases

Figures 4a and 4b show the relative sensitivity of TGS2610 to various gases. The Y-axis shows the ratio of the sensor resistance in various gases (R_s) to the sensor resistance in 1800ppm of iso-butane (R_o).

For TGS2610-C, the sensitivity to ethanol, which may act as an interference gas, is lower compared with that of iso-butane/propane. However, TGS2610-D shows significantly less sensitivity to alcohol than TGS2610-C while showing no significant difference in sensitivity to iso-butane/propane.

Using the basic measuring circuit illustrated in Fig. 2, and with a matched RL value equivalent to the R_s value in 1800ppm of iso-butane, will provide the sensor output voltage (VRL) change as shown in Figure 5.

NOTE:

All sensor characteristics in this technical brochure represent typical sensor characteristics. Since the R_s or output voltage curve varies from sensor to sensor, calibration is required for each sensor (for additional information on calibration, please refer to the Technical Advisory 'Technical Information on Usage of TGS Sensors for Toxic and Explosive Gas Leak Detectors').

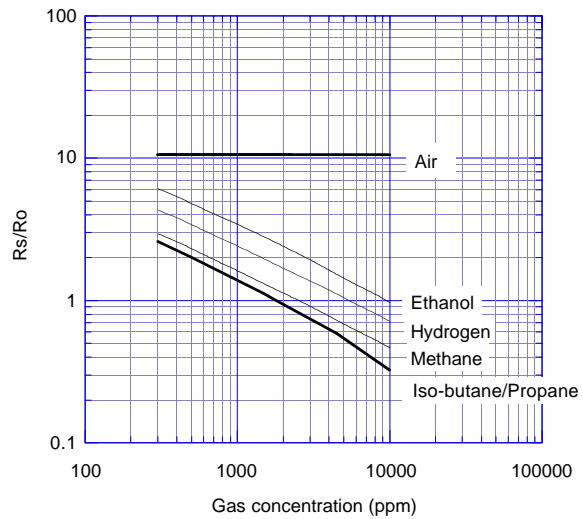

Fig. 4a - TGS2610-C00 sensitivity to various gases (R_s/R_o)

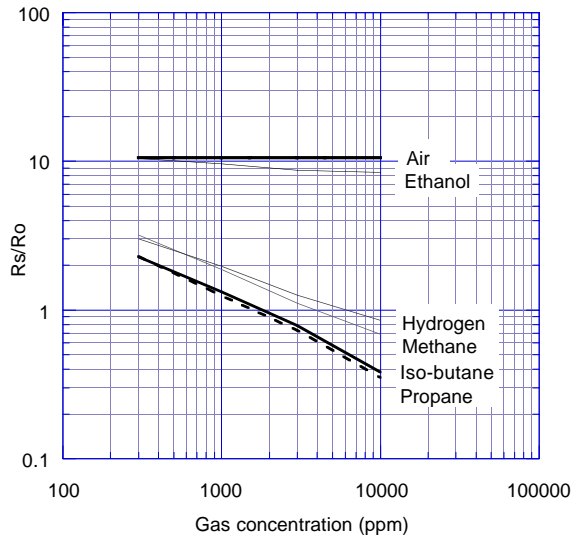

Fig. 4b - TGS2610-D00 sensitivity to various gases (R_s/R_o)

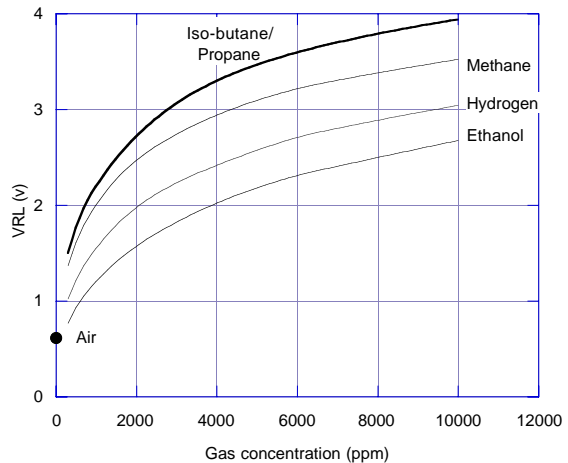

Fig. 5 - Sensitivity to various gases (VRL)

2-2 Temperature and humidity dependency

Figure 6 shows the temperature and humidity dependency of TGS2610. The Y-axis shows the ratio of sensor resistance in 1800ppm of iso-butane under various atmospheric conditions (R_s) to the sensor resistance in 1800ppm of iso-butane at 20°C / 65%RH (R_o).

R.H. (°C)	35%R.H.	50%R.H.	65%R.H.	95%R.H.
-10				1.60
0			1.50	1.35
10		1.50	1.23	1.08
20	1.52	1.19	1.00	0.85
30	1.23	0.94	0.79	0.68
40	0.98	0.75	0.61	0.53

Table 1 - Temperature and humidity dependency
(typical values of R_s/R_o for Fig. 6)

Table 1 shows a table of values of sensor resistance ratio (R_s/R_o) under the same conditions as those used to generate Figure 6.

Figure 7 shows the sensitivity curve for TGS2610 to iso-butane under several ambient conditions. While temperature may have a large influence on absolute R_s values, this chart illustrates the fact that effect on the slope of sensor resistance ratio (R_s/R_o) is not significant. As a result, the effects of temperature on the sensor can easily be compensated.

For economical circuit design, a thermistor can be incorporated to compensate for temperature (for additional information on temperature compensation in circuit designs, please refer to the Technical Advisory 'Technical Information on Usage of TGS Sensors for Toxic and Explosive Gas Leak Detectors').

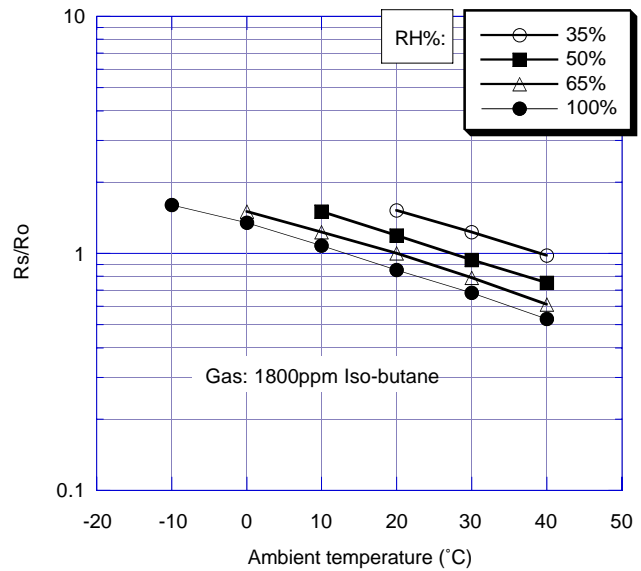

Fig. 6 - Temperature and humidity dependency (R_s/R_o)

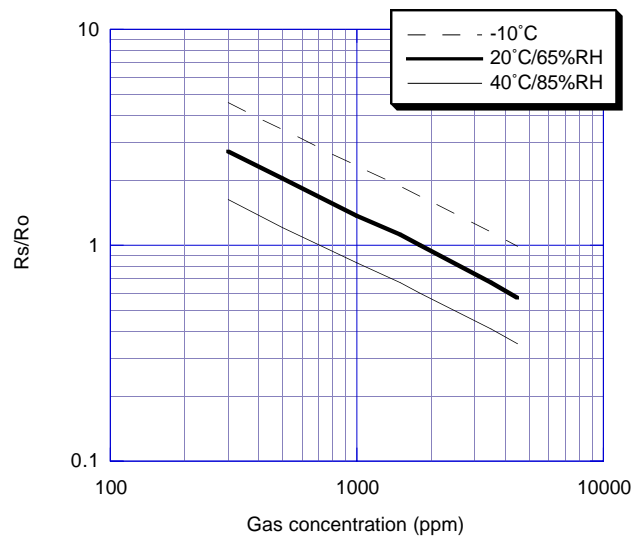

Fig. 7 - Sensor resistance under various ambient conditions

2-3 Heater voltage dependency

Figure 8 shows the change in the sensor resistance ratio according to variations in the heater voltage (VH).

Note that 5.0V as a heater voltage must be maintained because variance in applied heater voltage will cause the sensor's characteristics to be changed from the typical characteristics shown in this brochure.

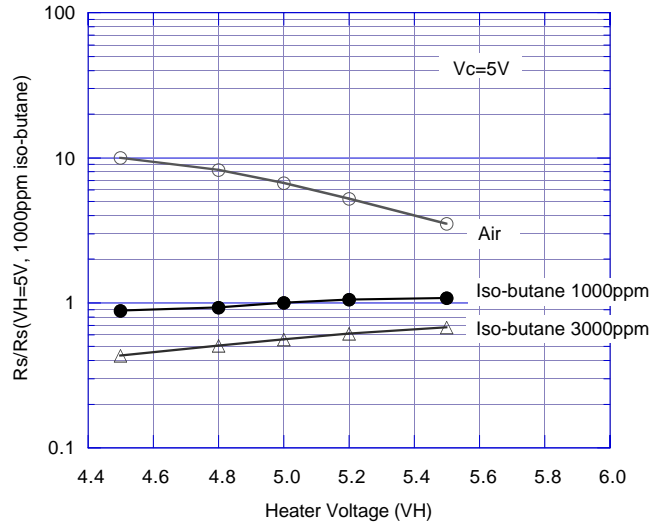

Fig. 8 - Heater voltage dependency (Vc=5.0)

2-4 Circuit voltage dependency

Figure 9 shows the change in the sensor resistance ratio resulting from variation in circuit voltage (Vc).

As shown here, using a Vc higher than the 5.0V specified in Section 1-5 may result in the sensor diverging from Ohmic behavior and thus altering its characteristics from those shown as typical in this brochure.

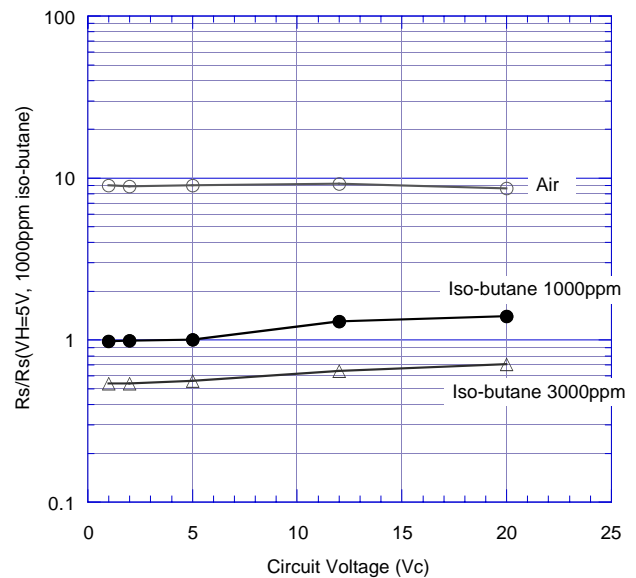

Fig. 9 - Circuit voltage dependency (VH=5.0)

2-5 Gas response

Figures 10a and 10b show the change pattern of sensor resistance (R_s) for TGS2610-C and TGS2610-D respectively when the sensor is inserted into and later removed from 1800ppm of iso-butane.

As these charts display, the sensor's response speed to the presence of gas is extremely quick, and when removed from gas, the sensor will recover back to its original value in a short period of time. Compared to TGS2610-C, TGS2610-D shows slower response due to the airflow resistance of the sensor's filter layer.

Figure 11 demonstrates the sensor's repeatability by showing multiple exposures to a 1800ppm concentration of iso-butane. Unlike the test done for Fig. 10, here the sensor is located in a single environment which is exchanged periodically. As a result, though the process of gas diffusion reduces sensor response speed, good repeatability can be seen.

2-6 Initial action

Figure 12 shows the initial action of the sensor resistance (R_s) for a sensor which is stored unenergized in normal air for 30 days and later energized in clean air.

The R_s drops sharply for the first seconds after energizing, regardless of the presence of gases, and then reaches a stable level according to the ambient atmosphere. Such behavior during the warm-up process is called "Initial Action".

Since this 'initial action' may cause a detector to alarm unnecessarily during the initial moments after powering on, it is recommended that an initial delay circuit be incorporated into the detector's design (refer to Technical Advisory 'Technical Information on Usage of TGS Sensors for Toxic and Explosive Gas Leak Detectors'). This is especially recommended for intermittent-operating devices such as portable gas detectors.

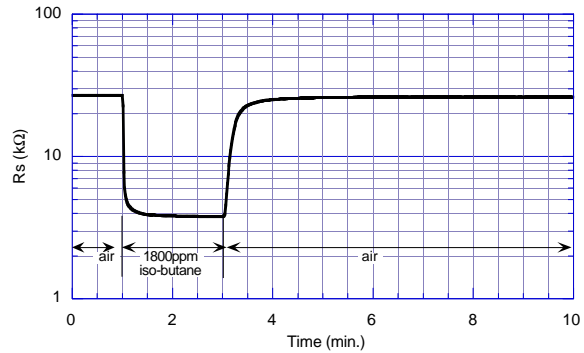

Fig. 10 - Gas response to iso-butane of TGS2610-C

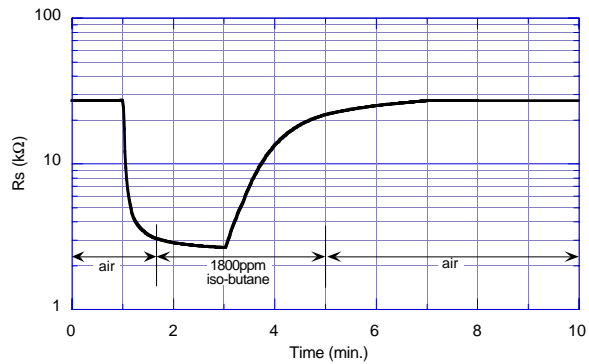

Fig. 10b - Gas response to iso-butane of TGS2610-D

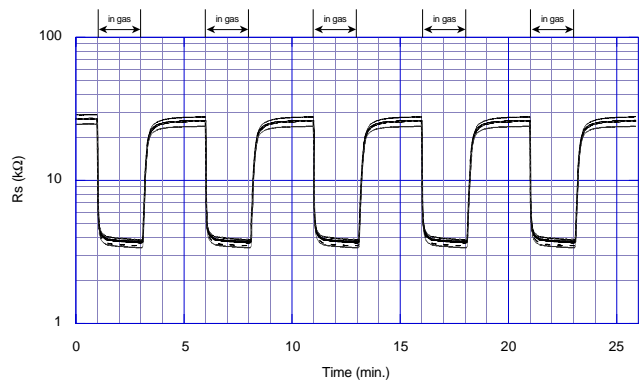

Fig. 11 - Repeatability

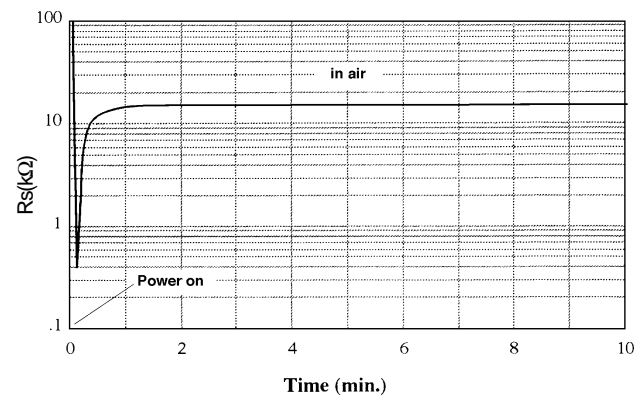

Fig. 12 - Initial action

2-7 Long-term characteristics

Figure 13 shows long-term stability of TGS2610 as measured for more than 900 days. The sensor is first energized in normal air. Measurement for confirming sensor characteristics is conducted under standard test conditions. The initial value of R_s was measured after two days energizing in normal air at the rated voltage. The Y-axis represents the sensor resistance in air, 3500ppm of methane, 1500ppm of iso-butane, and 3500ppm of hydrogen.

The R_s in iso-butane is very stable over the test period.

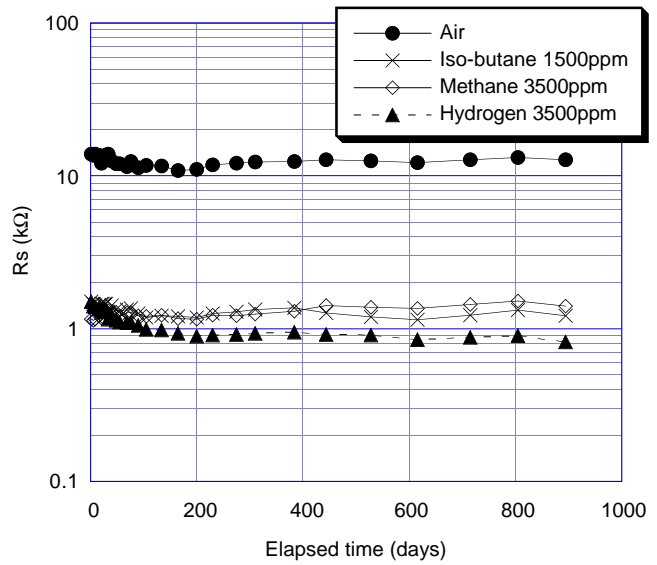

Fig. 13 - Long-term stability (continuous energizing) of TGS2610-C

Figure 14 shows the influence of storage in an unenergized condition on the sensor's resistance. The sensors were stored unenergized in air after 20 days energizing, then energized for one hour before a measurement was taken.

As the charts presented in this section illustrate, the sensor shows stable long term characteristics.

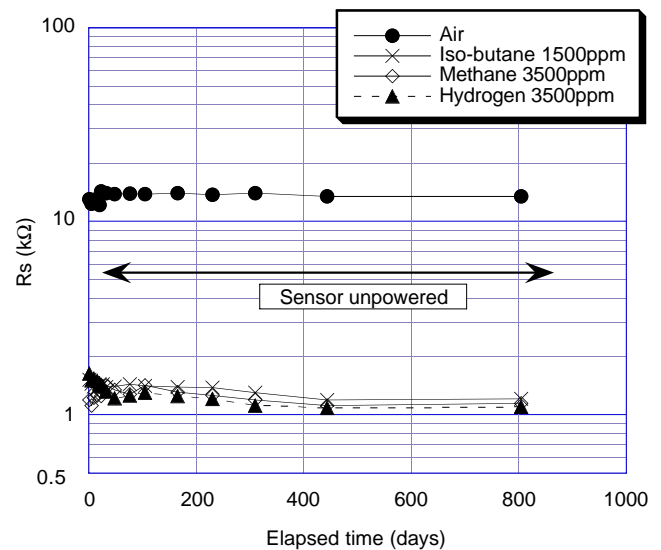

Fig. 14 - Influence of unenergizing on TGS2610-C

3. Reliability

3-1 Gas exposure test #1

Figure 15 shows the test procedure of short-term high concentration exposure to iso-butane gas. During this test, the sensor was kept energized under standard circuit conditions. The sensor resistance in both 1500ppm and 4500ppm of iso-butane was measured during 4 minute periods before and after the gas exposures (runs #1~12). All exposures in gas during this test were followed by exposure in normal air.

The gas exposure conditions were 4500ppm for 10 minutes, 9000ppm for 10 minutes, 1.5% (15000ppm) for 10 minutes, and 1.5% for 30 minutes. A second 30 minute exposure in 1.5% was done, but with VH set equal to 6.0V.

Two days elapsed before test run #11 was completed. After this, sensors were energized in normal air for 3 days before run #12 for checking long-term effects.

Heater resistance at room temperature was also measured after gas exposure in order to check for the influence of high concentration gas exposure.

The test results are shown in Figs. 16 and 17. The 1.5% iso-butane exposure while $V_H=5.0V$ appeared to increase sensor resistance in gas temporarily (run #8~9). Increasing heater voltage to 6.0V during 1.5% exposure caused a decrease in heater current, resulting in decreased sensor resistance in gas. In this case, the heater current did not recover to its original value (run #10~12).

As this section illustrates, exposure to iso-butane itself will cause a transitory effect from which the sensor can recover. However, high intensity exposure, coupled with higher than standard heater voltage, will cause a permanent change in heater current due to combustion of gas on the surface of the heater material at elevated heater voltage. Note that this phenomenon would not occur when elevated heater voltage is applied in fresh air (see Figure 22). In addition, sensor characteristics may also be altered due to combustion on the surface of the sensing material.

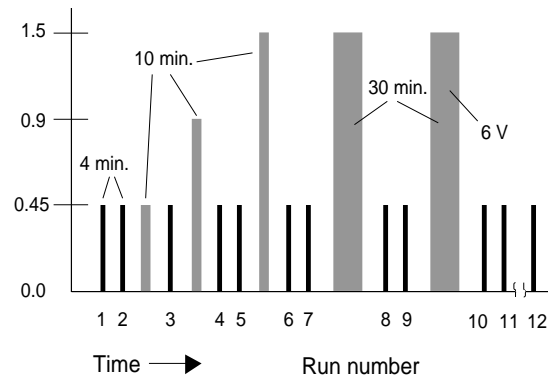

Fig. 15 - Test procedure for gas exposure

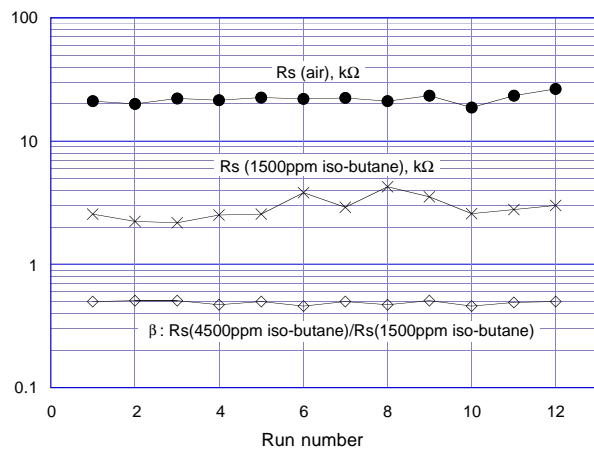

Fig. 16 - Effect of iso-butane exposure on R_s of TGS2610-C

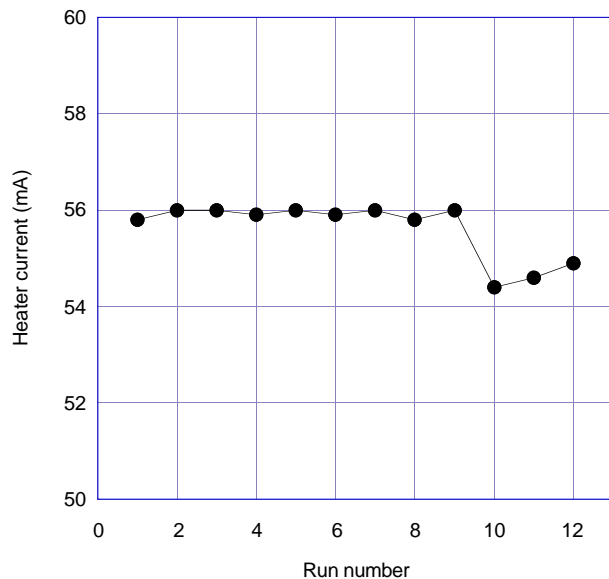

Fig. 17 - Effect of gas exposure on heater current of TGS2610-C

3-2 Gas exposure test #2

Figure 18 shows the effect on TGS2610 of a high concentration of ethanol vapor on sensor characteristics.

Sensors were energized and their resistance prior to ethanol exposure was measured. The sensors were then placed in a 10% concentration of ethanol for 20 hours. After this exposure, the sensor was energized in normal air for 1 hour prior to measuring sensor resistance. After an additional 1 day of energizing, the sensor resistance was measured again.

As this data would suggest, sensor characteristics remain largely unaffected after exposure to a high concentration of ethanol.

3-3 Corrosion test (*)

Figure 19 shows the effect on TGS2610 of corrosive gases specified in Item 43.15 of the UL 1484 standard.

Sensor resistance prior to corrosive gas exposure was measured. Unenergized sensors were then placed into an environment of 23±2°C and 95%RH. In this environment, two separate tests were conducted: one in 0.1% H₂S, the other in a combination of 0.5% SO₂ and 1.0% CO₂, with each test exposure lasting 10 days. After this exposure, the sensor was re-energized in normal air prior to measuring sensor resistance after removal from corrosive gases.

As this data would suggest, sensor characteristics remain largely unaffected after exposure to corrosive gas concentrations specified by Sec. 43.15 of UL 1484.

3-4 Ignition test (*)

TGS2610 has been successfully tested against the ignition test requirements of the UL1484 standard. The sensor did not initiate ignition of a propane concentration of 5.25% by volume.

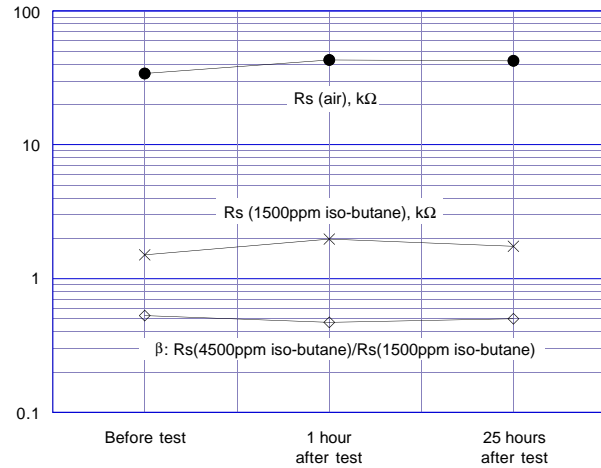

Fig. 18 - Effect of 10% ethanol exposure on TGS2610-C

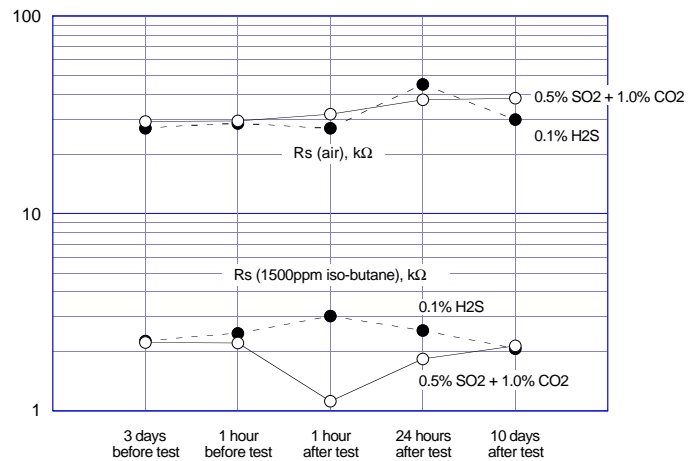

Fig. 19 - Corrosion test of TGS2610-C

(*) The UL 1484 referenced tests have not been reviewed or accepted by Underwriters Laboratory as part of the component recognition.

3-5 Effect of air flow

Figure 20 shows how the sensor signal (V_{RL}) is affected by air flow. The test procedure involves situating the sensor in an air stream of 3.1 meters per second, with the air flow vertical/horizontal to the flameproof stainless steel double gauze of the sensor's housing.

The decrease in sensor signal shown in Figure 20 resulted from the decrease in sensor element temperature caused by the air flow. As a result, direct air flow on the sensor should be avoided.

3-6 Heater resistance durability

Figure 21 illustrates the procedure for testing the effects of excess voltage applied to the heater. Heater resistance was measured while the heater was unpowered and at room temperature.

The results of this test are shown in Figure 22 which shows the change in resistance of the heater when various heater voltages (rather than the standard 5.0V) are applied in the absence of gases.

As this section demonstrates, the heater shows good durability against increased heater voltage. However, since excessive heater voltage will cause the sensor's heater resistance to drift upwards, excessive heater voltage should still be avoided.

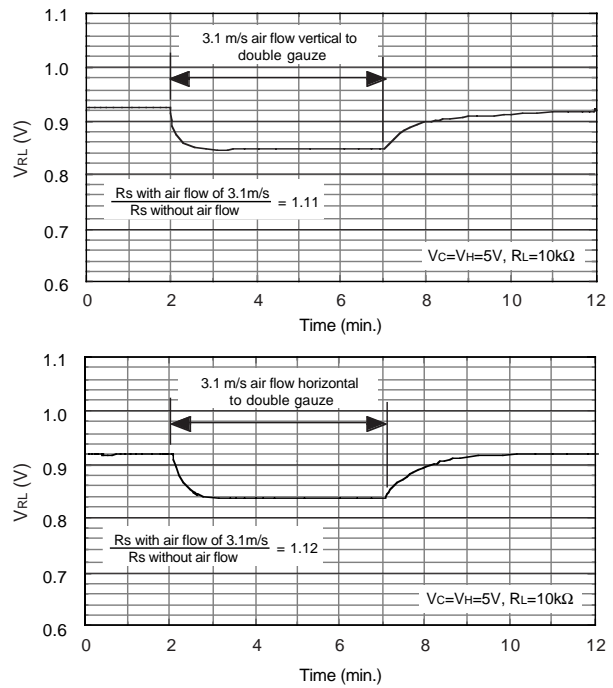

Fig. 20 - Effect of air flow on TGS2610-C

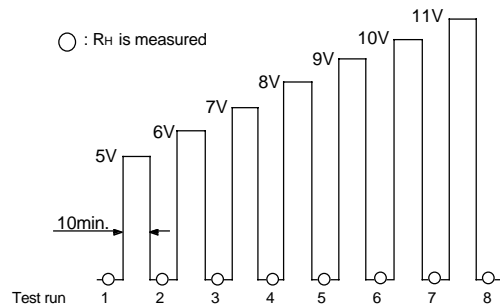

Fig. 21 - Test procedure for heater durability

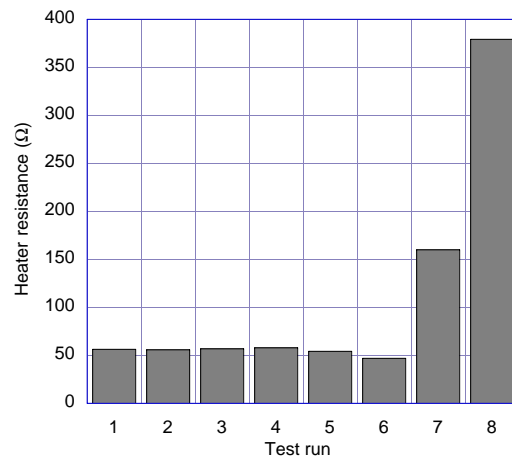

Fig. 22 - Short-term effect of V_H on R_H

4 Cautions on Usage of Figaro Gas Sensors

4-1 Situations which must be avoided

1) Exposure to silicone vapors

If silicone vapors adsorb onto the sensor's surface, the sensing material will be coated, irreversibly inhibiting sensitivity. Avoid exposure where silicone adhesives, hair grooming materials, or silicone rubber/putty may be present.

2) Highly corrosive environment

High density exposure to corrosive materials such as H₂S, SO_x, Cl₂, HCl, etc. for extended periods may cause corrosion or breakage of the lead wires or heater material.

3) Contamination by alkaline metals

Sensor drift may occur when the sensor is contaminated by alkaline metals, especially salt water spray.

4) Contact with water

Sensor drift may occur due to soaking or splashing the sensor with water.

5) Freezing

If water freezes on the sensing surface, the sensing material would crack, altering characteristics.

6) Application of excessive voltage

If higher than specified voltage is applied to the sensor or the heater, lead wires and/or the heater may be damaged or sensor characteristics may drift, even if no physical damage or breakage occurs.

7) Operation in zero/low oxygen environment

TGS sensors require the presence of around 21% (ambient) oxygen in their operating environment in order to function properly and to exhibit characteristics described in Figaro's product literature. TGS sensors cannot properly operate in a zero or low oxygen content atmosphere.

4-2 Situations to be avoided whenever possible

1) Water condensation

Light condensation under conditions of indoor usage should not pose a problem for sensor performance.

However, if water condenses on the sensor's surface and remains for an extended period, sensor characteristics may drift.

2) Usage in high density of gas

Sensor performance may be affected if exposed to a high density of gas for a long period of time, regardless of the powering condition.

3) Storage for extended periods

When stored without powering for a long period, the sensor may show a reversible drift in resistance according to the environment in which it was stored. The sensor should be stored in a sealed bag containing clean air; do not use silica gel. *Note that as unpowered storage becomes longer, a longer preheating period is required to stabilize the sensor before usage.*

4) Long term exposure in adverse environment

Regardless of powering condition, if the sensor is exposed in extreme conditions such as very high humidity, extreme temperatures, or high contamination levels for a long period of time, sensor performance will be adversely affected.

5) Vibration

Excessive vibration may cause the sensor or lead wires to resonate and break. Usage of compressed air drivers/ultrasonic welders on assembly lines may generate such vibration, so please check this matter.

6) Shock

Breakage of lead wires may occur if the sensor is subjected to a strong shock.

7) Soldering

Ideally, sensors should be soldered manually. However, wave soldering can be done under the following conditions:

a) Suggested flux: rosin flux with minimal chlorine

b) Speed: 1-2 meters/min.

c) Preheating temperature: 100±20°C

d) Solder temperature: 250±10°C

e) Up to two passes through wave soldering machine allowed

Results of wave soldering cannot be guaranteed if conducted outside the above guidelines since some flux vapors may cause drift in sensor performance similar to the effects of silicone vapors.

NOTE: To achieve the optimal level of accuracy in gas detectors, each TGS2610 sensor should be individually calibrated by matching it with a load resistor (RL) in an environment containing the target gas concentration for alarming (refer to Fig. 2).

For the convenience of users, TGS2610 is classified into 24 groups according to the each sensor's Rs in isobutane. ID numbers marked on the sensor's body indicate the sensor's grouping. Individual sensor calibration can be eliminated by matching the sensor with the recommended RL for each sensor ID. However, because group calibration is used instead of individual calibration, an average of 10% less accuracy would result for detectors using group calibration. Please refer to "Application Notes for TGS2610" for more information.

Figaro USA Inc. and the manufacturer, Figaro Engineering Inc. (together referred to as Figaro) reserve the right to make changes without notice to any products herein to improve reliability, functioning or design. Information contained in this document is believed to be reliable. However, Figaro does not assume any liability arising out of the application or use of any product or circuit described herein; neither does it convey any license under its patent rights, nor the rights of others.

Figaro's products are not authorized for use as critical components in life support applications wherein a failure or malfunction of the products may result in injury or threat to life.

FIGARO GROUP

HEAD OFFICE

Figaro Engineering Inc.
1-5-11 Senba-nishi
Mino, Osaka 562-8505 JAPAN
Tel.: (81) 72-728-2561
Fax: (81) 72-728-0467
email: figaro@figaro.co.jp

OVERSEAS

Figaro USA Inc.
3703 West Lake Ave. Suite 203
Glenview, IL 60026 USA
Tel.: (1) 847-832-1701
Fax.: (1) 847-832-1705
email: figarousa@figarosensor.com