

M A N U A L

SOLAR ASSISTANT “New Generation”

The modern experimenting set for
energy generation with solar cells

Explore - Comprehend – Understand

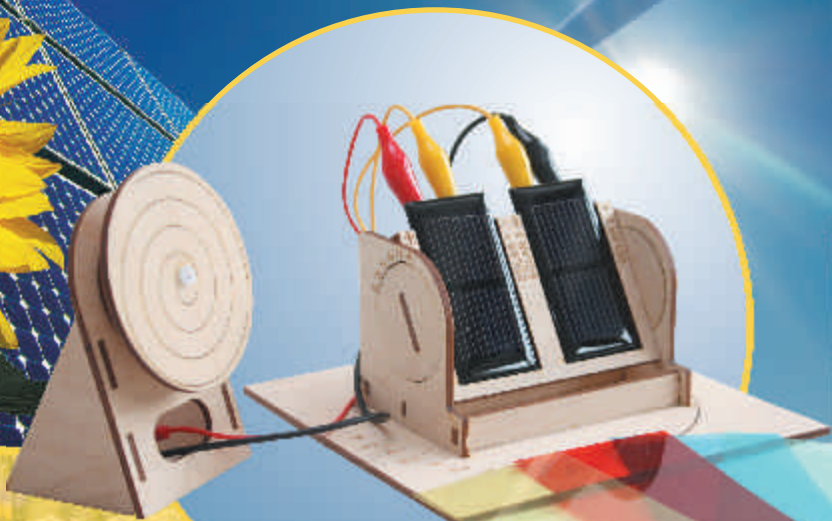

MANUAL



Explore - Comprehend - Understand

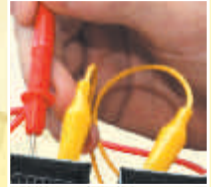
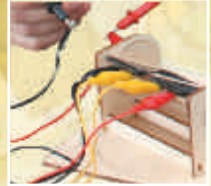

The solar assistant "New Generation" shows the possibilities of photovoltaics in a simple way. In the theoretical part, the topics of sun, photovoltaics in general, energy generation with sun, test criteria, production of solar cells, etc. are explained. The different options, such as island systems and Grid feed-in, are also explained.

The experimental part includes the following areas:

- Different light sources
- Series connection / Parallel connection of solar cells
- Partial shading of solar cells in a compound structure
- Light filters and cloudiness conditions
- Advantages of tracking systems
- Roof incline and influence on the performance



ATTENTION - Safety notices:



Not adequate for children under 3 years
- swallowable small parts!
- Keep company address -



We recommend: Supervision of the experiments by an adult!

<i>The experiment set</i>	
Solar-assistant "New Generation" - The experiments	
Helpful aids - Parts list	4
<i>Construction of the set</i>	
Assembly motor mounting - assembly solar cell mounting	5
<i>The sun as a source of energy</i>	6
<i>Photovoltaics</i>	
The principle - The level of effectiveness - The different solar cells	7
<i>The production of solar cells</i>	8
<i>The conversion of light into energy</i>	
The function - Application examples of photovoltaics	9
<i>Parallel systems</i>	
Feed-in into the public power grid	10
<i>Island systems</i>	
Power supply independent from the public power grid - The solar module - The charge regulator	
The battery - The inverter	11
<i>Examples of use</i>	12
<i>Information about the experiments</i>	
Adequate light sources - Information about the multimeter	13
<i>Different sources of light</i>	14
<i>Light filters</i>	15
<i>Increase of voltage through series connection</i>	16
<i>Increase of power through parallel connection</i>	17
<i>The partial shading of solar cells</i>	18
<i>Shading of solar cells in series connection</i>	19
<i>Shading of solar cells in parallel connection</i>	20
<i>Tips & tricks</i>	21
<i>Horizontal axis movement</i>	22
<i>Vertical axis movement</i>	23



SUN ENERGY

Energy that humans must utilize!



Solar-assistant "New Generation"

The experiment set provides the opportunity to explore the technology and the characteristics of solar cells for power generation in experiments.

The target is to emphasize the topic of power generation through solar technology.

The solar cells that serve as basis for all experiments consist of monocrystalline silicium and are therefore of very high quality.

This enables you to conduct the experiments inside without direct sunlight.

Of course also here the solar cells require sufficient lighting. Ideal is a desk lamp that can be found in every household.

A lamp also has the characteristic that it constantly gives off the same amount of light. Direct sunlight on the contrary may vary depending on the condition of cloudiness, which would lead to a falsification of the measurement data.



The experiments

After a general introduction to this topic you will learn the basic coherencies in solar technology through simple experiments.

Helpful auxiliary means

With the included motor you are able to evaluate all experiments by the rotations per minute. To make the experiments even more scientific, it makes sense to determine the measurement values additionally with a multimeter.

Then the measurement data can also be integrated into the measurement protocols and evaluated.

Parts list

- 2 x **Solar cells** mono SM330 0.5 V / 330 mA
- 1 x **Solar motor** RF300
- 4 x **Cable** with kroko clamps
- 5 x **Coloured foils**
- 5 x **Shading cover**
- 1 x **Instructions**
- 1 x **Wooden parts set:** Motor mounting with spiral disc
- 1 x **Wooden parts set:** Solar cell mounting with engraving
- 1 x **Wood glue**

Assembly motor mounting

Parts list

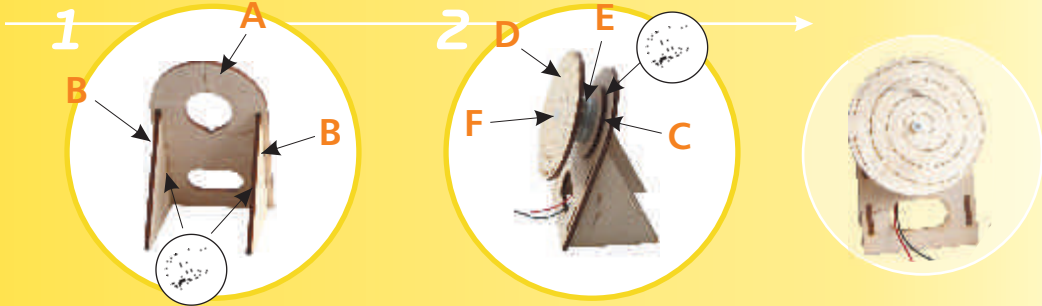
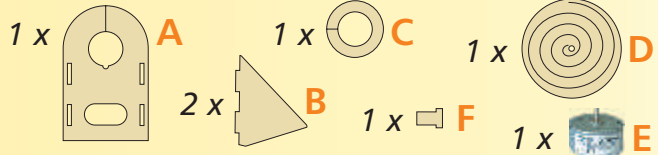

Assembly solar cell mounting

Parts list

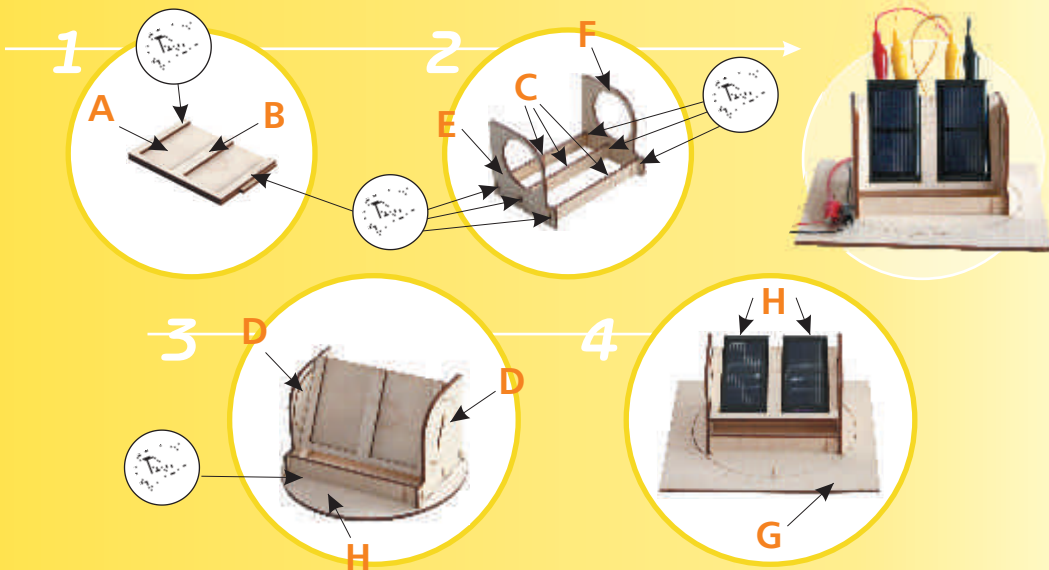
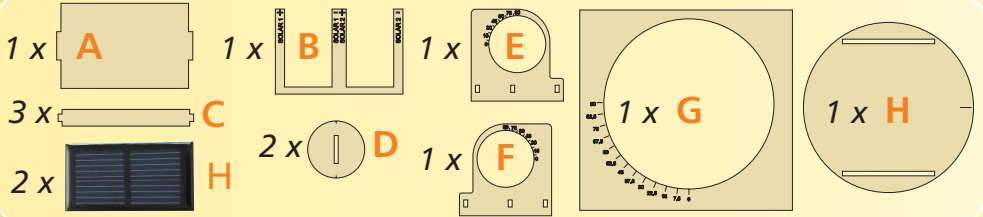

The sun

The sun has 333000 times the mass of the earth and the largest energy reservoir of our solar system. With a diameter of 1,392 million kilometres it is more than one hundred times as large as the earth.

The average distance from the earth to the sun is 150 million kilometres. Every day, rays of the sun reach us after a travel time of 8 minutes. The light travels a distance of 299792.5 km per second.

For example, if one were to send light from Lake Constance to Flensburg, this distance is approx. 1000 km, it would only need a split second, about 0.0035 seconds.

Technically speaking, the sun is no different than a huge gas ball.

An incredibly hot gas all and very explosive.

On the inside, the temperature measures up to 15 million degrees. On the surface the temperature still measures impressive 5700 degrees Celsius.

The temperature of the sun is difficult to describe. Let us try to imagine temperatures with the following list (see below).



This is how we can imagine how hot the sun actually is:

50, 60	degrees Celsius:
90-100	degrees Celsius:
100	degrees Celsius:
3000	degrees Celsius:
5700	degrees Celsius:
15000000	degrees Celsius:

The desert during the day.
The temperature in a sauna.
Water evaporates.
Metal melts within seconds.
The surface of the sun.
The temperature of the sun.

The temperatures and also the pressure on the inside of the sun are so high that there are atomic reactions. Due to these atomic reactions 4 million tons of matter are burned every second whereas every gramme of burnt matter creates 25 000 000 kWh of energy.

SUN ENERGY
Energy that humans must utilize!

The principle

The conversion of light into electrical energy is called photovoltaics. This term originates from Greek language and is composed of the two words "phos = light" and "Volt - unit of electrical current".

Photovoltaics was discovered already in by the French physicist Becquerel. However, the first solar cell was not developed until 100 years later in the Bell-laboratories.

This was in the year 1954.

And since this time scientists all over the world are trying to improve the efficiency of solar cells. Many million EUROS are spent annually on the research of this technology for this purpose. The target of the scientists is to improve the level of efficiency of the solar cells.

The level of efficiency

The measurement that determines the level of efficiency of a solar cell is done in a laboratory. Various specifications must be adhered to. The light insulation amounts to 1000 Watt/m² during measurement .

The cell temperature must measure 25 degrees Celsius.

In addition, the humidity is controlled. These specifications that all manufacturers must adhere to allow the comparison of different solar cells from different manufacture.

But what exactly is the level of efficiency?

The level of efficiency determines the ratio of entered energy and gained energy in percent. Example: If 1000 watts input power create an output power of 100 watts, the level of efficiency is 10%.

The different solar cells

The three solar cells that are currently in use:

Cell types	Material	Level of efficiency
Amorph cell	Steamed-on silicium layer	up to 7%
Polycrystalline cell	Silicium discs	up to 16%
Monocrystalline cell	Silicium discs	up to 20%

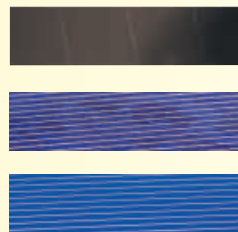

Regarding the price, the amorph solar cell is by far the lowest priced. However, it also loses a significant amount of performance after just a few years. Poly and monocrystalline solar cells on the contrary have the same performance also after many years (up to 25 years). These cells are slightly more expensive, but more cost effective due to their high longevity.

Material

The material that solar cells are made of is quartz sand. It is cleaned of contamination by a special procedure and then processed to a silicium block. Depending on the type of the cell, different procedures are necessary to do this.

The Czochralski crystal-pulling process is applied for monocrystalline cells. A silicium crystal is dipped into the hot, liquid silicium. The liquid silicium joins with the dipped-in silicium crystal, while it is slowly drawn back out of the pot.

This creates silicium sticks with a length of over 1 metre. On polycrystalline cells the hot silicium is poured into a mould and cooled off gradually. This method also creates silicium sticks.

Now these sticks that were created in both methods are cut into paper-thin layers (< 0,5 mm). Every disc is smoothed by cauterising and grinding.

Subsequently both sides are contaminated purposefully with different foreign atoms. This is called "doping".

Doping charges one side positively, and one side negatively, which later enables electric power to flow upon incidence of light.

The backside of the solar cell is coated with a very thin aluminium layer. This aluminium layer serves as positive pole.

The front side is also coated with aluminium, however not all the way, but only to form narrow conductor paths so that light can continue to reach the silicium.

Ultimately, a solder tail is created on the conductor paths that provides the second connection, the negative pole. Modern solar cells are 6" large.



Construction of a solar cell:

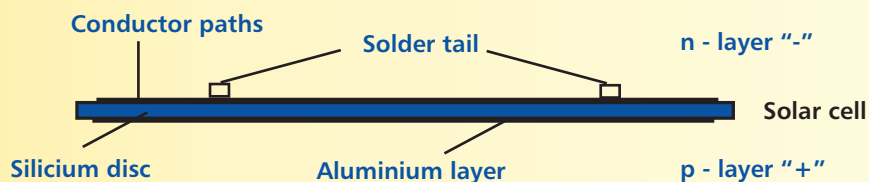

The function

The light consists of numerous tiny energy carriers, the photons. If these photons hit the solar cell, electrons are released on the n- layer.

The electrons now attempt to wander to the p - layer.

This wandering is called the **current flow**. This always takes place from - to +. If a consumer is connected to the solar cell, the wandering of the electron leads through the consumer and drives the motor axis of a motor, for example.

The conversion of light into electric energy:

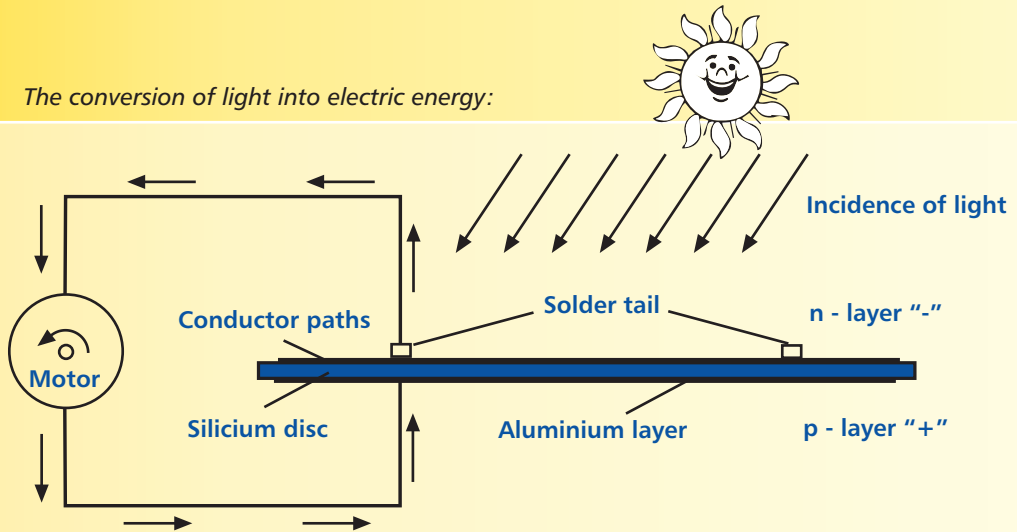

A solar cell produces direct current voltage. Depending on the quality of the cell this current may lie between 0.5 and 0.65 volt. The size of the solar cell determines the power.

Application examples of photovoltaics

Mainly solar modules are currently used in two unit types for power generation:

- Parallel operation
- Island operation

These two topics are described in more detail on the next pages.

Further example for the application of solar modules:

- Consumer products (s. Ill.)



Fig. Solar flashlight



Feed-in into the public power grid

Parallel connections serve the purpose of feeding power generated by photovoltaics into the public power grid. Such a parallel connection

consists of solar modules, a grid feeder, a main switch and if applicable a recording system for the evaluation of the feed-in data.

Unit scheme:

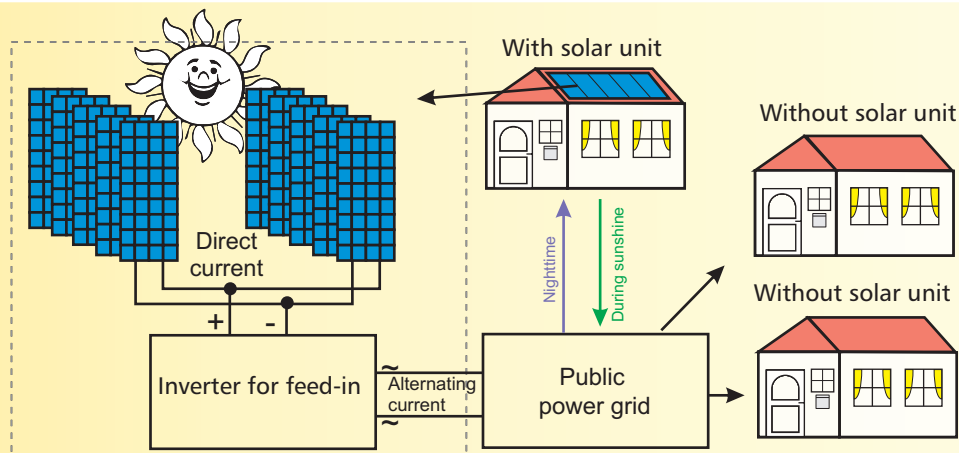

The inverter for feed-in converts the direct current into alternating current and feeds it into the public power grid.

If not enough energy is available through the solar unit, for example during nighttime or bad weather, the operator draws power out of the public power grid.

The operator receives 43.01 Cent for every kWh fed into the public power grid. This amount is valid for PV units on buildings or on noise barriers up to 30 kW. (Dated 6/2009)

Depending on the unit size and construction type these amounts may vary. You can find current values on the internet.



Copyright www.sunset-solar.com



Copyright www.sunset-solar.com

Power supply independent from the public power grid

Island units are used for places where there is no public power grid available. As it is the case for example in RV's, boats, or alpine cabins. In order to operate such an island unit one requires solar modules, charger regulators and batteries, and of course also consumers like lamps, radios or the like.

Unit scheme:

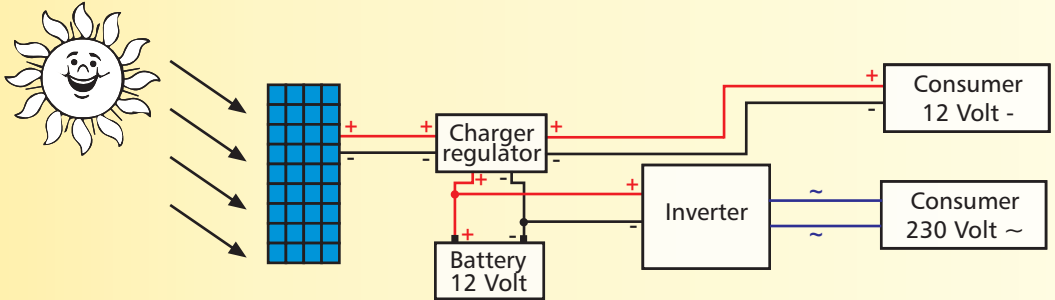

The solar module

The solar module usually consists of 36 single solar cells that are connected in parallel operation. The current strength of the cell is decisive for the total power.

The charge regulator

The charge regulator prevents the battery of becoming overcharged by the solar module, as this is very damaging to the battery. If the battery is loaded, the charge regulator separates the solar module from the battery. Good charge regulators also possess a deep discharge protection. The deep discharge protection ensures that the consumers only discharge the battery up to a certain preset voltage.

After that, the charge regulator automatically turns off the consumers. If the battery is now charged again over the solar module, the consumers are turned on again. In the usage of charge regulators without deep discharge protection deep discharge can happen repeatedly. This significantly reduces the lifetime of the battery.



Copyright www.phocos.com

The battery

The battery only serves as reservoir for the power that is created by the solar module. This way energy can be saved during daylight and can be obtained during the day or night.

The inverter

The inverter converts the battery voltage of 12 volt direct current into 230 volt alternating current. This way conventional 230 V-devices can be connected to the solar unit like for example TV, lamps, radio, etc.

Examples parallel connection



Photos:
Copyright www.sunset-solar.com



Examples island connection



Photos:
Peter Adelman

Notices:

Adequate source of light

Especially adequate as a source of light is the sunlight. In case of bad weather a desktop lamp with halogenous bulb can be used. The output of this lamp should be approx. 50 - 75 watts. Regarding the halogenous lamp the temperature development must be watched as these lamps can get very hot.

ATTENTION: Burning hazard!

Distance of the source of light to the solar cell (halogenous lamp)

We recommend a safety distance of approx. 30 cm to the solar cell.

ATTENTION: The long-term lower deviation may lead to defect of the solar cell!

Information for handling the solar cells

Solar cells are high quality semiconductor parts and sensitive to breaks.

This is why they need to be handled with care at all times.

Information about the multimeter (optional)

Read the operating instruction of the multimeter carefully and adhere to the contained safety instructions. Keep the instructions of the multimeter for the later use.

Measurement with a multimeter

In most cases the following measurement ranges need to be set:

Current measurement: 10 / 20 A, direct current

Voltage measurement: 2 Volt, direct current

Should the measurement results exceed the display, choose the next measurement range.

Visual measurement with the motor

In the measurement with the motor the rotations per minute are set visually and divided into different ranges as shown in the index below. In order to facilitate the estimation of the rotations per minute, the possible abbreviations of the rotations per minute are stated for each experiment.

These can therefore be determined and entered into the measurement value table.



Significance of abbreviation and rotation per minute:

Abbreviation	S	M	L	N	U
Rotation per minute	fast	medium	slow	does not rotate	Rotation direction changes

Voltage range = 2 V
 Current range = 10 / 20 A

...and their effects of the solar cell performance

Not every source of light is adequate for solar technology. The different sources of light that we want to use should have the same distance (approx. 30 cm) to the solar cells.

Different sources of light produce different performances in solar cells. The best source of light for photovoltaics is sunlight.

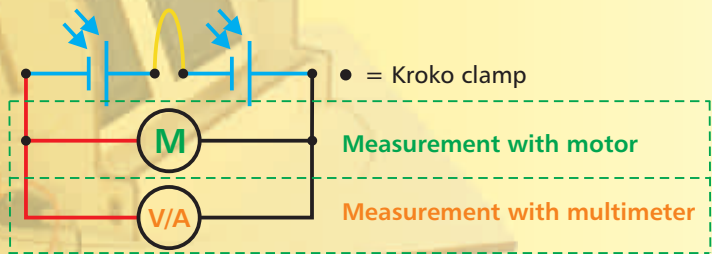
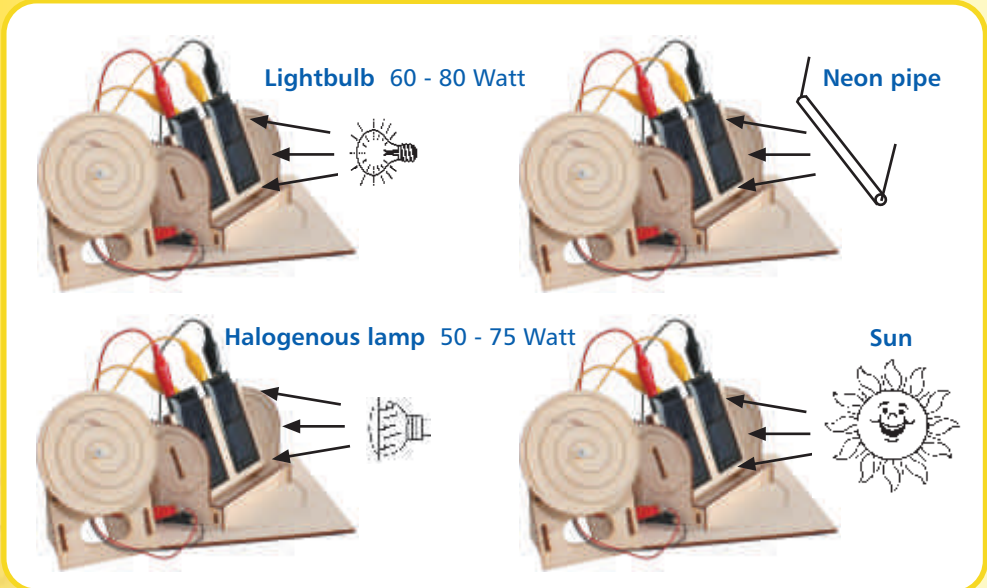

Please enter measurement values:

Source of light	Lightbulb	Neon pipe	Halogenous lamp	Sunlight
Voltage in V				
Power in mA				
Performance in W ($P = U \times I$)				
Motor turns (S/M/L/N)				

Effects of light filters

Voltage range	= 2 V
Current range	= 10 / 20 A

Conventional light filters in solar technology are mainly different conditions of cloudiness. The cloudiness range reaches from "clear sky" to light, medium, up to strong cloudiness

Different light spectrums are lost through the filtering of the light. Depending on the foil colour, different light spectrums are filtered out. Therefore the solar cell releases a respectively different performance.

Here is an experiment to explore the effect of light filters:

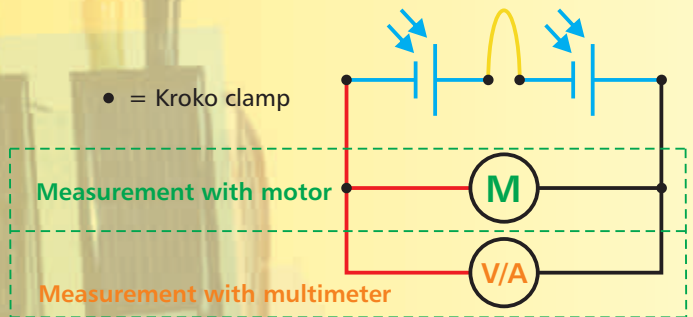
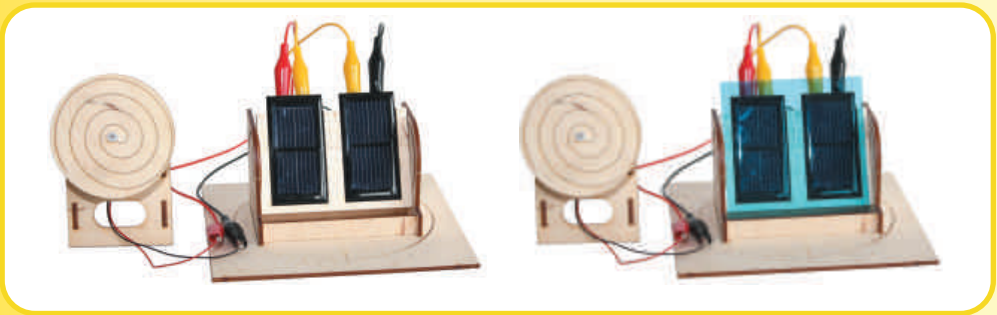

Please enter measurement values:

Colour of the foil	without foil	transparent	yellow	green	red	bleu
Voltage in V						
Power in mA						
Performance in W ($P = U \times I$)						
Motor turns (S/M/L/N)						

Voltage range	= 2 V
Current range	= 10 / 20 A

Series connection

In order to increase the voltage of a solar unit, single solar cells must be connected in series.

This is typical for example for standard modules, as they consists of 36 - 40 cells that are connected in series.

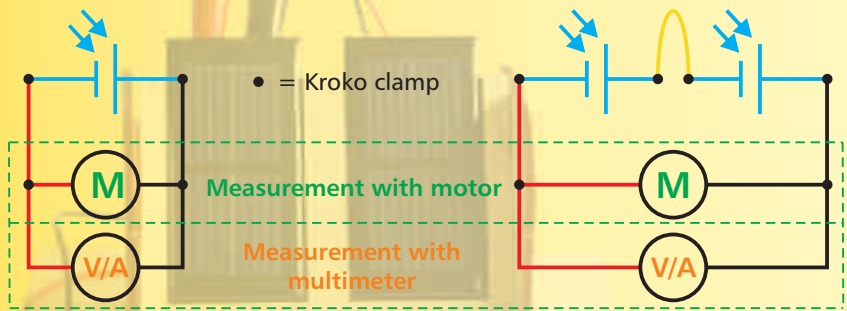
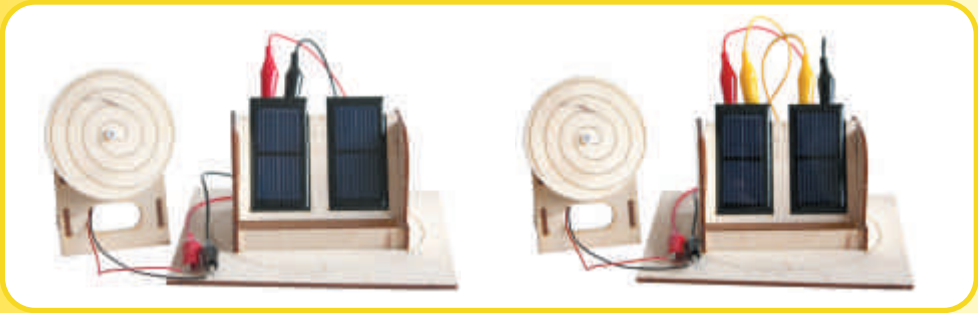

Please enter measurement values:

Number of solar cells	1 solar cell	2 solar cell
Voltage in V		
Power in mA		
Performance in W (P = U x I)		
Motor turns (S/M/L)		

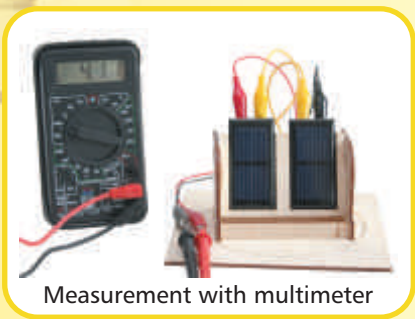

If solar cells are connected in series, the total voltage increases.

The formula for this is:

Voltage of the single cell x number of cells = Total voltage

Parallel connection

Voltage range	= 2 V
Current range	= 10 / 20 A

In order to increase the power of a solar module, single solar cells must be connect in parallel. To prove this, we create the following connection.

Please pay attention that only solar cells of the same type may be connected in parallel.

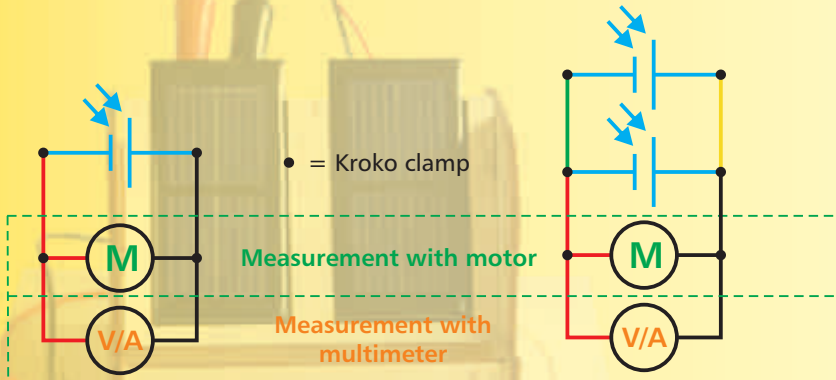

Please enter measurement values:

Number of solar cells	1 solar cell	2 solar cell
Voltage in V		
Power in mA		
Performance in W ($P = U \times I$)		
Motor turns (S/M)		

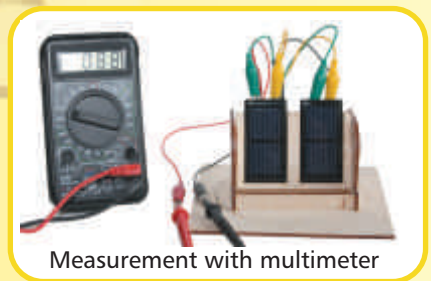

In this experiment the rotations per minute of the motor only change slightly. The torque of the axis however doubles, and thus also the total performance of the motor.

If a second solar cell is connected in parallel to a solar cell, the power doubles. The formula for this is:

Power of the single cell x number of cells = Total voltage

Cell shading

Voltage range = 2 V
 Current range = 10 / 20 A

Partial shading leads to significant performance loss of solar cells. We now want to determine the ratio of the percentual shading to the decrease in performance of the solar cells.

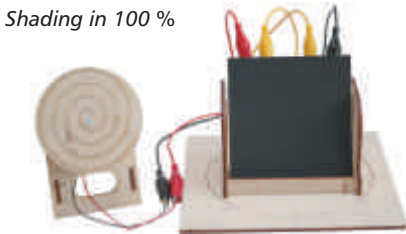
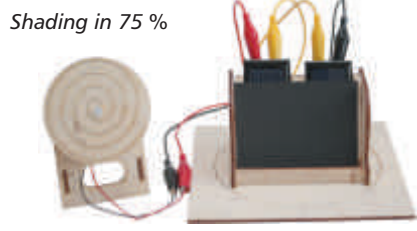
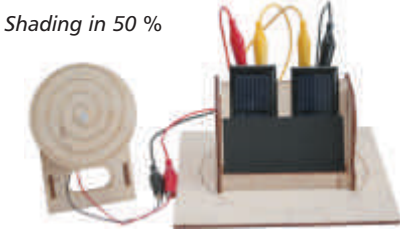
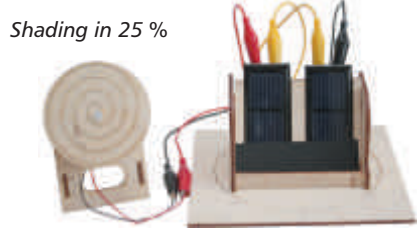
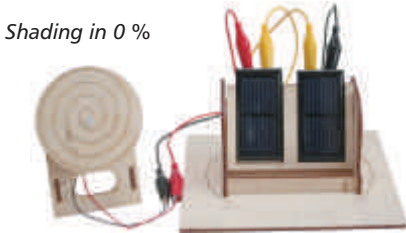

The more a solar cell is shaded, the less power it produces. Therefore, attention is always to be paid to select shade-free locations for solar modules.

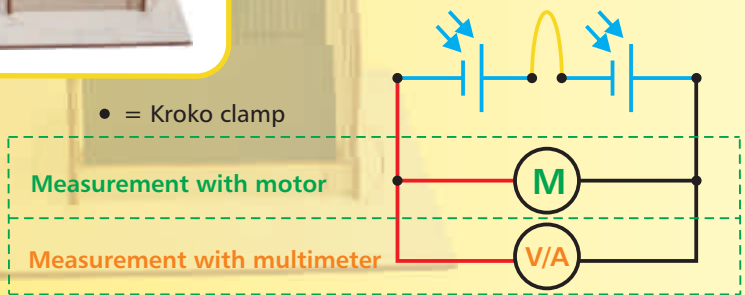

Please enter measurement values:

Shading in %	0	25	50	75	100
Voltage in V					
Power in mA					
Performance in W ($P = U \times I$)					
Motor turns (S/M/L/N)					

Cell shading

Voltage range	= 2 V
Current range	= 10 / 20 A

Cell shading in series connection lead to a total performance failure of the system as the shaded solar cell reaches a high inner resistance and thus significantly reduced the power flow.

This can be eliminated with the bypass diode! (see also page 20)

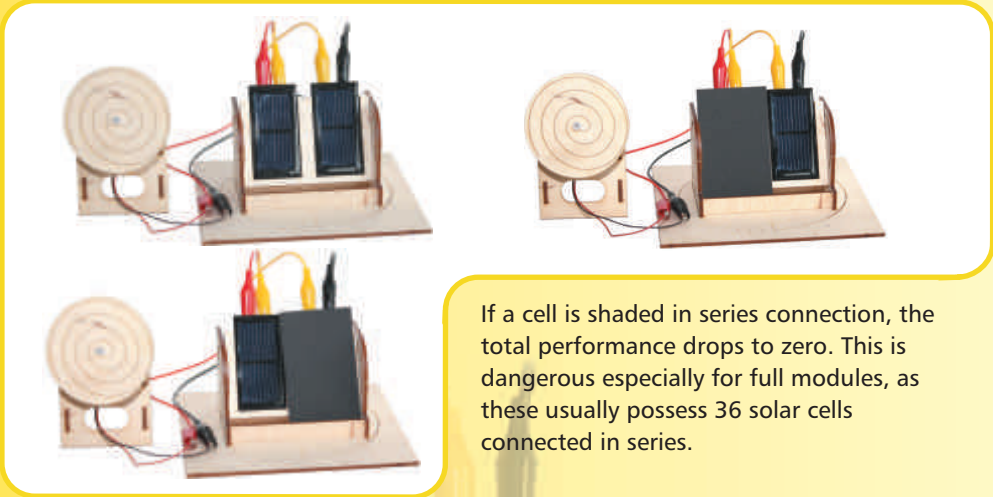

If a cell is shaded in series connection, the total performance drops to zero. This is dangerous especially for full modules, as these usually possess 36 solar cells connected in series.

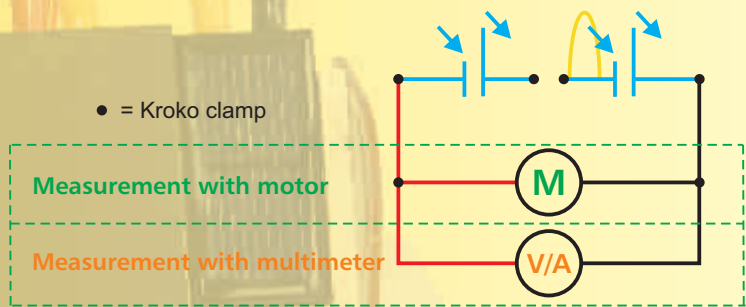

Please enter measurement values:

Shaded solar cell	no solar cell	left solar cell	right solar cell
Voltage in V			
Power in mA			
Performance in W ($P = U \times I$)			
Motor turns (S/N)			

Voltage range = 2 V
 Current range = 10 / 20 A

Cell shading

Partial shading in parallel connection of solar cells lead to a loss of performance, but not to a total performance failure of the system. We will now prove this with an experiment.

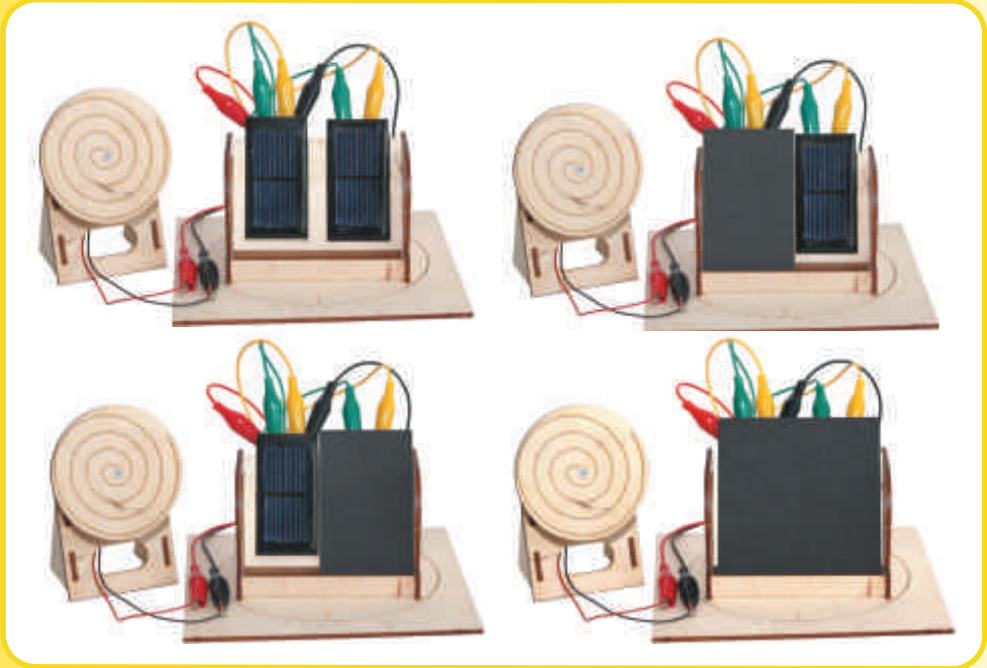

If a solar cell is shaded in parallel connection, the total performance is reduced by this solar cell performance.

Only if all solar cells are shaded does the total performance go back to zero.

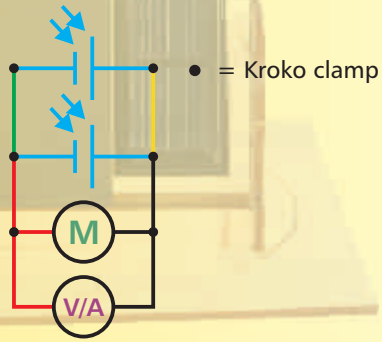

Please enter measurement values:

Shaded solar cell	no solar cell	left solar cell	right solar cell	both solar cells
Voltage in V				
Power in mA				
Performance in W ($P = U \times I$)				
Motor turns (S/M/L/N)				

1

The scenario:

A leaf falls onto a single cell of a solar module.

What happens to the total performance of the module?

A solar module in a unit network is massively contaminated or there are leaves on it, for example. The solar module now generates significantly less power.

This would cause the total performance of the network to be significantly impeded.

To avoid this, a bypass diode is built into every solar module. This way the solar module that does not supply any more power is removed from the network, and the power generated by the network is led past the module through the diode.

This also prevents that this module heats up strongly and is damaged by the high temperatures. This strong heating is also called the **Hot-Spot-Effect**.



Photos: Copyright www.sunset-solar.com



2

Window panes also filter different frequencies of the sunlight. It is completely normal that e.g. solar toys work better outside than inside a room.

It may be helpful to open a window.



Voltage range = 2 V
 Current range = 10 / 20 A

Horizontal tracking

This experiment shows that different roof inclines produce different performances of the solar cells. The angle "roof incline" can be read on the side of the solar cell mounting. **Important: The lamp light must come directly from the front!**

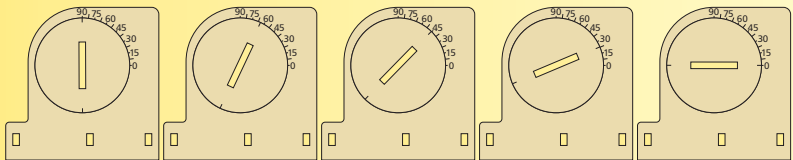
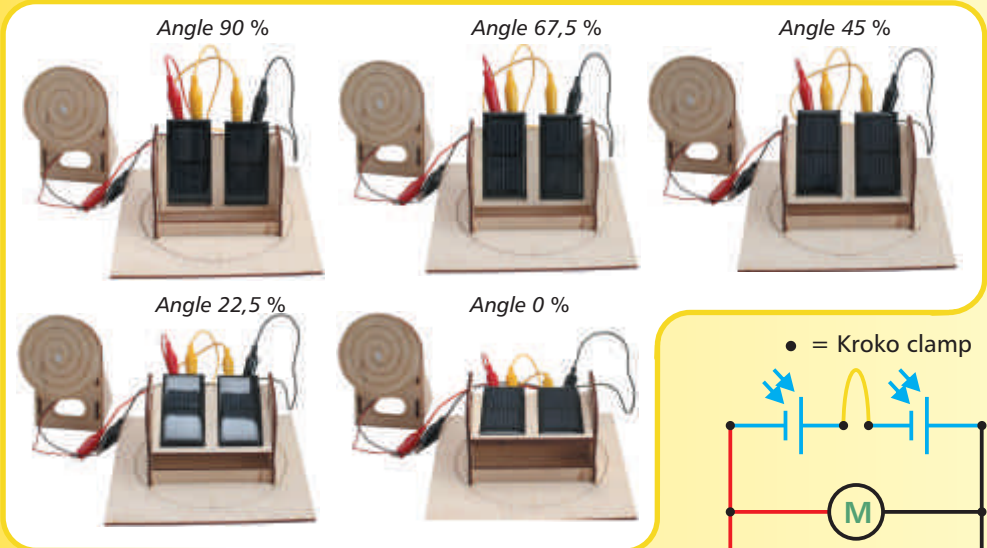

Please enter measurement values:

Angle to the light in %	90	67,5	45	22,5	0
Voltage in V					
Power in mA					
Performance in W (P = U x I)					
Motor turns (S/M/L/N)					

A solar module will have ideal performance if it is positioned in a 90 degree angle to the source of light (sun). If e.g. solar modules are adjusted to the horizontal position of the sun during wintertime, this produced higher exploitation and thus higher profit in parallel connections.

Vertical tracking

Voltage range	= 2 V
Current range	= 10 / 20 A

Is it profitable to track a solar unit vertically to the sun?
And how is the ratio angle - performance?

An interesting experiment with a **spectacular result**.

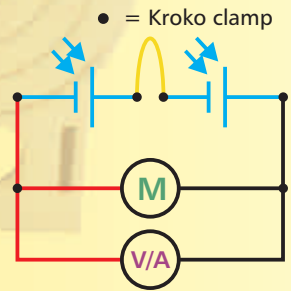
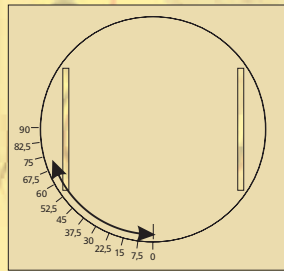
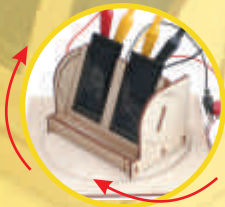
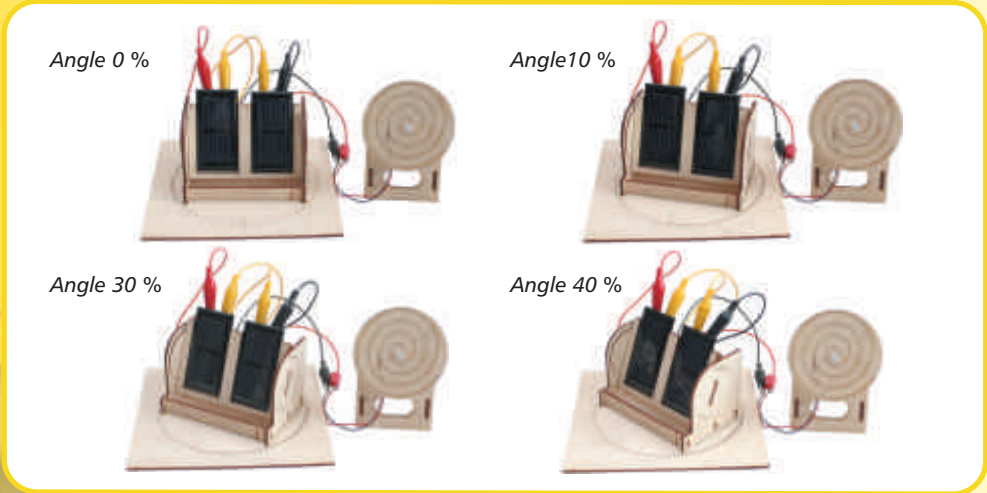

Please enter measurement values:

Angle to the light in %	0	10	20	30	40
Voltage in V					
Power in mA					
Performance in W ($P = U \times I$)					
Motor turns (S/M/L/N)					

If a solar unit tracks the sun, the total profit of the unit increases by up to **50%**. The additional costs accruing due to the tracking are balanced within a short time with the additional profit.



Further products from the SOL-EXPERT group:



Solar seagull
17 x 11 cm
Art. no.: 46006



Solar windmill
Höhe: ca. 20 cm
Art. no.: 40009



Solar cricket
5 x 2.5 x 1.5 cm
Art. no.: 46002

One of the smallest solar cars



Solar Mini car
3.2 x 1.5 x 2.2 cm
Art. no.: SMA



Solar flashlight
6 x 3.5 x 1.1 cm
Art. no.: STL

SOL-EXPERT group

Albersfelder Straße 8, D- 88213 Ravensburg

Phone: +49 (0)751 / 769 24 37-0, Fax: +49 (0)751 / 769 24 37-9

Email: info@sol-expert-group.de

www.sol-expert-group.de