

# Eight channel remote relay card

This relay card can be used in several ways :  
stand alone card, addressed by switches or open  
collector outputs or remote controlled through  
RS232.

Total solder points: 277

Difficulty level: *beginner* 1  2  3  4  5  *advanced*

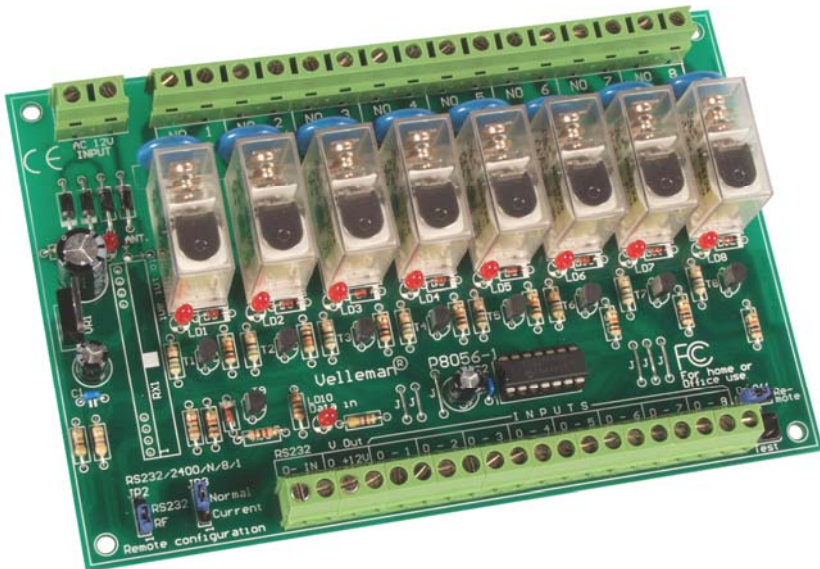

# K8056

This device complies with Part 15 of the FCC Rules provided the enclosed instructions are followed to the letter. Use of the device is subject to the following conditions: (1) this device must not cause harmful interference and (2) the operation of this device should not be influenced by unwanted interference.

More information about FCC can be look at <http://www.fcc.gov>



This relay card can be used in several ways:  
Stand alone card, addressed by switches or open collector outputs.

Remote controlled through RS232.

In option remote controlled using RF (radio frequency) signals and K8058 remote control+ RX433 module

Since the card can be addressed using RS232 commands, you may write custom applications in any language you want or on any platform you want.

Test software can be downloaded from our web site.

**Features :**

- ☑ Eight high quality relay contacts, 5A/230VAC max.
- ☑ Relay outputs are transient suppressed using VDR's.
- ☑ LED confirmation on each relay contact.
- ☑ Eight drive inputs to use with open collectors or regular switches.
- ☑ RS232 input to drive the card with computer or terminal.  
High or low impendant selection (10K or 1K).
- ☑ Optional RF driving possibility using RX433 type module(\*). Together with K8058 eight channel RF remote control.

**Specifications**

- Power: 12Vac / 500mA (including 12V output)
- Unregulated 12Vdc / 200mA power output

**Diagnostic / test software**

- ✔ Separate relay on/off test with moment or toggle function.
- ✔ Clear all / set all relays function.
- ✔ Address selection, up to 255 cards can be selected.
- ✔ Emergency stop for all cards.

**Minimum system for test software :**

- Pentium class CPU
- Windows 95 or higher
- Mouse and free RS232 port

\* Not simultaneous with RS232

## 1. Assembly (Skipping this can lead to troubles !)

Ok, so we have your attention. These hints will help you to make this project successful. Read them carefully.

### 1.1 Make sure you have the right tools:

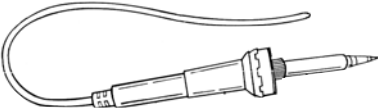
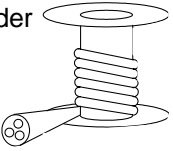
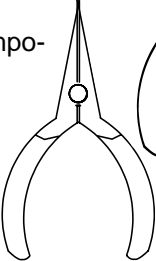
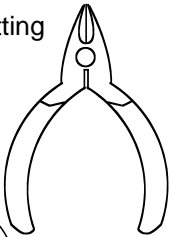
- A good quality soldering iron (25-40W) with a small tip. 
- Wipe it often on a wet sponge or cloth, to keep it clean; then apply solder to the tip, to give it a wet look. This is called 'thinning' and will protect the tip, and enables you to make good connections. When solder rolls off the tip, it needs cleaning.
- Thin raisin-core solder. Do not use any flux or grease. 
- A diagonal cutter to trim excess wires. To avoid injury when cutting excess leads, hold the lead so they cannot fly towards the eyes.
- Needle nose pliers, for bending leads, or to hold components in place. 
- Small blade and Phillips screwdrivers. A basic range is fine. 



**For some projects, a basic multi-meter is required, or might be handy**

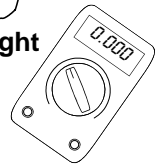

### 1.2 Assembly Hints :

- ⇒ Make sure the skill level matches your experience, to avoid disappointments.
- ⇒ Follow the instructions carefully. Read and understand the entire step before you perform each operation.
- ⇒ Perform the assembly in the correct order as stated in this manual
- ⇒ Position all parts on the PCB (Printed Circuit Board) as shown on the drawings.
- ⇒ Values on the circuit diagram are subject to changes.
- ⇒ Values in this assembly guide are correct\*

- ⇒ Use the check-boxes to mark your progress.
- ⇒ Please read the included information on safety and customer service

\* Typographical inaccuracies excluded. Always look for possible last minute manual updates, indicated as 'NOTE' on a separate leaflet.

### 1.3 Soldering Hints :

1- Mount the component against the PCB surface and carefully solder the leads

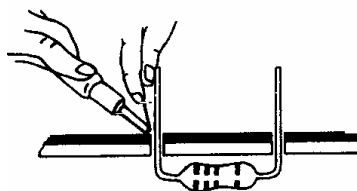

2- Make sure the solder joints are cone-shaped and shiny

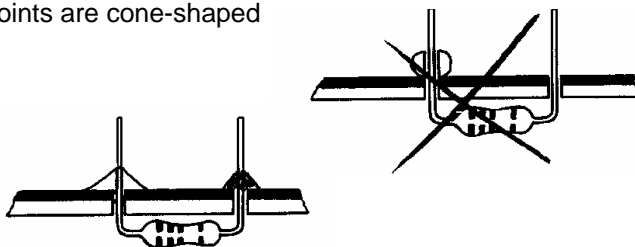

3- Trim excess leads as close as possible to the solder joint

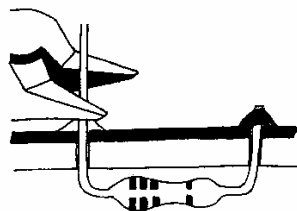

**AXIAL COMPONENTS ARE TAPED IN THE CORRECT MOUNTING SEQUENCE !**

REMOVE THEM FROM THE TAPE ONE AT A TIME !

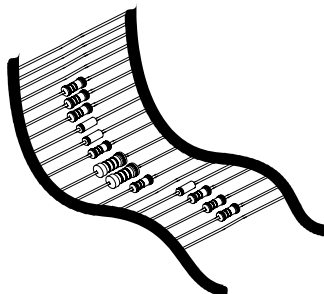

### 1. Jump wires.

J (6x)

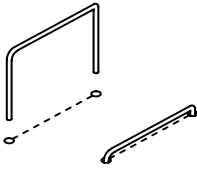

### 2. Diodes (check the polarity)

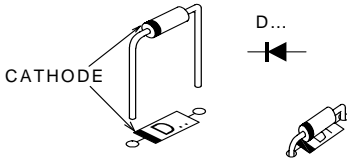

- D5 : 1N4148
- D6 : 1N4148
- D7 : 1N4148
- D8 : 1N4148
- D9 : 1N4148
- D10 : 1N4148
- D11 : 1N4148
- D12 : 1N4148

### 3. Zener diode (check the polarity)

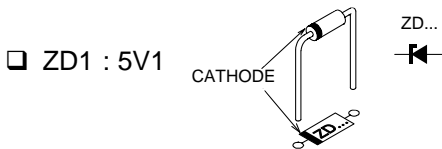

ZD1 : 5V1

### 4. Resistors.

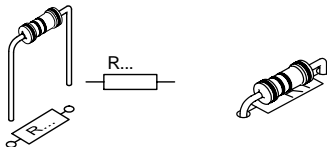

- R1 : 1K (1-0-2-B)
- R2 : 10K (1-0-3-B)
- R3 : 56 (5-6-0-B)
- R4 : 56 (5-6-0-B)
- R5 : 10K (1-0-3-B)
- R6 : 56 (5-6-0-B)
- R7 : 10K (1-0-3-B)

- R8 : 56 (5-6-0-B)
- R9 : 10K (1-0-3-B)
- R10 : 56 (5-6-0-B)
- R11 : 10K (1-0-3-B)
- R12 : 56 (5-6-0-B)
- R13 : 56 (5-6-0-B)
- R14 : 56 (5-6-0-B)
- R15 : 10K (1-0-3-B)
- R16 : 10K (1-0-3-B)
- R17 : 10K (1-0-3-B)
- R18 : 1K (1-0-2-B)
- R19 : 470 (4-7-1-B)
- R20 : 4R7 (4-7-B-B)
- R21 : 4R7 (4-7-B-B)
- R22 : 1K (1-0-2-B)
- R23 : 10K (1-0-3-B)
- R24 : 1K (1-0-2-B)

### 5. Diodes (check the polarity)

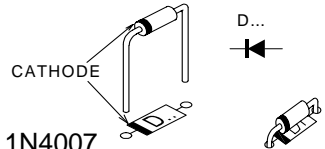

- D1 : 1N4007
- D2 : 1N4007
- D3 : 1N4007
- D4 : 1N4007

### 6. Push button

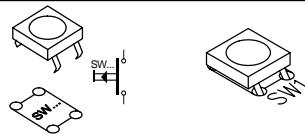

SW1 : Test (KRS0612)

### 7. Capacitors



- C1 : 100n (104, 0.1, u1)
- C2 : 100n (104, 0.1, u1)

### 8. IC sockets. Watch the position of the notch!

IC1 : 14p

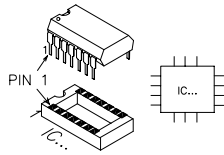

### 9. LEDs. Watch the polarity!

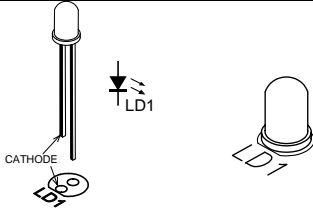

- LD1
  - LD2
  - LD3
  - LD4
  - LD5
  - LD6
  - LD7
  - LD8
  - LD9
  - LD10
- } 3mm RED

LD1 ... LD8 : Output indication  
 LD9 : Power indication  
 LD10 : DATA indication

### 10. Transistors

- T1
  - T2
  - T3
  - T4
  - T5
  - T6
  - T7
  - T8
  - T9
- } BC547B

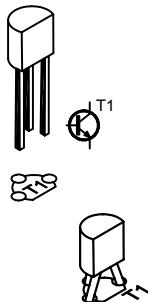

### 11. Header

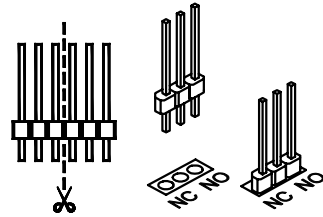

- JP1 : 3p "ON/OFF remote"
- JP2 : 3p "RS232/RF"
- JP3 : 3p "Normal/Current"

### 12. Electrolytic capacitors. Watch the polarity!

- C3 : 100µF
- C4 : 100µF

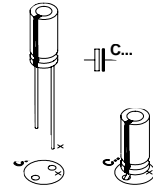

### 13. Screw connectors

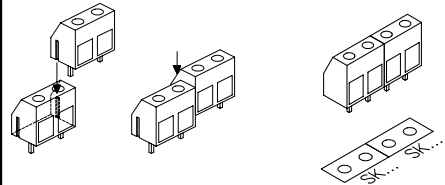

**ATTENTION** : SK2 to SK9 are 7,5mm pitch connectors, SK12 to SK19 are 5mm pitch connectors!

- SK1 : 2p => (AC 12V input)
  - SK2 : 2p
  - SK3 : 2p
  - SK4 : 2p
  - SK5 : 2p
  - SK6 : 2p
  - SK7 : 2p
  - SK8 : 2p
  - SK9 : 2p
- } Output 1 ... 8

- SK10 : 2p => RS232 input
  - SK11 : 2p => V Out 12V
  - SK12 : 2p
  - SK13 : 2p
  - SK14 : 2p
  - SK15 : 2p
  - SK16 : 2p
  - SK17 : 2p
  - SK18 : 2p
  - SK19 : 2p
- } Input 1 ... 8

**14. VDR's**

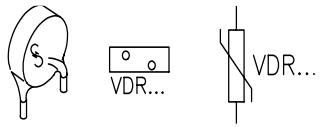

- VDR1
  - VDR2
  - VDR3
  - VDR4
  - VDR5
  - VDR6
  - VDR7
  - VDR8
- } VDR300 (300VAC/385VDC)

**15. Voltage regulator**

- VR1 : UA7805

☞ Check the orientation !

**16. Electrolytic capacitor. Watch the polarity !**

- C5 : 1000µF

**17. Relays**

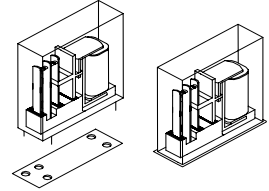

- RY1
  - RY2
  - RY3
  - RY4
  - RY5
  - RY6
  - RY7
  - RY8
- } VR10V121C

**18. IC. Watch the position of the notch!**

- IC1 : VK8056 programmed Pic16F630 or eq.



## 19. Control options

### 1) RS232 cable :

- |                |
|----------------|
| <b>9 pole</b>  |
| 3 : TxD        |
| 5 : GND        |
| <b>25 pole</b> |
| 2 : TxD        |
| 7 : GND        |

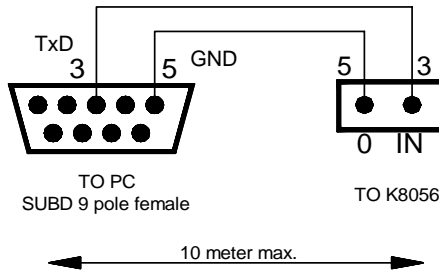

10 meter max.

**Do not use a null-modem cable !!**

#### Jumper setting :

- Place JP1 in ON position
- Place JP2 in RS232 mode, see fig 1.0.
- Choose the impedance, high or low with JP3. Define the impedance on experimental use. The impedance depends on the length of RS232 cable you're using.

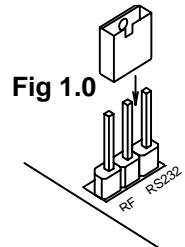

Normally the impedance is 10Kohm => select normal.

If you use current loop (long cable), select current. The impedance will be 1Kohm.

Normal	Current
10K	1K

### 2) Wireless link :

It is possible to use the K8056 together with a remote control (e.g. our K8058). In this case an optional receiver module type **RX433** is available.

The receiver module is mounted on the left hand side of the K8056 board. Watch the position, the coil point to the relays of the K8056. If you choose wireless operation, make sure to set jumper JP1 & JP2 in right position.

Transmission quality depends on your environment. Other RF sources might interfere with your signal.

#### Jumper setting :

- Place JP2 in RF mode.
- Place now JP1 in ON position (see fig. 2.0)

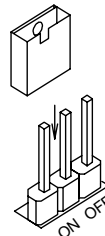

Fig 2.0

Put JP1 in OFF mode if you don't use a remote control (RS232 or wireless link)

## 20. Addressing the K8056 card through RS232 commands.

**Note:** A Test program can be downloaded from our web site.  
The source code (VB) is also available. (English only)

### **1) Instructions for software design :**

As the instructions consist of a string of ASCII characters, it is easy to design software which transmits the instructions via the serial port of the PC.

Port settings are: 2400/8/N/1

- For wired operation, the instruction sequence needs to be sent at least twice.
- For wireless operation, we recommend to send the instruction string at least 5 times in a row to ensure proper reception under all conditions. For improved reliability, add a pause of a least 300ms between two different instructions.

☝ Please note that environmental conditions can interfere with the signal.  
Therefore, the unit is not suited for use as or as part of any kind of equipment which might cause harm to people or property if a malfunction should occur.

### **2) Instruction sequence :**

To execute a command, the correct sequence needs to be sent to the K8056. Basically, a command sequence looks like this :

1. CHR\$(13)
2. card address (1..255)
3. instruction
4. address (1..255) or relay# ('1'..'9' ASCII)
5. checksum (2-complement of the sum of the 4 previous bytes + 1)

### **3) Instructions :**

- 'E' : Emergency stop all cards, regardless of address. Carefull, relays turned on by open collector inputs will not be turned off by this command).
- 'D' : Display address. All cards show their current address in a binary fashion. (LD1 : MSB , LD8 : LSB)
- 'S' : Set a relay. 'S'-instruction should be followed by relay # '1' to '8'. ('9' sets all relays at once).
- 'C' : Clear a relay. 'C'-instruction should be followed by a relay # '1' to '8'. ('9' clears all relays at once.)
- 'T' : Toggle a relay. 'T'-instruction should be followed by a relay # '1' to '8'.

- 'A'** : Change the current address of a card. 'A'-instruction should be followed by the new address (1..255)
- 'F'** : Force all cards to address 1 (default)
- 'B'** : Send a byte. Allows to control the status of all relays in one instruction, by sending a byte containing the relay status for each relay. (MSB : relay1, LSB : relay8)
- 4. Program example :** see Velleman site ([www.velleman.be](http://www.velleman.be))

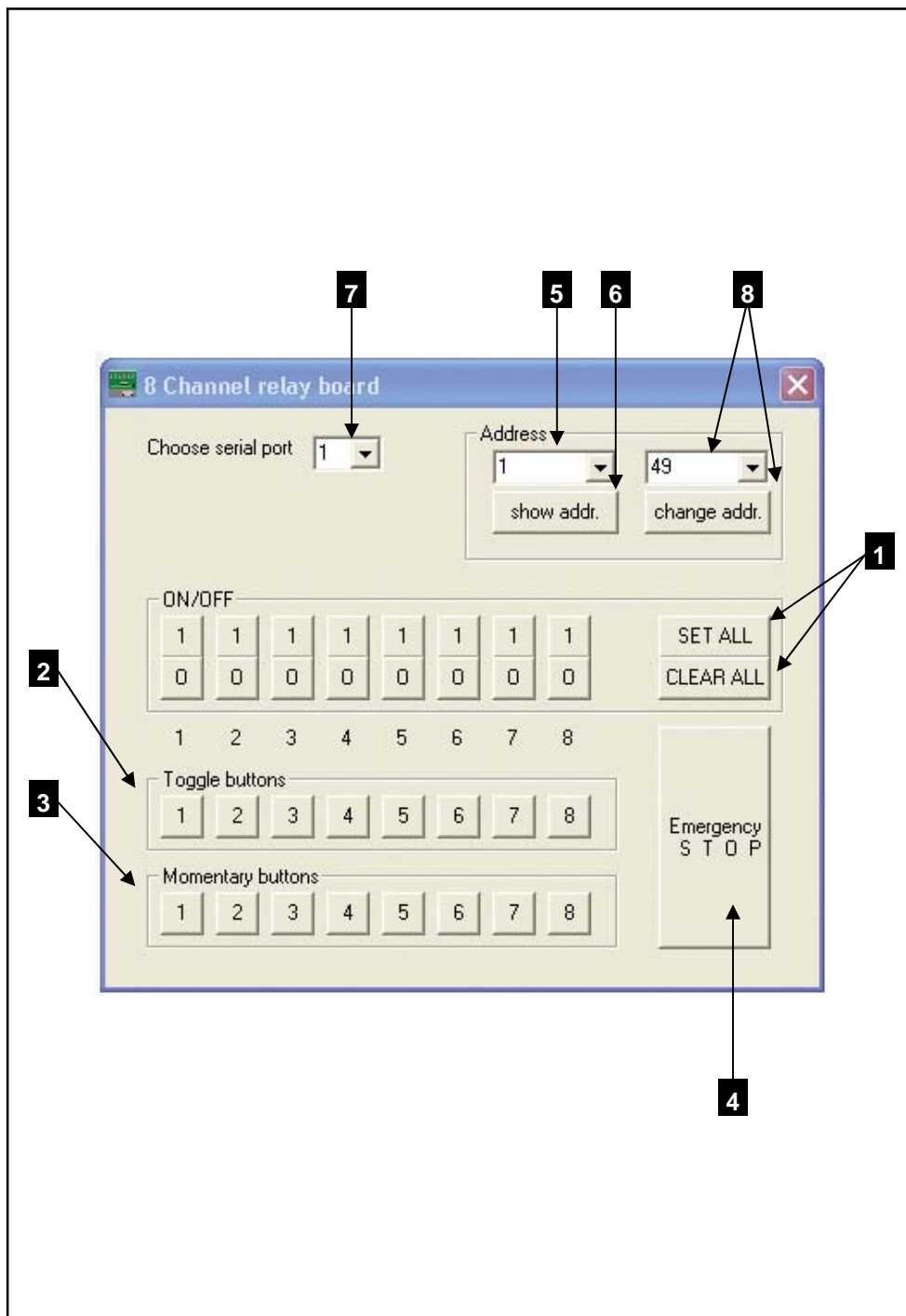

## 21. DIAGNOSTIC / TEST SOFTWARE

**Note :** You can download software from our website [www.velleman.be](http://www.velleman.be) which makes it very easy to control your relay card(s).

### A. Operating modes:

The K8056 features 4 operating modes :

1. Set all outputs active / non-active ❶
2. Eight toggle buttons ❷
3. Eight momentary buttons ❸
4. One button is reserved as 'emergency' function ❹

**Momentary :** Hold the key to activate the output and release the key to deactivate it.

**Toggle :** Operates according to the principal of a classic switch, i.e. press a key once to activate and press again to deactivate.

Emergency function : Deactivate all the outputs on the same time.

### B. Address selection:

1. Select the address of the relay card you want to control. ❺
2. Confirm the selection by clicking the "show addr." button. ❻



**NOTE :** Make sure that you have selected the correct serial port! ❼

### C. Changing address :

Choose the address you want to allocate to the relay card and confirm it by clicking the "Chang addr." button. ❽

## 22. PCB

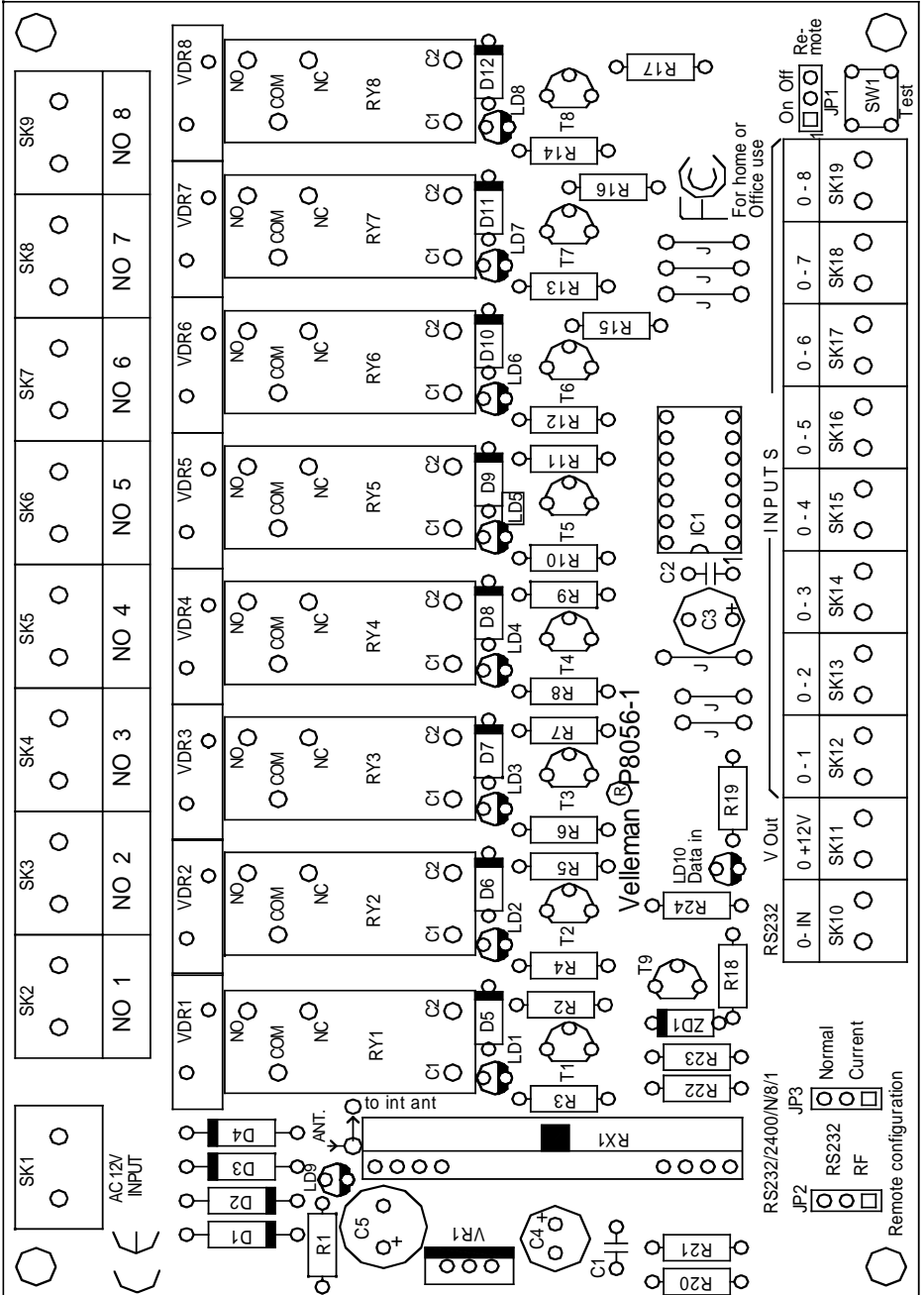

### 23. Schematic diagram

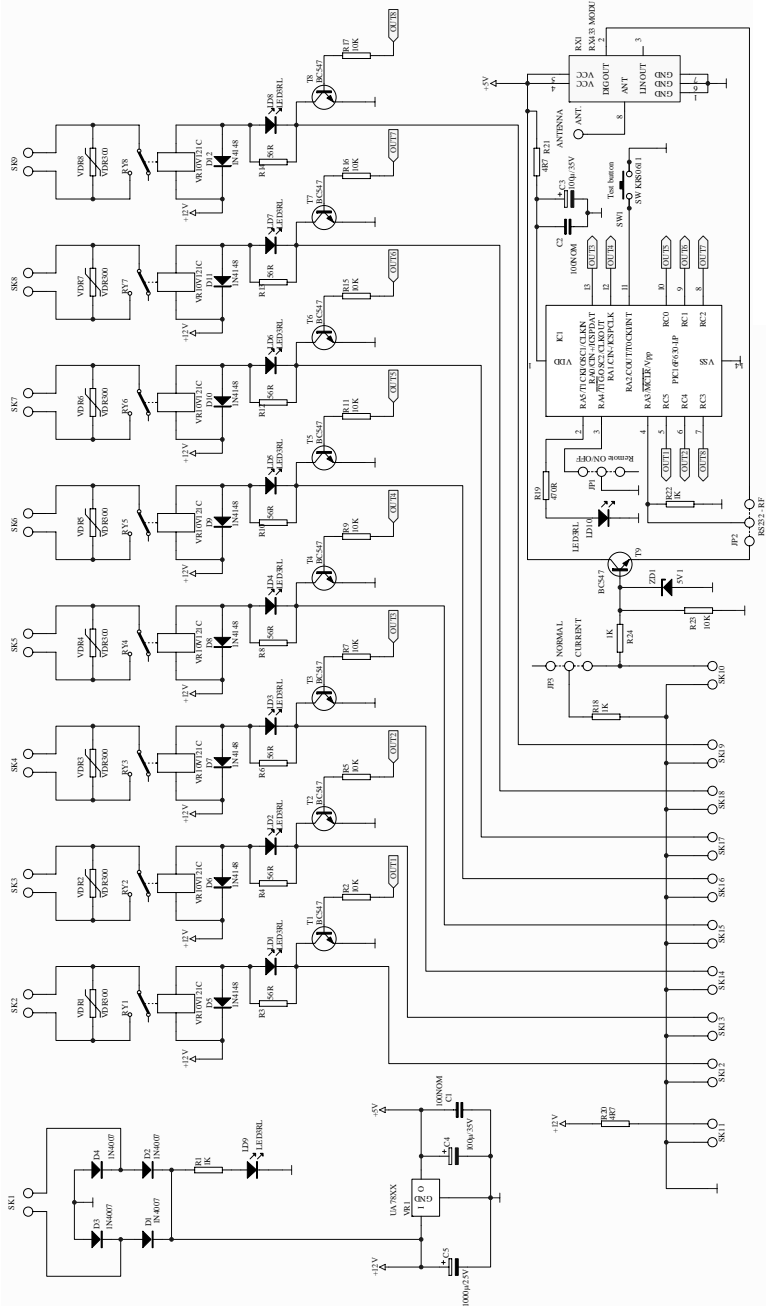



**VELLEMAN KIT NV**  
**Legen Heirweg 33**  
**9890 Gavere**  
**Belgium Europe**  
**Info ? : <http://www.velleman.be>**

Modifications and typographical errors reserved  
© Velleman Kit nv  
H8056IP - 2004 - ED1

