

Total solder points: 47
Difficulty level: *beginner* 1 2 3 4 5 *advanced*

METAL DETECTOR

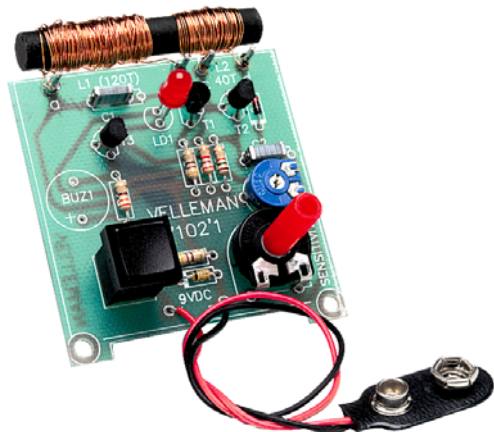

K7102

*“Avoid disasters when drilling
holes in walls...”*

To come up against an electric cable while drilling a hole in a wall can have catastrophic consequences. Likewise, drilling into gas, water pipes or central heating pipes can be extremely hazardous. With a handy metal detector it can now be determined beforehand whether there are metal objects to be found in a wall, ceiling or floor. An LED indicates if a metal object is in the vicinity. If an audio signal is also desired, space has been provided on the PCB for buzzer type SV4/12-S to be connected. The PCB has been specially constructed to fit entirely into the separately available box type G407.

Specifications:

- Avoid disasters when drilling holes in walls
- Locate pipes, cables, metal studs, ...
- Great project for novices
- Your own unique application
- Push button operation

Features:

- Detection range adjustable up to 8cm/ 3.1"
- Power supply : 9V battery
- Power consumption : 30mA max.
- LED indicator (Buzzer SV4/12AS optional)
- Dimensions : 55x64mm / 2.2"x2.5"
- Optional enclosure : G407

1. Assembly (Skipping this can lead to troubles !)

Ok, so we have your attention. These hints will help you to make this project successful. Read them carefully.

1.1 Make sure you have the right tools:

- A good quality soldering iron (25-40W) with a small tip.
- Wipe it often on a wet sponge or cloth, to keep it clean; then apply solder to the tip, to give it a wet look. This is called 'thinning' and will protect the tip, and enables you to make good connections. When solder rolls off the tip, it needs cleaning.
- Thin raisin-core solder. Do not use any flux or grease.
- A diagonal cutter to trim excess wires. To avoid injury when cutting excess leads, hold the lead so they cannot fly towards the eyes.
- Needle nose pliers, for bending leads, or to hold components in place.
- Small blade and Phillips screwdrivers. A basic range is fine.

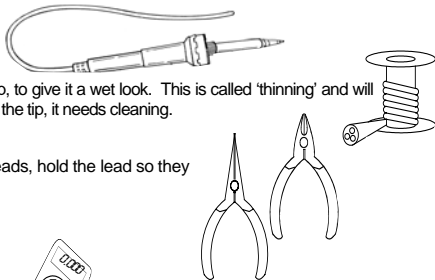

For some projects, a basic multi-meter is required, or might be handy



1.2 Assembly Hints :

- ⇒ Make sure the skill level matches your experience, to avoid disappointments.
 - ⇒ Follow the instructions carefully. Read and understand the entire step before you perform each operation.
 - ⇒ Perform the assembly in the correct order as stated in this manual
 - ⇒ Position all parts on the PCB (Printed Circuit Board) as shown on the drawings.
 - ⇒ Values on the circuit diagram are subject to changes.
 - ⇒ Values in this assembly guide are correct*
 - ⇒ Use the check-boxes to mark your progress.
 - ⇒ Please read the included information on safety and customer service
- * Typographical inaccuracies excluded. Always look for possible last minute manual updates, indicated as 'NOTE' on a separate leaflet.

1.3 Soldering Hints :

1- Mount the component against the PCB surface and carefully solder the leads

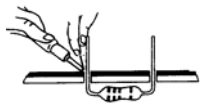

2- Make sure the solder joints are cone-shaped and shiny



3- Trim excess leads as close as possible to the solder joint

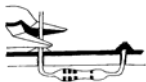

REMOVE THEM FROM THE TAPE ONE AT A TIME !

AXIAL COMPONENTS ARE TAPED IN THE CORRECT MOUNTING SEQUENCE !

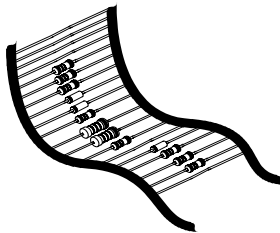

1. Coils

The coil consists of two windings around the ferrite core supplied.

In order to facilitate winding, thin double sided sticky tape can be stuck to the ferrite core, each winding can be held down using ordinary sellotape.

Both windings must be wound in the same direction (see fig 1.0)

- Winding L1 = 120 turns
(this winding can be marked with a sticky label)
- Winding L2 = 43 turns.

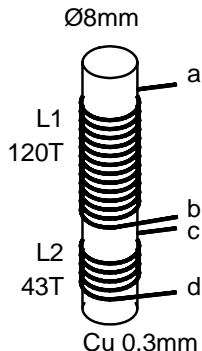
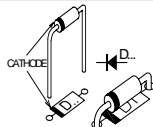

Fig. 1.0

2. Diode. Watch the polarity !

- D1 : 1N4148



3. Zenerdiode. Watch the polarity !

- ZD1 : 3V9

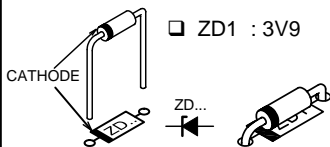

4. Resistors

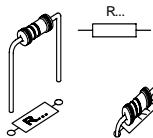

- R1 : 330 (3 - 3 - 1 - B)
- R2 : 470 (4 - 7 - 1 - B)
- R3 : 470 (4 - 7 - 1 - B)
- R4 : 2K7 (2 - 7 - 2 - B)
- R5 : 10K (1 - 0 - 3 - B)

5. Capacitors.

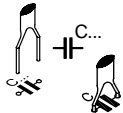
**Choose C1 :**

- C1 : 1n2 (122)
- C1 : 3n3 (332)
- Experiment for best result.
- C2 : 47nF (473)

6. Transistors.

- T1 : BC547B
- T2 : BC547B
- T3 : BC547B

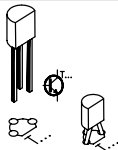

7. LED. Watch the polarity!

- LD1 : 5mm RED

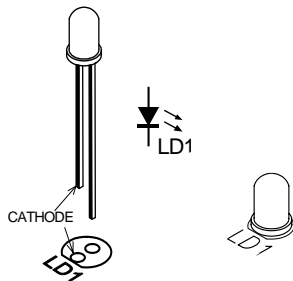

8. Trim potentiometers

- RV1 : 2K5
- RV2 : 100

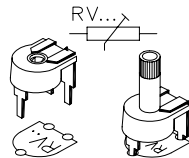

9. Push button

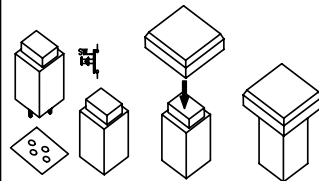

- SW1

10. Assembly

- ❑ Connect the battery terminal to the point marked “+” (red) and “-” (black), see figure 2.0.

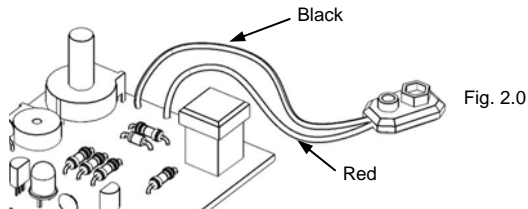

- ❑ Connect the windings to their respective points marked with a, b, (L1) and c, d (L2), see figure 3.0.

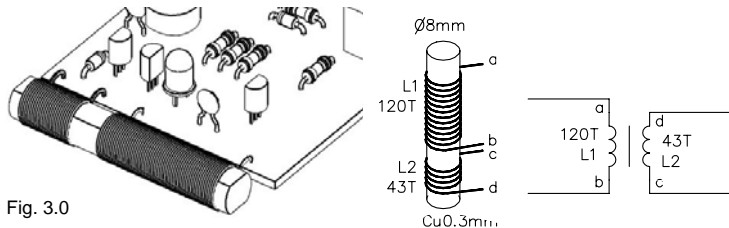

11. Test & final adjustments

1. Connect a 9V battery to the battery holder.
2. Go to a place where NO metal object is known to be in the vicinity.
3. Turn preset RV1 fully clockwise.
4. Turn RV2 fully anti-clockwise.
5. Depress the push button and hold it in during the final adjustments.
6. Turn RV1 anti-clockwise until the LED goes out.

☞ All further remaining adjustments are now concerned with RV2 only.

To set to maximum sensitivity: turn RV2 until the LED is weakly lit. When the detector now comes into the vicinity of a metal object, the LED will be more brightly lit. This gives an indication of the distance and/or the size of the metal object.

- ✔ If desired, the PCB can be built into the box type G407. A hole must then be made in the lid for the push button, the LED and the potentiometer.
- ✔ If the buzzer type SV4/12 has been requested, then this should be mounted in the place marked BUZ1. Pay careful attention to the polarity.

12. Drill pattern for optional G047 enclosure

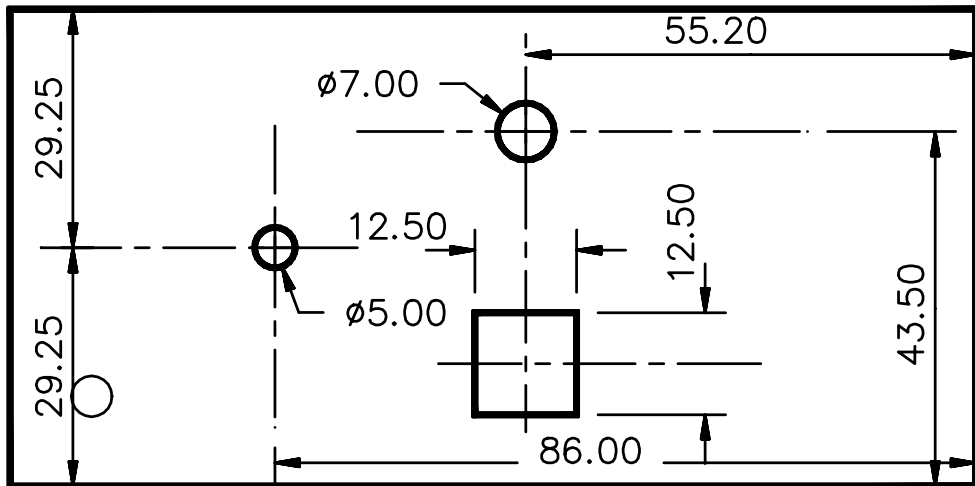

13. PCB layout.

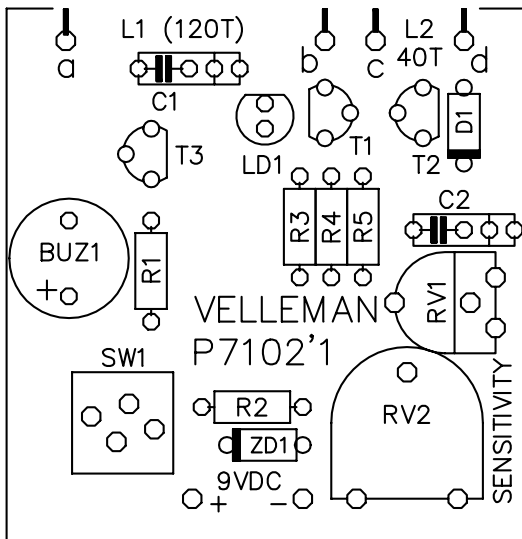

14. Diagram

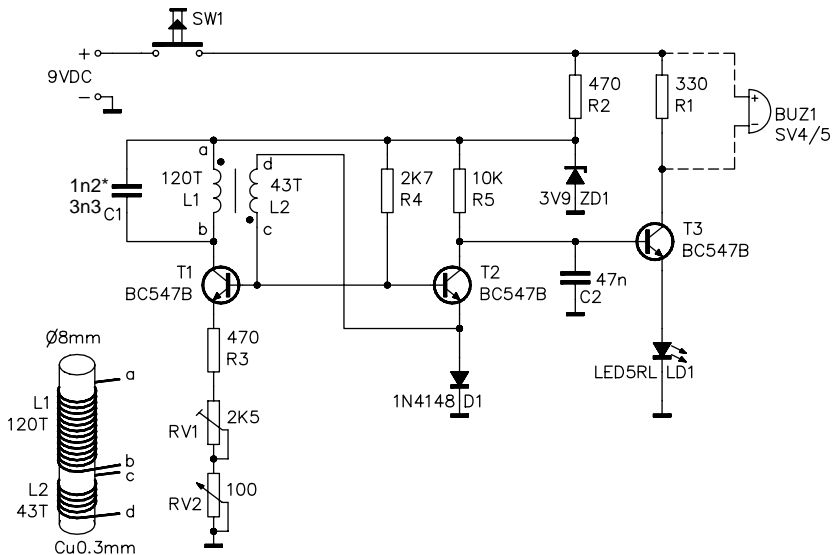



Modifications and typographical errors reserved

© Velleman Components nv.

H7102IP - 2004 - ED1 (rev.1.0)

