

# WAGO → I/O → SYSTEM 750

## Fieldbus Independent I/O Modules

### Analog Input Modules for RTD's 750-461, (/xxx-xxx)



## Manual

Version 1.1.2

Copyright © 2006 by WAGO Kontakttechnik GmbH & Co. KG  
All rights reserved.

**WAGO Kontakttechnik GmbH & Co. KG**

Hansastraße 27  
D-32423 Minden

Phone: +49 (0) 571/8 87 – 0  
Fax: +49 (0) 571/8 87 – 1 69  
E-Mail: [info@wago.com](mailto:info@wago.com)  
Web: <http://www.wago.com>

**Technical Support**

Phone: +49 (0) 571/8 87 – 5 55  
Fax: +49 (0) 571/8 87 – 85 55  
E-Mail: [support@wago.com](mailto:support@wago.com)

Every conceivable measure has been taken to ensure the correctness and completeness of this documentation. However, as errors can never be fully excluded, we would appreciate any information or ideas at any time.

E-Mail: [documentation@wago.com](mailto:documentation@wago.com)

We wish to point out that the software and hardware terms as well as the trademarks of companies used and/or mentioned in the present manual are generally trademark or patent protected.

# Content

<b>1 Important Comments .....</b>	<b>4</b>
1.1 Legal Principles .....	4
1.1.1 Copyright .....	4
1.1.2 Personnel Qualification .....	4
1.1.3 Intended Use .....	4
1.2 Symbols .....	5
1.3 Number Notation .....	5
1.4 Safety Notes .....	6
1.5 Scope .....	6
<b>2 I/O Modules .....</b>	<b>7</b>
2.1 Analog Input Modules .....	7
2.1.1 Overview Analog Input Modules for RTD's 750-461, (/xxx-xxx) .....	7
2.1.2 750-461, (/xxx-xxx) [2 AI Pt100/ RTD] .....	8
2.1.2.1 View .....	8
2.1.2.2 Variations .....	8
2.1.2.3 Description .....	9
2.1.2.4 Display Elements .....	10
2.1.2.5 Schematic Diagram .....	11
2.1.2.6 Technical Data .....	12
2.1.2.7 Process Image .....	13
2.1.2.7.1 I/O Modules for Pt Resistance Sensors .....	14
2.1.2.7.1.1 Pt 100 .....	15
2.1.2.7.1.2 Pt 1000 .....	15
2.1.2.7.1.3 Pt 100 with Status Information for S5-FB250 in Data Word... ..	16
2.1.2.7.2 I/O Modules for Ni Resistance Sensors .....	17
2.1.2.7.2.1 Ni 100 .....	17
2.1.2.7.2.2 Ni 1000 .....	18
2.1.2.7.3 I/O Modules for Resistance Measuring .....	19
2.1.2.8 Adjustable 750-461/003-000 Variation .....	20
2.1.3 750-461/020-000 [2 AI NTC 20kOhm] .....	22
2.1.3.1 View .....	22
2.1.3.2 Description .....	23
2.1.3.3 Display Elements .....	24
2.1.3.4 Schematic Diagram .....	24
2.1.3.5 Technical Data .....	25
2.1.3.6 Process Image .....	26

# 1 Important Comments

To ensure fast installation and start-up of the units described in this manual, we strongly recommend that the following information and explanations are carefully read and abided by.

## 1.1 Legal Principles

### 1.1.1 Copyright

This manual is copyrighted, together with all figures and illustrations contained therein. Any use of this manual which infringes the copyright provisions stipulated herein, is not permitted. Reproduction, translation and electronic and photo-technical archiving and amendments require the written consent of WAGO Kontakttechnik GmbH & Co. KG. Non-observance will entail the right of claims for damages.

WAGO Kontakttechnik GmbH & Co. KG reserves the right to perform modifications allowed by technical progress. In case of grant of a patent or legal protection of utility patents all rights are reserved by WAGO Kontakttechnik GmbH & Co. KG. Products of other manufacturers are always named without referring to patent rights. The existence of such rights can therefore not be ruled out.

### 1.1.2 Personnel Qualification

The use of the product detailed in this manual is exclusively geared to specialists having qualifications in PLC programming, electrical specialists or persons instructed by electrical specialists who are also familiar with the valid standards. WAGO Kontakttechnik GmbH & Co. KG declines all liability resulting from improper action and damage to WAGO products and third party products due to non-observance of the information contained in this manual.

### 1.1.3 Intended Use

For each individual application, the components supplied are to work with a dedicated hardware and software configuration. Modifications are only permitted within the framework of the possibilities documented in the manuals. All other changes to the hardware and/or software and the non-conforming use of the components entail the exclusion of liability on part of WAGO Kontakttechnik GmbH & Co. KG.

Please direct any requirements pertaining to a modified and/or new hardware or software configuration directly to WAGO Kontakttechnik GmbH & Co. KG.

## 1.2 Symbols



### **Danger**

Always abide by this information to protect persons from injury.



### **Warning**

Always abide by this information to prevent damage to the device.



### **Attention**

Marginal conditions must always be observed to ensure smooth operation.



### **ESD (Electrostatic Discharge)**

Warning of damage to the components by electrostatic discharge. Observe the precautionary measure for handling components at risk.



### **Note**

Routines or advice for efficient use of the device and software optimization.



### **More information**

References on additional literature, manuals, data sheets and INTERNET pages

## 1.3 Number Notation

Number Code	Example	Note
Decimal	100	normal notation
Hexadecimal	0x64	C notation
Binary	'100' '0110.0100'	Within ', Nibble separated with dots

## 1.4 Safety Notes



---

### Warning

Switch off the system prior to working on bus modules!

In the event of deformed contacts, the module in question is to be replaced, as its functionality can no longer be ensured on a long-term basis.

The components are not resistant against materials having seeping and insulating properties. Belonging to this group of materials is: e.g. aerosols, silicones, triglycerides (found in some hand creams).

If it cannot be ruled out that these materials appear in the component environment, then additional measures are to be taken:

- installation of the components into an appropriate enclosure
  - handling of the components only with clean tools and materials.
- 



---

### Attention

Cleaning of soiled contacts may only be done with ethyl alcohol and leather cloths. Thereby, the ESD information is to be regarded.

Do not use any contact spray. The spray may impair the functioning of the contact area.

The WAGO-I/O-SYSTEM 750 and its components are an open system. It must only be assembled in housings, cabinets or in electrical operation rooms. Access must only be given via a key or tool to authorized qualified personnel.

The relevant valid and applicable standards and guidelines concerning the installation of switch boxes are to be observed.

---



---

### ESD (Electrostatic Discharge)

The modules are equipped with electronic components that may be destroyed by electrostatic discharge. When handling the modules, ensure that the environment (persons, workplace and packing) is well grounded. Avoid touching conductive components, e.g. gold contacts.

---

## 1.5 Scope

This manual describes the Analog Input Modules 750-461, (/xxx-xxx)  
Analog Input Modules for RTD's of the modular WAGO-I/O-SYSTEM 750.

Handling, assembly and start-up are described in the manual of the Fieldbus Coupler. Therefore this documentation is valid only in the connection with the appropriate manual.

## 2 I/O Modules

### 2.1 Analog Input Modules

#### 2.1.1 Overview Analog Input Modules for RTD's 750-461, (/xxx-xxx)

I/O Module	<a href="#">750-461</a>	<a href="#">750-461/ 000-002</a>	<a href="#">750-461/ 000-003</a>	<a href="#">750-461/ 000-004</a>	<a href="#">750-461/ 000-005</a>
Function	PT100/ RTD	Resistance Measuring 10R-1k2	PT1000/ RTD	Ni 100/ RTD	Ni 1000/ RTD
Channels	2	2	2	2	2
Measuring range	-200 °C ... +850 °C	10 Ω ... 1,2 kΩ	-200 °C ... +850 °C	-60 °C ... +250 °C	-60 °C ... +250 °C
Counter depth	2 x 16 bits Data 2 x 8 bits Control/ Status (option)	2 x 16 bits Data 2 x 8 bits Control/ Status (option)	2 x 16 bits Data 2 x 8 bits Control/ Status (option)	2 x 16 bits Data 2 x 8 bits Control/ Status (option)	2 x 16 bits Data 2 x 8 bits Control/ Status (option)

I/O Module	<a href="#">750-461/ 000-006</a>	<a href="#">750-461/ 000-007</a>	<a href="#">750-461/ 000-200</a>	<a href="#">750-461/ 003-000</a>	<a href="#">750-461/ 020-000</a>
Function	PT100/ RTD/ high precision	Resistance Measuring 10R-5k0	PT100/ RTD/ with status informatio ns	PT100/ RTD/ adjustable	NTC 20kOhm
Channels	2	2	2	2	2
Measuring range	-200 °C ... +850 °C	10 Ω ... 5,0 kΩ	-200 °C ... +850 °C,	-200 °C ... +850 °C	-30 °C ... +130 °C
Counter depth	2 x 16 bits Data 2 x 8 bits Control/ Status (option)	2 x 16 bits Data 2 x 8 bits Control/ Status (option)	2 x 16 bits Data 2 x 8 bits Control/ Status (option)	2 x 16 bits Data 2 x 8 bits Control/ Status (option)	2 x 16 bits Data 2 x 8 bits Control/ Status (option)

## 2.1.2 750-461, (/xxx-xxx) [2 AI Pt100/ RTD]

2-Channel Analog Input Module for RTDs  
2- or 3-wire connection

### 2.1.2.1 View

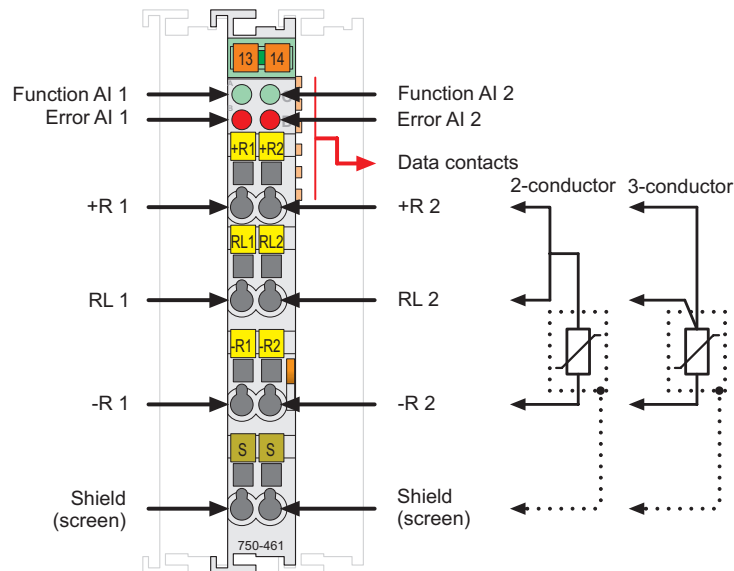

Fig. 2.1.2-1: 2-Channel Analog Input Module 750-461

g046100e

### 2.1.2.2 Variations

Item-No.	Designation	Description
<b>Pt resistance sensors</b>		
750-461	2 AI PT100/RTD	2-Channel Analog Input Module, Pt 100 Measuring range: -200 °C ... +850 °C
750-461/000-003	2 AI PT1000/RTD	2-Channel Analog Input Module, Pt 1000 Measuring range: -200 °C ... +850 °C
750-461/000-006	2 AI PT100/RTD/ high precision	2-Channel Analog Input Module, Pt 100 Measuring range: -200 °C ... +850 °C
750-461/000-200	2 AI PT100/RTD/ With status information	2-Channel Analog Input Module, Pt 100 Measuring range: -200 °C ... +850 °C, With status information for S5-FB250
<b>Ni resistance sensors</b>		
750-461/000-004	2 AI Ni 100/RTD	2-Channel Analog Input Module, Ni 100 Measuring range: -60 °C ... +250 °C
750-461/000-005	2 AI Ni 1000/RTD	2-Channel Analog Input Module, Ni 1000 Measuring range: -60 °C ... +250 °C



Item-No.	Designation	Description
<b>Resistance measuring</b>		
750-461/000-002	2 AI Resistance Measuring, 10R-1k2	2-Channel Analog Input Module, Resistance measuring, Measuring range: 10 Ω ... 1,2 kΩ
750-461/000-007	2 AI Resistance Measuring, 10R-5k0	2-Channel Analog Input Module, Resistance measuring, Measuring range: 10 Ω ... 5,0 kΩ
<b>Operating mode configurable with WAGO-I/O-CHECK</b>		
750-461/003-000	2 AI PT100/RTD/ Adjustable	2-Channel Analog Input Module, Adjustable; Factory preset: Pt 100 Measuring range: -200 °C ... +850 °C

### 2.1.2.3 Description

The 750-461 analog input module and its 750-461/xxx-xxx variations allow Pt or Ni Resistive Temperature Devices, RTDs, to be measured in the field. It can also be used to measure resistances in the field.

Depending on the operating mode, the resistance value is converted to a temperature or directly sent out by the module. A microprocessor within the module is used for converting and linearizing the measured resistance value into a numeric value proportional to the temperature of the selected resistance sensor.

The operating mode of the 750-461/003-000 variation can be set by using the **WAGO-I/O-CHECK 2** start-up and diagnostic tool (Item No.: 759-302). The default setting is Pt 100. After setting the parameters, the module behaves like the version with the selected operating mode.

The operating mode of the 750-461 basic module described in this manual is for a Pt 100 resistance sensor.

The analog input module is a 2- to 3-conductor device and has 2 input channels. Two devices may be directly connected to the module.

For example, two 3-wire sensors can be connected either to +R1, RL1 and – R1 or to +R2, RL2 and –R2.

For the connection of 2-wire sensors, putting of a bridge is necessary between +R1 and RL1 or +R2 and RL2.

The shield (screen) is directly connected to the DIN rail. A capacitive connection is made automatically when snapped onto the DIN rail.

An optocoupler is used for electrical isolation between the bus and the field side.

The operational readiness and trouble-free internal data bus communication of the channels are indicated via a green function LED. A broken wire, short-circuit or overrange are indicated by a red error LED per channel.

After the error has been corrected, the module needs up to 4 seconds to output a correct measured value, the module 750-461/000-006 needs up to 12 seconds.

Any configuration of the input modules is possible when designing the fieldbus node. Grouping of module types is not necessary.



**Attention**

This module has no power contacts. For field supply to downstream I/O modules, a supply module will be needed.

The analog input module 750-461 and its variations can be used with all couplers/controllers of the WAGO-I/O-SYSTEM 750 (except for the economy types 750-320, -323, -324 and -327).

**2.1.2.4 Display Elements**

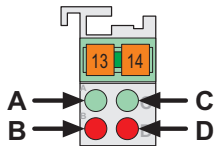

Fig. 2.1.2-2:  
 Display Elements  
 g045202x

LED	Channel	State	Function	
A green	1	off	No operational readiness or the internal data bus communication is interrupted	
		on	Operational readiness and trouble-free internal data bus communication	
off		Normal operation		
B red		on	750-461, 750-461/000-003, -004, -005, -006	Overrange/underflow of the admissible measuring range, broken wire
			750-461/000-200	Overrange of the admissible measuring range, broken wire
			750-461/000-002	Overrange/underflow of the admissible measuring range
			750-461/000-007	Overrange of the admissible measuring range
C green		2	off	No operational readiness or the internal data bus communication is interrupted
	on		Operational readiness and trouble-free internal data bus communication	
off	Normal operation			
D red	on		750-461, 750-461/000-003, -004, -005, -006	Overrange/underflow of the admissible measuring range, broken wire
			750-461/000-200	Overrange of the admissible measuring range, broken wire
			750-461/000-002	Overrange/underflow of the admissible measuring range
			750-461/000-007	Overrange of the admissible measuring range

2.1.2.5 Schematic Diagram

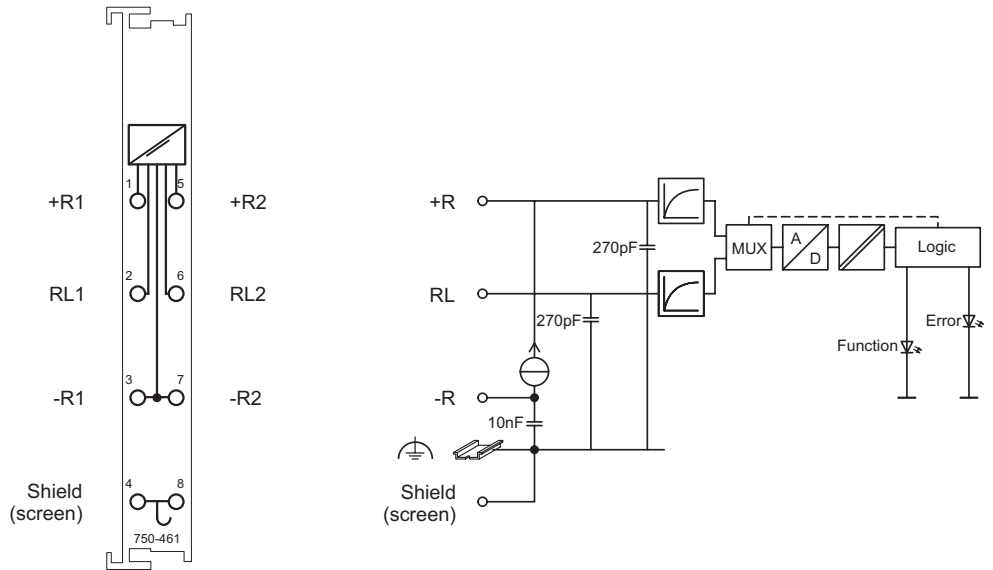













Fig. 2.1.2-3: 2-Channel Analog Input Module 750-461

g046101e

### 2.1.2.6 Technical Data

<b>Module Specific Data</b>	
Number of inputs	2
Voltage supply	via system voltage DC /DC
Current consumption <sub>max.</sub> (internal)	80 mA
Sensor types (the free configurable variation supports all listed sensor types)	Pt 100 (factory preset), optionally orderable variants for Pt 200, Pt 500, Pt 1000, Ni 100, Ni 120, Ni 1000, resistance measuring.
Sensor connection	3-wire (factory preset) or 2-wire
Temperature range	-200 °C ... +850 °C (Pt) -60 °C ... +250 °C (Ni)
Resolution	0,1 °C
Conversion time	320 ms (per channel) 960 ms (per channel for 750-461/000-006)
Response delay <sub>max.</sub> (time from starting or connecting the sensor to the first proper measured value)	4 s 12 s (for 750-461/000-006)
Measuring error <sub>25°C</sub>	<± 0.2 % of full scale value
Temperature coefficient	<± 0.01 % /K of full scale value <± 0,001 % /K of full scale value (for 750-460/000-006)
Isolation	500 V (System/Supply)
Measured current <sub>typ.</sub>	0.5 mA
Bit width	2 x 16 bits data 2 x 8 bits control/status (option)
Dimensions (mm) W x H x L	12 x 64* x 100 * from upper edge of 35 DIN rail
Weight	ca. 55 g
<b>Standards and Regulations (cf. Chapter 2.2 of the Coupler/Controller Manual)</b>	
EMC-Immunity to interference (CE)	acc. to EN 50082-2 (96)
EMC-Emission of interference (CE)	acc. to EN 50081-1 (93)
EMC-Immunity to interference (Ship building)	acc. to Germanischer Lloyd (01)
EMC-Emission of interference (Ship building)	acc. to Germanischer Lloyd (01)

Approvals (cf. Chapter 2.2 of the Coupler/Controller Manual)		
	cUL <sub>US</sub> (UL508)	
	ABS (American Bureau of Shipping)	
	BV (Bureau Veritas)	
	DNV (Det Norske Veritas)	Cl. B
	GL (Germanischer Lloyd)	Cat. A, B, C, D
	KR (Korean Register of Shipping)	
	LR (Lloyd's Register)	Env. 1, 2, 3, 4
	NKK (Nippon Kaiji Kyokai)	
	RINA (Registro Italiano Navale)	
	cUL <sub>US</sub> (UL1604)	Class I Div2 ABCD T4A
	KEMA	II 3 G EEx nA II T4
	Conformity Marking	



#### More Information

Detailed references to the approvals are listed in the document "Overview Approvals WAGO-I/O-SYSTEM 750", which you can find on the CD ROM ELECTRONICC Tools and Docs (Item-No.: 0888-0412)

or in the internet under:

[www.wago.com](http://www.wago.com) → Documentation → WAGO-I/O-SYSTEM 750 → System Description

#### 2.1.2.7 Process Image

Some fieldbus systems can process input channel status information by means of a status byte.

This status byte can be displayed via the WAGO-I/O-CHECK 2 start-up and diagnostic tool. However, processing via the coupler / controller is optional, which means that accessing or parsing the status information depends on the fieldbus system.



**Attention**

The representation of the process data of some I/O modules or their variations in the process image depends on the fieldbus coupler/-controller used. Please take this information as well as the particular design of the respective control/status bytes from the section "Fieldbus Specific Design of the Process Data" included in the description concerning the process image of the corresponding coupler/controller.

---

**2.1.2.7.1 I/O Modules for Pt Resistance Sensors**

Pt resistance sensors (Measuring range: -200 °C ... +850 °C)	
750-461	Evaluation of Pt 100
750-461/000-003	Evaluation of Pt 1000
750-461/000-006	Evaluation of Pt 100, high precision (0.001%/K) (Conversion time 960ms)
750-461/000-200	Evaluation of Pt 100, with status information for S5-FB250

To evaluate the platinum resistance sensors (750-461, 750-461/000-003 and 750-461/000-006) the measured values of the resistance are converted and sent as temperature values.

All temperature values are represented in a standard numeric format. The possible numerical range matches the defined temperature range of the Pt sensors from -200 °C to +850 °C.

In the Pt 100 or Pt 1000 setting, the temperature values of the sensors are represented with a resolution of 1 digit per 0.1 °C within a word (16 bits). Thus, 0 °C corresponds to the numeric value 0x0000 and 100 °C to 0x03E8 (dec. 1000).

Temperature values below 0 °C are represented in two's complement binary form.

The measured values of the resistance are directly sent by the 750-461/000-200 (Pt 100) module.

### 2.1.2.7.1.1 Pt 100

The analog input modules 750-461 and 750-461/000-006 transmit 16-bit measured values per channel as well as 8 optional status bits to the coupler/controller.

However, accessing the status byte depends on the fieldbus system being used.

750-461, /000-006 (Pt 100)						
Tem- perature °C	Resis- tance Ω	Numerical value <sup>1)</sup>			Status- byte Hex.	LED Error AI 1, 2
		binary	hex.	dec.		
<-200.0	10.00	'1000.0000.0000.0001'	0x8001	-32767	0x41	on
-200.0	18.49	'1111.1000.0011.0000'	0xF830	-2000	0x00	off
-100.0	60.25	'1111.1100.0001.1000'	0xFC18	-1000	0x00	off
0.0	100.00	'0000.0000.0000.0000'	0x0000	0	0x00	off
100.0	138.50	'0000.0011.1110.1000'	0x03E8	1000	0x00	off
200.0	175.84	'0000.0111.1101.0000'	0x07D0	2000	0x00	off
500.0	280.90	'0001.0011.1000.1000'	0x1388	5000	0x00	off
750.0	360.47	'0001.1101.0100.1100'	0x1D4C	7500	0x00	off
800.0	375.51	'0001.1111.0100.0000'	0x1F40	8000	0x00	off
850.0	390.26	'0010.0001.0011.0100'	0x2134	8500	0x00	off
>850.0	>390.26	'0010.0001.0011.0100'	0x2134	8500	0x42	on
Broken wire against R <sub>L</sub>		'0010.0001.0011.0100'	0x2134	8500	0x42	on

<sup>1)</sup> Temperature values below 0 °C are represented in two's complement binary form.

The measured value can exceed the range from decimal –2000 to 8500 until the limitation applies.

### 2.1.2.7.1.2 Pt 1000

The analog input modules 750-461/000-003 transmit 16-bit measured values per channel as well as 8 optional status bits to the coupler/controller.

However, accessing the status byte depends on the fieldbus system being used.

750-461/000-003 (Pt 1000)						
Tem- perature °C	Resis- tance Ω	Numerical value <sup>1)</sup>			Status- byte Hex.	LED Error AI 1, 2
		binary	hex.	dec.		
<-200.0	100.00	'1000.0000.0000.0001'	0x8001	-32767	0x41	on
-200.0	184.93	'1111.1000.0011.0000'	0xF830	-2000	0x00	off
-100.0	602.54	'1111.1100.0001.1000'	0xFC18	-1000	0x00	off
0.0	1000.00	'0000.0000.0000.0000'	0x0000	0	0x00	off
100.0	1385.00	'0000.0011.1110.1000'	0x03E8	1000	0x00	off
200.0	1758.40	'0000.0111.1101.0000'	0x07D0	2000	0x00	off
500.0	2808.96	'0001.0011.1000.1000'	0x1388	5000	0x00	off
750.0	3604.65	'0001.1101.0100.1100'	0x1D4C	7500	0x00	off
800.0	3755.09	'0001.1111.0100.0000'	0x1F40	8000	0x00	off
850.0	3902.62	'0010.0001.0011.0100'	0x2134	8500	0x00	off
>850.0	>3902.62	'0010.0001.0011.0100'	0x2134	8500	0x42	on
Broken wire against R <sub>L</sub>		'0010.0001.0011.0100'	0x2134	8500	0x42	on

<sup>1)</sup> Temperature values below 0 °C are represented in two's complement binary form.

The measured value can exceed the range from decimal –2000 to 8500 until the limitation applies.

**2.1.2.7.1.3Pt 100 with Status Information for S5-FB250 in Data Word**

The analog input module 750-461/000-200 transmits 16-bit measured values per channel as well as 8 optional status bits to the coupler/controller.

When a S5 is used as higher-level control system, this data can be directly processed using the FB 250 function block.

However, accessing the status byte depends on the fieldbus system being used.

The status information is mapped to bits 0 to 2 and the digitized measured value to bits 3 to 14.

750-461/000-200							
Tem- perature °C	Resis- tance Ω	Numerical value <sup>2)</sup> with status information <sup>1)</sup>				Status- byte hex.	LED Error AI 1,2
		binary	XFÜ <sub>1)</sub>	hex.	dec.		
	10	'0000.0011.0011.0	000'	0x0330	819	0x00	off
-200.0	20	'0000.0110.0110.0	000'	0x0660	1638	0x00	off
-185.0	25	'0000.1000.0000.0	000'	0x0800	2048	0x00	off
-125.0	50	'0001.0000.0000.0	000'	0x1000	4096	0x00	off
0.0	100	'0010.0000.0000.0	000'	0x2000	8192	0x00	off
266.0	200	'0100.0000.0000.0	000'	0x4000	16384	0x00	off
560.0	300	'0110.0000.0000.0	000'	0x6000	24576	0x00	off
850.0	390	'0111.1100.1100.1	000'	0x7CC8	32949	0x00	off
	800	'1111.1111.1111.1	000'	0xFFF8	65535	0x00	off
	>800	undefined				0x00	off
	>ca.1200	'0001.0000.0001.0	001'	0x1011	4113	0x42	on

<sup>1)</sup> Status information: X: not used, F: short-circuit, broken wire, Ü: overrange

<sup>2)</sup> Temperature values below 0 °C are represented in two's complement binary form.

Values marked with "ca." are not calibrated.



### 2.1.2.7.2 I/O Modules for Ni Resistance Sensors

Ni resistance sensors (Measuring range: -60 °C ... +250 °C)	
750-461/000-004	Evaluation of Ni 100
750-461/000-005	Evaluation of Ni 1000

To evaluate the nickel resistance sensors, the measured values of the resistance are converted and sent as temperature values.

All temperature values are represented in a standard numeric format. The possible numerical range matches the defined temperature range of the Ni sensors from -60 °C to +250 °C.

#### 2.1.2.7.2.1 Ni 100

In the Ni 100 setting 750-461/000-004, the temperature values of the sensors are represented with a resolution of 1 digit per 0.1 °C within a word (16 bits). Thus, 0 °C corresponds to the numeric value 0x0000 and 100 °C to 0x03E8 (dec. 1000).

Temperature values below 0 °C are represented in two's complement binary form.

The analog input modules transmits 16-bit measured values per channel as well as 8 optional status bits to the coupler/controller.

750-461/000-004 (Ni 100)						
Temperature °C	Resistance Ω	Numerical value <sup>1)</sup>			Status- byte hex.	LED Error AI 1,2
		binary	hex.	dec.		
<-60.0	< 69.16	'1000.0000.0000.0001'	0x8001	-32767	0x41	on
-60.0	69.16	'1111.1101.1010.1000'	0xFDA8	-600	0x00	off
-50.0	74.26	'1111.1110.0000.1100'	0xFE0C	-500	0x00	off
0.0	100.00	'0000.0000.0000.0000'	0x0000	0	0x00	off
50.0	129.10	'0000.0001.1111.0100'	0x01F4	500	0x00	off
100.0	161.77	'0000.0011.1110.1000'	0x03E8	1000	0x00	off
150.0	198.62	'0000.0101.1101.1100'	0x05DC	1500	0x00	off
200.0	240.64	'0000.0111.1101.0000'	0x07D0	2000	0x00	off
250.0	289.13	'0000.1001.1100.0100'	0x09C4	2500	0x00	off
>250.0	>289.13	'0010.0001.0011.0100'	0x2134	8500	0x42	on
Broken wire against R <sub>L</sub>		'0010.0001.0011.0100'	0x2134	8500	0x42	on

<sup>1)</sup> Temperature values below 0 °C are represented in two's complement binary form.

The measured value can exceed the range from decimal -600 to 2500 until the limitation applies.

### 2.1.2.7.2.2 Ni 1000

In the Ni 1000 setting 750-461/000-005, the temperature values of the sensors are represented with a resolution of 1 digit per 0.1 °C within a word (16 bits). Thus, 0 °C corresponds to the numeric value 0x0000 and 100 °C to 0x03E8 (dec. 1000).

Temperature values below 0 °C are represented in two's complement binary form.

The analog input modules transmits 16-bit measured values per channel as well as 8 optional status bits to the coupler/controller.

750-461/000-005 (Ni 1000)						
Temperature °C	Resistance Ω	Numerical value <sup>1)</sup>			Status- byte hex.	LED Error AI 1,2
		binary	hex.	dec.		
<-60.0	< 691.60	'1000.0000.0000.0001'	0x8001	-32767	0x41	on
-60.0	691.60	'1111.1101.1010.1000'	0xFDA8	-600	0x00	off
-50.0	742.60	'1111.1110.0000.1100'	0xFE0C	-500	0x00	off
0.0	1000.00	'0000.0000.0000.0000'	0x0000	0	0x00	off
50.0	1291.00	'0000.0001.1111.0100'	0x01F4	500	0x00	off
100.0	1617.96	'0000.0011.1110.1000'	0x03E8	1000	0x00	off
150.0	1986.20	'0000.0101.1101.1100'	0x05DC	1500	0x00	off
200.0	2406.40	'0000.0111.1101.0000'	0x07D0	2000	0x00	off
250.0	2891.31	'0000.1001.1100.0100'	0x09C4	2500	0x00	off
>250.0	>2891.31	'0010.0001.0011.0100'	0x2134	8500	0x42	on
Broken wire against R <sub>L</sub>		'0010.0001.0011.0100'	0x2134	8500	0x42	on

<sup>1)</sup> Temperature values below 0 °C are represented in two's complement binary form.

The measured value can exceed the range from decimal -600 to 2500 until the limitation applies.

### 2.1.2.7.3 I/O Modules for Resistance Measuring

Resistance measuring	
750-461/000-002	Resistance measuring, Measuring range: 10 Ω ... 1.2 kΩ
750-461/000-007	Resistance measuring, Measuring range: 10 Ω ... 5.0 kΩ

The measured values are sent out directly when measuring the resistance. Using the 750-461/000-002 module with measuring range from 10 Ω to 1.2 kΩ, the resolution is 1 digit per 0.1 Ω.

Using the 750-461/000-007 module with measuring range from 10 Ω to 5.0 kΩ, the resolution is 1 digit per 0.5 Ω.

Resistance measurement is only possible in 2-wire connection technology.

The analog input module transmits 16-bit measured values per channel as well as 8 optional status bits to the coupler/controller.

750-461/000-002 (10 Ω ... 1,2 kΩ)					
Resistance Ω	Numerical value			Status- byte hex.	LED Error AI 1,2
	binary	hex.	dec.		
0	'1110.1100.0000.0000'	0xEC00	-5120	0x00	off
10	'0000.0000.0110.0100'	0x0064	100	0x00	off
100	'0000.0011.1110.1000'	0x03E8	1000	0x00	off
200	'0000.0111.1101.0000'	0x07D0	2000	0x00	off
300	'0000.1011.1011.1000'	0x0BB8	3000	0x00	off
400	'0000.1111.1010.0000'	0x0FA0	4000	0x00	off
500	'0001.0011.1000.1000'	0x1388	5000	0x00	off
750	'0001.1101.0100.1100'	0x1D4C	7500	0x00	off
1000	'0010.0111.0001.0000'	0x2710	10000	0x00	off
1200	'0010.1110.1110.0000'	0x2EE0	12000	0x00	off
>ca.1200	'0010.0001.0011.0100'	0x2134	8500	0x42	on

Values marked with "ca." are not calibrated.

750-461/000-007 (10 Ω ... 5 kΩ)					
Resistance Ω	Numerical value			Status- byte hex.	LED Error AI 1,2
	binary <sup>1)</sup>	hex.	dec.		
0	'1110.1100.0000.0000'	0xEC00	-5120	0x00	off
10	'0000.0000.0001.0100'	0x0014	20	0x00	off
100	'0000.0000.1100.1000'	0x00C8	200	0x00	off
200	'0000.0001.1001.0000'	0x0190	400	0x00	off
300	'0000.0010.0101.1000'	0x0258	600	0x00	off
1000	'0000.0111.1101.0000'	0x07D0	2000	0x00	off
2000	'0000.1111.1010.0000'	0x0FA0	4000	0x00	off
3000	'0001.0111.0111.0000'	0x1770	6000	0x00	off
4000	'0001.1111.0100.0000'	0x1F40	8000	0x00	off
5000	'0010.0111.0001.0000'	0x2710	10000	0x00	off
>ca.5000	'0010.0111.0001.0000'	0x2710	10000	0x42	on

Values marked with "ca." are not calibrated.

### 2.1.2.8 Adjustable 750-461/003-000 Variation

The operating mode of the 750-461/003-000 variation can be parameterized using the **WAGO-I/O-CHECK 2** start-up and diagnostic tool (Item No.: 759-302).

The default setting is Pt 100. In this operating mode, the module has the same behavior and process values as the 750-461 basic module.

The parameter dialog box of **WAGO-I/O-CHECK 2** contains select boxes that are used to set this module.

Select box	Available settings	
RTD Type	Pt100 (-200 °C – 850 °C)* / Ni100 (-60 °C – 250 °C) / Pt1000 (-200 °C – 850 °C) / Pt500 (-200 °C – 850 °C) / Pt200 (-200 °C – 850 °C) / Ni1000 (-80 °C – 320 °C) / Ni120 (-80 °C – 320 °C) / Ohm ( 10.0 Ω – 5000.0 Ω) / Ohm (10.0 Ω – 1200.0 Ω)	
Connection	2-wire	Two-wire connection
	3-wire*	Three-wire connection
State-Bits	OFF*	State bits are not mapped
	ON	State bits are mapped to the lower three bits of the output value:  Bit 0:overrun. Bit is set if measuring value runs out of range.  Bit 1:error. Bit is set if the module detects an error in internal functions or a shortcut at the input.  Bit 2: 0
Watchdog Timer	OFF	Watchdog timer not active
	ON*	Watchdog timer active. If no data are exchanged with the buscoupler for 100 ms, the green LEDs will turn off.
Amount Sign	OFF*	Two's complement indication
	ON	Amount/Sign indication
Filter Constants	12.5 Hz – 500 ms / 25 Hz – 250 ms* / 50 Hz – 125 ms / 60 Hz – 110 ms / 100 Hz – 65 ms	
Overrange Protection	OFF	The output value is not limited
	ON*	If the temperature exceeds 850°C, the status bits are set and the output value is limited to 850°C
User Scaling	OFF*	User scaling not active
	ON	User scaling active
WAGO Scaling	OFF	WAGO scaling not active
	ON*	WAGO scaling active

\* default settings

In **WAGO-I/O-CHECK 2**, the following input boxes allow you to set the offset and gain values of the user and manufacturer scaling.

Input box	...	Offset	Gain
User Scaling	...	0x0000	0x0100
WAGO Scaling	...	0x0000	0x00A0

The following input boxes are available in **WAGO-I/O-CHECK 2** for hardware calibration.

Input box	Settings
Offset	0xECF0
Gain	0x2700
2-wire-offset	0x0180



---

#### **Further information**

You can find detailed information on parameterizing this module in the **WAGO-I/O-CHECK 2** manual or on the Internet at [www.wago.com](http://www.wago.com).

---

### 2.1.3 750-461/020-000 [2 AI NTC 20kOhm]

2 Channel Analog Input Module for NTC 20kOhm RTDs,  
2-wire connection

#### 2.1.3.1 View

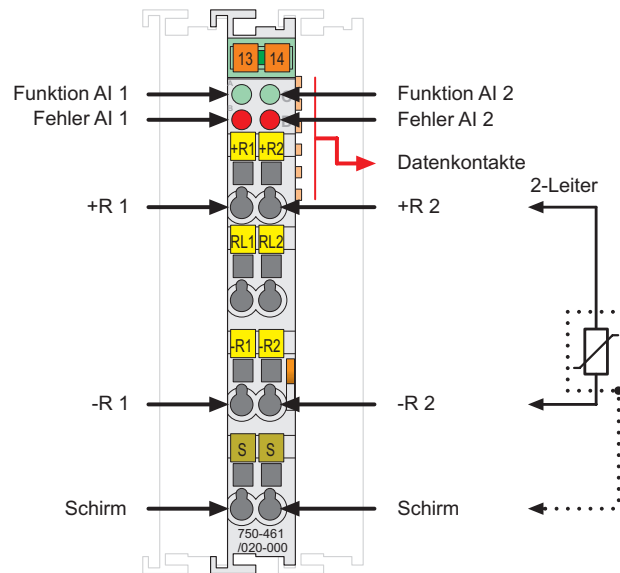

Fig. 2.1.3-1: 2-2-Channel Analog Input Module 750-461/020-000

g046103e

### 2.1.3.2 Description

The analog input module 750-461/020-000 evaluates NTC 20kOhm resistance Temperature Devices, RTDs.

The resistance value is converted to a temperature. A microprocessor within the module is used for converting and linearizing the measured resistance value into a numeric value proportional to the temperature of the selected resistance sensor.

The analog input module is a 2-conductor device and has 2 input channels. Two devices may be directly connected to the module. The shield (screen) is directly connected to the DIN rail. A capacitive connection is made automatically when snapped onto the DIN rail.

An optocoupler is used for electrical isolation between the bus and the field side.

The operational readiness and trouble-free internal data bus communication of the channels are indicated via a green function LED. A broken wire, short-circuit or overrange are indicated by a red error LED per channel. After the error has been corrected, the module needs up to 4 seconds to output a correct measured value.

Any configuration of the input modules is possible when designing the fieldbus node. Grouping of module types is not necessary.



---

#### **Attention**

This module has no power contacts. For field supply to downstream I/O modules, a supply module will be needed.

---

The analog input module can be used with all couplers/controllers of the WAGO-I/O-SYSTEM 750 (except for the economy types 750-320, -323, -324 and -327).

### 2.1.3.3 Display Elements

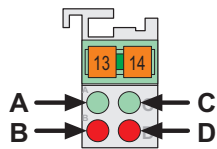

Fig. 2.1.3-2:  
 Display elements  
 g045202x

LED	Chan nel	State	Function
A gree n	1	off	No operational readiness or the internal data bus communication is interrupted
		on	Operational readiness and trouble-free internal data bus communication
off		Normal operation	
on		Overrange/underflow of the admissible measuring range, broken wire	
B red	2	off	No operational readiness or the internal data bus communication is interrupted
		on	Operational readiness and trouble-free internal data bus communication
off		Normal operation	
on		Overrange/underflow of the admissible measuring range, broken wire	
C gree n	1	off	No operational readiness or the internal data bus communication is interrupted
		on	Operational readiness and trouble-free internal data bus communication
off		Normal operation	
on		Overrange/underflow of the admissible measuring range, broken wire	
D red	2	off	No operational readiness or the internal data bus communication is interrupted
		on	Operational readiness and trouble-free internal data bus communication
off		Normal operation	
on		Overrange/underflow of the admissible measuring range, broken wire	

### 2.1.3.4 Schematic Diagram

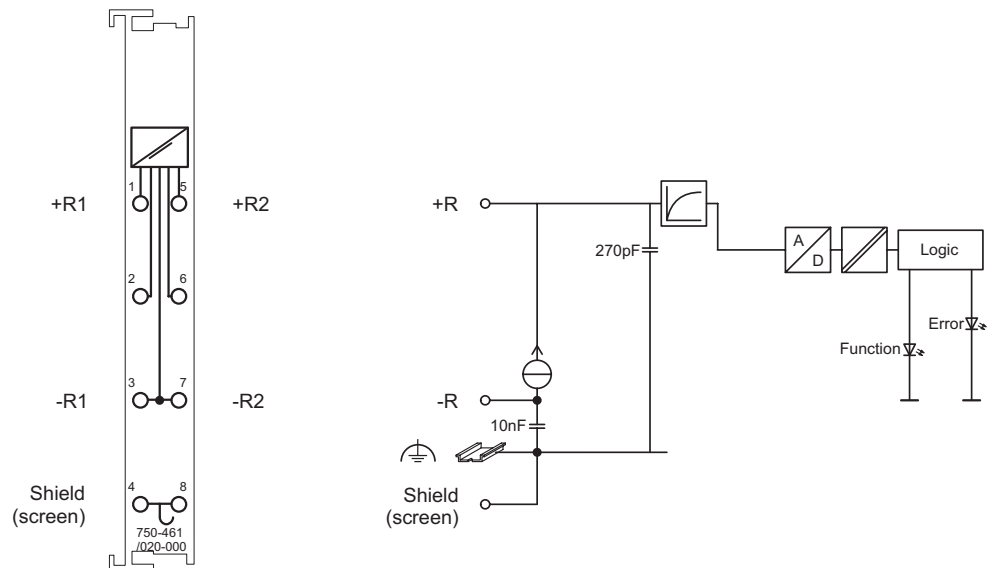



Fig. 2.1.3-3: 2-Channel Analog Input Module 750-461/020-000

g046104e



## 2.1.3.5 Technical Data

Module Specific Data	
Number of inputs	2
Voltage supply	via system voltage DC /DC
Current consumption <sub>max.</sub> (internal)	65 mA
Sensor types	NTC 20kOhm
Sensor connection	2-wire
Temperature range	-30 °C ... +130 °C
Resolution	0,1 °C
Conversion time	320 ms (per channel)
Response delay <sub>max.</sub> (time from starting or connecting the sensor to the first proper measured value)	4 s
Measuring error (The specified accurancys apply to a supply line resistance of $R_L < 1 \text{ Ohm}$ )	$< \pm 1,0 \text{ K}$ in the range of $-30 \text{ °C} \dots +50 \text{ °C}$ ( $< \pm 0,5 \text{ K}$ at $25 \text{ °C}$ ) $< \pm 2,0 \text{ K}$ in the range of $+50 \text{ °C} \dots +100 \text{ °C}$ $< \pm 3,0 \text{ K}$ in the range of $+100 \text{ °C} \dots +130 \text{ °C}$
Temperature coefficient	$< \pm 0,002 \text{ \% /K}$ of full scale value
Isolation	400 V (system/supply)
Measured current <sub>typ.</sub>	0,05 mA at $25 \text{ °C}$
Bit width	2 x 16 bits data 2 x 8 bits Control/Status (option)
Dimensions (mm) W x H x L	12 x 64* x 100 * from upper edge of 35 DIN rail
Weight	ca. 55 g
Standards and Regulations (cf. Chapter 2.2 of the Coupler/Controller Manual)	
EMC-Immunity to interference (CE)	acc. to EN 61000-6-2 (01)
EMC-Emission of interference (CE)	acc. to EN 61000-6-3 (01)
Approvals (cf. Chapter 2.2 of the Coupler/Controller Manual)	
	cUL <sub>US</sub> (UL508)
	Conformity Marking

**More Information**

Detailed references to the approvals are listed in the document "Overview Approvals WAGO-I/O-SYSTEM 750", which You can find on the CD ROM ELECTRONICC Tools and Docs (Item-No.: 0888-0412-0001-0101) or in the Internet under:

[www.wago.com](http://www.wago.com) -> Service /Downloads /Documentation /WAGO-I/O-SYSTEM 750/System Description/.

### 2.1.3.6 Process Image

Some fieldbus systems can process input channel status information by means of a status byte.

This status byte can be displayed via the WAGO-I/O-CHECK 2 start-up and diagnostic tool. However, processing via the coupler / controller is optional, which means that accessing or parsing the status information depends on the fieldbus system.



#### Attention

The representation of the process data of some I/O modules or their variations in the process image depends on the fieldbus coupler/-controller used. Please take this information as well as the particular design of the respective control/status bytes from the section "Fieldbus Specific Design of the Process Data" included in the description concerning the process image of the corresponding coupler/controller.

The analog input modules 750-461/020-000 transmit 16-bit measured values per channel as well as 8 optional status bits to the coupler/controller.

To evaluate the NTC 20kOhm resistance sensors the measured values of the resistance are converted and sent as temperature values.

All temperature values are represented in a standard numeric format. The possible numerical range matches the defined temperature range of the sensors from -30 °C to +130 °C.

In the NTC 20kOhm setting, the temperature values of the sensors are represented with a resolution of 1 digit per 0.1 °C within a word (16 bits). Thus, 0 °C corresponds to the numeric value 0x0000 and 100 °C to 0x03E8 (dec. 1000).

Temperature values below 0 °C are represented in two's complement binary form.

750-461/020-000						
Tem- perature °C	Resis- tance kΩ	Numerical value <sup>1)</sup>			Status- byte Hex.	LED Error AI 1, 2
		binary	hex.	dec.		
<ca -30.0	>414.70	'0010.0001.0011.0100'	0x2134	8500	0x42	on
-30.0	414.70	'1111.1110.1101.0100'	0xFED4	-300	0x00	off
0.0	70.20	'0000.0000.0000.0000'	0x0000	0	0x00	off
25.0	20.00	'0000.0000.1111.1010'	0x00FA	250	0x00	off
50.0	6.72	'0000.0001.1111.0100'	0x01F4	500	0x00	off
100.0	1.12	'0000.0011.1110.1000'	0x03E8	1000	0x00	off
130.0	0.46	'0000.0101.0001.0100'	0x0514	1300	0x00	off
>ca 130.0	< 0.46	'1000.0000.0000.0001'	0x8001	-32767	0x41	on

<sup>1)</sup> Temperature values below 0 °C are represented in two's complement binary form.

The measured value can exceed the range from decimal -300 to 1300 until the limitation applies.





WAGO Kontakttechnik GmbH & Co. KG  
Postfach 2880 • D-32385 Minden  
Hansastraße 27 • D-32423 Minden  
Phone: 05 71/8 87 – 0  
Fax: 05 71/8 87 – 1 69  
E-Mail: [info@wago.com](mailto:info@wago.com)

Internet: <http://www.wago.com>

---