

WAGO → I/O → SYSTEM 750

**Fieldbus Independent
I/O Modules**

**4 AI DC ± 10 V, Single-Ended
750-457**



Manual

Version 1.0.2

Copyright © 2006 by WAGO Kontakttechnik GmbH & Co. KG
All rights reserved.

WAGO Kontakttechnik GmbH & Co. KG

Hansastraße 27
D-32423 Minden

Phone: +49 (0) 571/8 87 – 0
Fax: +49 (0) 571/8 87 – 1 69
E-Mail: info@wago.com
Web: <http://www.wago.com>

Technical Support

Phone: +49 (0) 571/8 87 – 5 55
Fax: +49 (0) 571/8 87 – 85 55
E-Mail: support@wago.com

Every conceivable measure has been taken to ensure the correctness and completeness of this documentation. However, as errors can never be fully excluded, we would appreciate any information or ideas at any time.

E-Mail: documentation@wago.com

We wish to point out that the software and hardware terms as well as the trademarks of companies used and/or mentioned in the present manual are generally trademark or patent protected.

Content

1 Important Comments	4
1.1 Legal Principles	4
1.1.1 Copyright	4
1.1.2 Personnel Qualification	4
1.1.3 Intended Use	4
1.2 Symbols	5
1.3 Number Notation	5
1.4 Safety Notes	6
1.5 Scope	6
2 I/O Modules	7
2.1 Digital Output Modules	7
2.1.1 750-457 [4 AI DC ± 10 V, Single-Ended]	7
2.1.1.1 View	7
2.1.1.2 Description	7
2.1.1.3 Display Elements	8
2.1.1.4 Schematic Diagram	9
2.1.1.5 Technical Data	9
2.1.1.6 Process Image	11
2.1.1.6.1 Standard Data Format	12

1 Important Comments

To ensure fast installation and start-up of the units described in this manual, we strongly recommend that the following information and explanations are carefully read and abided by.

1.1 Legal Principles

1.1.1 Copyright

This manual is copyrighted, together with all figures and illustrations contained therein. Any use of this manual which infringes the copyright provisions stipulated herein, is not permitted. Reproduction, translation and electronic and photo-technical archiving and amendments require the written consent of WAGO Kontakttechnik GmbH & Co. KG. Non-observance will entail the right of claims for damages.

WAGO Kontakttechnik GmbH & Co. KG reserves the right to perform modifications allowed by technical progress. In case of grant of a patent or legal protection of utility patents all rights are reserved by WAGO Kontakttechnik GmbH & Co. KG. Products of other manufacturers are always named without referring to patent rights. The existence of such rights can therefore not be ruled out.

1.1.2 Personnel Qualification

The use of the product detailed in this manual is exclusively geared to specialists having qualifications in PLC programming, electrical specialists or persons instructed by electrical specialists who are also familiar with the valid standards. WAGO Kontakttechnik GmbH & Co. KG declines all liability resulting from improper action and damage to WAGO products and third party products due to non-observance of the information contained in this manual.

1.1.3 Intended Use

For each individual application, the components supplied are to work with a dedicated hardware and software configuration. Modifications are only permitted within the framework of the possibilities documented in the manuals. All other changes to the hardware and/or software and the non-conforming use of the components entail the exclusion of liability on part of WAGO Kontakttechnik GmbH & Co. KG.

Please direct any requirements pertaining to a modified and/or new hardware or software configuration directly to WAGO Kontakttechnik GmbH & Co. KG.

1.2 Symbols



Danger

Always abide by this information to protect persons from injury.



Warning

Always abide by this information to prevent damage to the device.



Attention

Marginal conditions must always be observed to ensure smooth operation.



ESD (Electrostatic Discharge)

Warning of damage to the components by electrostatic discharge. Observe the precautionary measure for handling components at risk.



Note

Routines or advice for efficient use of the device and software optimization.



More information

References on additional literature, manuals, data sheets and INTERNET pages

1.3 Number Notation

Number Code	Example	Note
Decimal	100	normal notation
Hexadecimal	0x64	C notation
Binary	'100' '0110.0100'	Within ', Nibble separated with dots

1.4 Safety Notes



Warning

Switch off the system prior to working on bus modules!

In the event of deformed contacts, the module in question is to be replaced, as its functionality can no longer be ensured on a long-term basis.

The components are not resistant against materials having seeping and insulating properties. Belonging to this group of materials is: e.g. aerosols, silicones, triglycerides (found in some hand creams).

If it cannot be ruled out that these materials appear in the component environment, then additional measures are to be taken:

- installation of the components into an appropriate enclosure
 - handling of the components only with clean tools and materials.
-



Attention

Cleaning of soiled contacts may only be done with ethyl alcohol and leather cloths. Thereby, the ESD information is to be regarded.

Do not use any contact spray. The spray may impair the functioning of the contact area.

The WAGO-I/O-SYSTEM 750 and its components are an open system. It must only be assembled in housings, cabinets or in electrical operation rooms. Access must only be given via a key or tool to authorized qualified personnel.

The relevant valid and applicable standards and guidelines concerning the installation of switch boxes are to be observed.



ESD (Electrostatic Discharge)

The modules are equipped with electronic components that may be destroyed by electrostatic discharge. When handling the modules, ensure that the environment (persons, workplace and packing) is well grounded. Avoid touching conductive components, e.g. gold contacts.

1.5 Scope

This manual describes the Analog Input Module 750-457
4 AI DC ± 10 V, Single-Ended of the modular WAGO-I/O-SYSTEM 750.

Handling, assembly and start-up are described in the manual of the Fieldbus Coupler. Therefore this documentation is valid only in the connection with the appropriate manual.

2 I/O Modules

2.1 Digital Output Modules

2.1.1 750-457 [4 AI DC ± 10 V, Single-Ended]

4-Channel Analog Input Module (± 10 V, Single-Ended)

2.1.1.1 View

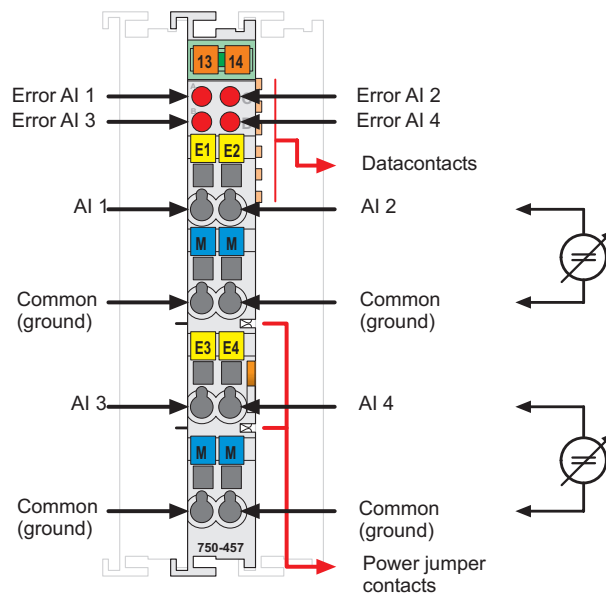

Fig. 2.1.1-1: 4-Channel Analog Input Module 750-457

g045700e

2.1.1.2 Description

This analog input module receives signals with standardized values of ± 10 V.

The module has four input channels. The fieldside signals may be received via the connections AI 1 and Common (ground) or AI 2, AI 3, AI 4 and Common (ground). The common (ground) contacts of all four channels have one common 0 V ground potential.

The input signal of each channel is electrically isolated and will be transmitted with a resolution of 12 bits.

Overrange or underflow of the measuring range is indicated via a red error LED.

Any configuration of the input modules is possible when designing the fieldbus node. Grouping of module types is not necessary

The voltage supply is done via system voltage.

The field side supply voltage of 24 V and 0 V for the input module is derived from adjacent I/O modules or from a supply module. The field supply voltage is passed on separately galvanically to following modules without own use. The supply voltage for the field side is made automatically through the individual I/O modules by means of power jumper contacts.



Warning

The maximum current of the internal power jumper contacts is 10 A. When configuring the system it is important not to exceed the maximum/sum current. However, if such a case should occur, another supply module must be added.

The analog input module 750-457 can be used with all couplers/controllers of the WAGO-I/O-SYSTEM 750 (except for the economy types 750-320, -323, -324 and -327).

2.1.1.3 Display Elements

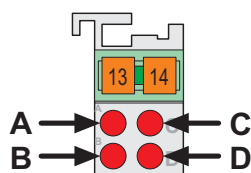

Fig. 2.1.1-2: Display Elements g045302x

LED	Channel	Meaning	State	Function
A red	1	Error AI 1	off	Normal operation
			on	Overrange/underflow of the admissible measuring range
C red	2	Error AI 2	off	Normal operation
			on	Overrange/underflow of the admissible measuring range
B red	3	Error AI 3	off	Normal operation
			on	Overrange/underflow of the admissible measuring range
D red	4	Error AI 4	off	Normal operation
			on	Overrange/underflow of the admissible measuring range

2.1.1.4 Schematic Diagram

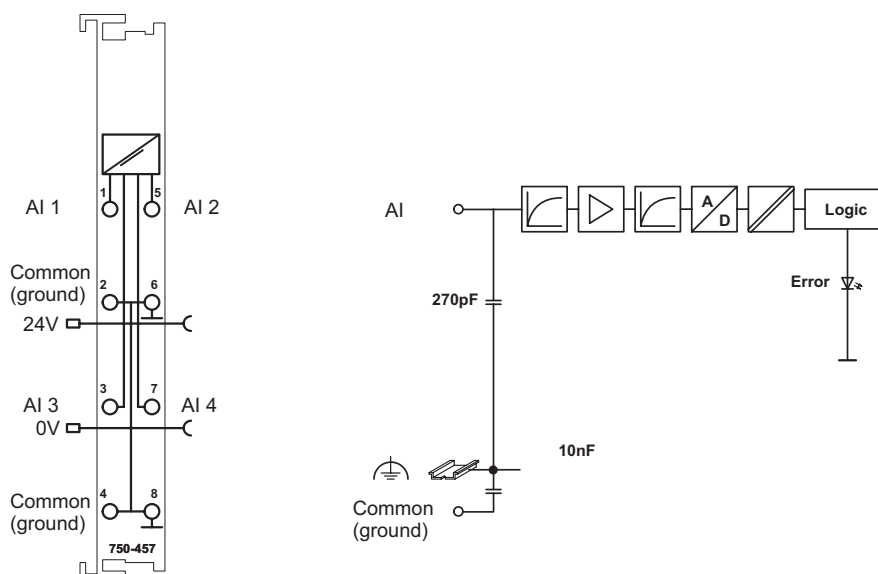











Fig. 2.1.1-3: 4-Channel Analog Input Module 750-457

g045701e

2.1.1.5 Technical Data

Module Specific Data	
Number of inputs	4
Voltage supply	via system voltage DC /DC
Current consumption _{typ.} (internal)	65 mA
Input voltage _{max.}	± 40 V
Signal current	± 10 V
Input resistance _{typ.}	>100 k Ω
Resolution	12 bits
Conversion time _{typ.}	10 ms
Measuring error _{25°C}	< ± 0.1 % of full scale value
Temperature coefficient	< ± 0.01 % /K of full scale value
Isolation	500 V (Field/System)
Bit width	4 x 16 bits data 4 x 8 bits control/status (option)
Dimensions (mm) W x H x L	12 x 64* x 100 * from upper edge of 35 DIN rail
Weight	ca. 55 g

Standards and Regulations (cf. Chapter 2.2 of the Coupler/Controller Manual)		
EMC-Immunity to interference (CE)	acc. to EN 50082-2 (96)	
EMC-Emission of interference (CE)	acc. to EN 50081-1 (93)	
EMC-Immunity to interference (Ship building)	acc. to Germanischer Lloyd (01)	
EMC-Emission of interference (Ship building)	acc. to Germanischer Lloyd (01)	
Approvals (cf. Chapter 2.2 of the Coupler/Controller Manual)		
	cUL _{US} (UL508)	
	ABS (American Bureau of Shipping)	
	BV (Bureau Veritas) (applied for)	
	DNV (Det Norske Veritas)	Cl. B
	GL (Germanischer Lloyd)	Cat. A, B, C, D
	KR (Korean Register of Shipping)	
	LR (Lloyd's Register) (applied for)	Env. 1, 2, 3, 4
	NKK (Nippon Kaiji Kyokai)	
	cUL _{US} (UL1604)	Class I Div2 ABCD T4A
	KEMA	II 3 G EEx nA II T4
	Conformity Marking	



More Information

Detailed references to the approvals are listed in the document "Overview Approvals WAGO-I/O-SYSTEM 750", which you can find on the CD ROM ELECTRONICC Tools and Docs (Item-No.: 0888-0412)

or in the internet under:

www.wago.com → Documentation → WAGO-I/O-SYSTEM 750 → System Description

2.1.1.6 Process Image

The analog input module 750-457 transmits 16-bit measured values and 8 optional status bits per channel.

The digitalized measured value is transmitted in a data word (16 bits) as input byte 0 (low) and input byte 1 (high) into the process image of the coupler / controller.

This value is represented with a 12 bit resolution on bit B3 ... B14.

The status information included in the three least significant bits (B0 ... B2) can be parsed in the event of an error. Bit B0 and B1 = 1 are set when the range of measurement is overranged or underflow. Bit B2 is not defined and not evaluated. Therefore, they are represented with a 'X' in the table.

Some fieldbus systems can process input channel status information by means of a status byte.

This status byte can be displayed using the starting tool WAGO-I/O-CHECK 2. However, the coupler / controller process operation is optional, which means that accessing or parsing the status information depends on the fieldbus system.



Attention

The representation of the process data of some fieldbus modules or their variations in the process image depends on the fieldbus coupler/-controller used. Please take this information as well as the particular design of the respective control/status bytes from the section "Fieldbus specific design of the process data" included in the description of the process image of the corresponding coupler/controller.

2.1.1.6.1 Standard Data Format

For the standard module 750-457, the input voltage ranging from -10 V to +10 V is scaled on the numerical values ranging from 0x8000 to 0x7FFF.

Process values of module 750-457						
Input voltage ± 10 V	Numerical value			Status- byte hex.	LED Error AI 1-4	
	binary Measured value	* ⁾ X F Ü	hex. dec.			
<-10	'1000.0000.0000.0	X11'	0x8003 -32765	0x41	on	
-10	'1000.0000.0000.0	X00'	0x8000 -32768	0x00	off	
-8	'1001.1001.1001.1	X00'	0x9998 -26214	0x00	off	
-6	'1011.0011.0011.0	X00'	0xB334 -19660	0x00	off	
-4	'1100.1100.1100.1	X00'	0xCCCC -13107	0x00	off	
-2	'1110.0110.0110.0	X00'	0xE664 -6553	0x00	off	
0	'0000.0000.0000.0	X00'	0x0000 0	0x00	off	
2	'0001.1001.1001.1	X00'	0x1998 6553	0x00	off	
4	'0011.0011.0011.0	X00'	0x3330 13107	0x00	off	
6	'0100.1100.1100.1	X00'	0x4CCC 19660	0x00	off	
8	'0110.0110.0110.0	X00'	0x6664 26214	0x00	off	
10	'0111.1111.1111.1	X00'	0x7FFC 32764	0x00	off	
>10	'0111.1111.1111.1	X11'	0x7FFF 32767	0x42	on	

*⁾ status bits: X = not used, F = short-circuit, Ü = oversize



WAGO Kontakttechnik GmbH & Co. KG
Postfach 2880 • D-32385 Minden
Hansastraße 27 • D-32423 Minden
Phone: 05 71/8 87 – 0
Fax: 05 71/8 87 – 1 69
E-Mail: info@wago.com

Internet: <http://www.wago.com>
