

WAGO → I/O → SYSTEM 750

Fieldbus Independent I/O Modules

4 AO DC 0-20 mA

750-553



Manual

Version 1.0.1

Copyright © 2006 by WAGO Kontakttechnik GmbH & Co. KG
All rights reserved.

WAGO Kontakttechnik GmbH & Co. KG

Hansastraße 27
D-32423 Minden

Phone: +49 (0) 571/8 87 – 0
Fax: +49 (0) 571/8 87 – 1 69

E-Mail: info@wago.com

Web: <http://www.wago.com>

Technical Support

Phone: +49 (0) 571/8 87 – 5 55
Fax: +49 (0) 571/8 87 – 85 55

E-Mail: support@wago.com

Every conceivable measure has been taken to ensure the correctness and completeness of this documentation. However, as errors can never be fully excluded, we would appreciate any information or ideas at any time.

E-Mail: documentation@wago.com

We wish to point out that the software and hardware terms as well as the trademarks of companies used and/or mentioned in the present manual are generally trademark or patent protected.

Content

1 Important Comments	4
1.1 Legal Principles	4
1.1.1 Copyright	4
1.1.2 Personnel Qualification	4
1.1.3 Intended Use	4
1.2 Symbols	5
1.3 Number Notation	5
1.4 Safety Notes	6
1.5 Scope	6
2 I/O Modules	7
2.1 Analog Output Modules	7
2.1.1 750-553 [4 AO DC 0-20 mA]	7
2.1.1.1 View	7
2.1.1.2 Description	7
2.1.1.3 Display Elements	8
2.1.1.4 Schematic Diagram	9
2.1.1.5 Technical Data	10
2.1.1.6 Process Image	11
2.1.1.6.1 Standard Format	11

1 Important Comments

To ensure fast installation and start-up of the units described in this manual, we strongly recommend that the following information and explanations are carefully read and abided by.

1.1 Legal Principles

1.1.1 Copyright

This manual is copyrighted, together with all figures and illustrations contained therein. Any use of this manual which infringes the copyright provisions stipulated herein, is not permitted. Reproduction, translation and electronic and photo-technical archiving and amendments require the written consent of WAGO Kontakttechnik GmbH & Co. KG. Non-observance will entail the right of claims for damages.

WAGO Kontakttechnik GmbH & Co. KG reserves the right to perform modifications allowed by technical progress. In case of grant of a patent or legal protection of utility patents all rights are reserved by WAGO Kontakttechnik GmbH & Co. KG. Products of other manufacturers are always named without referring to patent rights. The existence of such rights can therefore not be ruled out.

1.1.2 Personnel Qualification

The use of the product detailed in this manual is exclusively geared to specialists having qualifications in PLC programming, electrical specialists or persons instructed by electrical specialists who are also familiar with the valid standards. WAGO Kontakttechnik GmbH & Co. KG declines all liability resulting from improper action and damage to WAGO products and third party products due to non-observance of the information contained in this manual.

1.1.3 Intended Use

For each individual application, the components supplied are to work with a dedicated hardware and software configuration. Modifications are only permitted within the framework of the possibilities documented in the manuals. All other changes to the hardware and/or software and the non-conforming use of the components entail the exclusion of liability on part of WAGO Kontakttechnik GmbH & Co. KG.

Please direct any requirements pertaining to a modified and/or new hardware or software configuration directly to WAGO Kontakttechnik GmbH & Co. KG.

1.2 Symbols



Danger

Always abide by this information to protect persons from injury.



Warning

Always abide by this information to prevent damage to the device.



Attention

Marginal conditions must always be observed to ensure smooth operation.



ESD (Electrostatic Discharge)

Warning of damage to the components by electrostatic discharge. Observe the precautionary measure for handling components at risk.



Note

Routines or advice for efficient use of the device and software optimization.



More information

References on additional literature, manuals, data sheets and INTERNET pages

1.3 Number Notation

Number Code	Example	Note
Decimal	100	normal notation
Hexadecimal	0x64	C notation
Binary	'100' '0110.0100'	Within ', Nibble separated with dots

1.4 Safety Notes



Warning

Switch off the system prior to working on bus modules!

In the event of deformed contacts, the module in question is to be replaced, as its functionality can no longer be ensured on a long-term basis.

The components are not resistant against materials having seeping and insulating properties. Belonging to this group of materials is: e.g. aerosols, silicones, triglycerides (found in some hand creams).

If it cannot be ruled out that these materials appear in the component environment, then additional measures are to be taken:

- installation of the components into an appropriate enclosure
 - handling of the components only with clean tools and materials.
-



Attention

Cleaning of soiled contacts may only be done with ethyl alcohol and leather cloths. Thereby, the ESD information is to be regarded.

Do not use any contact spray. The spray may impair the functioning of the contact area.

The WAGO-I/O-SYSTEM 750 and its components are an open system. It must only be assembled in housings, cabinets or in electrical operation rooms. Access must only be given via a key or tool to authorized qualified personnel.

The relevant valid and applicable standards and guidelines concerning the installation of switch boxes are to be observed.



ESD (Electrostatic Discharge)

The modules are equipped with electronic components that may be destroyed by electrostatic discharge. When handling the modules, ensure that the environment (persons, workplace and packing) is well grounded. Avoid touching conductive components, e.g. gold contacts.

1.5 Scope

This manual describes the Analog Output Module 750-553
4 AO DC 0-20 mA of the modular WAGO-I/O-SYSTEM 750.

Handling, assembly and start-up are described in the manual of the Fieldbus Coupler. Therefore this documentation is valid only in the connection with the appropriate manual.

2 I/O Modules

2.1 Analog Output Modules

2.1.1 750-553 [4 AO DC 0-20 mA]

4-Channel Analog Output Module 0 – 20 mA

2.1.1.1 View

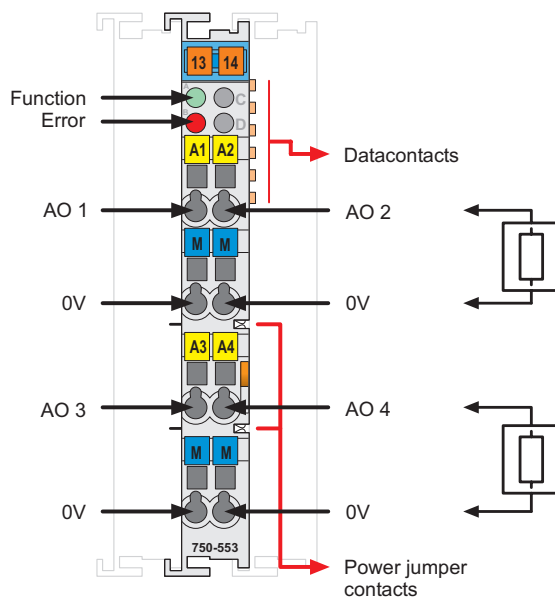

Fig. 2.1.1-1: View

g055300e

2.1.1.2 Description

The analog output module 750-553 creates a standardized signal of 0 – 20 mA.

The module has four output channels and enables, for example, the direct wiring of four 2-conductor actuators to the connections AO 1 and Common (ground) or AO 2, AO 3, AO 4 and each with Common (ground). The signals are transmitted via AO 1, AO 2, AO 3 or AO 4. The channels have a common ground.



Attention

All load impedances connected to the outputs of one I/O module have to be either in the range of 0 ... 300 Ω or 300 ... 600 Ω. The load impedances are checked by the I/O module and inadmissible load combinations will cause an error message.

The input signal is electrically isolated and will be transmitted with a resolution of 12 bits.

The operational readiness and the trouble-free internal data bus communication of the channels are indicated via a green function LED.

In addition, a red error LED will show if there are any broken wire or inadmissible load combinations.

Any configuration of the output modules is possible when designing the fieldbus node. Grouping of module types is not necessary.

The field side supply voltage is used for the power supply of the module.

The field side supply voltage of 0 V and 24 V to downstream I/O modules is derived from adjacent I/O modules or from a supply module. The supply voltage for the field side is made automatically through the individual I/O modules by means of power jumper contacts.



Warning

The maximum current of the internal power jumper contacts is 10 A. When configuring the system it is important not to exceed the maximum/sum current. However, if such a case should occur, another supply module must be added.

The analog output module 750-553 can be used with all couplers/controllers of the WAGO-I/O-SYSTEM 750 (except for the economy types 750-320, -323, -324 and -327).

2.1.1.3 Display Elements

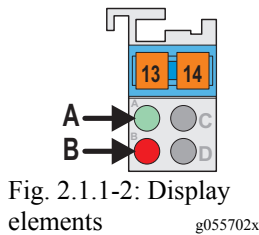

Fig. 2.1.1-2: Display elements g055702x

LED	Designation	State	Function
A green	Function	off	No operational readiness or the internal data bus communication is interrupted
		on	Operational readiness and trouble-free internal data bus communication
B red	Error	off	No Error
		on	Broken wire or inadmissible load combination

2.1.1.4 Schematic Diagram

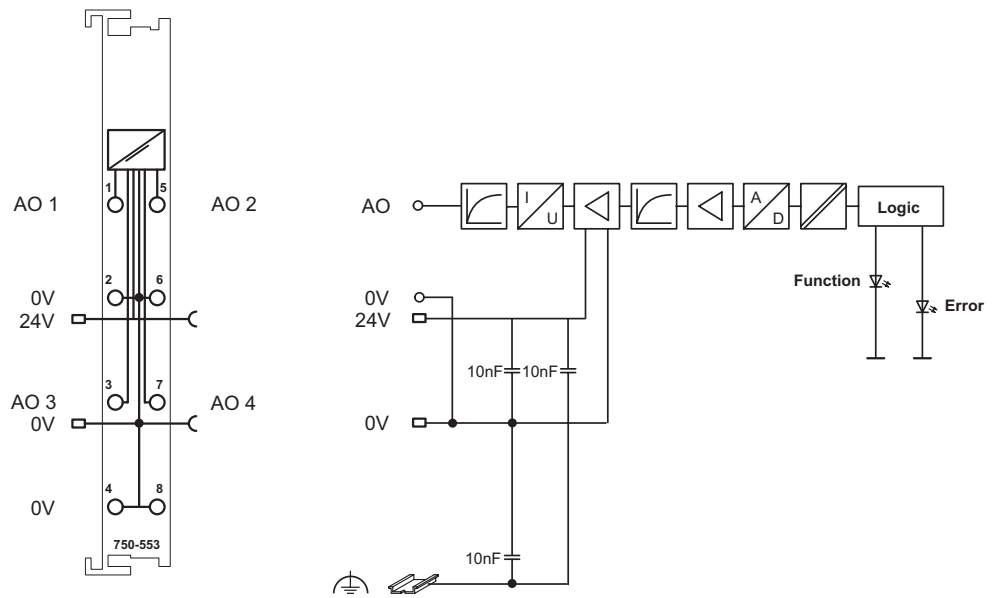









Fig. 2.1.1-3: Schematic diagram

g055301e

2.1.1.5 Technical Data

Module Specific Data		
Number of outputs	4	
Voltage supply	via power jumper contacts DC 24 V (-15% ... +20%)	
Current consumption _{typ.} (internal)	60 mA	
Signal voltage	0 ... 20 mA	
Load impedance	either 0 ... 300 Ω or 300 ... 600 Ω (use same range of impedances for all loads!)	
Resolution	12 bit	
Conversion time _{typ.}	10 ms	
Output filter settle time _{typ.}	100 ms	
Measuring error _{25°C}	<± 0.1 % of the full scale value	
Temperature coefficient	<± 0.01 % /K of the full scale value	
Isolation	500 V (field / system)	
Bit width	4 x 16 bits data 4 x 8 bits control / status (option)	
Dimensions W x H* x L * from upper edge of 35 DIN rail	12 mm x 64 mm x 100 mm	
Weight	ca. 55 g	
Standards and Regulations (cf. Chapter 2.2 of the Coupler/Controller Manual)		
EMC-Immunity to interference (CE)	acc. to EN 50082-2 (96)	
EMC-Emission of interference (CE)	acc. to EN 50081-1 (93)	
Approvals (cf. Chapter 2.2 of the Coupler/Controller Manual)		
 cUL _{US}	cUL _{US} (UL508)	
	ABS (American Bureau of Shipping)	
	BV (Bureau Veritas) (applied for)	
	GL (Germanischer Lloyd) (applied for)	Cat. A, B, C, D
	KR (Korean Register of Shipping)	
	LR (Lloyd's Register) (applied for)	Env. 1, 2, 3, 4
	NKK (Nippon Kaiji Kyokai)	
 cUL _{US}	cUL _{US} (UL1604)	Class I Div2 ABCD T4A
	KEMA	II 3 G EEx nA II T4
	Conformity Marking	



More Information

Detailed references to the approvals are listed in the document "Overview Approvals WAGO-I/O-SYSTEM 750", which you can find on the CD ROM ELECTRONICC Tools and Docs (Item-No.: 0888-0412) or in the internet under:

www.wago.com → Documentation → WAGO-I/O-SYSTEM 750 → System Description

2.1.1.6 Process Image

The analog output module 750-553 transmits 16-bit data and 8 status bits per channel.

The digitalized output value is transmitted in a data word (16 bits) as output byte 0 (low) and output byte 1 (high) via the process image of the coupler / controller.

This value is represented with a 12 bit resolution on bit B3 ... B14.

The three least significant bits (B0 ... B2) are not parsed.

Some fieldbus systems can process the status information using by means of a status byte.

However, processing of the status byte via the coupler / controller is optional, which means that accessing or parsing the status information depends on the fieldbus system.

2.1.1.6.1 Standard Format

For the standard module 750-553, the numerical values ranging from 0x0000 to 0x7FFF are scaled on the output current ranging from 0 mA to 20 mA.

Process values of module 750-553					
Output-current 0 – 20 mA	numerical value			Status-byte hex.	Error-LED
	binary output value	hex.	dec.		
0	'0000.0000.0000.0000'	0x0000	0	0x00	off
5	'0001.1111.1111.1111'	0x1FFF	8191	0x00	off
10	'0011.1111.1111.1111'	0x3FFF	16383	0x00	off
15	'0101.1111.1111.1111'	0x5FFF	24575	0x00	off
20	'0111.1111.1111.1111'	0x7FFF	32767	0x00	off
Broken wire or inadmissible load combination	'XXXX.XXXX.XXXX.XXXX'	0xFFFF	X	0x40	on



WAGO Kontakttechnik GmbH & Co. KG
Postfach 2880 • D-32385 Minden
Hansastraße 27 • D-32423 Minden
Phone: 05 71/8 87 – 0
Fax: 05 71/8 87 – 1 69
E-Mail: info@wago.com

Internet: <http://www.wago.com>
