

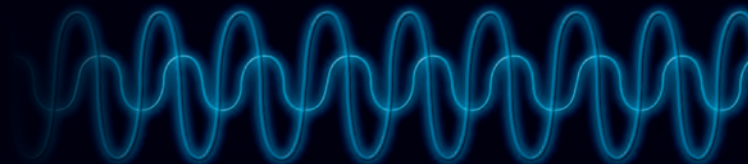

Logic controllers  
Concentrated performance

**Millenium3** Smart & Essential

# Content



<a href="#">Presentation</a>	<a href="#">P. 3</a>
<a href="#">Millenium 3</a>	<a href="#">P. 4</a>
<a href="#">The range</a>	<a href="#">P. 5</a>
<a href="#">Communication solutions</a>	<a href="#">P. 6</a>
<a href="#">M3 Soft software</a>	<a href="#">P. 8</a>
<a href="#">Accessories</a>	<a href="#">P. 9</a>
<a href="#">Applications</a>	<a href="#">P. 10</a>
<a href="#">Selection guide</a>	<a href="#">P. 12</a>
<a href="#">Technical data</a>	<a href="#">P. 14</a>
Millenium 3 Smart	p. 15
Millenium 3 Essential	p. 21
Extensions	p. 23
Input/Output Connection Diagrams	p. 30
Bare Board and Resin Board Versions	p. 35
General characteristics	p. 39
Power supplies and converters	p. 44
Accessories	p. 47
<a href="#">Glossary of function blocks</a>	<a href="#">P. 68</a>
<a href="#">Selection process</a>	<a href="#">P. 70</a>
<a href="#">Part numbers index</a>	<a href="#">P. 72</a>

# Presentation

## Crouzet Automation,

Supported by an experienced technical team,

Crouzet Automation is a pioneer in the simplification of programming. The brand offers the easiest-to-use and most adaptable alternative automation solution for specialized and demanding needs.

These products are specifically suited for integration in a **wide range of applications** such as waste and water treatment, access control, renewable energies, building equipment, industrial machines and transportation.

## InnoVista Sensors™:

your trusted partner of choice to face industrial challenges of today and tomorrow.

InnoVista Sensors™ is a worldwide industrial specialist of sensors, controllers and actuators for automated systems.

Through its brands, Crouzet Aerospace, Crouzet Automation, Crouzet Control, Crouzet Motors, Crouzet Switches and Systron Donner Inertial, InnoVista Sensors™ offers a wide range of reliable, efficient and customizable components dedicated to the Aerospace & Defence, Transportation and Industrial market and segments.

Thanks to the recognized expertise of its teams and a strong innovation policy, InnoVista Sensors™ brings performance enhancing solutions to its customers worldwide.

[www.innovistasensors.com](http://www.innovistasensors.com)

Crouzet Automation presence worldwide



# Millenium 3

## Crouzet Automation Logic Controllers

### Millenium 3, concentrated performance

The **Millenium 3 Smart** is a programmable logic controller which enables the control and monitoring of machines or automation installations with up to 50 I/O.

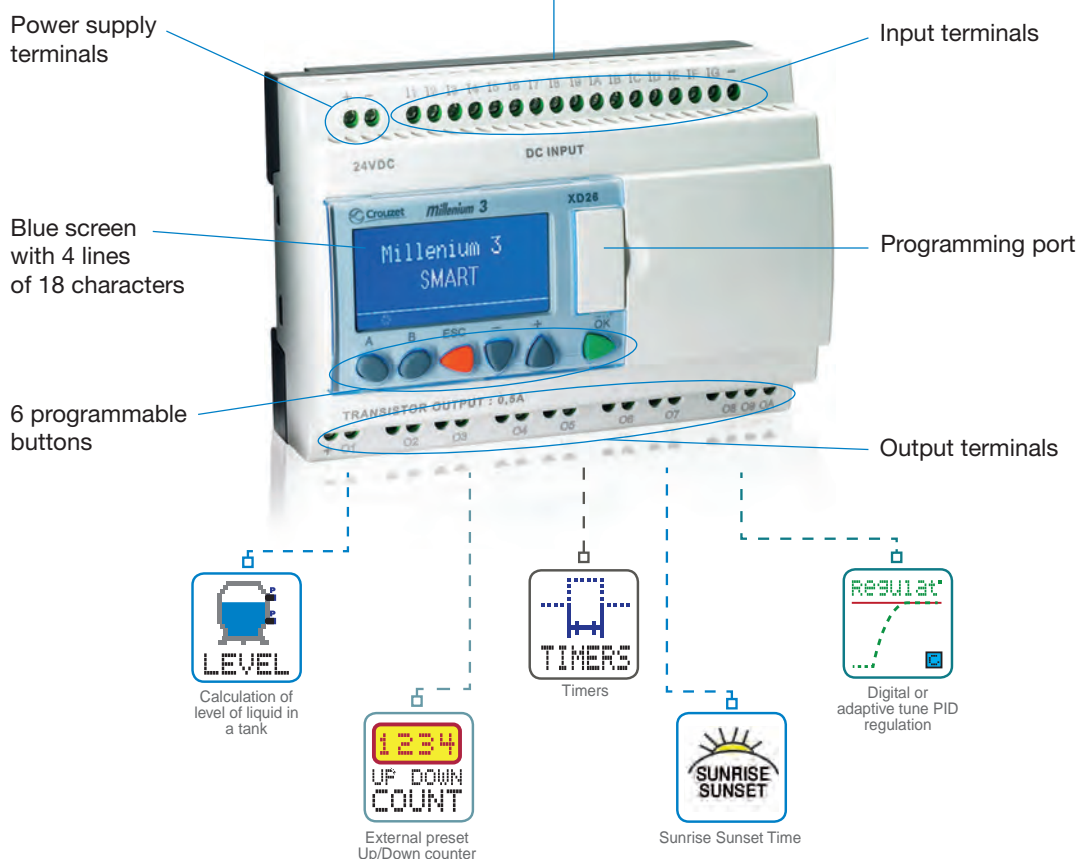
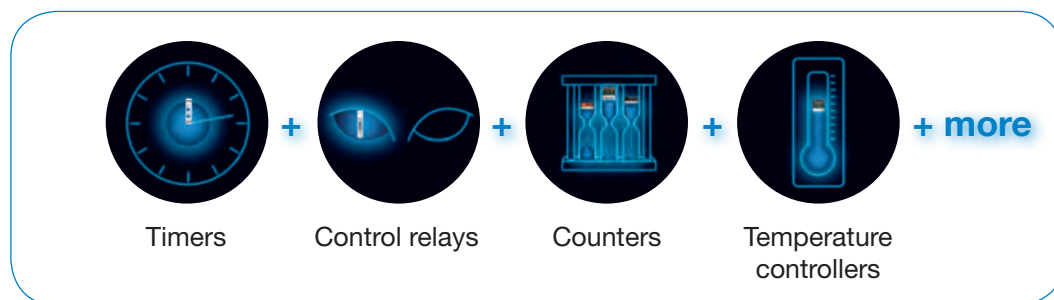

To tackle simpler applications that still require a powerful logic controller, Crouzet Automation offers the Millenium 3 **“Essential”** range. The 12 VDC or 24 VDC Millenium 3 Essential range includes a variety of versions and is compatible with a large range of accessories. It is the right solution for simple needs.

# The range

## Crouzet Automation Logic Controllers

### The Millenium 3 Smart range

- **Multiple configuration options** derived from an extensive product range with numerous accessories
- **Simplified connectivity** making integration of communication systems easy
- **Easy implementation** supported by free, user-friendly programming software (M3 Soft)
- **Application-specific solutions** thanks to dedicated and easy to use specific function blocks
- **Enhanced visibility** on the display with high contrast, blue back lit LCD screen

#### Expandable versions



XD26

XB26



XD10

XB10



Expandable kit

#### Compact versions



CD20

CB20



CD12

CB12



Compact kit

# Communication solutions

## Crouzet Automation Logic Controllers Extensive Connectivity Options

### Solutions with close proximity to your installation

#### Millenium 3 Virtual Display - Bluetooth® or USB

##### Your requirements

- **Viewing** setpoints on a panel less than 10 m away
- **Changing and modifying** setpoints
- **Locating the** Millenium 3 display unit remotely
- **Reading** counters in the vicinity

##### Our solution

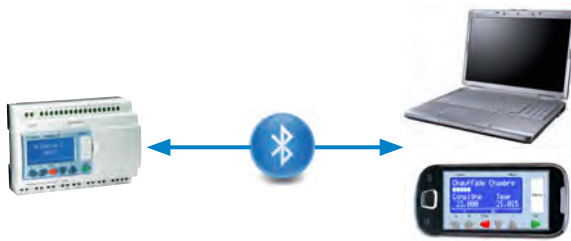

##### Main functions

- **Remote viewing** of the Millenium 3 display unit
  - on an Android smartphone via Bluetooth®
  - on a PC via Bluetooth® or USB
- **Display/modification** of program setpoints
- Access to a **virtual panel** (Millenium 3 without display unit)

##### In summary

- **Bluetooth® interface** (10 m): Millenium 3 accessory
- Two versions: **Lite** (ESC/ENTER buttons disabled) & **Standard**

See also page 48

#### MTP programmable touch panels - RS232 cable

##### Your requirements

- **Displaying** data on a graphic panel
- **Modifying setpoints** from the touch panel
- **Taking control of the** remote panel from a distance

##### Our solution

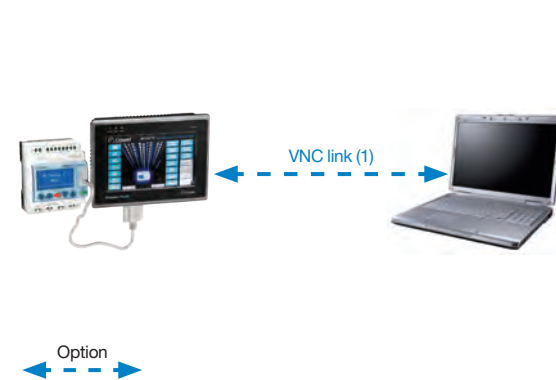

##### Main functions

- **Supervision** of your installation
- **Use** of Millenium 3 internal data, processing alarms and recipes
- **Display** of text, data, graphics, animations
- **Archiving** of data
- **Customization** of interfaces (picture library)
- **Remote control** of panel

##### In summary

- **Storage**: 128 MB flash memory, SD card and USB key
- **Direct communication** using the Millenium 3 programming port
- **Programmable** with EB software (compatible with Windows 2000/XP/Vista/7)
- **Extensive connectivity**

See also page 49

(1) VNC: Virtual Network Computing. Allows a device to be controlled remotely.

### Local Area Network (LAN) solutions

#### Programmable touch panels and communication extensions – Modbus networks

##### Your requirements

- **Managing a group of machines** or an installation on a local area network
- **Centralizing** data
- **Displaying** data on a graphic panel
- **Modifying setpoints** from the panel
- Accessing the system locally **in real time**

##### Our solution

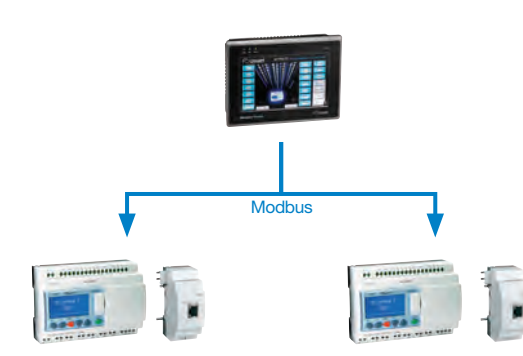

##### Main functions

- See MTP programmable touch panels solution
- **Management** and **centralizing** of data in a single place
- **Display** of Millenium 3 program values
- **Remote** setpoint **modification**

##### In summary

- MTP panel **Modbus master**
- XN05 extension: **Modbus Ethernet TCP/IP**
- XN06 extension: **Modbus RS485 RTU**

See also page 23 and 49

## Wide Area Network (WAN) solutions

### M3MOD - GSM modem communication interface

#### Your requirements

- Receiving **remote early warning** of an event
- **Consulting a value** or an internal state
- **Occasionally modifying** setpoints

#### Our solution

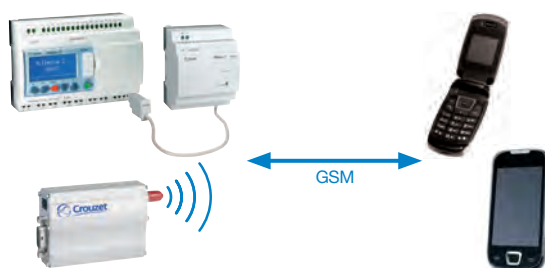

#### Main functions

- **Automatic notificatio** of alarms via SMS
- Input and output states, as well as all program values, **can be polled and controlled remotely**
- **Reports** can be produced using the available variables
- Management of **telephone contacts**

#### In summary

- Reliable **plug & play** solution that is simple to install
- Solution managed using **M3 Soft** software
- Option **to send SMS messages** via a telecom operator service

See also page 55

### Remote management solutions with **HMS**<sup>(2)</sup> - Cloud

#### Your requirements

- **Supervising and monitoring** installations with up to 50 remote I/O
- Managing **an installed base of machines**
- Accessing your data remotely, **24/7**
- Optimizing your **maintenance operations**

#### Our solution

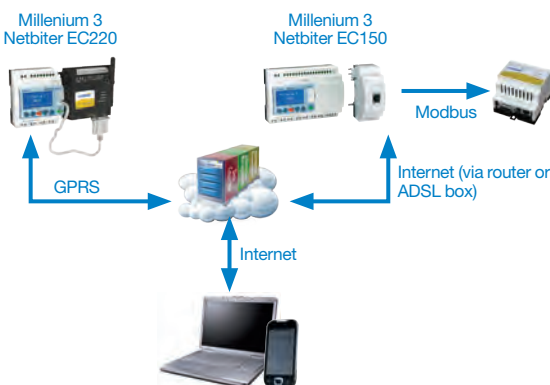

#### Main functions

- **Remote control** of an automated application
- **Display** of Millenium 3 program parameters and values **via the internet**
- **Remote** setpoint **modificatio**
- **Data logging**
- Management of **events** sent **via emails or SMS**

#### In summary

- **Direct communication** between Netbiter and Millenium 3 via the SLin/SLout protocol or via Modbus
- **GPRS**: SIM card procured via HMS
- **Cloud solution**: secure remote server
- **Easy** to set up and use
- **Several Millenium 3** can be connected via Modbus

(2) Partnership solutions with the HMS company, validated by Crozet Automation and HMS. Information relating to the products has been provided by the supplier of each product respectively, and they are wholly responsible for its accuracy in addition to supplying and providing backup for their products.

### Communication extensions - Modbus RS485 or Modbus Ethernet TCP/IP

#### Your requirements

- **Managing a group of machines** or an installation on a local area network
- **Centralizing** data
- Accessing the system locally **in real time**

#### Our solution

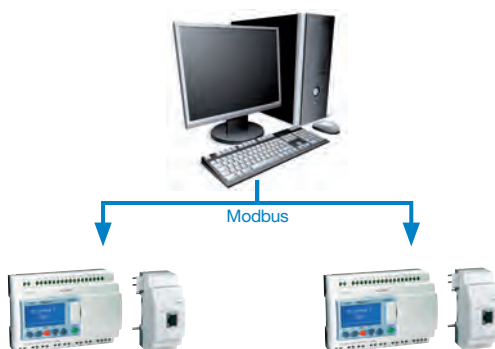

#### Main functions

- Can be **combined with distributed automation**
- Management and **centralizing of data** in a single place
- **Display** of Millenium 3 program values
- **Remote** setpoint **modificatio**

#### In summary

- Uses **Modbus protocol**
- XN05 extension: **Modbus Ethernet TCP/IP**
- XN06 extension: **Modbus RS485 RTU**
- **Compatible** with standard supervisors

See also page 23

# M3 Soft software

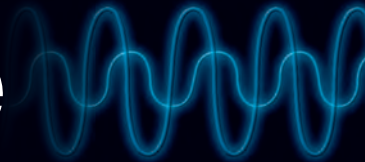

## Crouzet Automation Logic Controllers

### Millenium 3 and M3 Soft

The M3 Soft is a **high-performance** software platform used to program the Millenium 3 logic controller and **optimize** design times.



#### Free

The Millenium 3 programming software (M3 Soft) can be **downloaded free of charge** from the Crouzet website at [www.crouzet.com](http://www.crouzet.com)

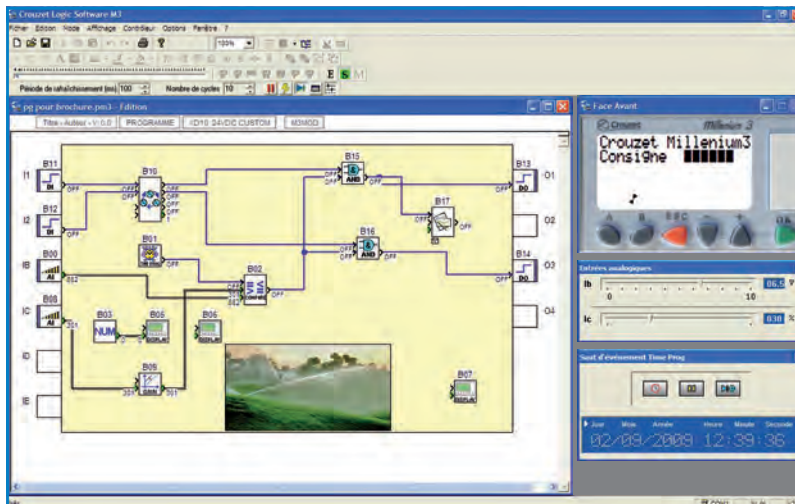

Blocks can be wired in wiring mode or text mode

Move one or more blocks without disconnecting the wires

Choice of programming language

Clear work area

Customized password protection

#### Simple

- **Quick, simple and intuitive programming** requires no specialist knowledge
- Self-teaching made easier thanks to a **user-friendly online help guide** and programming examples
- A **simulation mode** that **consistently represents** controller operation

#### Powerful

- A complete range of **basic functions**: counting, timing, comparison, display, logic, gain, sin/cos, etc are also available
- A wide range of **dedicated functions**: pump rotation, PID regulation, movement, pressure, level, water ratio, solar tracking, and flow

#### User-friendly and ergonomic

- Software available in **5 languages**: English, French, Italian, German and Spanish
- Function block **programming is fun** and **very visual**
- **Blocks simply organized** by function for quick access
- **Help** associated with each function block accessible **at the click of a button**
- Programming languages: **FBD** (Function Bloc Diagram) and **SFC** (Sequential Function Chart/Grafset) or **LD** (Ladder Diagram)

#### User-definable and effective

- Possibility of creating and saving **custom macros** in the macro tab allowing the user to simplify programs and utilize their expertise
- Possibility of protecting macros by locking them with a password for **greater security**



## Crouzet Automation Logic Controllers

### Accessories

Sensors, power supplies, converters, remote screens and communication accessories offer solutions to control your automation systems with the greatest ease of use.

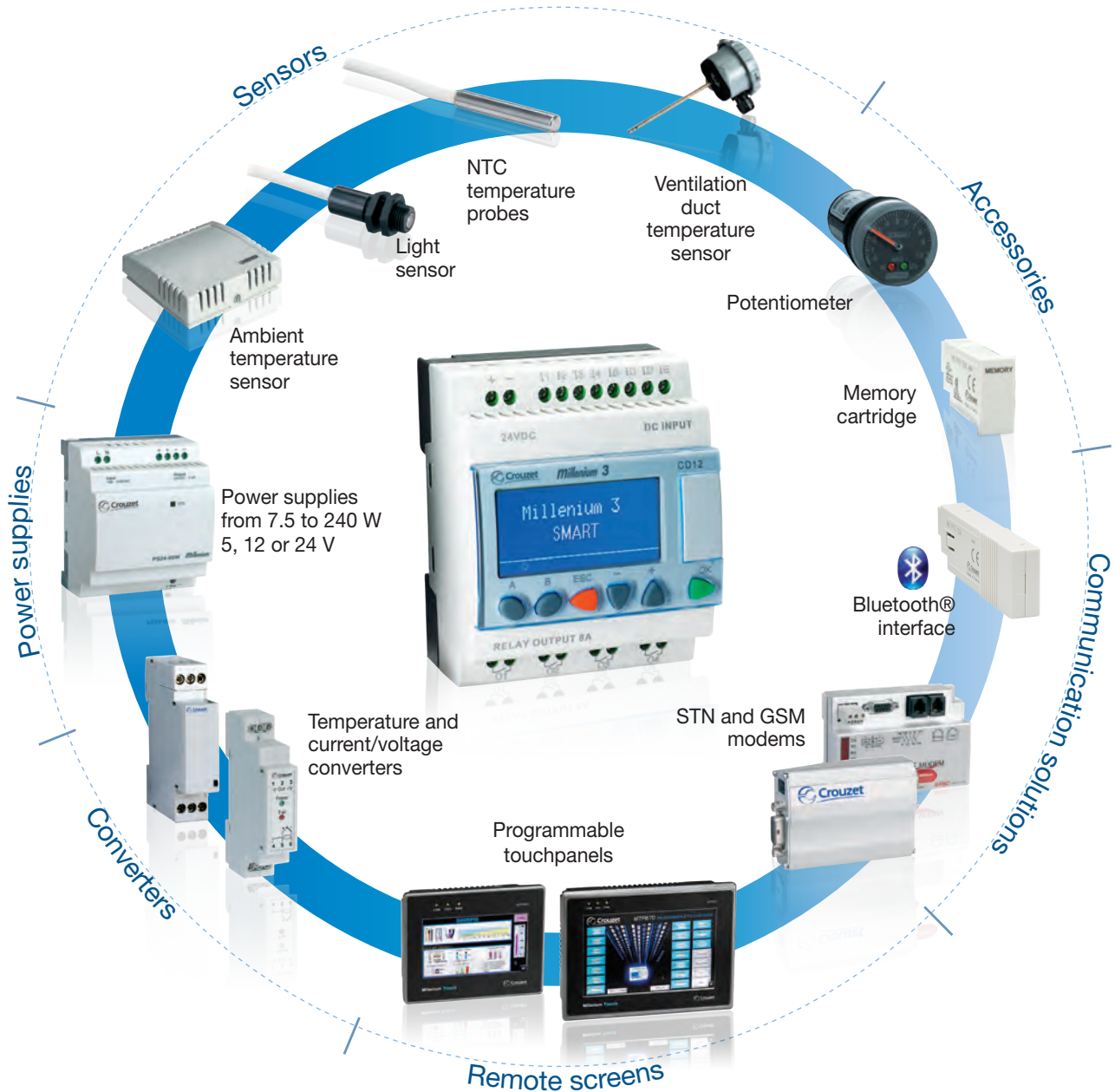

# Applications

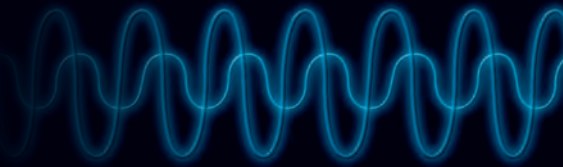

## Crouzet Automation Logic Controllers

### Where are they found?

#### Building Equipment

##### Access Control

**Opening control for doors**



Control opening and closing of doors and other associated security devices for restricting access; synchronization between the various doors



**BOOLEAN OR LOGIC**  
Create logic equations between the connected inputs

**Automatic barriers**



Control barriers with automatic detection of vehicles.  
Function for selecting opening times / days.





**UP/DOWN COUNTER**  
Up/Down counter with external preset

##### HVAC

**Heat pump**



Management of various parameters such as heating, cooling, fluid temperatures, operation, calendar-based function, frost protection mode, alarm management, etc



**WATER RATIO**  
Water temperature control

**CLOCK**  
Weekly and yearly time programmer

**Air treatment plant**



Maintaining forced air at the correct temperature

**NTC1**  
Temperature measurement

**REGULATION**  
Analog PID regulation

**GAIN**  
Conversion of an analog value by changing the scale and datum point

##### Building Automation

**Solar water heating**



Automation of operation and heating regulation, remote management of the installation





**TEMPERATURE CONTROL**  
(pressure or other)

**Illuminated signs**



Managing flashing on illuminated signs

**WEEKLY TIME PROGRAMMER**  
Programming of time slots during which it will be possible to execute actions

**LUX-I**  
Measurement of the light level

**TWILIGHT**  
Calculation of the sunrise and sunset times

## Infrastructure and Energy

### Fluid management

#### Swimming pools, fountains, spas



Managing circulation pumps, monitoring levels, temperature and conductivity of the water



**FILTRATION**  
Filtration duration settings depending on the water temperature

#### Irrigation/Sprinklers



Irrigation control based on temperature, humidity, and day/night cycle



**PUMP MANAGEMENT**  
Pump rotation function

### Water treatment

#### Reverse osmosis



Circulation pumps management, supervision of flow pressure and temperature of osmosis processed water



**FLOW**  
Calculation of the flow of a liquid in a pipe

**CTN**  
Temperature measurement (-35 to +120 °C)

#### Pump management



Circulation pumps management, supervision of levels and pressure



**GAIN**  
Conversion of an analog value by changing the scale and datum point

**LEVEL**  
Calculation of the level of liquid in a tank

## Industrial OEMs

### Packing machines

#### Stretch wrapping machines

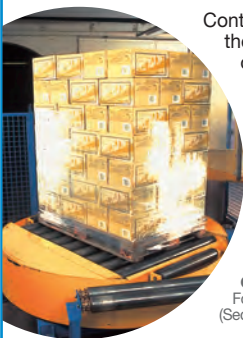

Controlling the motor that unrolls the packing film. Controls cutting of the film after heat sealing and monitors the duration of the motor cycles

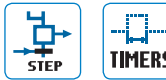

**GRAFSET SFC FUNCTIONS**  
For sequential automation systems (Sequential Function Chart)

**TIMERS (TEMPORISATEURS)**  
A/C function - BW function - B/H function - L/L function

#### Packaging



Controlling heat sealing times on blister packs, packaging bags, etc



**HIGH SPEED COUNT**  
Counting of pulses











**AND**  
Logical AND with 2 inputs

### Other typical applications:

Medical, Solar, Agricultural Equipment, Transportation, Hoisting, Handling...

# Selection guide

## Millenium 3 range

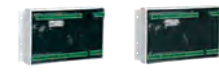
Type	Part number	Supply	Inputs	Outputs	Available in		Available with Solid State Output 0.5 A/PWM	Available in / compatible with the Essential version**	Page
					12 V $\overline{\text{---}}$	24 V $\sim$			
<b>M3 Smart kits</b> 	Kit 12 Smart*	88 974 080	24 V $\overline{\text{---}}$	8 (4 configurable as analog)	4 relays 8 A				14
	Kit 12 Smart*	88 974 081	100 $\Rightarrow$ 240 V $\sim$	8	4 relays 8 A				14
	Kit 20 Smart*	88 974 082	24 V $\overline{\text{---}}$	12 (6 configurable as analog)	8 relays 8 A				14
	Kit 20 Smart*	88 974 083	100 $\Rightarrow$ 240 V $\sim$	12	8 relays 8 A				14
	Kit 26 Smart*	88 974 084	24 V $\overline{\text{---}}$	16 (6 configurable as analog)	8 relays 8 A and 2 relays 5 A				14
	Kit 26 Smart*	88 974 085	100 $\Rightarrow$ 240 V $\sim$	16	8 relays 8 A and 2 relays 5 A				14
<b>Compact versions</b>									
 With display	CD12 Smart*	88 974 041	24 V $\overline{\text{---}}$	8 (4 configurable as analog)	4 relays 8 A	•		•	15
	CD12 Smart*	88 974 043	100 $\Rightarrow$ 240 V $\sim$	8	4 relays 8 A		•		15
	CD20 Smart*	88 974 051	24 V $\overline{\text{---}}$	12 (6 configurable as analog)	8 relays 8 A	•		•	15
	CD20 Smart*	88 974 053	100 $\Rightarrow$ 240 V $\sim$	12	8 relays 8 A		•		15
 Without display	CB12 Smart*	88 974 021	24 V $\overline{\text{---}}$	8 (4 configurable as analog)	4 relays 8 A	•		•	16
	CB12 Smart*	88 974 023	100 $\Rightarrow$ 240 V $\sim$	8	4 relays 8 A		•		16
	CB20 Smart*	88 974 031	24 V $\overline{\text{---}}$	12 (6 configurable as analog)	8 relays 8 A			•	16
	CB20 Smart*	88 974 033	100 $\Rightarrow$ 240 V $\sim$	12	8 relays 8 A		•		16
<b>Expandable versions</b>									
 With display	XD10 Smart*	88 974 141	24 V $\overline{\text{---}}$	6 (4 configurable as analog)	4 relays 8 A	•		•	17
	XD10 Smart*	88 974 143	100 $\Rightarrow$ 240 V $\sim$	6	4 relays 8 A		•		17
	XD26 Smart*	88 974 161	24 V $\overline{\text{---}}$	16 (6 configurable as analog)	8 relays 8 A and 2 relays 5 A	•		•	17
	XD26 Smart*	88 974 163	100 $\Rightarrow$ 240 V $\sim$	16	8 relays 8 A and 2 relays 5 A		•		17
 Without display	XB10 Smart*	88 974 131	24 V $\overline{\text{---}}$	6 (4 configurable as analog)	4 relays 8 A	•		•	18
	XB10 Smart*	88 974 133	100 $\Rightarrow$ 240 V $\sim$	6	4 relays 8 A		•		18
	XB26 Smart*	88 974 151	24 V $\overline{\text{---}}$	16 (6 configurable as analog)	8 relays 8 A and 2 relays 5 A	•		•	18
	XB26 Smart*	88 974 153	100 $\Rightarrow$ 240 V $\sim$	16	8 relays 8 A and 2 relays 5 A		•		18
<b>With Removable Terminal Blocks</b>									
	CD12 RBT Smart*	88 974 441	24 V $\overline{\text{---}}$	8 (4 configurable as analog)	4 relays 8 A				19
	XD26 RBT Smart*	88 974 561	24 V $\overline{\text{---}}$	16 (6 configurable as analog)	8 relays 8 A and 2 relays 5 A				19
<b>Sandwich extensions</b>									
 Communication	XN05 Modbus TCP/IP	88 970 270	24 V $\overline{\text{---}}$					•	23
	XN06 Modbus RS485	88 972 250	24 V $\overline{\text{---}}$					•	23
	XN07 Master RS485	88 974 250	24 V $\overline{\text{---}}$						24
 Digital	XE10	88 970 321	24 V $\overline{\text{---}}$	6	4 relays 5 A			•	26
	XE10	88 970 323	100 $\Rightarrow$ 240 V $\sim$	6	4 relays 5 A		•		26
<b>Termination Extensions</b>									
 Digital	XR06	88 970 211	24 V $\overline{\text{---}}$	4	2 relays 8 A	•		•	26
	XR06	88 970 213	100 $\Rightarrow$ 240 V $\sim$	4	2 relays 8 A		•		26
	XR10	88 970 221	24 V $\overline{\text{---}}$	6	4 relays 8 A	•		•	26
	XR10	88 970 223	100 $\Rightarrow$ 240 V $\sim$	6	4 relays 8 A		•		26
	XR14	88 970 231	24 V $\overline{\text{---}}$	8	4 relays 8 A and 2 relays 5 A	•		•	26
	XR14	88 970 233	100 $\Rightarrow$ 240 V $\sim$	8	4 relays 8 A and 2 relays 5 A		•		26
 Analog	XA03 3xPt100	88 970 800	24 V $\overline{\text{---}}$	3 analog (Pt100)					27
	XA04 2AI/2AO	88 970 241	24 V $\overline{\text{---}}$	2 analog 0-10V/0-20mA (1 Pt100)	2 analog 0-10V/PWM			•	28
<b>Bare board and resin board versions</b>									
 Bare board	NB12	88 970 001	24 V $\overline{\text{---}}$	8 (4 configurable as analog)	4 relays 8 A	•			35
	NB12	88 970 003	100 $\Rightarrow$ 240 V $\sim$	8	4 relays 8 A				35
	NB20	88 970 011	24 V $\overline{\text{---}}$	12 (6 configurable as analog)	8 relays 8 A				35
	NB20	88 970 013	100 $\Rightarrow$ 240 V $\sim$	12	8 relays 8 A				35
 Resin board	NBR12	88 973 001	24 V $\overline{\text{---}}$	8 (4 configurable as analog)	4 relays 8 A	•		•	36
	NBR26	88 973 061	24 V $\overline{\text{---}}$	16 (6 configurable as analog)	10 relays 8 A	•		•	36
	NBR32	88 973 211	24 V $\overline{\text{---}}$	20 (6 configurable as analog)	12 relays 8 A	•			36
	NBR40	88 973 231	24 V $\overline{\text{---}}$	24 (6 configurable as analog)	16 relays 8 A	•			36

\* Millenium 3 Smart: backlit blue LCD display. Extended operating temperature range and function block library



\*\*Millenium 3 Essential (p. 21): Logic Controller with green screen and industrial temperature range

# Millenium 3 accessories

## Power supplies and DC/DC converters in modular casings

	Part number	Input voltage	Output voltage	Nominal power	Output current	Page
	88 950 303	100 ⇒ 240 V ~	24 V ---	7.5 W	0.3 A	44
	88 950 304	100 ⇒ 240 V ~	24 V ---	15 W	0.6 A	
	88 950 307	100 ⇒ 240 V ~	24 V ---	30 W	1.2 A	
	88 950 302	100 ⇒ 240 V ~	24 V ---	60 W	2.5 A	
	88 950 305	100 ⇒ 240 V ~	5 V ---	20 W	4 A	
	88 950 306	100 ⇒ 240 V ~	12 V ---	24 W	2 A	
	88 950 320	9.2 ⇒ 18 V ---	12 V ---	10 W	0.8 A	46
88 950 321	9.2 ⇒ 36 V ---	24 V ---	6 ⇒ 10 W	0.4 A		

## Connection accessories, tools and programming software

	Part number	Name	Page
	88 970 111	M3 Soft: Millenium 3 programming software (CD-ROM)	47
	88 970 108	Memory cartridge for transfer and saving of programmes	
	88 970 102	3 m serial programming cable: PC DB9 F ⇒ Millenium 3	
	88 970 104	Millenium 3 ⇒ Bluetooth® interface (class A 10 m)	
	88 970 109	3 m USB programming cable: PC ⇒ Millenium 3	
	88 970 110	Bluetooth® adaptor ⇒ USB (class A 10 m)	
	88 970 123	1.80 m serial link cable: DB9 M/DB9 F	
	88 970 510	0.5 m serial programming cable: Millenium 3 ⇒ DB9 M	
	88 974 106	Ready to use Millenium 3 Smart democase including: - a CD12 Smart, a CTN probe, a LDR probe, an I/O simulator - a 3 m USB programming cable: PC ⇒ Millenium 3, a M3 Soft CD - a power supply 110 V-230 V ~	14

	Name	Page
<b>Millenium 3 Virtual Display</b>		
	Android smartphone and tablet as well as Windows XP/7 PC application	48

	Name	Page
<b>Man/Machine interface</b>		
	TFT-LCD compact 4.3" and 7" resistive touch panels - MTP6/50, MTP8/50 & MTP8/70	49
	Plug & Play remote LCD displays/keypads	52
	Remote LED display - Input 0-10 V	54

	Name	Page
<b>Remote control communication solutions</b>		
	Modem communication solutions M3MOD, GSM Modem and STN Modem	55

	Name	Page
<b>Temperature probes and light sensors</b>		
	NTC Temperature probes	57
	LDR Light sensors	59
	0-10 V Temperature sensors	60
	Temperature probes Pt100 & Thermocouple	62

	Name	Page
<b>Temperature and signal converters</b>		
	Thermocouple Pt100/Pt1000 ⇒ 0-10 V	64
	PWM to 0-10 V/4-20 mA to 0-10 V	65

	Name	Page
<b>Other accessories and kits</b>		
	Standard Smart and Essential product kits	14
	Removable connectors	47
	Potentiometer ø 22 mm	66
	Faceplates	67

# Millenium 3

## → Smart range starter kits

■ Each standard kit includes:

- 1 Millenium 3 Smart (CD12, CD20 or XD26)
- 1 USB programming cable: PC → Millenium 3
- 1 interactive CD ROM including the software workshop, application library and technical brochures, the library of specific functions



### Part numbers

Type	Input	Output	Supply	Code
Kit 12	8 digital (including 4 analog)	4 relays 8 A	24 V $\overline{\text{DC}}$	<b>88974080</b>
	8 digital	4 relays 8 A	100 → 240 V $\sim$	<b>88974081</b>
Kit 20	12 digital (including 6 analog)	8 relays 8 A	24 V $\overline{\text{DC}}$	<b>88974082</b>
	12 digital	8 relays 8 A	100 → 240 V $\sim$	<b>88974083</b>
Kit 26	16 digital (including 6 analog)	10 relays (8 x 8 A relay and 2 x 5 A relay)	24 V $\overline{\text{DC}}$	<b>88974084</b>
	16 digital	10 relays (8 x 8 A relay and 2 x 5 A relay)	100 → 240 V $\sim$	<b>88974085</b>

## → Standard Smart and Essential product kits

### Part numbers

Type	Description	Code
Kit 16	XD10 Essential - 24 V $\overline{\text{DC}}$ (Ref. 88970141) + XN05 (Ref. 88970270) + 1 Power supply PS24-30 W (Ref. 88950307)	<b>88970825</b>
Kit 20	CD20 Essential - 24 V $\overline{\text{DC}}$ (Ref. 88970051) + 1 Power supply PS24-60 W (Ref. 88950302)	<b>88970808</b>
Kit 26	XD26 Smart - 24 V $\overline{\text{DC}}$ (Ref. 88974161) + M3 Soft (Ref. 88970111) + Power supply PS24-30W (Ref. 88950307) + USB programming cable (Ref. 88970109)	<b>88970094</b>
Kit 32	XD26 Essential - 24 V $\overline{\text{DC}}$ (Ref. 88970161) + XR06 (Ref. 88970211) + 1 Power supply PS24-60 W (Ref. 88950302)	<b>88970813</b>

## → Democase Millenium 3 Smart

- Quickly demonstrates the strengths of Millenium 3 Smart
- Rapid Start Up of the Millenium 3
- Useful for training and demonstrations
- Shipped with a demonstration program installed



### Part numbers

Type	Description	Code
DEMO	Democase Millenium 3 Smart	<b>88974106</b>

### Comments

- The democase consists of:
- 88974042: CD12 Smart: 8xDI (incl. 4xAI) 4xDO 0.5A 24 V  $\overline{\text{DC}}$  (incl. 1 PWM)
  - 89750180 NTC1 probe: 10 KOhm @ 25°C, -25 → +85 °C (FB: CTN1)
  - 89750183: LDR1 probe: 10 → 3000 Lux
  - 88970109: USB 3 m cable
  - 88970111: M3 Soft (CD-ROM)
  - Input Output Simulator (Switches, Potentiometer, LED)
  - Power supply 110V -230 V  $\sim$  with Europe & US adaptor
  - Demonstration program factory installed

# Millenium 3 Smart

## → Smart "Compact" range with display

- Highly visible blue LCD with 4 lines of 18 characters and configurable backlighting
- Allow the use of the entire library of specific functions blocs of the software workshop
- Extended temperature range (-20 °C → +70 °C)
- Analog inputs 0-10 VDC, Potentiometer, NTC, LDR (0-20 mA/Pt100 with converters)
- Selective parameter setting: you can choose the parameters that can be adjusted on the front panel



CD12



CD20

### Part numbers

Type	Input	Output	Supply	Code
CD12 Smart	8 digital (including 4 analog)	4 relays 8 A	24 V ---	88974041
	8 digital (including 4 analog)	4 solid state 0.5 A (including 1 PWM)	24 V ---	88974042
	8 digital	4 relays 8 A	100 → 240 V ~	88974043
	8 digital	4 relays 8 A	24 V ~	88974044
	8 digital (including 4 analog)	4 relays 8 A	12 V ---	88974045
	8 digital (including 4 analog)	4 solid state 0.5 A (including 1 PWM)	12 V ---	88974046
CD20 Smart	12 digital (including 6 analog)	8 relays 8 A	24 V ---	88974051
	12 digital (including 6 analog)	8 solid state 0.5 A (including 4 PWM)	24 V ---	88974052
	12 digital	8 relays 8 A	100 → 240 V ~	88974053
	12 digital	8 relays 8 A	24 V ~	88974054
	12 digital (including 6 analog)	8 relays 8 A	12 V ---	88974055

### Accessories

Type	Description	Code
M3 Soft	Multilingual programming software containing specific library functions (CD-ROM)	88970111
PA	EEPROM memory cartridge	88970108
PA	3 m serial programming cable: PC → Millenium 3	88970102
PA	USB programming cable 3 m: PC → Millenium 3	88970109
PA	Millenium 3 interface → Bluetooth® (class A 10 m)	88970104

### Specific characteristics\*

Operating temperature	-20 → +70 °C
Operating factor	100 % (6 A relays) 66 % (8 A relays)
Storage temperature	-40 → +80 °C
LCD display	Display with 4 lines of 18 characters, white characters on a blue background

### Dimensions (mm)

#### CD12 Smart

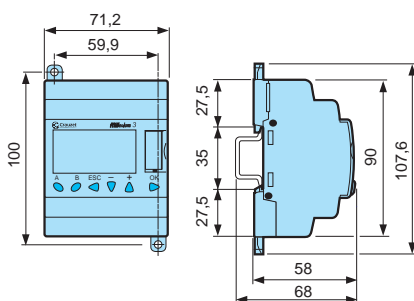

#### CD20 Smart

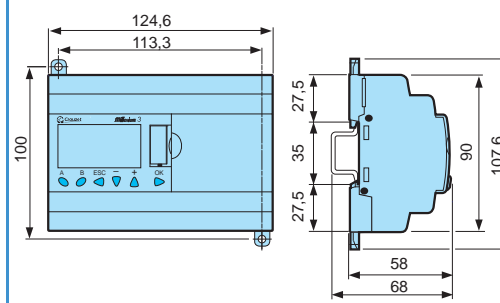

\*Also see Millenium 3 Smart and Essential General characteristics

# Millenium 3 Smart

## → Smart "Compact" range without display

- Efficient and economical version, without display or keys setting
- Allow the use of the entire library of specific functions blocs of the software workshop
- Extended temperature range (-30 °C → +70 °C)
- Analog inputs 0-10 VDC, Potentiometer, NTC, LDR (0-20 mA/Pt100 with converters)



CB12



CB20

### Part numbers

Type	Input	Output	Supply	Code
CB12 Smart	8 digital (including 4 analog)	4 relays 8 A	24 V $\overline{\text{---}}$	88974021
	8 digital	4 relays 8 A	100 → 240 V $\sim$	88974023
	8 digital	4 relays 8 A	24 V $\sim$	88974024
	8 digital (including 4 analog)	4 solid state 0.5 A (including 1 PWM)	12 V $\overline{\text{---}}$	88974026
CB20 Smart	12 digital (including 6 analog)	8 relays 8 A	24 V $\overline{\text{---}}$	88974031
	12 digital	8 relays 8 A	100 → 240 V $\sim$	88974033
	12 digital	8 relays 8 A	24 V $\sim$	88974034

### Accessories

Type	Description	Code
M3 Soft	Multilingual programming software containing specific library functions (CD-ROM)	88970111
PA	EEPROM memory cartridge	88970108
PA	3 m serial programming cable: PC → Millenium 3	88970102
PA	USB programming cable 3 m: PC → Millenium 3	88970109
PA	Millenium 3 interface → Bluetooth® (class A 10 m)	88970104

### Specific characteristics\*

Operating temperature	-30 → +70 °C ( $\overline{\text{---}}$ ); -20 → +70 °C ( $\sim$ )
Operating factor	100 % (6 A relays) 66 % (8 A relays)
Storage temperature	-40 → +80 °C

### Dimensions (mm)

CB12 Smart

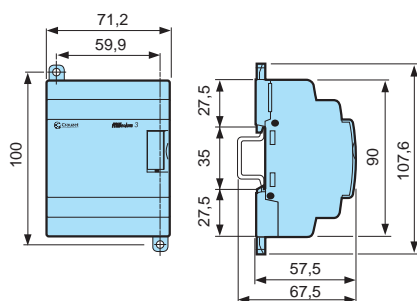

CB20 Smart

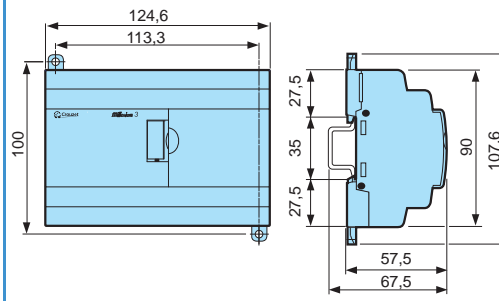

\*Also see Millenium 3 Smart and Essential General characteristics



# Millenium 3 Smart

## → Smart "Expandable" range with display

- Highly visible blue LCD with 4 lines of 18 characters and configurable backlighting
- Allow the use of the entire library of specific functions blocs of the software workshop
- Extended temperature range (-20 °C → +70 °C)
- Analog inputs 0-10 VDC, Potentiometer, NTC, LDR (0-20 mA/Pt100 with converters)
- Open to XN network communication extensions, digital I/O, analog, Pt100 extensions



XD10



XD26

### Part numbers

Type	Input	Output	Supply	Code
XD10 Smart	6 digital (including 4 analog)	4 relays 8 A	24 V ---	88974141
	6 digital (including 4 analog)	4 solid state 0.5 A (including 1 PWM)	24 V ---	88974142
	6 digital	4 relays 8 A	100 → 240 V ~	88974143
	6 digital	4 relays 8 A	24 V ~	88974144
XD26 Smart	16 digital (including 6 analog)	10 relays (8 x 8 A relay and 2 x 5 A relay)	24 V ---	88974161
	16 digital (including 6 analog)	10 solid state 0.5 A (including 4 PWM)	24 V ---	88974162
	16 digital	10 relays (8 x 8 A relay and 2 x 5 A relay)	100 → 240 V ~	88974163
	16 digital	10 relays (8 x 8 A relay and 2 x 5 A relay)	24 V ~	88974164
	16 digital (including 6 analog)	10 relays (8 x 8 A relay and 2 x 5 A relay)	12 V ---	88974165
	16 digital (including 6 analog)	10 solid state 0.5 A (including 4 PWM)	12 V ---	88974166

### Accessories

Type	Description	Code
M3 Soft	Multilingual programming software containing specific library functions (CD-ROM)	88970111
PA	EEPROM memory cartridge	88970108
PA	3 m serial programming cable: PC → Millenium 3	88970102
PA	Serial programming cable 3 m: PC → Millenium 3	88970109
PA	Millenium 3 interface → Bluetooth® (class A 10 m)	88970104

### Specific characteristics\*

Operating temperature	-20 → +70 °C
Operating factor	100 % (6 A relays) 66 % (8 A relays)
Storage temperature	-40 → +80 °C
LCD display	Display with 4 lines of 18 characters, white characters on a blue background

### Dimensions (mm)

#### XD10 Smart

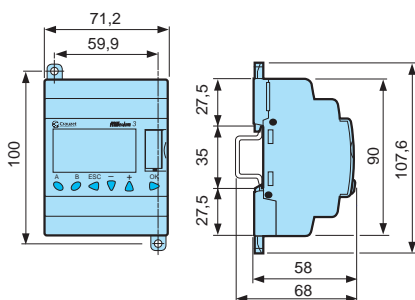

#### XD26 Smart

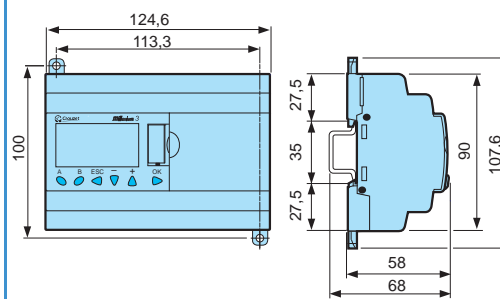

\*Also see Millenium 3 Smart and Essential General characteristics

# Millenium 3 Smart

## → Smart "Expandable" range without display

- Efficient and economical version, without display or keys setting
- Allow the use of the entire library of specific functions blocs of the software workshop
- Extended temperature range (-30 °C → +70 °C)
- Analog inputs 0-10 VDC, Potentiometer, NTC, LDR (0-20 mA/Pt100 with converters)
- Open to XN network communication extensions, digital I/O, analog, Pt100 extensions



XB10



XB26

### Part numbers

Type	Input	Output	Supply	Code
XB10 Smart	6 digital (including 4 analog)	4 relays 8 A	24 V $\overline{\text{---}}$	88974131
	6 digital (including 4 analog)	4 solid state 0.5 A (including 1 PWM)	24 V $\overline{\text{---}}$	88974132
	6 digital	4 relays 8 A	100 → 240 V $\sim$	88974133
	6 digital	4 relays 8 A	24 V $\sim$	88974134
XB26 Smart	16 digital (including 6 analog)	10 relays (8 x 8 A relay and 2 x 5 A relay)	24 V $\overline{\text{---}}$	88974151
	16 digital (including 6 analog)	10 solid state 0.5 A (including 4 PWM)	24 V $\overline{\text{---}}$	88974152
	16 digital	10 relays (8 x 8 A relay and 2 x 5 A relay)	100 → 240 V $\sim$	88974153
	16 digital	10 relays (8 x 8 A relay and 2 x 5 A relay)	24 V $\sim$	88974154
	16 digital (including 6 analog)	10 relays (8 x 8 A relay and 2 x 5 A relay)	12 V $\overline{\text{---}}$	88974155

### Accessories

Type	Description	Code
M3 Soft	Multilingual programming software containing specific library functions (CD-ROM)	88970111
PA	EEPROM memory cartridge	88970108
PA	3 m serial programming cable: PC → Millenium 3	88970102
PA	USB programing cable 3 m: PC → Millenium 3	88970109
PA	Millenium 3 interface → Bluetooth® (class A 10 m)	88970104

### Specific characteristics\*

Operating temperature	-30 → +70 °C ( $\overline{\text{---}}$ ); -20 → +70 °C ( $\sim$ )
Operating factor	100 % (6 A relays) 66 % (8 A relays)
Storage temperature	-40 → +80 °C

### Dimensions (mm)

XB10 Smart

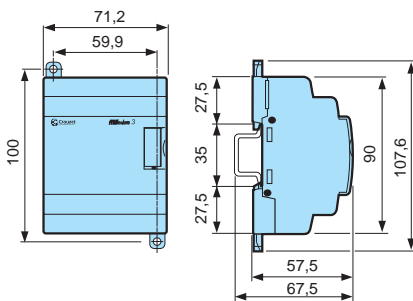

XB26 Smart

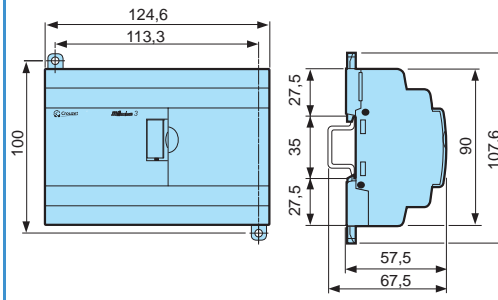

\*Also see Millenium 3 Smart and Essential General characteristics

# Millenium 3 Smart

## → Smart range with Removable Terminal blocks

- Designed for industrial, commercial, medical and paramedical machines
- Faster maintenance process which improves the machine availability rate
- Easier for cabling, allows pre-cabling of the installation
- Simplifies the panel mounting
- Spring cage connectors provide a solution suitable for mobile applications and applications that are subject to vibration
- Compatible with standard 5.08 mm pitch spring cage or screw connectors (angled or straight)
- Features identical to the Millenium 3 Smart range, compatible with any extensions and accessories



CD12 RBT



XD26 RBT

### Part numbers

Type	Designation	Input	Output	Supply	Code
CD12 RBT Smart	Smart Compact with display and removable terminal blocks	8 digital (including 4 analog)	4 relays 8 A	24 V $\overline{\text{---}}$	88974441
XD26 RBT Smart	Smart Expandable with display and removable terminal blocks	16 digital (including 6 analog)	10 relays (8 x 8 A relay and 2 x 5 A relay)	24 V $\overline{\text{---}}$	88974561

### Accessories

Type	Description	Code
M3 Soft	Multilingual programming software containing specific library functions (CD-ROM)	88970111
PA	EEPROM memory cartridge	88970108
PA	3 m serial programming cable: PC → Millenium 3	88970102
PA	USB programming cable 3 m: PC → Millenium 3	88970109
PA	Millenium 3 interface → Bluetooth® (class A 10 m)	88970104
MA	Removable connector (spring cage) kit for NBR12, CD12 RBT	88970313
MA	Removable connector (spring cage) kit for XD26 RBT	88970317

### Dimensions (mm)

CD12 RBT Smart

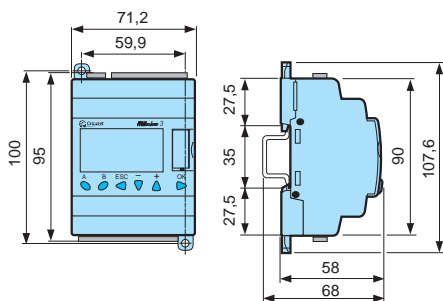

XD26 RBT Smart

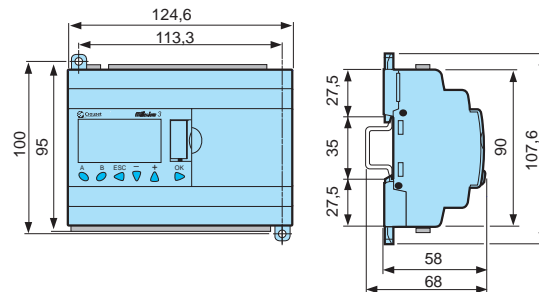

References compatible connectors / Phoenix contact: [www.phoenixcontact.com](http://www.phoenixcontact.com)

## Connectors

Standard Connectors  
with screw connection

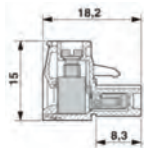

Vertical Connectors  
with screw connection

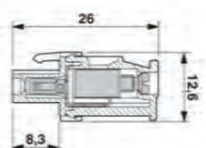

Connectors  
with spring-cage connection

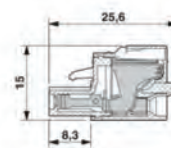

### Maximum current in contacts

10 A @ 70 °C  
12 A @ 60 °C

9 A @ 70 °C  
12 A @ 50 °C

12 A @ 70 °C

### CD12 RBT Smart



Qty	
1	2 pins MSTB 2.5 HC/2-ST-5.08
1	8 pins MSTB 2.5 HC/8-ST-5.08
1	11 pins MSTB 2.5 HC/11-ST-5.08

Qty	
1	2 pins MVSTBR 2.5 HC/2-ST-5.08
1	8 pins MVSTBR 2.5 HC/8-ST-5.08
1	11 pins MVSTBR 2.5 HC/11-ST-5.08

Qty	Ref. Crouzet: 88 970 313
1	2 pins FKC 2.5/2-ST-5.08
1	8 pins FKC 2.5/8-ST-5.08
1	11 pins FKC 2.5/11-ST-5.08

### XD26 RBT Smart



Qty	
1	2 pins MSTB 2.5 HC/2-ST-5.08
1	17 pins MSTB 2.5 HC/17-ST-5.08
3	5 pins MSTB 2.5 HC/5-ST-5.08
1	7 pins MSTB 2.5 HC/7-ST-5.08

Qty	
1	2 pins MVSTBR 2.5 HC/2-ST-5.08
1	17 pins MVSTBR 2.5 HC/17-ST-5.08
3	5 pins MVSTBR 2.5 HC/5-ST-5.08
1	7 pins MVSTBR 2.5 HC/7-ST-5.08

Qty	Ref. Crouzet: 88 970 317
1	2 pins FKC 2.5/2-ST-5.08
1	17 pins FKC 2.5/17-ST-5.08
3	5 pins FKC 2.5/5-ST-5.08
1	7 pins FKC 2.5/7-ST-5.08

## Product adaptations



- Blind versions
- Static outputs versions
- 12 V  $\overline{\text{---}}$ , 24 V  $\sim$  power supply versions (not feasible in 110-230 V  $\sim$  for safety reasons)
- Termination extensions
- UL - cUL certification

# Millenium 3 Essential

## → Essential range: powerful but cost effective

- Industrial temperature range (-20 °C → +55 °C)
- Analog inputs 0-10 VDC, Potentiometer (0-20 mA/Pt100 with converters)
- Display versions:
  - Green LCD with 4 lines of 18 characters and configurable backlighting
  - Selective parameter setting: you can choose the parameters that can be adjusted on the front panel
- Expandable versions: open to XN network communication extensions and digital I/O or analog extensions



CD12/XD10



CD20/XD26



CB12/XB10



CB20/XB26

## Part numbers

### Essential "compact" range

Type	Input	Output	Supply	Code
CD12	8 digital (including 4 analog)	4 relays 8 A	24 V ~	88970041
	8 digital (including 4 analog)	4 solid state 0.5 A (including 1 PWM)	24 V ~	88970042
	8 digital (including 4 analog)	4 relays 8 A	12 V ~	88970045
	8 digital (including 4 analog)	4 solid state 0.5 A (including 1 PWM)	12 V ~	88970865
CD20	12 digital (including 6 analog)	8 relays 8 A	24 V ~	88970051
	12 digital (including 6 analog)	8 solid state 0.5 A (including 4 PWM)	24 V ~	88970052
	12 digital (including 6 analog)	8 relays 8 A	12 V ~	88970055
CB12	8 digital (including 4 analog)	4 relays 8 A	24 V ~	88970021
	8 digital (including 4 analog)	4 solid state 0.5 A (including 1 PWM)	12 V ~	88970840
CB20	12 digital (including 6 analog)	8 relays 8 A	24 V ~	88970031
	12 digital (including 6 analog)	8 solid state 0.5 A (including 4 PWM)	24 V ~	88970806

### Essential "expandable" range

Type	Input	Output	Supply	Code
XD10	6 digital (including 4 analog)	4 relays 8 A	24 V ~	88970141
	6 digital (including 4 analog)	4 solid state 0.5 A (including 1 PWM)	24 V ~	88970142
XD26	16 digital (including 6 analog)	10 relays (8 x 8 A relay and 2 x 5 A relay)	24 V ~	88970161
	16 digital (including 6 analog)	10 solid state 0.5 A (including 4 PWM)	24 V ~	88970162
	16 digital (including 6 analog)	10 relays (8 x 8 A relay and 2 x 5 A relay)	12 V ~	88970165
	16 digital (including 6 analog)	10 solid state 0.5 A (including 4 PWM)	12 V ~	88970814
XB10	6 digital (including 4 analog)	4 relays 8 A	24 V ~	88970131
	6 digital (including 4 analog)	4 solid state 0.5 A (including 1 PWM)	24 V ~	88970132
XB26	16 digital (including 6 analog)	10 relays (8 x 8 A relay and 2 x 5 A relay)	24 V ~	88970151
	16 digital (including 6 analog)	10 solid state 0.5 A (including 4 PWM)	24 V ~	88970152
	16 digital (including 6 analog)	10 relays (8 x 8 A relay and 2 x 5 A relay)	12 V ~	88970155

## Accessories

Type	Description	Code
M3 Soft	Multilingual programming software containing specific library functions (CD-ROM)	88970111
PA	EEPROM memory cartridge	88970108
PA	3 m serial programming cable: PC → Millenium 3	88970102
PA	USB programming cable 3 m: PC → Millenium 3	88970109
PA	Millenium 3 interface → Bluetooth® (class A 10 m)	88970104

## Dimensions (mm)

**CD12**

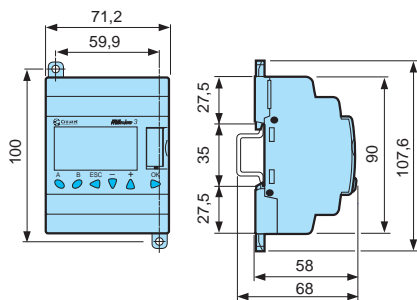

**CB12**

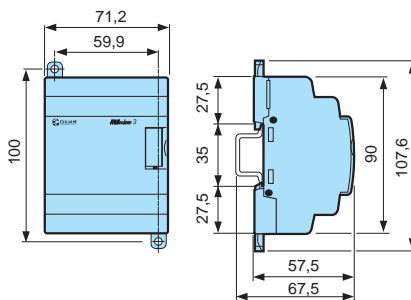

**CD20**

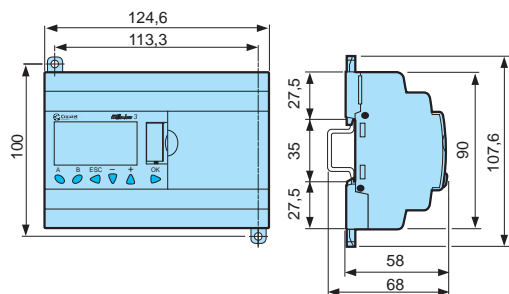

**CB20**

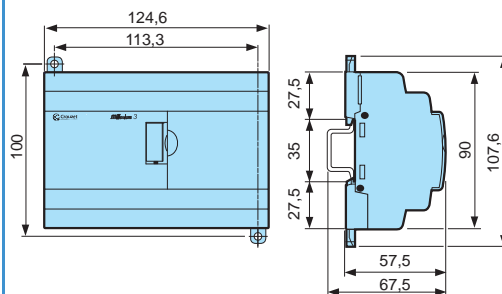

**XD10**

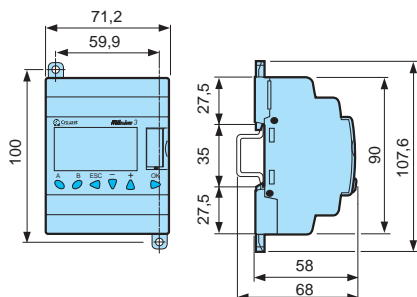

**XB10**

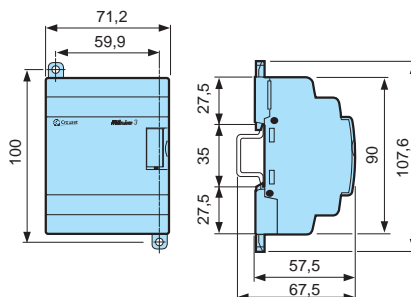

**XD26**

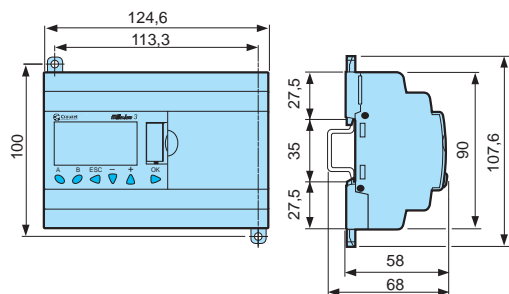

**XB26**

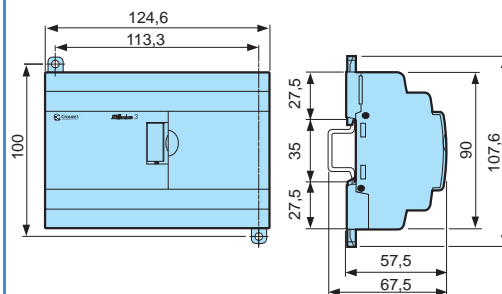

# Millenium 3 Smart and Essential

## → Sandwich communication extensions

- Standard Modbus RS485 or TCP/IP protocol
- Connects one or several Millenium 3 to a touch screen, a supervision PC or a network gateway
- Exchange of the input/output state and/or of internal values
- Updating date and time of a group of Millenium 3
- Power supply via the controller



XN06



XN05

### Part numbers

Type	Description	Supply	Code
XN06	Modbus RS-485 (slave) communication extension	Via the 24 V $\overline{\text{---}}$ controller	<b>88972250</b>
XN05	Ethernet protocol TCP/IP Modbus extension (Server)	Via the 24 V $\overline{\text{---}}$ controller	<b>88970270</b>

Specific characteristics*	88972250	88970270
Certifications	UL, CSA	UL, CSA
Earthing	Yes, refer to the quick reference guide supplied with the product	Yes, refer to the quick reference guide supplied with the product
Operating temperature	-20 → +55 °C (+40 °C in a non-ventilated enclosure) in accordance with IEC/EN 60068-2-1 and IEC/EN 60068-2-2	0 → +55 °C (+40 °C in a non-ventilated enclosure) in accordance with IEC/EN 60068-2-1 and IEC/EN 60068-2-2
Cable length	Maximum length of the network: 1000 m (9600 Baud maxi, AWG 26)	Maximum length between 2 controllers: 100 m

Communication parameters	88972250	88970270
Type of link	2 or 4-wire; RTU or ASCII	-
Transmission rate (Bauds)	1200, 2400, 4800, 9600, 19200, 28800, 38400, 57600	-
Parity	None; even; odd	-
Addressing	1 → 247	Static or dynamic (BootP server)

Characteristics of exchanges	88972250	88970270
------------------------------	----------	----------

Ladder programming	88972250	88970270
Image of smart relay I/O	4	-
Status	1	-

Function blocks programming	88972250	88970270
Read-words	8	8
Read/Write	8	8
Clock words	12	4
"Status" words	1	1

### Dimensions (mm)

XN05 - XN06

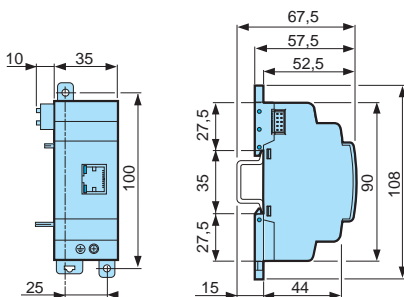

\*Also see Millenium 3 Smart and Essential General characteristics

# Millenium 3 Smart

## → Sandwich communication extension

- Allows the ability to create a Millenium 3 network
- Ability to exchange 6 to 1 words with FBD programming
- Only compatible with Millenium 3 Smart controllers
- Periodic exchanges with max. 6 XN06 extensions
- Automatic recognition of number of slaves



XN07

### Part numbers

Type	Description	Supply	Code
XN07	Master exchange unit for XN06	Via the 24 V $\overline{\text{DC}}$ controller	88974250

### Accessories

Designation	Code
RJ45 tee-joint with 20 cm cable	88970125
EOL ferrules, RC 120 $\Omega$ 1 nF (pack of 2)	88970126
RJ45 wiring kit (2 tees, 2 ferrules, 1 x 4-pair FTP cable, 3 m)	88970127

### Specific characteristics\*

Earthing	Internal link between electronic mass and equipment mass Refer to the quick reference guide supplied with the product
Operating temperature	-20 $\rightarrow$ +55 $^{\circ}\text{C}$ (+40 $^{\circ}\text{C}$ in a non-ventilated enclosure) in accordance with IEC/EN 60068-2-1 and IEC/EN 60068-2-2
Cable length	Maximum network length: 1000 m (max. 9600 bauds, AWG 26)
Pull-up and Pull-down resistance	Polarised line with 470 $\Omega$ resistance (included in product)

### Communication parameters

Type of link	2 or 4-wire; RTU or ASCII
Transmission rate (Bauds)	1200, 2400, 4800, 9600, 19200, 28800, 38400, 57600
Parity	None; even; odd
Addressing	XN07: 7 $\rightarrow$ 247 XN06: 1 $\rightarrow$ 6

### Characteristics of exchanges

Function blocks programming	
Read-words	1 to 6, depending on the number of XN06 (1 XN06: 6 words, 2 XN06: 3 words, 3 XN06: 2 words, 4, 5 or 6 XN06: 1 word)
Write-words	1 to 6, depending on the number of XN06 (1 XN06: 6 words, 2 XN06: 3 words, 3 XN06: 2 words, 4, 5 or 6 XN06: 1 word)
"Status" words	1 (state of XN06, connected - non-connected)
Clock synchronise bit	Date and time update bit XN07 $\rightarrow$ XN06
Initialisation bit	Initialization bit (update of number of slaves connected)
Watch dog bit	1 per XN06 (0/1 if connected)
Cycle time	RTU at 1200 bauds: with 6 XN06: < 3.7 s at 1200 bauds: with 1 XN06: < 1 s at 57600 bauds: with 6 XN06: < 0.2 s  ASCII at 1200 bauds: with 6 XN06: < 5.7 s at 1200 bauds: with 1 XN06: < 1.5 s at 57600 bauds: with 6 XN06: < 0.2 s

\*Also see Millenium 3 Smart and Essential General characteristics



## Dimensions (mm)

XN07

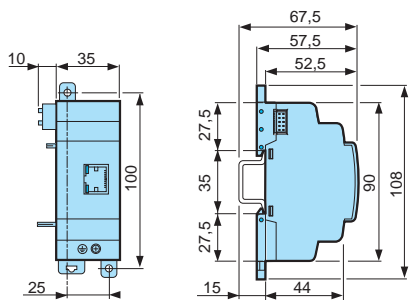

88970125

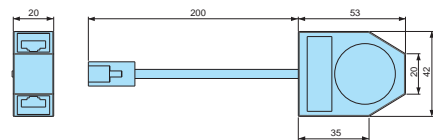

88970126

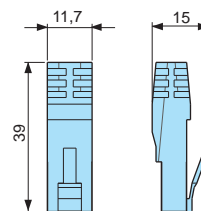

## Connections

Example with three slaves and accessories (two-wire)

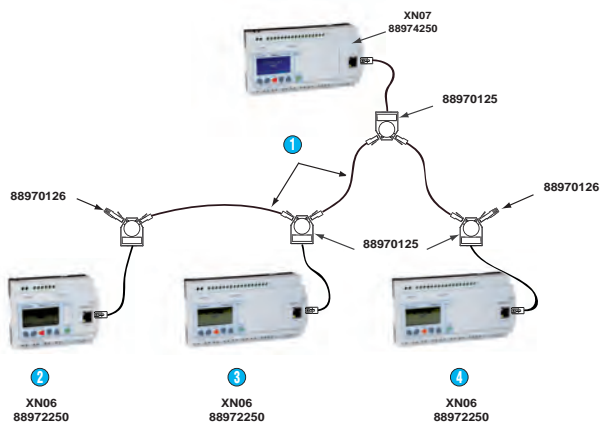

- ① RJ45/RJ45 "Cat 5E" - 100  $\Omega$  FTP, 4 pairs  
(available in RJ45 wiring kit - part no.: 88970127)
- ② XN06 Modbus slave 1
- ③ XN06 Modbus slave 2
- ④ XN06 Modbus slave 3

Concerning connection precautions, please refer to the installation sheet IS 0876  
(M3 Application note - Modbus extension XN06 and XN07: Implementation of simplified networks)

## Applications



### Increase the number of inputs/outputs

- More inputs/outputs while retaining the user-friendly program interface of the Millenium 3
- Easier wiring over long distances (up to 1000 m)
- Flexible, modular solution

### Repartition of an application to several Millenium 3

- Each Millenium 3 manages a part of the application, the Master synchronizes the lot



### Double the processing capacity with data exchange

- Local and/or remote data processing

# Millenium 3 Smart and Essential

## → Digital sandwich extension\*

- Can be used to reach up to 50 inputs/outputs in conjunction with the XR14 termination extension
- Relay outputs one of which is a changeover relay

XE10



### Part numbers

Type	Input	Output	Supply	Code
XE10	6 digital	4 relays 5 A (1 of which is a changeover relay)	Via the 24 V $\overline{\text{DC}}$ controller	<b>88970321</b>
	6 digital	4 relays 5 A (1 of which is a changeover relay)	100 → 240 V $\sim$	<b>88970323</b>
	6 digital	4 relays 5 A (1 of which is a changeover relay)	24 V $\sim$	<b>88970324</b>

### Specific characteristics\*

Certifications CE, UL, CSA

### Dimensions (mm)

XE10

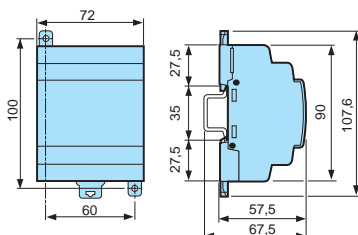

## → Digital extensions\*

- Power supply via the controller at the same voltage as the inputs
- Number of inputs/outputs can be configured in accordance with your requirements



XR06



XR10



XR14

### Part numbers

Type	Input	Output	Supply	Code
XR06	4 digital	2 relays 8 A	Via the 24 V $\overline{\text{DC}}$ controller	<b>88970211</b>
	4 digital	2 relays 8 A	Via the 100 → 240 V $\sim$ controller	<b>88970213</b>
	4 digital	2 relays 8 A	Via the 24 V $\sim$ controller	<b>88970214</b>
	4 digital	2 relays 8 A	Via the 12 V $\overline{\text{DC}}$ controller	<b>88970215</b>
XR10	6 digital	4 relays 8 A	Via the 24 V $\overline{\text{DC}}$ controller	<b>88970221</b>
	6 digital	4 relays 8 A	Via the 100 → 240 V $\sim$ controller	<b>88970223</b>
	6 digital	4 relays 8 A	Via the 24 V $\sim$ controller	<b>88970224</b>
	6 digital	4 relays 8 A	Via the 12 V $\overline{\text{DC}}$ controller	<b>88970225</b>
XR14	8 digital	6 relays (4 x 8 A relay and 2 x 5 A relay)	Via the 24 V $\overline{\text{DC}}$ controller	<b>88970231</b>
	8 digital	6 relays (4 x 8 A relay and 2 x 5 A relay)	Via the 100 → 240 V $\sim$ controller	<b>88970233</b>
	8 digital	6 relays (4 x 8 A relay and 2 x 5 A relay)	Via the 24 V $\sim$ controller	<b>88970234</b>
	8 digital	6 relays (4 x 8 A relay and 2 x 5 A relay)	Via the 12 V $\overline{\text{DC}}$ controller	<b>88970235</b>

### Dimensions (mm)

XR06

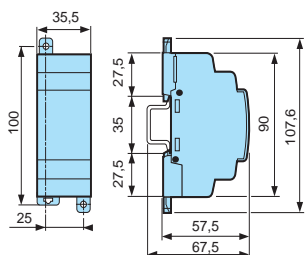

XR10 - XR14

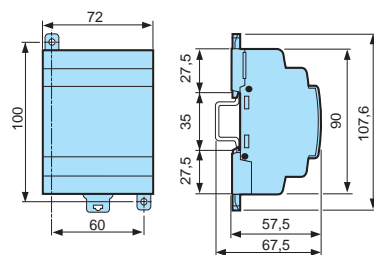

\*Also see Millenium 3 Smart and Essential General characteristics

# Millenium 3 Smart

## → "Application-specific" analog termination extension

- 3 Pt100 temperature inputs in the same casing
- "Application-specific" example: temperature regulation and measurement
- Extension compatible with any Millenium 3 Smart expandable logic controller
- Also see Pt100 probes



XA03

### Part numbers

Type	Input	Supply	Code
XA03	3 Pt100 (-25 → +125 °C)	Via the 24 V $\overline{\text{---}}$ controller	88970800

### Specific characteristics\*

Inputs	Pt100 (IP, IQ, IR)
Certifications	CE, UL, CSA
Conformity to standards	IEC/EN 61131-2 (Zone B), IEC/EN 61000-6-2, IEC/EN 61000-6-3, IEC/EN 61000-6-4
Measurement range	-25 → + 125 °C
Resolution	10 bit
Value of LSB	0.15 °C
Input type	Pt100 probe IEC/EN 60751 3-wire
Conversion time	Module cycle time
Sampling time	< 1 s
Accuracy at 25 °C ambient temperature	± 1 °C
Accuracy at 55 °C ambient temperature	± 1 °C
Cable length	10 m max. with shielded cable

### Dimensions (mm)

XA03

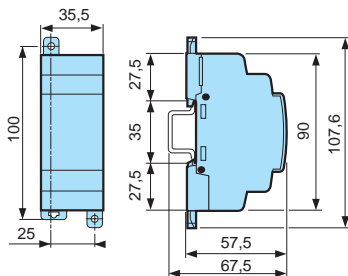

### Product adaptations



- 2 or 3-wire Pt1000 inputs,
- Adjustable temperature range,
- Bare board version,
- Resin casing version,
- Customer labelling.

\*Also see Millenium 3 Smart and Essential General characteristics

# Millenium 3 Smart and Essential

## → Analog extension

- Direct connection of analog 0-10 V or 0-20 mA or Pt100 inputs (10 bit) can be configured using the M3 Soft software
- 2 analog 0-10 V or PWM outputs (10 bit) can be configured using the M3 Soft software
- Ramp can be parameterised for outputs used as 0-10 V outputs
- Power supply via the controller



XA04

### Part numbers

Type	Input	Output	Supply	Code
XA04	1 analog (0-10 V/0-20 mA) 1 analog (0-10 V/0-20 mA/Pt100)	2 analog (0-10 V/PWM)	Via the 24 V $\overline{\text{V}}$ controller	<b>88970241</b>

### Specific characteristics\*

Certifications	IEC/EN 60751
Earthing	Yes, refer to the quick reference guide supplied with the product

### Analog inputs

Inputs used as analog inputs	0-10 V	0-20 mA	Pt100
Inputs	IP and IQ	IP and IQ	IQ
Input range	0 → 10 V $\overline{\text{V}}$	0 → 20 mA	-25 → 125 °C
Input impedance	≥ 18 k $\Omega$	246 $\Omega$	-
Maximum non destructive current/voltage	30 V	30 mA	-
Value of LSB	9.8 mV	20 $\mu$ A	0.15 °C
Input type	Common mode	Common mode	Pt100 probe - IEC 751 - 3-wire
Resolution	10 bit	10 bit	10 bit
Conversion time	Module cycle time	Module cycle time	Module cycle time
Accuracy at 25 °C	± 2 %	± 2 %	± 1.5 °C
Accuracy at 55 °C	± 2 %	± 2 %	± 1.5 °C
Isolation between analog channel and power supply	None	None	None
Cable length	10 m maximum, with shielded cable (sensor not isolated)	10 m maximum, with shielded cable (sensor not isolated)	10 m maximum, with shielded cable (sensor not isolated)
Protection against polarity inversions	Command ignored	Command ignored	Command ignored

### Analog outputs

Range output	0 → 10 V
Input type	Resistive
Max. load	10 mA
Value of LSB	10 mV
Resolution	10 bit
Conversion time	Controller cycle time
Accuracy at 25 °C	±1 % of full scale
Accuracy at 55 °C	±1 % of full scale
Repeat accuracy at 55 °C	± 1 %
Isolation between analog channel and power supply	None
Cable length	10 metres maximum, with shielded cable (sensor not isolated)
Protection against polarity inversions	Yes

### PWM

Range output	V power supply
Max. load	≥ 1.2 k $\Omega$ (I ≤ 20 mA)
PWM cyclic ratio	1024 steps (0 - 100 %)
Frequency	78 Hz, 312.5 Hz, 666.6 Hz, 1000 Hz, 1250 Hz, 1428 Hz, 1666 Hz, 2000 Hz
Accuracy	1 % across the entire temperature range for PWM ratios from 5 % to 95 %
Built-in protections	Against overvoltages: Yes

\*Also see Millenium 3 Smart and Essential General characteristics

## Dimensions (mm)

XA04

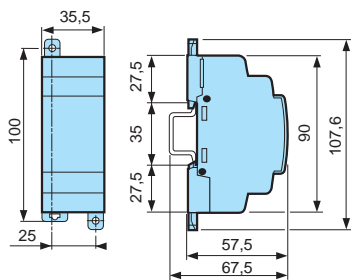

# Millenium 3 Smart and Essential

## → I/O wiring

### Inputs 12 V $\equiv$ , 24 V $\equiv$

**Bases:** CD12, CD20, CB12, CB20, XD10, XD26, XB10, XB26  
**Extensions:** XE10, XR06, XR10, XR14

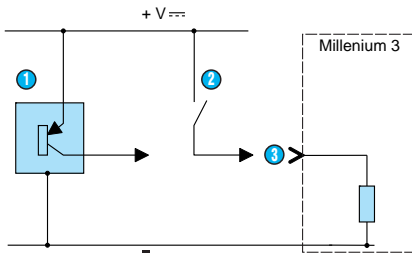

- ① 3-wire PNP sensor
- ② Contact
- ③ Digital input

**Bases:** CD12, CD20, CB12, CB20, XD10, XD26, XB10, XB26

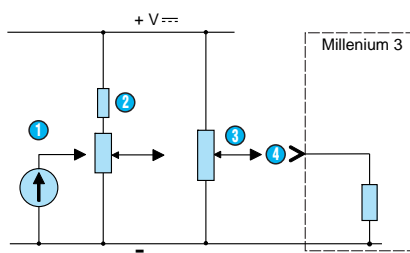

- ① 0-10 V (input set to 0-10 V)
- ② Potentiometer type mounting (input set to 0-10 V)
- ③ Potentiometer (input set as a potentiometer)
- ④ Analog input

**Bases:** CD12, CD20, CB12, CB20, XD10, XD26, XB10, XB26

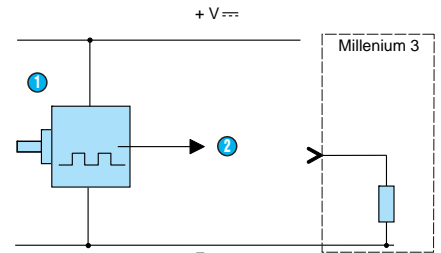

- ① Encoder
- ② High-speed digital input

### Inputs 100-240 V $\sim$ , 24 V $\sim$

**Bases:** CD12, CD20, CB12, CB20, XD10, XD26, XB10, XB26  
**Extensions:** XE10, XR06, XR10, XR14

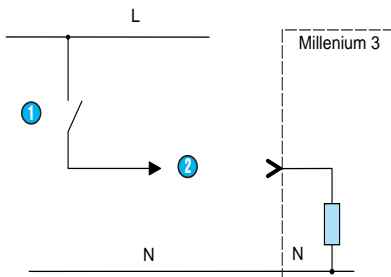

- ① Contact
- ② Digital input

### Analog inputs

**Extension:** XA04

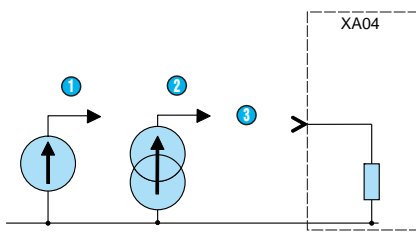

- ① 0-10 V
- ② 0-20 mA
- ③ Analog input

**Extensions:** XA03, XA04

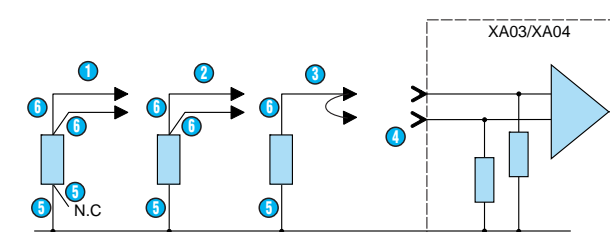

- ① Pt100 4-wire
- ② Pt100 3-wire
- ③ Pt100 2-wire
- ④ Analog inputs
- ⑤ White
- ⑥ Red

# Millenium 3 Smart and Essential

## Relay outputs

**Bases:** CD12, CD20, CB12, CB20, XD10, XD26, XB10, XB26  
**Extensions:** XE10, XR06, XR10, XR14

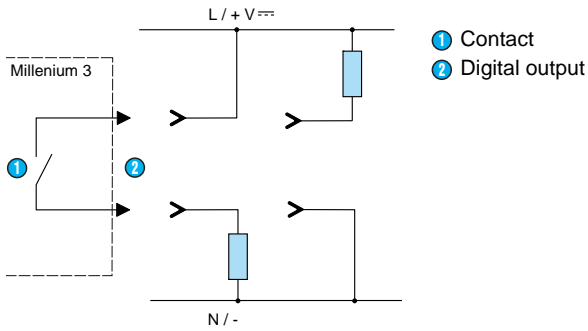

## Solid state outputs

**Bases:** CD12, CD20, CB12, CB20, XD10, XD26, XB10, XB26  
**Extension:** XA04

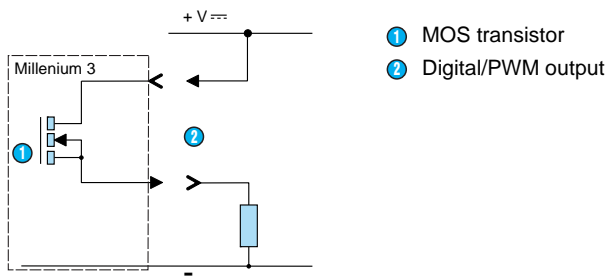

## Analog outputs

**Extension:** XA04

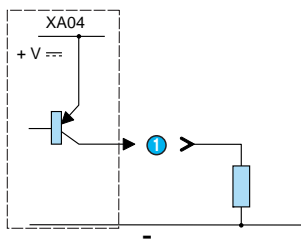

① PWM output

**Extension:** XA04

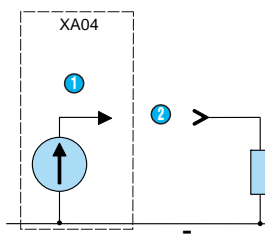

① 0-10 V  
 ② Analog output

# Millenium 3 Smart and Essential

## → Input/output installations: Bases

### "Compact" range: CD12, CD20, CB12, CB20

#### Inputs

##### CD12, CB12

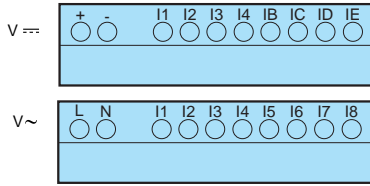

##### CD20, CB20

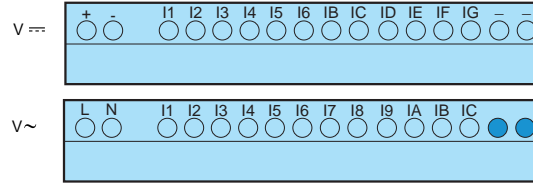

#### Relay outputs

##### CD12, CB12

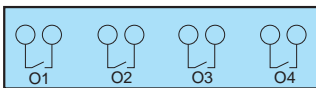

##### CD20, CB20

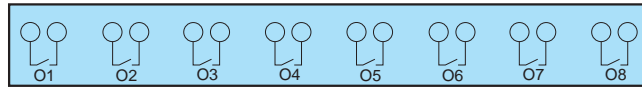

#### Solid state outputs

##### CD12, CB12

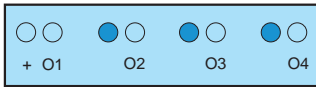

##### CD20

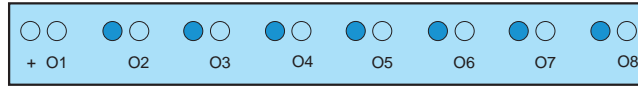

### "Expandable" range: XD10, XD26, XB10, XB26

#### Inputs

##### XD10, XB10

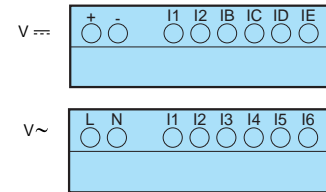

##### XD26, XB26

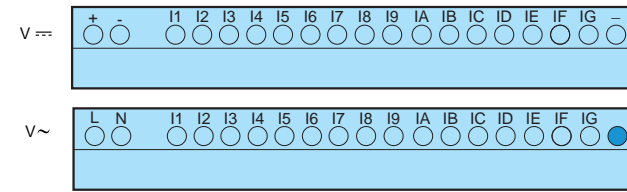

#### Relay outputs

##### XD10, XB10

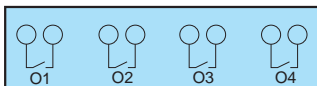

##### XD26, XB26

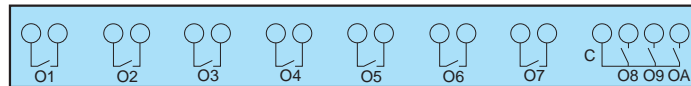

#### Solid state outputs

##### XD10

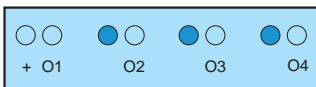

##### XD26

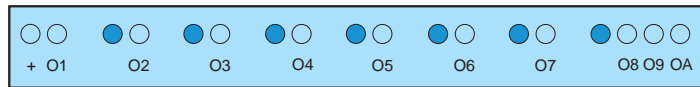



# Millenium 3 Smart and Essential

## → Input/output installations: Extensions

### "Sandwich" communication extensions: XN05, XN06, XN07

XN06, XN07

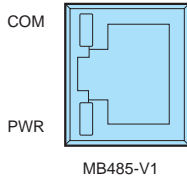

XN05

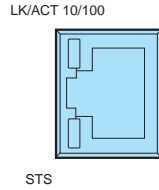

### Digital "Sandwich" extensions: XE10

#### Inputs

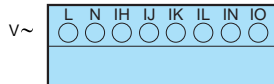
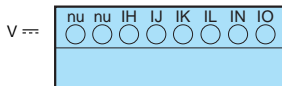

#### Relay outputs

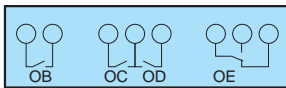

### Digital termination extensions: XR06, XR10, XR14

#### Inputs

XR06

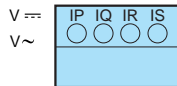

XR10

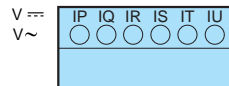

XR14

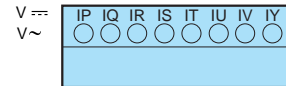

#### Relay outputs

XR06

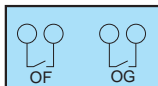

XR10

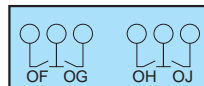

XR14

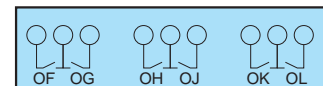

## Analog termination extensions: XA03, XA04

### Inputs

XA03

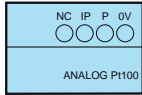

XA04

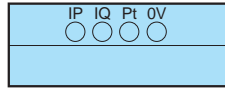

### Outputs

XA03

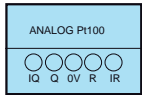

XA04

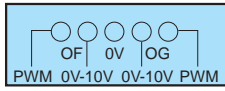

# Millenium 3 Smart

## → Bare board version

- Easy and discreet integration into your applications
- Mass-production applications
- Memory: up to 350 "typical" blocks in FBD language and 120 lines in LADDER language
- Compact dimensions
- Range of controllers for use with application specific functions



NB12



NB20

### Part numbers

Type	Input	Output	Supply	Code
NB12	8 digital (of which 4 are analog)	4 relays	24 V $\equiv$	88970001
	8 digital	4 relays	100 $\rightarrow$ 240 V $\sim$	88970003
	8 digital (of which 4 are analog)	4 relays	12 V $\equiv$	88970005
NB20	12 digital (of which 6 are analog)	8 relays	24 V $\equiv$	88970011
	12 digital	8 relays	100 $\rightarrow$ 240 V $\sim$	88970013
NBxx	In accordance with your requirements	In accordance with your requirements	In accordance with your requirements	•

### Accessories

Type	Description	Code
M3 Soft	Multilingual programming software containing specific library functions (CD-ROM)	88970111
PA	EEPROM memory cartridge	88970108
PA	3 m serial programming cable: PC $\rightarrow$ Millenium 3	88970102
PA	USB programing cable 3 m: PC $\rightarrow$ Millenium 3	88970109
PA	Millenium 3 interface $\rightarrow$ Bluetooth <sup>®</sup> (class A 10 m)	88970104

### Specific characteristics\*

Protection rating IP00

### Dimensions (mm)

NB12

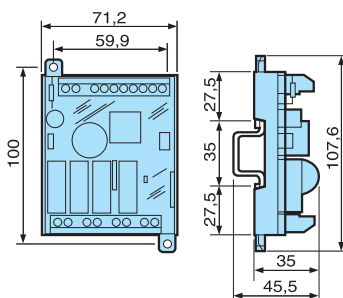

NB20

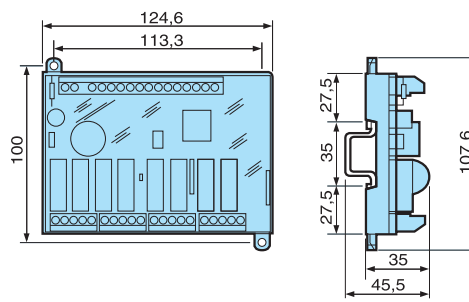

### Product adaptations



- Tropicalization
- Spring connectors or removable connectors
- Changing the number of I/O
- Updating power supply

\*Also see Millenium 3 Smart and Essential General characteristics

# Millenium 3 Smart

## → Resin board version

- Vibration resistant
- Extended temperature range
- Outputs via removable connectors
- IP50 seal (connectors)
- DB 9-pin programming port via standard RS 232 cable
- Designed for application-specific functions
- Supplied without connectors. Connectors available (Ref. 88970313, 88970314, 88970315, 88970316)



NBR12



NBR26



NBRxx

### Part numbers

Type	Designation	Input	Output	Supply	Code
NBR12	Relay outputs with connectors	8 digital (including 4 analog)	4 relays	24 V ---	88973001
	Relay outputs with connectors	8 digital (including 4 analog)	4 solid state 0.5 A (including 1 PWM)	24 V ---	88973002
NBR26	Relay outputs with connectors	16 digital (including 6 analog)	10 relays	24 V ---	88973061
	Relay outputs with connectors	16 digital (including 6 analog)	10 solid state 0.5 A (including 4 PWM)	24 V ---	88973062
NBR32	Relay outputs with connectors	20 digital (including 6 analog)	12 relays	24 V ---	88973211
NBR40	Relay outputs with connectors	24 digital (including 6 analog)	16 relays	24 V ---	88973231
NBRxx	Relay or solid state outputs, connectors or wires	In accordance with your requirements	In accordance with your requirements	In accordance with your requirements	•

### Accessories

Type	Description	Code
M3 Soft	Multilingual programming software containing specific library functions (CD-ROM)	88970111
PA	1.80 m serial link cable: DB9 M/DB9 F	88970123
PA	PC: USB → DB9 (RS 232) link cable	88950105
MA	Removable connector (spring cage) kit for NBR12, CD12 RBT	88970313
MA	Removable connector kit for NBR26	88970314
MA	Removable connector kit for NBR32	88970315
MA	Removable connector kit for NBR40	88970316

### Specific characteristics\*

Certifications	CE
Protection index	IP50 (removable connectors)
Mechanical resistance IEC 61373	Railway applications - Rolling stock Category 1 class B stock mounted on car Vibration resistance: 5-150 Hz Random sampling: 10 minutes in each direction (X, Y, Z) Sinusoidal sampling: 5 hours in each direction (X, Y, Z) Shock resistance: 3 shocks 3 g/30 ms per direction Dropping: Total of 26 drops on all sides from a height of 1 metre
Mechanical resistance GAM EG 13	Terrestrial military vehicles Vibration resistance 5-500 Hz 50 m/s <sup>2</sup> Sinusoidal sampling 5 hours in each direction (X, Y, Z) Shock resistance: Acceleration: 150 m/s <sup>2</sup> , duration: 11 ms, 3 shocks per shaft Acceleration: 300 m/s <sup>2</sup> , duration: 11 ms, 3 shocks per shaft Bumps: 1000 half wave sine mechanical bumps 15 g / 6 ms per axe
Operating temperature	-30 → +70 °C (---)
Storage temperature	-40 → +80 °C
Housing	Self-extinguishing UL94V2
Resin	UL approved Self-extinguishing UL94V0 Semi-rigid polyurethane resin Solid black appearance Breakdown voltage: 25 kV/mn Water absorption: 0.2 % (24 hours at 23 °C) Shore D hardness: 50 ±5 Smoke category: F1
Outputs	Removable connectors
Breaking current	6 A relay output

\*Also see Millenium 3 Smart and Essential General characteristics

## Dimensions (mm)

**NBR12**

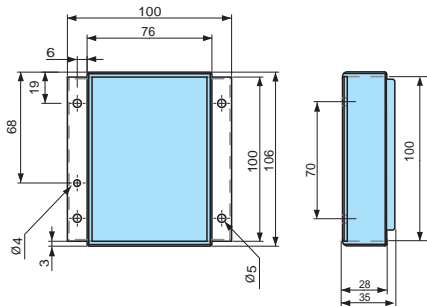

**NBR26**

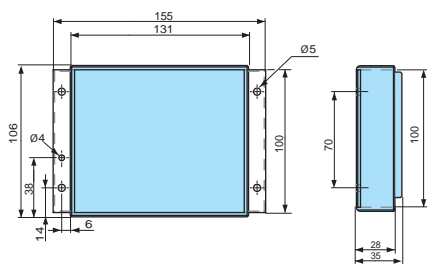

**NBR32**

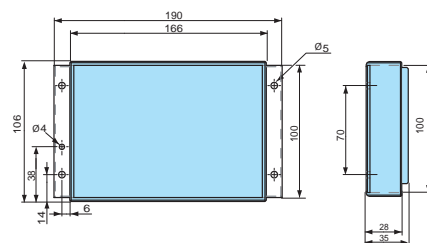

**NBR40**

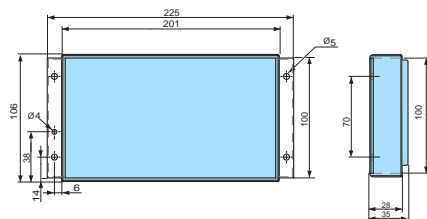

## Product adaptations



- 40 cm wire
- Extended power supply range (9 → 18 V  $\overline{\text{---}}$ ), (16 → 36 V  $\overline{\text{---}}$ )
- Remote polyester keyboard
- UL, CSA, GL certification
- Integration of all available electrical functions in the catalogue (e.g.: Bluetooth<sup>®</sup> module, Pt100 input, 0-20 mA input, 0-10 V power output, etc)
- Changing the number of I/O

# Millenium 3 Smart

## → Input/output installations

Bare boards (NB12, NB20) & resin boards (NBR12, NBR26, NBR32, NBR40)

### Inputs

**NB12, NBR12**

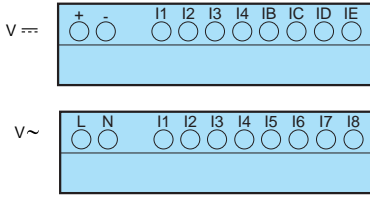

**NB20**

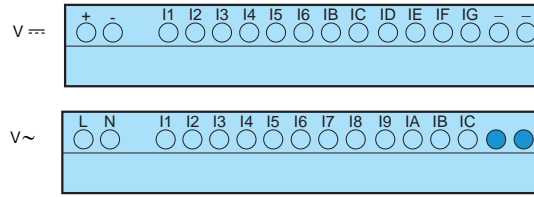

**NBR26**

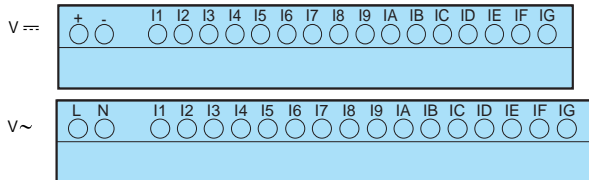

**NBR32**

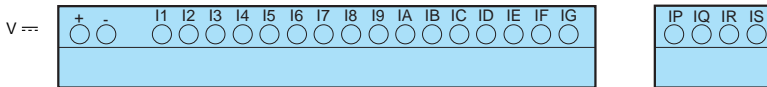

**NBR40**

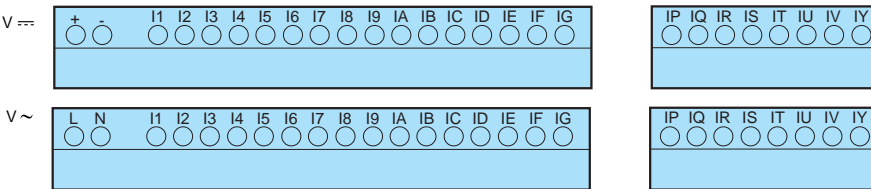

### Relay outputs

**NB12**

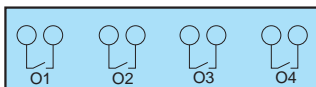

**NBR12**

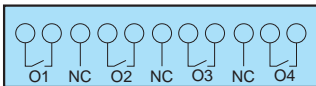

**NB20**

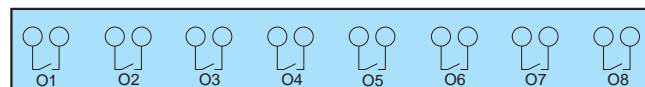

**NBR26**

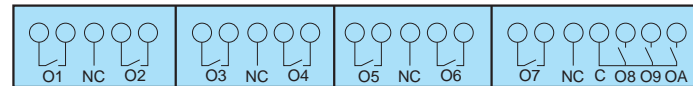

**NBR32**

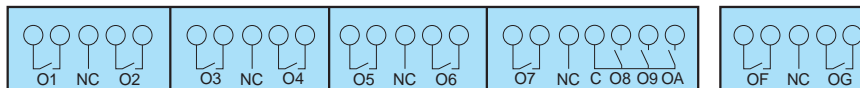

**NBR40**

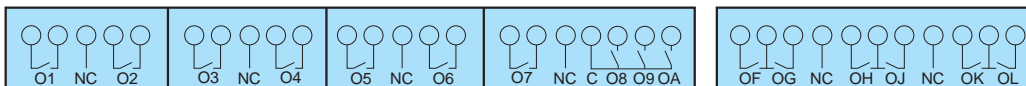

### Solid state outputs

**NB12**

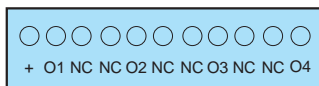

**NBR26**

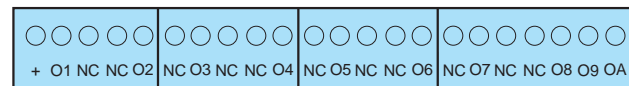

# Millenium 3 Smart and Essential

## → General characteristics

- Millenium 3 compact range
- Millenium 3 expandable range



### General environment characteristics for CB, CD, XD, XB, XR and XE product types

<b>Certifications</b>	CE, UL, CSA, GL
<b>Conformity to standards (with the low voltage directive and EMC directive)</b>	IEC/EN 61131-2 (Open equipment) IEC/EN 61131-2 (Zone B) IEC/EN 61000-6-2 IEC/EN 61000-6-3 (*) IEC/EN 61000-6-4 (*) Except configuration (88 970 1.1 or 88 970 1.2) + (88 970 250 or 88 970 270) + 88 970 241 class A (class B in a metal enclosure)
<b>Earthing</b>	Not included
<b>Protection rating</b>	In accordance with IEC/EN 60529: IP40 on front panel IP20 on terminal block
<b>Overvoltage category</b>	3 in accordance with IEC/EN 60664-1
<b>Pollution</b>	Degree: 2 in accordance with IEC/EN 61131-2
<b>Max operating Altitude</b>	Operation: 2000 m Transport: 3048 m
<b>Mechanical resistance</b>	Immunity to vibrations IEC/EN 60068-2-6, test Fc Immunity to shock IEC/EN 60068-2-27, test Ea
<b>Resistance to electrostatic discharge</b>	Immunity to ESD IEC/EN 61000-4-2, level 3
<b>Resistance to HF interference</b>	Immunity to radiated electrostatic fields IEC/EN 61000-4-3 Immunity to fast transients (burst immunity) IEC/EN 61000-4-4, level 3 Immunity to shock waves IEC/EN 61000-4-5 Radio frequency in common mode IEC/EN 61000-4-6, level 3 Voltage dips and breaks (~) IEC/EN 61000-4-11 Immunity to damped oscillatory waves IEC/EN 61000-4-12
<b>Conducted and radiated emissions</b>	Class B (*) in accordance with EN 55022, EN 55011 (CISPR22, CISPR11) group 1 (*) Except configuration (88 970 1.1 or 88 970 1.2) + (88 970 250 or 88 970 270) + 88 970 241 class A (class B in a metal enclosure)
<b>Operating temperature Millenium 3 Essential and extensions</b>	-20 → +55 °C (+40 °C in a non-ventilated enclosure) in accordance with IEC/EN 60068-2-1 and IEC/EN 60068-2-2
<b>Operating temperature Millenium 3 Smart</b>	-20 → +70 °C except CB and XB versions in V ---: -30 → +70 °C (+40 °C in a non-ventilated enclosure) in accordance with IEC/EN 60068-2-1 and IEC/EN 60068-2-2
<b>Storage temperature Millenium 3 Essential and extensions</b>	-40 → +70 °C in accordance with IEC/EN 60068-2-1 and IEC/EN 60068-2-2
<b>Storage temperature Millenium 3 Smart</b>	-40 → +80 °C in accordance with IEC/EN 60068-2-1 and IEC/EN 60068-2-2
<b>Relative humidity</b>	95 % max. (no condensation or dripping water) in accordance with IEC/EN 60068-2-30
<b>Mounting</b>	On symmetrical DIN rail, 35 x 7.5 mm and 35 x 15 mm, or on panel (2 x Ø 4 mm)
<b>Screw terminals connection capacity</b>	Flexible wire with ferrule = 1 conductor: 0.25 to 2.5 mm <sup>2</sup> (AWG 24 → AWG 14) 2 conductors 0.25 to 0.75 mm <sup>2</sup> (AWG 24 → AWG 18) Semi-rigid wire = 1 conductor: 0.2 to 2.5 mm <sup>2</sup> (AWG 25 → AWG 14) Rigid wire = 1 conductor: 0.2 to 2.5 mm <sup>2</sup> (AWG 25 → AWG 14) 2 conductors 0.2 to 1.5 mm <sup>2</sup> (AWG 25 → AWG 16) Tightening torque = 0.5 N.m (4.5 lb-in) (tighten using screwdriver diam. 3.5 mm)

## Processing characteristics of CB, CD, XD & XB product types

	Millenium 3 Smart and Essential versions XD, XB	Millenium 3 Essential versions CB, CD
Program size function blocks (FBD)	350 typical blocks 64 macros maximum 256 blocks maximum per macro	180 typical blocks 64 macros maximum 256 blocks maximum per macro
Memory size function blocks (FBD)	8 K	4 K
Number of lines in Ladder	120 lines	120 lines
LCD display	CD, XD: Display with 4 lines of 18 characters	
Programming method	Function blocks / SCF (Grafcet) or Ladder	
Program memory	Flash EEPROM	
Removable memory	EEPROM	
Data memory	368 bit/200 words	
Back-up time in the event of power failure	Program and settings in the controller: 10 years Program and settings in the plug-in memory: 10 years Data memory: 10 years	
Cycle time	FBD: 6 → 90 ms (typically 20 ms) Ladder: typically 20 ms	
Response time	Input acquisition time: + 1 to 2 cycle times	
Clock data retention	10 years (lithium battery) at 25 °C	
Clock drift	Drift < 12 min/year (at 25 °C) 6 s/month (at 25 °C with user-definable correction of drift)	
Timer block accuracy	1 % ± 2 cycle times	
Start up time on power up	< 1.2 s	

## Characteristics of products with AC power supplied

Supply	24 V ~	100 → 240 V ~
Nominal voltage	24 V ~	100 → 240 V ~
Operating limits	-15 % / +20 % or 20.4 V ~ → 28.8 V ~	-15 % / +10 % or 85 V ~ → 264 V ~
Supply frequency range	50/60 Hz (+4 % / -6 %) or 47 → 53 Hz / 57 → 63 Hz	50/60 Hz (+4 % / -6 %) or 47 → 53 Hz / 57 → 63 Hz
Immunity from micro power cuts	10 ms (repetition 20 times)	10 ms (repetition 20 times)
Max. absorbed power	CB12-CD12-XD10-XB10: 4 VA CB20-CD20: 6 VA XD10-XB10 with extension: 7.5 VA XD26-XB26: 7.5 VA XD26-XB26 with extension: 10 VA	CB12-CD12-XD10-XB10: 7 VA CB20-CD20: 11 VA XD10-XB10 with extension: 12 VA XD26-XB26: 12 VA XD26-XB26 with extension: 17 VA
Isolation voltage	1780 V ~	1780 V ~
Inputs	24 V ~	100 → 240 V ~
Input voltage	24 V ~ (-15 % / +20 %)	100 → 240 V ~ (-15 % / +10 %)
Input current	4.4 mA @ 20.4 V ~ 5.2 mA @ 24.0 V ~ 6.3 mA @ 28.8 V ~	0.24 mA @ 85 V ~ 0.75 mA @ 264 V ~
Input impedance	4.6 kΩ	350 kΩ
Logic 1 voltage threshold	≥ 14 V ~	≥ 79 V ~
Making current at logic state 1	> 2 mA	> 0.17 mA
Logic 0 voltage threshold	≤ 5 V ~	≤ 20 V ~ (≤ 28 V ~ : XE10, XR06, XR10, XR14)
Release current at logic state 0	< 0.5 mA	< 0.5 mA
Response time with function blocks programming	Configurable in increments of 10 ms 50 ms min. up to 255 ms State 0 → 1 (50/60 Hz)	Configurable in increments of 10 ms 50 ms min. up to 255 ms State 0 → 1 (50/60 Hz)
Response time with Ladder programming	50 ms State 0 → 1 (50/60 Hz)	50 ms State 0 → 1 (50/60 Hz)
Maximum counting frequency	In accordance with cycle time (Tc) and input response time (Tr): $1 / ((2 \times Tc) + Tr)$	In accordance with cycle time (Tc) and input response time (Tr): $1 / ((2 \times Tc) + Tr)$
Sensor type	Contact or 3-wire PNP	Contact or 3-wire PNP
Input type	Resistive	Resistive
Isolation between power supply and inputs	None	None
Isolation between inputs	None	None
Protection against polarity inversions	Yes	Yes
Status indicator	On LCD screen for CD and XD	On LCD screen for CD and XD



### Characteristics of relay outputs common to the entire range

<b>Max. breaking voltage</b>	5 → 30 V $\overline{\text{---}}$ 24 → 250 V $\sim$
<b>Breaking current</b>	CB-CD-XD10-XB10-XR06-XR10: 8 A XD26-XB26: 8 x 8 A relay, 2 x 5 A relay XE10: 4 x 5 A relay XR14: 4 x 8 A relay, 2 x 5 A relay
<b>Electrical durability for 500 000 operating cycles</b>	Utilization category DC-12: 24 V, 1.5 A Utilization category DC-13: 24 V (L/R = 10 ms), 0.6 A Utilization category AC-12: 230 V, 1.5 A Utilization category AC-15: 230 V, 0.9 A
<b>Max. Output Common Current</b>	12 A for O8, O9, OA
<b>Minimum switching capacity</b>	10 mA (at minimum voltage of 12 V)
<b>Minimum load</b>	12 V, 10 mA
<b>Maximum rate</b>	Off load: 10 Hz At operating current: 0.1 Hz
<b>Mechanical life</b>	10.000.000 (operations)
<b>Voltage for withstanding shocks</b>	In accordance with IEC/EN 60947-1 and IEC/EN 60664-1: 4 kV
<b>Response time</b>	Make 10 ms Release 5 ms
<b>Built-in protections</b>	Against short-circuits: None Against overvoltages and overloads: None
<b>Status indicator</b>	On LCD screen for CD and XD

### Characteristics of product with DC power supplied

Supply	12 V $\overline{\text{---}}$	24 V $\overline{\text{---}}$
<b>Nominal voltage</b>	12 V $\overline{\text{---}}$	24 V $\overline{\text{---}}$
<b>Operating limits</b>	-13 % / +20 % or 10.4 V $\overline{\text{---}}$ → 14.4 V $\overline{\text{---}}$ (including ripple)	-20 % / +25 % or 19.2 V $\overline{\text{---}}$ → 30 V $\overline{\text{---}}$ (including ripple)
<b>Immunity from micro power cuts</b>	≤ 1 ms (repetition 20 times)	≤ 1 ms (repetition 20 times)
<b>Max. absorbed power</b>	CB12 with solid state outputs: 1.5 W CD12: 1.5 W CD20: 2.5 W XD26-XB26: 3 W XD26-XB26 with extension: 5 W XD26 with solid state outputs: 2.5 W	CB12-CD12-CD20 with solid state outputs - XD10-XB10 with solid state outputs: 3 W XD10-XB10 with relay outputs: 4 W XD26-XB26 with solid state outputs: 5 W CB20-CD20 with relay outputs: 6 W XD26 with relay outputs: 6 W XD10-XB10 with extension: 8 W XD26-XB26 with extension: 10 W
<b>Protection against polarity inversions</b>	Yes	Yes
Digital inputs (I1 to IA and IH to IY)	12 V $\overline{\text{---}}$	24 V $\overline{\text{---}}$
<b>Input voltage</b>	12 V $\overline{\text{---}}$ (-13 % / +20 %)	24 V $\overline{\text{---}}$ (-20 % / +25 %)
<b>Input current</b>	3.9 mA @ 10.44 V $\overline{\text{---}}$ 4.4 mA @ 12.0 V $\overline{\text{---}}$ 5.3 mA @ 14.4 V $\overline{\text{---}}$	2.6 mA @ 19.2 V $\overline{\text{---}}$ 3.2 mA @ 24 V $\overline{\text{---}}$ 4.0 mA @ 30.0 V $\overline{\text{---}}$
<b>Input impedance</b>	2.7 k $\Omega$	7.4 k $\Omega$
<b>Logic 1 voltage threshold</b>	≥ 7 V $\overline{\text{---}}$	≥ 15 V $\overline{\text{---}}$
<b>Making current at logic state 1</b>	≥ 2 mA	≥ 2.2 mA
<b>Logic 0 voltage threshold</b>	≤ 3 V $\overline{\text{---}}$	≤ 5 V $\overline{\text{---}}$
<b>Release current at logic state 0</b>	< 0.9 mA	< 0.75 mA
<b>Response time</b>	1 → 2 cycle times + 6 ms	1 → 2 cycle times + 6 ms
<b>Maximum counting frequency</b>	- Inputs I1 & I2: FBD (up to 6 kHz) & Ladder (1 kHz) - Inputs I3 to IA & IH to IY: In accordance with cycle time (Tc) and input response time (Tr): $1 / (2 \times Tc) + Tr$	- Inputs I1 & I2: FBD (up to 6 kHz) & Ladder (1 kHz) - Inputs I3 to IA & IH to IY: In accordance with cycle time (Tc) and input response time (Tr): $1 / (2 \times Tc) + Tr$
<b>Sensor type</b>	Contact or 3-wire PNP	Contact or 3-wire PNP
<b>Conforming to IEC/EN 61131-2</b>	Type 1	Type 1
<b>Input type</b>	Resistive	Resistive
<b>Isolation between power supply and inputs</b>	None	None
<b>Isolation between inputs</b>	None	None
<b>Protection against polarity inversions</b>	Yes	Yes
<b>Status indicator</b>	On LCD screen for CD and XD	On LCD screen for CD and XD

Analog or digital inputs (IB to IG)		
	12 V $\overline{\text{---}}$	24 V $\overline{\text{---}}$
CB12-CD12-XD10-XB10	4 inputs IB $\rightarrow$ IE	4 inputs IB $\rightarrow$ IE
CB20-CD20-XB26-XD26	6 inputs IB $\rightarrow$ IG	6 inputs IB $\rightarrow$ IG
Inputs used as analog inputs only in FBD		
Measurement range	(0 $\rightarrow$ 10 V) or (0 $\rightarrow$ V power supply)	(0 $\rightarrow$ 10 V) ou (0 $\rightarrow$ V power supply)
Input impedance	14 k $\Omega$	12 k $\Omega$
Input voltage	14.4 V $\overline{\text{---}}$ max.	30 V $\overline{\text{---}}$ max.
Value of LSB	14 mV	29 mV
Input type	Common mode	Common mode
Resolution	10 bit at max. input voltage	10 bit at max. input voltage
Conversion time	Controller cycle time	Controller cycle time
Accuracy at 25 °C	$\pm$ 5 %	$\pm$ 5 %
Accuracy at 55 °C	$\pm$ 6.2 %	$\pm$ 6.2 %
Repeat accuracy at 55 °C	$\pm$ 2 %	$\pm$ 2 %
Isolation between analog channel and power supply	None	None
Cable length	10 m maximum, with shielded cable (sensor not isolated)	10 m maximum, with shielded cable (sensor not isolated)
Protection against polarity inversions	Yes	Yes
Potentiometer control	2.2 k $\Omega$ / 0.5 W (recommended) 10 k $\Omega$ max.	2.2 k $\Omega$ / 0.5 W (recommended) 10 k $\Omega$ max.
Inputs used as digital inputs		
Input voltage	12 V $\overline{\text{---}}$ (-13 % / +20 %)	24 V $\overline{\text{---}}$ (-20 % / +25 %)
Input current	0.7 mA @ 10.44 V $\overline{\text{---}}$ 0.9 mA @ 12.0 V $\overline{\text{---}}$ 1.0 mA @ 14.4 V $\overline{\text{---}}$	1.6 mA @ 19.2 V $\overline{\text{---}}$ 2.0 mA @ 24.0 V $\overline{\text{---}}$ 2.5 mA @ 30.0 V $\overline{\text{---}}$
Input impedance	14 k $\Omega$	12 k $\Omega$
Logic 1 voltage threshold	$\geq$ 7 V $\overline{\text{---}}$	$\geq$ 15 V $\overline{\text{---}}$
Making current at logic state 1	$\geq$ 0.5 mA	$\geq$ 1.2 mA
Logic 0 voltage threshold	$\leq$ 3 V $\overline{\text{---}}$	$\leq$ 5 V $\overline{\text{---}}$
Release current at logic state 0	$\leq$ 0.2 mA	$\leq$ 0.5 mA
Response time	1 $\rightarrow$ 2 cycle times	1 $\rightarrow$ 2 cycle times
Maximum counting frequency in FBD	In accordance with cycle time (Tc) and input response time (Tr): $1 / (2 \times Tc) + Tr$	In accordance with cycle time (Tc) and input response time (Tr): $1 / (2 \times Tc) + Tr$
Sensor type	Contact or 3-wire PNP	Contact or 3-wire PNP
Conforming to IEC/EN 61131-2	Type 1	Type 1
Input type	Resistive	Resistive
Isolation between power supply and inputs	None	None
Isolation between inputs	None	None
Protection against polarity inversions	Yes	Yes
Status indicator	On LCD screen for CD and XD	On LCD screen for CD and XD
Characteristics of relay outputs common to the entire range		
Max. breaking voltage	5 $\rightarrow$ 30 V $\overline{\text{---}}$ 24 $\rightarrow$ 250 V $\sim$	
Max. Output Common Current	12 A (10 A UL) for O8, O9, OA	
Breaking current	CB-CD-XD10-XB10-XR06-XR10: 8 A XD26-XB26: 8 x 8 A relay, 2 x 5 A relay XE10: 4 x 5 A relay XR14: 4 x 8 A relay, 2 x 5 A relay	
Electrical durability for 500 000 operating cycles	Utilization category DC-12: 24 V, 1.5 A Utilization category DC-13: 24 V (L/R = 10 ms), 0.6 A Utilization category AC-12: 230 V, 1.5 A Utilization category AC-15: 230 V, 0.9 A	
Minimum switching capacity	10 mA (at minimum voltage of 12 V)	
Minimum load	12 V, 10 mA	
Maximum rate	Off load: 10 Hz At operating current: 0.1 Hz	
Mechanical life	10.000.000 (operations)	
Voltage for withstanding shocks	In accordance with IEC/EN 60947-1 and IEC/EN 60664-1: 4 kV	
Off-cycle response time	Make 10 ms Release 5 ms	
Built-in protections	Against short-circuits: None Against overvoltages and overloads: None	
Status indicator	On LCD screen for CD and XD	

Digital / PWM solid state outputs	12 V $\overline{\text{---}}$	24 V $\overline{\text{---}}$
PWM solid state outputs*	CB12: O4 XD26: O4 $\rightarrow$ O7	CD12-XD10-XB10: O4 CD20-XD26-XB26: O4 $\rightarrow$ O7
* Only available with "FBD" programming language		
Breaking voltage	10.4 $\rightarrow$ 30 V $\overline{\text{---}}$	19.2 $\rightarrow$ 30 V $\overline{\text{---}}$
Nominal voltage	12-24 V $\overline{\text{---}}$	24 V $\overline{\text{---}}$
Nominal current	0.5 A	0.5 A
Max. breaking current	0.625 A	0.625 A
Voltage drop	$\leq 2$ V for I = 0.5 A (at state 1)	$\leq 2$ V for I = 0.5 A (at state 1)
Response time	Make $\leq 1$ ms Release $\leq 1$ ms	Make $\leq 1$ ms Release $\leq 1$ ms
Frequency (Hz)	1 Maximum on inductive load	1 Maximum on inductive load
Built-in protections	Against overloads and short-circuits: Yes Against overvoltages (*): Yes Against inversions of power supply: Yes (* In the absence of a voltfree contact between the logic controller output and the load	Against overloads and short-circuits: Yes Against overvoltages (*): Yes Against inversions of power supply: Yes (* In the absence of a voltfree contact between the logic controller output and the load
Min. load	1 mA	1 mA
Maximum incandescent load	0.2 A / 12 V $\overline{\text{---}}$ 0.1 A / 24 V $\overline{\text{---}}$	0.1 A / 24 V $\overline{\text{---}}$
Galvanic isolation	No	No
PWM frequency	14.11 Hz 56.45 Hz 112.90 Hz 225.80 Hz 451.59 Hz 1806.37 Hz	14.11 Hz 56.45 Hz 112.90 Hz 225.80 Hz 451.59 Hz 1806.37 Hz
PWM cyclic ratio	0 $\rightarrow$ 100 % (256 steps for CD, XD and 1024 steps for XA)	0 $\rightarrow$ 100 % (256 steps for CD, XD and 1024 steps for XA)
PWM accuracy at 120 Hz	< 5 % (20 % $\rightarrow$ 80 %) load at 10 mA	< 5 % (20 % $\rightarrow$ 80 %) load at 10 mA
Max. Breaking current PWM	50 mA	50 mA
Max. cable length PWM	20 m	20 m
PWM accuracy at 500 Hz	< 10 % (20 % $\rightarrow$ 80 %) load at 10 mA	< 10 % (20 % $\rightarrow$ 80 %) load at 10 mA
Status indicator	On LCD screen for CD and XD	On LCD screen for CD and XD

## Differences between Millenium 3 Smart and Millenium 3 Essential



Millenium 3 Smart	
Display	Blue, backlit with white text
Supply versions	24 V $\overline{\text{---}}$ , 12 V $\overline{\text{---}}$ , 100 $\rightarrow$ 240 V $\sim$ , 24 V $\sim$
Operating Temperature	-20 $\rightarrow$ +70 °C/-4 $\rightarrow$ +158 °F (+40 °C/104 °F in non-ventilated enclosure), except CB, XB in $\overline{\text{---}}$ : -30 $\rightarrow$ +70 °C/-22 $\rightarrow$ +158 °F (+40 °C/104 °F in non-ventilated enclosure) in accordance with IEC/EN 60068-2-1 and IEC/EN 60068-2-2
Storage temperature	-40 $\rightarrow$ +80 °C (-40 $\rightarrow$ +176 °F) in accordance with IEC/EN 60068-2-1 and IEC/EN 60068-2-2
More extensions	- XN07 extension for inter-Millenium 3 communication (up to 7 Millenium) - XA03 extension (3 analog inputs for Pt100 temperature probes)
More sensors	Direct connection of NTC temperature probes and LDR luminosity sensors
More functions	Additional application specific functions: Autotuning PID, Astronomical clock, Transfer function $y=f(x)$ , 2 axis solar tracking, ...
Number of function blocks in the library	125

Millenium 3 Essential	
Display	Green, backlit with black text
Supply versions	24 V $\overline{\text{---}}$ , 12 V $\overline{\text{---}}$
Operating Temperature	-20 $\rightarrow$ +55 °C/-4 $\rightarrow$ +131 °F (+40 °C/104 °F in non-ventilated enclosure) in accordance with IEC/EN 60068-2-1 and IEC/EN 60068-2-2
Storage temperature	-40 $\rightarrow$ +70 °C (-40 $\rightarrow$ +158 °F) in accordance with IEC/EN 60068-2-1 and IEC/EN 60068-2-2
More extensions	
More sensors	
More functions	
Number of function blocks in the library	105

# Millenium 3 accessories

**OBSOLETE**

## → Modular power supplies

See our **NEW** Power Supply Family **HERE**

- Switch mode power supply regulated and protected against overloads and short-circuits, easy to integrate into switchboards and enclosures
- The potentiometer can be used to set the output voltage between 100 and 120 % (24 V $\overline{=}$  versions) to compensate for any voltage drops on the line
- The LED continuously signals the presence of voltage at the output and, when flashing, triggering of the self-protection
- Broad range of supply voltage
- Double insulation



7.5 W



30 W



60 W

### Part numbers

Type	Nominal output voltage	Nominal power	Nominal output current	Code
PS	5 V $\overline{=}$ (4.75 V $\rightarrow$ 6.25 V)	20 W	4 A	88950305
	12 V $\overline{=}$ (11.4 V $\rightarrow$ 15 V)	25 W	2.1 A	88950306
	24 V $\overline{=}$ (22.8 V $\rightarrow$ 28.8 V)	7.5 W	0.3 A	88950303
	24 V $\overline{=}$ (22.8 V $\rightarrow$ 28.8 V)	15 W	0.6 A	88950304
	24 V $\overline{=}$ (22.8 V $\rightarrow$ 28.8 V)	30 W	1.2 A	88950307
	24 V $\overline{=}$ (22.8 V $\rightarrow$ 28.8 V)	60 W	2.5 A	88950302

### General characteristics

#### Environmental characteristics

Conformity to standards	IEC/EN 60950-1 IEC/EN 61000-6-2 IEC/EN 61000-6-3 IEC/EN 61204-3 IEC/EN 60364-4-41 – SELV: Safety Extra Low Voltage EN 55022 (CISPR22)
Certifications	CE, UL, CSA, TÜV
Emission	Harmonic: IEC/EN 61000-3-2
Operating temperature	-25 $\rightarrow$ +55 °C
Storage temperature (°C)	-40 $\rightarrow$ +70 °C
Protection class	Class 2 (Double insulation)

#### Electrical characteristics

Input voltage	100 $\rightarrow$ 240 V $\sim$ single-phase (-15 %/+10 %)
Supply frequency range	50/60 Hz (+4 % / -6 %) or 47 $\rightarrow$ 53 Hz/57 $\rightarrow$ 63 Hz
Output voltage	Adjustable from 100 $\rightarrow$ 120 %
Peak current on energisation	< 20 A (Except for 88950302: < 90 A during 1 ms)
Regulation of line and load	$\pm$ 3 %
Immunity from micro power cuts	< 10 ms (100 V $\sim$ ) < 150 ms (230 V $\sim$ )
Thermal protection	Yes
Technology	Primary switch mode electronic power supplies
Short-circuit protection	Yes
Overload protection	Yes
Primary protection	Fuse gG 2 A or circuit breaker 2 A curve D for 88950303, 88950304, 88950305, 88950306, 88950307 Fuse gG 3 A or circuit breaker 3 A curve D for 88950302
Reset after overload	Automatic
Dielectric strength	Input/output 3000 VAC/50 Hz/1 mn
Status indication	LED at the output

#### Mechanical characteristics

Mounting	On section, 35 x 7.5 mm and 35 x 15 mm or on panel (2 x $\varnothing$ 4 mm)
Screw terminals connection capacity	Input connection 2 x 0.14 $\rightarrow$ 2.5 mm $^2$ (AWG 26 $\rightarrow$ AWG 14) Output connection 1 x 0.14 $\rightarrow$ 2.5 mm $^2$ (AWG 26 $\rightarrow$ AWG 14)

## Dimensions (mm)

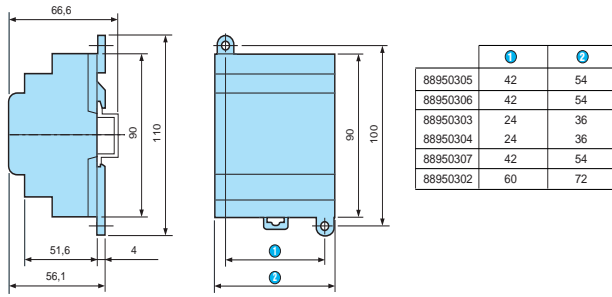

## Curves

### Derating

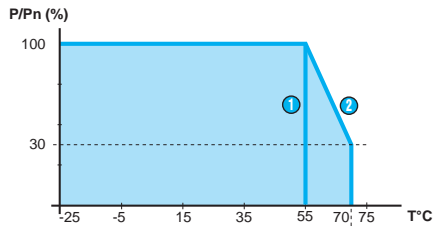

The ambient operating temperature of the Millenium power supplies is 55 °C. Above this, a derating is needed up to a maximum operating temperature of 70 °C. The chart below shows the power (compared to the nominal power) that can be permanently supplied by the power supply depending on the operating temperature

- ① 88950302
- ② 8895030x

# Millenium 3 accessories

## → DC/DC converters

- Power supplies for extended input voltage range
- Provide your devices with a constant supply voltage
- Primary/secondary isolation
- Useful in case of battery use



10 W



6 → 10 W

### Part numbers

Type	Input	Output	Nominal power	Code
PS	9.2-18 V $\overline{\overline{=}}$	12 V $\overline{\overline{=}}$	10 W	88950320
	9.2-36 V $\overline{\overline{=}}$	24 V $\overline{\overline{=}}$	6 → 10 W	88950321

General characteristics	88950320	88950321
Certifications	CE	CE
Output voltage	12 V $\overline{\overline{=}}$ $\pm$ 5 %	24 V $\overline{\overline{=}}$ $\pm$ 5 %
Overshoot	20 V $\overline{\overline{=}}$ max.	40 V $\overline{\overline{=}}$ max.
Input limits	9.2 → 18 V $\overline{\overline{=}}$ (10 W available)	16 → 36 V $\overline{\overline{=}}$ (10 W available) 9.2 → 16 V $\overline{\overline{=}}$ (see graph)
Isolation primary / secondary	1500 V $\overline{\overline{=}}$	1500 V $\overline{\overline{=}}$
Operating temperature	-30 → +70 °C	-30 → +70 °C
Storage temperature (°C)	-40 → +80 °C	-40 → +80 °C
Immunity from micro power cuts	At 10 W: > 1 ms for 9.2 V < U < 12V > 5 ms for U $\geq$ 12 V At 6 W: > 5 ms for all voltage range	At 10 W: > 1 ms for 16 V < U < 18 V 5 ms for U $\geq$ 18 V At 6 W: > 1 ms for U < 12 V > 5 ms for 12 V $\leq$ U < 18 V > 10 ms for U $\geq$ 18 V

### Dimensions (mm)

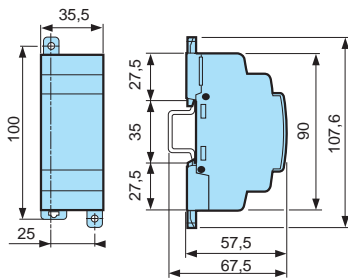

### Curves

#### Input limits

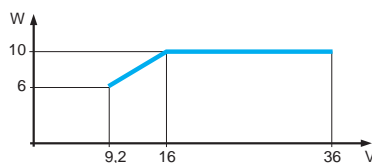

### Product adaptations



- Tropicalization
- Integration in a resin board version

# Millenium 3 accessories

## → Programming tools and softwares

- Millenium 3 software: multilingual software, intuitive operation
- Memory card for loading the application and updating the on-board software (firmware)



M3 Soft



EEPROM memory cartridge

### Part numbers

Type	Description	Code
M3 Soft	Multilingual programming software containing specific library functions (CD-ROM)	88970111
M3 ALARM	Alarm management software (CD-ROM)	88970116
PA	EEPROM memory cartridge	88970108

### General characteristics

M3 Soft is compatible with XP, Vista, Windows 7, Windows 8 from AC8

Minimum recommended configuration : 600 M Hz processor and 256 MB RAM PC

M3 ALARM is used with the modem communication interface (M3MOD) and is compatible with Windows XP

## → Connection accessories

- Direct connection to all types of PC: serial, USB
- Wireless "Bluetooth®" connection for applications that are complex in terms of access



Bluetooth Interface®



Serial programming cable



USB programming cable

### Part numbers

Type	Description	Code
PA	3 m serial programming cable: PC → Millenium 3	88970102
	USB programming cable 3 m: PC → Millenium 3	88970109
	Millenium 3 interface → Bluetooth® (class A 10 m)	88970104
	1.80 m serial link cable: DB9 M/DB9 F	88970123
	500 mm serial programming cable Millenium 3 → DB9 M	88970510

## → Removable connectors

- Millenium 3 can be removed for speedy replacement of the controller
- Cable connection memory to exclude the risk of errors on reconnection
- 2 types available: for Millenium 3 screw-type terminal and for Millenium 3 RBT



Screw-type connectors



Spring cage connectors

### Part numbers

Type	Description	Code
MA	Removable kit for Millenium 3 CD12 or CB12 (screw-type terminal)	88970310
	Removable kit for Millenium 3 CD20 or CB20 (screw-type terminal)	88970311
	Removable kit for Millenium 3 XD26 or XB26 (screw-type terminal)	88970312
MA	Removable connector (spring cage) kit for NBR12, CD12 RBT	88970313
	Removable connector (spring cage) kit for XD26 RBT	88970317

### General characteristics

Screw terminals connection capacity

Cable diameter 0.14 → 2.5 mm<sup>2</sup> AWG 22 - 12

Max. current

12 A (10 A UL)

### Comments

The references 88970310, 88970311, 88970312 are not usable on 100-230 V $\sim$  versions of Millenium 3 for safety reasons

# Millenium 3 accessories

## → Millenium 3 Virtual Display

- Enables an operator to visualize the Millenium 3 Display on a mobile device (smartphone, tablet, PC)
- Makes the development and configuration of Millenium 3 applications easy
- Allows remote monitoring of an equipment
- Makes the display of the Millenium 3 accessible even when the device is out of reach
- Available for Millenium 3 controllers with and without display
- The connection between the Millenium 3 and the device is made via a Bluetooth® interface or via a USB programming cable
- The Millenium 3 Bluetooth® interface is filtered with its unique MAC address (for the Android version)
- Available in a Standard and Lite Version. The Standard Version allows the use of all keys while the Lite Version allows the use of all keys with the exception of the ESC and OK keys
- Android version downloadable on Google Play; Windows XP/7 downloadable on [www.crouzet.com](http://www.crouzet.com)



### Part numbers

Type	Description	Code
Android	Millenium 3 Virtual Display Lite	MVD-AND-L
	Millenium 3 Virtual Display Standard	MVD-AND-S
Windows XP/7	Millenium 3 Virtual Display Lite	MVD-PCW-L
	Millenium 3 Virtual Display Standard	MVD-PCW-S

### Accessories

Type	Description	Code
PA	USB programming cable 3 m: PC → Millenium 3	88970109
PA	Millenium 3 interface → Bluetooth® (class A 10 m)	88970104

### Comments

Compatible with:

- Android v2.2 and more (use the SPP Bluetooth® profile)
- Windows XP or Windows 7 (32 or 64 bit) (Bluetooth® or USB connection)

### Principles

#### Standard Version



#### Lite Version





# Millenium 3 accessories

## → Programmable touch panels MTP6/50, MTP8/50 and MTP8/70

- TFT-LCD compact resistive touch panels, 65536 colors, LED backlight
- Wide viewing angle: 70° horizontally and vertically
- Fan-less cooling system
- Text, data, graphic, animation display
- Processing of alarms and recipes
- 400 MHz core logic, 64 MB RAM
- Direct communication via the Millenium 3 programming port
- Programmable with user-friendly EB software (compatible with Windows 2000/XP/Vista/7)



MTP6/50 - MTP8/50

### Main differentiating characteristics

	MTP6/50	MTP8/50	MTP8/70
<b>Size of display</b>	4.3"	4.3"	7"
<b>Graphical resolution</b>	480 x 272 pixels	480 x 272 pixels	800 x 480 pixels
<b>Storage</b>	128 MB flash memory	128 MB flash memory	128 MB flash memory + SD card slot
<b>Programming</b>	USB Client port	Ethernet port	Ethernet port USB Client port
<b>Communication</b>	RS232/RS485 serial port	RS232/RS485 serial port Ethernet port	2 RS232/RS485 serial ports Ethernet port
<b>Sound output</b>	-	-	yes

### Part numbers

Type	Designation	Size	Programming	Connection	Code
RD	MTP6/50 user kit (fixing brackets, MTP-M3 cable)	4.3"	USB-MiniUSB cable	Direct connection M3-MTP Modbus RS232/RS485 serial port	<b>88970492</b>
	MTP8/50 user kit (fixing brackets, MTP-M3 cable)	4.3"	Ethernet RJ45 crossover cable	Direct connection M3-MTP Modbus RS232/RS485 serial port, Ethernet TCP/IP port	<b>88970494</b>
RD	MTP8/70 user kit (fixing brackets, MTP-M3 cable)	7"	USB-MiniUSB cable or Ethernet RJ45 crossover cable	Direct connection M3-MTP 2 Modbus RS232/RS485 serial ports, USB port, Ethernet TCP/IP port	<b>88970496</b>
PA	MTP6/50-MTP8/70 programming kit – USB-MiniUSB connection (EB/helpfile CD, USB-MiniUSB cable)	-	-	-	<b>88970501</b>
	MTP8/50-MTP8/70 programming kit – Ethernet crossover connection (EB/helpfile CD, RJ45 crossover cable)	-	-	-	<b>88970502</b>

### Accessories

Type	Designation	Code
MA	Modbus cable for MTP6/50 & MTP8/50	<b>88970503</b>
MA	Modbus cable for MTP8/70	<b>88970504</b>

## General characteristics

Environmental characteristics		
Certifications		UL, cUL
Conformity to standards		CEI 61000-4
Operating temperature		0 → +45 °C
Storage temperature (°C)		-20 → +60 °C
Relative humidity		10 → 90 % (operation)
Protection rating		IP65 - Dust and droplets Front panel seal watertight at standard
Vibration resistance		10 - 25 Hz, 2G 30 minutes in each of the X, Y, Z axes
Shock resistance		Free fall from 1 meter in each of the X, Y, Z axes
Electrical characteristics		
Supply voltage		24 V --- Internal insulation via transformer
Voltage limits		19.2 → 28.8 V ---
Consumption		7.2 W max.
Mechanical characteristics		
Dimensions (l x h x w)	MTPx/50	128 x 102 x 38 mm Useful screen area: 95 x 54 mm
	MTP8/70	200 x 146 x 42.5 mm Useful screen area: 154 x 93 mm
Panel cut-out	MTPx/50	119 x 93 mm
	MTP8/70	192 x 138 mm
Panel thickness		1 → 10 mm
Mounting		Built-in, fixing by 2 screw clamps (supplied) for 1 to 10 mm panel
Connection		Removable 3-pin screw terminal block (supplied)
Weight	MTPx/50	~ 300 g
	MTP8/70	~ 800 g
Display characteristics		
Description	MTP6/50, MTP 8/50 and MTP8/70	TFT-LCD polychrome, 65536 colors LED backlight 400 MHz core logic, 64 MB RAM 128 MB flash memory (programs and recipes backup) Programmable with EB software Touch panel with user-definable layout Key life: 1 million operations minimum
	MTPx/50	4.3" Resolution 480 x 272 pixels
	MTP8/70	7" Resolution 800 x 480 pixels SD card memory slot and USB Host port
Display details		Straight lines, free lines, squares, ovals, arcs, polygons, bitmaps, animations.gif, standard fonts
Functions		Buttons, switches, levers, LEDs, messages, data, password-secured buttons, triggers Bar charts, linear gauges, clocks, alphanumeric keyboards, graphics, recipes, alarm lists Text scrolling, multiple windows, data transfer, multiple language Archive
Communication	MTP6/50, MTP 8/50 and MTP8/70	Direct connection M3-MTP (cable supplied) Modbus RS485 connection: 2/4 cables (accessory)
	MTP8/50 and MTP8/70	Modbus TCP/IP connection (Ethernet port)
Programming	MTP6/50	PC-MTP6/50 connection via USB-MiniUSB cable (accessory)
	MTP8/50	PC-MTP8/50 connection via Ethernet RJ45 cross-over cable (accessory)
	MTP8/70	PC-MTP8/70 connection via USB-MiniUSB cable (accessory) or via Ethernet RJ45 cross-over cable (accessory)
Real-time clock		Uses Millenium 3 clock or built-in clock

## Dimensions (mm)

### MTP6/50 and MTP8/50

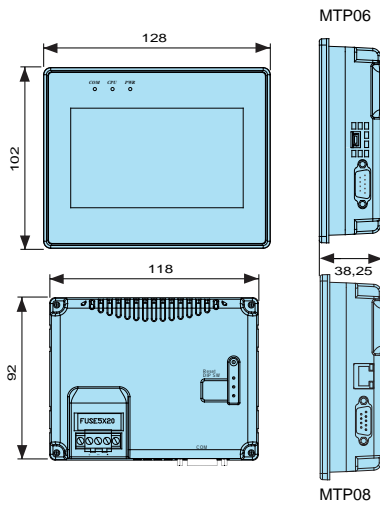

### Panel cut-out

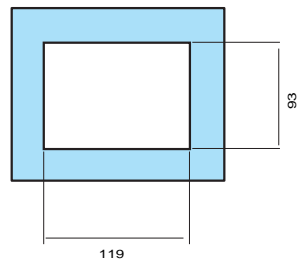

### MTP8/70

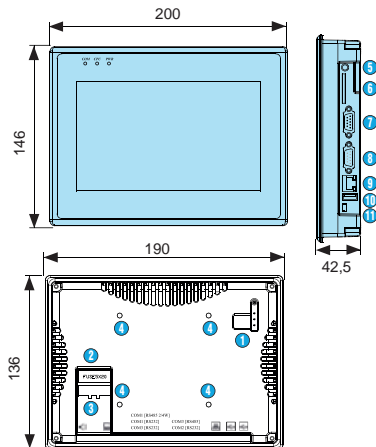

### Panel cut-out

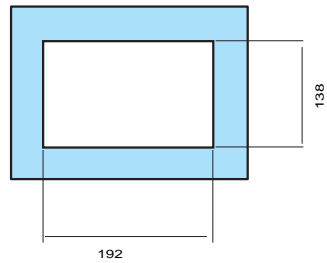

- ① DIP SW & Reset button
- ② Fuse
- ③ Power connector
- ④ VESA 75 mm screw holes
- ⑤ Audio
- ⑥ SD card slot
- ⑦ Com1 RS485, Com3 RS485, Com3 RS232
- ⑧ Com1 RS232, Com2 RS232
- ⑨ Ethernet port (RJ-45)
- ⑩ USB Host port
- ⑪ USB client port (programming)

# Millenium 3 accessories

## → Remote LCD displays/keypads

- Direct link with Millenium 3 via cable
- Highlight the data and parameters information of your automation application
- Backlit LCD screen with 4 lines of 18 characters and keypad with 6 keys or 10 keys and 4 LEDs
- Direct communication with the Millenium 3 via the programming port
- Plug and play: no additional software (the function keys and LEDs are controlled by the M3 Soft SLIn/ SLOut function blocks)
- Check bit for controlling communication
- Universal screen compatible with any Millenium 3 logic controller (standard, budget, expandable, bare board, resin board)



Remote LCD screen/keypad



Remote LCD screen/keypad + 4 function keys + 4 LEDs

### Part numbers

Type	Designation	Code
RD1	Remote LCD screen/keypad Kit with remote LCD screen/keypad + 3 m cable	88970410 88970412
RD2	Remote LCD screen/keypad + 4 function keys + 4 LEDs Kit with remote LCD screen/keypad + 4 function keys + 4 LEDs + 3 m cable	88970411 88970413

### Accessories

Type	Designation	Code
MA	IP65 protective membrane (in accordance with DIN 40050 and EN60529)	88970414
PA	3 m serial programming cable: PC → Millenium 3	88970102
PA	1.80 m serial link cable: DB9 M / DB9 F	88970123

### General characteristics

Environmental characteristics	
Certifications	CE
Dimensions (l x h x w)	96.6 x 72.8 x 63 mm
Panel cut-out	92 x 68 mm
Protection rating	IP54 on front panel IP20 on rear panel
Electrical characteristics	
Supply voltage	24 V $\overline{\text{DC}}$ (the power supply has to be common with the Millenium 3 power supply)
Voltage limits	- 20 %/+ 25 % or 19.2 → 30 V $\overline{\text{DC}}$ (including ripple)
Consumption	1.5 W (88970410) 2 W (88970411)
Protection against polarity inversions	yes
Mechanical characteristics	
Mounting	Flush-mounted, fixed with 2 clips (supplied)
Display protection	Polyester
Keyboard material	Polyester
Housing material	Self-extinguishing UL94V1
Connection	Removable 2-pin terminal
Connection	Serial via 9-pin male SUB D connector
Cable length	3 m maximum
Display characteristics	
Cycle time	20 ms + 2 Millenium 3 Controller cycles (88970410 and 88970412) 50 ms + 10 Millenium 3 Controller cycles (88970411 and 88970413)
Comments	
If using a remote display/keypad with a Millenium 3 resin board version, order the DB9/DB9 serial programming cable separately (Part no. 88970123)	

# Dimensions (mm)

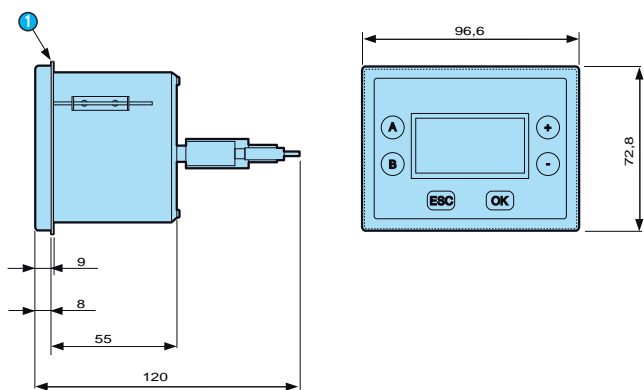

1 Seal

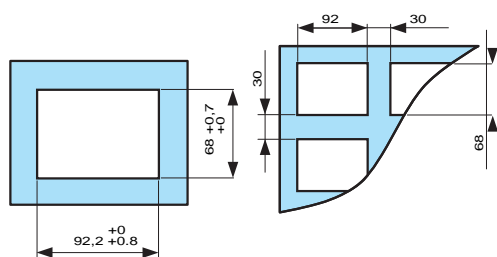

## Backside

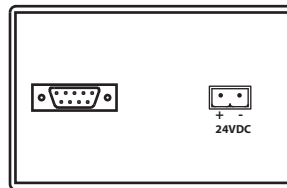

# Millenium 3 accessories

## → Remote LED display - Input 0-10 V

- Highlight the data of your automation application
- Display (36 x 72 mm) with 4 x 14 mm red digits
- Configurable display range
- 0-10 V input
- IP65 degree of protection on front panel



### Part numbers

Type	Description	Supply	Code
RD	Display with 4 x 14 mm red digits	24 V $\overline{\text{---}}$	88950400

### General characteristics

Environmental characteristics	
Certifications	CE
Conformity to standards	IEC/EN 61000-6-4, IEC/EN 61010-1
Protection rating	In accordance with IEC/EN 60529: IP65 on front panel IP20 on rear
Operating temperature	-10 → +55 °C
Dimensions (l x h x w)	36 x 72 x 61 mm
Panel cut-out	71 x 29 mm
Electrical characteristics	
Supply	24 V $\overline{\text{---}}$
Tolerance	± 10 %
Consumption	< 1 W
Input voltage	0 → 10 V $\overline{\text{---}}$
Mechanical characteristics	
Mounting	Flush-mounted
Connection	Terminal block
Display characteristics	
Height of digits	14 mm
Number of digits	4
Colour	Red
Range	-1999...5999 with selectable decimal point
Device accuracy (full scale)	≤ ± 0.3 % of interval
Comments	
Can be connected directly to an analog output or via a PWM/0-10 V converter	

### Dimensions (mm)

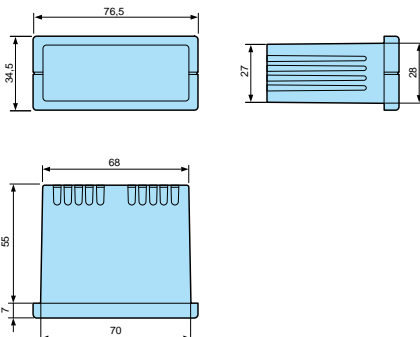

# Millenium 3 accessories

## → Modem communication plug and play solutions

- For remote control of your application
- Automatic notification of alarms via SMS (GSM Modem) / email or on a PC with M3 ALARM software.
- Millenium 3 program can be downloaded, modified and sent
- Input and output states, as well as all program values, can be polled and controlled remotely
- 2 types of pre-configured ready-to-use modem:
  - STN modem for wired transmission networks
  - GSM modem for wireless communication



M3MOD



STN Modem



GSM Modem

### Part numbers

Type	Description	Supply	Code
M3MOD	Modem communication interface	12-24 V ---	88970117
RTC	STN modem	12-24 V ---	88970118
GSM	GSM modem 850/900/1800/1900 MHz	12-24 V ---	88970119

### Accessories

Type	Description	Code
PA	1.80 m serial link cable: DB9 M/DB9 F	88970123
M3 ALARM	Alarm management software (CD-ROM)	88970116

### Specific characteristics\*

	88970117	88970118	88970119
Certifications	CE, UL, CSA	CE, UL, CSA	CE, R&TTE, UL, CSA, FCC, IC

### Supply

Nominal voltage (V)	12 → 24 V ---	12 → 24 V ---	12 → 24 V ---
Operating limits	-13 % / +20 % or 10 → 28.8 V ---	-13 % / +5 % or 10 → 30 V ---	-54 % / +33 % or 5.5 → 32 V ---
Ripple	5 % max.	-	-
Nominal current under 12 V DC	30 mA	140 mA	165 mA
Nominal current under 24 V DC	30 mA	70 mA	87 mA
Peak current on energisation	550 mA	9600 mA	2100 mA at 5.5 V
Max. absorbed power	1.1 W	1.7 W	2.1 W
Immunity from micro power cuts	1 ms, repetition 20 times	-	-
Protection against polarity inversions	Yes	No	No
Fuse protection	1 A fuse	-	Supplied with fuse 2.5 A
Temperature Use (°C)	-20 → +55 °C	-30 → +70 °C	-20 → +55 °C
Storage temperature (°C)	-40 → +70 °C	-40 → +85 °C	-25 → +70 °C

### Characteristics of the "COM-M3" link with the controller

Type of connector	Specific Millenium
Type of link	Specific Millenium communication protocol
Compatibility	Only with Millenium controllers version ≥ V2.1
Isolation of "Com-M3" connector from the "Com-M" connector	Via optocoupler ~ 1780 V
Isolation of "Com-M3" connector from the ± supply terminals	Via optocoupler ~ 1780 V

\*Also see Millenium 3 Smart and Essential General characteristics

## Characteristics of "Com-M" link with the Modem

Type of connector	Specific Millenium
Type of link with Modem connector cable	RS 232 serial (supplied with the communication interface)
Compatibility	Only with Millenium controllers version $\geq$ V2.1
Analog RTC modem compatibility	AT commands
GSM modem compatibility	AT commands
Isolation of "Com-M" connector from the Modem	Via link cable to Modem (supplied)
Isolation of "Com-M" connector from the $\pm$ supply terminals	Via link cable to Modem (supplied)

## Characteristics of "Com-M" link with the Modem

Data saved by the interface	Up to 28 messages 1 to 10 recipients (telephone numbers and/or e-mail addresses) per message Time-stamping of messages to be sent (date and time) Saving of values on triggering of the message activation condition (digital and numerical values)
Backup of data to be sent	Flash memory

## Dimensions (mm)

Modem communication interface M3MOD

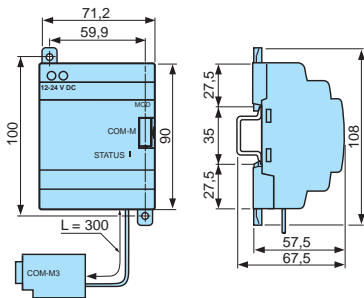

RTC

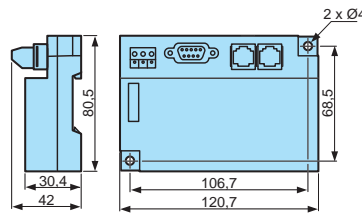

GSM Mounting profile

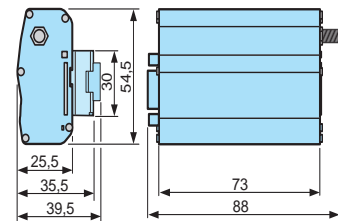

GSM Mounting screws

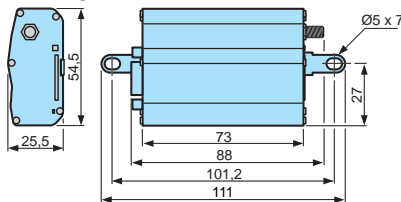

## Principles

### Functions available depending on the hardware architecture and/or type of SIM card

Functions	Remote station device				
	STN modem	GSM modem			
		Type of SIM card			
		Data	Data voice		Voice
		Data n°	Voice n°		
Send alarm/receive instructions with GSM telephone					
Send alarm/receive instructions with PC running "M3 ALARM" software <sup>(1)</sup>					
Transfer program Update firmware Monitoring <sup>(1)</sup>					
Send alarm to e-mail address					

Functions available
  Functions not available

**Nota:** Instructions cannot be transmitted by e-mail

<sup>(1)</sup> When using a GSM Modem on the PC side, the SIM card must have a DAT number.



# Millenium 3 accessories

## → NTC probes

- Direct connection with no converter on analog input
- Easy-to-use and low-cost temperature control solution
- Fields of application: HVAC, compressors, geothermal systems, swimming pools, fountains
- Analog input configured as a potentiometer via the NTC functions in the M3 Soft (minimum AC5)



NTC PVC probe



NTC probe



NTC stainless probe



POM probe



Silicone probe

### Part numbers

Type	Description	Ohmic value	Measurement range	Code
PVC	NTC2 probe PVC for Millenium 3 (24 V $\pm$ 10 %)	10 k $\Omega$ @ 25 °C	-25 → +85 °C	<b>89750174</b>
AS	NTC1 probe (batch of 10) for Millenium 3 (24 V $\pm$ 10 %)	10 k $\Omega$ @ 25 °C	-25 → +85 °C	<b>89750180</b>
Stainless	NTC2 probe stainless 305 for Millenium 3 (24 V $\pm$ 10 %)	10 k $\Omega$ @ 25 °C	-35 → +120 °C	<b>89750182</b>
POM	NTC2 probe silicone for Millenium 3 (24 V $\pm$ 10 %) MOQ 25 pcs	10 k $\Omega$ @ 25 °C	-20 → +105 °C	<b>89750185</b>
Silicone	NTC3 probe silicone for Millenium 3 (24 V $\pm$ 10 %)	100 k $\Omega$ @ 25 °C	0 → +180 °C	<b>89750186</b>

### Accessories

Accessories	Operating temperature	Operating pressure	Code
316 stainless steel protective sleeve	-20 → +400 °C	16 bar	<b>89750147</b>

General characteristics	89750174	89750180	89750182	89750185	89750186
	Precision (Repetability)	Precision (Repetability)	Precision (Repetability)	Precision (Repetability)	Precision (Repetability)
<b>Environmental characteristics</b>					
-35 → +40 °C			$\leq \pm 0.8$ °C ( $\leq \pm 0.5$ °C)		
-25 → +40 °C	$\leq \pm 0.8$ °C ( $\leq \pm 0.5$ °C)	$\leq \pm 0.8$ °C ( $\leq \pm 0.5$ °C)			
-20 → +40 °C				$\leq \pm 0.8$ °C ( $\leq \pm 0.5$ °C)	
0 → +40 °C					$\leq \pm 3$ °C ( $\leq \pm 1$ °C)
+40 → +50 °C		$\leq \pm 1.2$ °C ( $\leq \pm 1$ °C)			
+40 → +70 °C	$\leq \pm 2$ °C ( $\leq \pm 1$ °C)		$\leq \pm 2$ °C ( $\leq \pm 1$ °C)	$\leq \pm 2$ °C ( $\leq \pm 1$ °C)	
+40 → +140 °C					$\leq \pm 2$ °C ( $\leq \pm 1$ °C)
+50 → +60 °C		$\leq \pm 1.4$ °C ( $\leq \pm 1.4$ °C)			
+60 → +70 °C		$\leq \pm 2$ °C ( $\leq \pm 2$ °C)			
+70 → +85 °C	$\leq \pm 3$ °C ( $\leq \pm 2$ °C)	$\leq \pm 3$ °C ( $\leq \pm 2$ °C)			
+70 → +105 °C				$\leq \pm 3$ °C ( $\leq \pm 2$ °C)	
+70 → +120 °C			$\leq \pm 3$ °C ( $\leq \pm 2$ °C)		
+140 → +180 °C					$\leq \pm 3$ °C ( $\leq \pm 1$ °C)

Charcteristics	89750174	89750180	89750182	89750185	89750186
Material	PVC	AS	Stainless	POM (polyoxymethylene)	Silicone
Cable	PVC	2 wires	Silicone (180 °C max.)	PVC (105 °C max.)	Silicone (200 °C max.)
Cable length	3000 mm	600 mm	3000 mm	3000 mm	800 mm
Protection rating	IP67	IP67	IP64	IP67	IP64
Isolation class	-	-	1	2	1
Dielectric strength according to IEC 335	-	1000 V ~ / 1 mn	1250 V ~ / 1 mn	-	2000 V ~ / 1mn
Dimensions	Flank lead 1/2" Length 68 mm	5 x 6 mm Length 15 mm	Ø 4.8 mm Length 30 mm	Ø 6 mm Length 38 mm	Ø 5 mm Length 17 mm
Analog inputs are configured as a potentiometer in the M3 Soft programming software via the function:					
	NTC2	NTC1	NTC2	NTC2	NTC3

## Dimensions (mm)

89750180

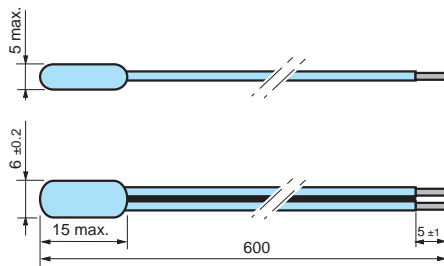

89750174

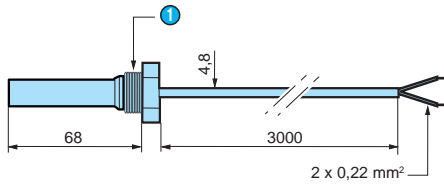

① 1/2 inch thread

89750185

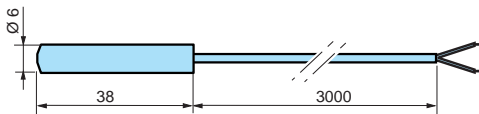

89750182

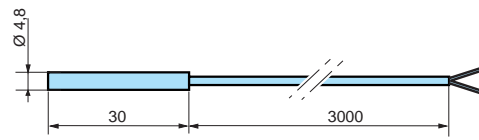

89750186



## Connections

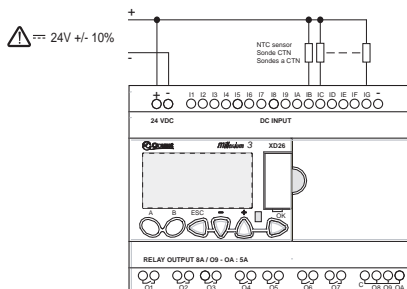

# Millenium 3 accessories

## → LDR probe

- Direct connection with no converter on analog input
- Low cost light control solution
- Fields of application:
  - Lighting control
  - Energy saving
  - Building management



### Part numbers

Type	Description	Measurement range	Code
AS	Light sensor LDR1 for Millenium 3 (24 V $\pm$ 10 %)	10 → 3000 Lux	89750183

### General characteristics

#### Environmental characteristics

Accuracy	< 10 % of full scale
Peak spectral response	600 $\pm$ 20 nm
Drift Temperature (%/ °C)	0.5 %/ °C
Operating temperature	-20 → +70 °C
Storage temperature	-20 → +70 °C

#### Mechanical characteristics

Cable length	3000 mm
Protection rating	IP64
Mounting by screw	Ø 5 mm
Mounting	Hole Ø 10 mm, thickness 9 mm max.

Analog input configured as potentiometer via the function (LUX-1, with M3 Soft software part no.: 88970111).

Probes only available on the Smart range (88974XXX, NB, NBR)

### Dimensions (mm)

89750183

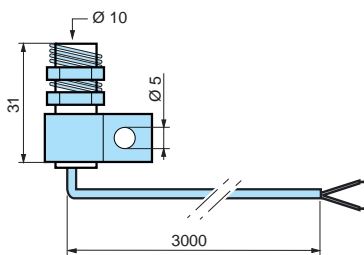

### Connections

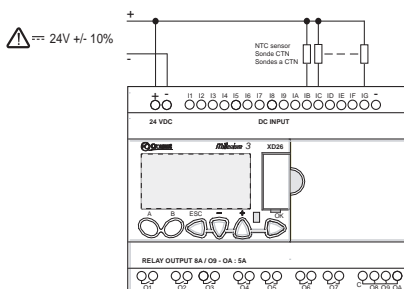

# Millenium 3 accessories

## → Temperature sensors

- Integrated converter: 0-10 V output for direct connection to the Millenium 3 analog inputs



Zone/space probe



Ventilation duct



External probe

### Part numbers

Type	Description	Range	Accuracy	Supply	Protection casing	Protection probe	Code
AS	Zone/space	-10 → +40 °C	-0.2 °C +1.2 °C	24 V $\overline{\text{---}}$	IP30	-	89750150
	Ventilation duct	-10 → +60 °C	-0.2 °C +1.9 °C	24 V $\overline{\text{---}}$	IP65	IP30	89750151
	External	-10 → +40 °C	-0.2 °C +1.2 °C	24 V $\overline{\text{---}}$	IP65	-	89750152
	Remote/submersible probe	-10 → +110 °C	-0.2 °C +1.2 °C	24 V $\overline{\text{---}}$	IP65	IP67	89750153

### Accessories

Accessories	Operating temperature	Operating pressure	Code
316 stainless steel protective sleeve	-20 → +400 °C	16 bar	89750147

### General characteristics

#### Environmental characteristics

Ambient temperature	-10 → +60 °C
Ambient humidity	5 → 95 % RH
Housing material	Self-extinguishing
Certifications	CE

#### Electrical characteristics

Supply voltage	24 V $\overline{\text{---}}$ ( $\pm 10\%$ )
Output	0 → 10 V $\overline{\text{---}}$
Drift Temperature (%/ °C)	0.01 %/ °C of full scale
Temperature coefficients Offset	1.5 mV/ °C

### Dimensions (mm)

#### 89750150

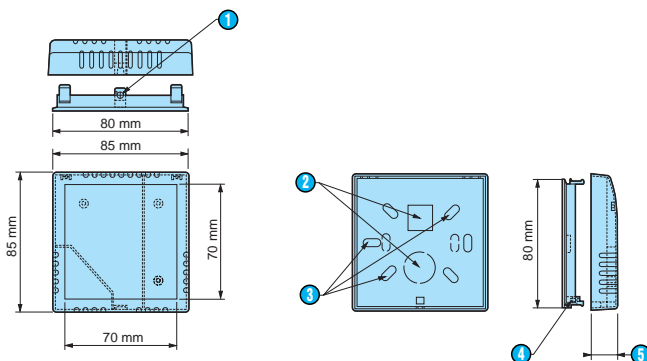

- ① Ø3 mm for M3 x 8 screw
- ② Cut-outs made prior to delivery
- ③ Fixing holes
- ④ Indentation for M3 square nut
- ⑤ Total depth 26 mm

#### 89750151

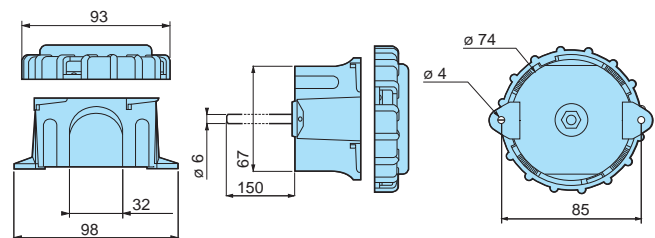

## Dimensions (mm)

89750152

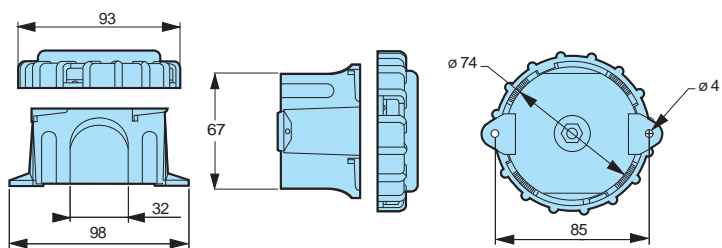

89750153

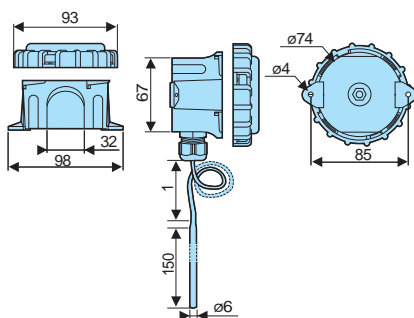

Accessory 89750147 for 89750153

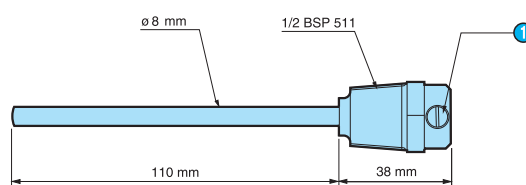

① M4 screw

# Millenium 3 accessories

## → Temperature probes

- Thermocouple J:
  - Nickel-plated brass eyelet
  - Stainless steel casing
  - Stainless steel sheath
- Thermocouple K
- Pt100 Class B:
  - Stainless steel sheath
  - Aluminium vee
- Connection/Sub-base/Flange
- Pt100 for use with XA03 and XA04 extension
- Thermocouple for use with temperature converter



### Part numbers

Type	Description	Temperature	Characteristics	Code
Thermocouple /Pt100	Thermocouple probe J	max.: 400 °C	Thermocouple probe J with nickel-plated brass eyelet Ø 6.5 mm, connection sleeve Ø 5 x 30 mm in stainless steel 316 L. Glass filament cable with stainless steel braid: 2 m long Hot junction isolated from earth	79696030
	Thermocouple probe J	max.: 600 °C	Thermocouple probe J with casing St. steel 304 L Ø 3 mm: 500 mm long PVC cable: 2 m long Junction cannot be removed Junction isolated from earth	79696031
	Thermocouple probe J	max.: 400 °C	Thermocouple probe J with sheath ST steel 316 L Ø 5 mm: 30 mm long Glass filament cable with stainless steel braid: 2 m long Junction isolated from earth	79696033
	Thermocouple probe J	max.: 400 °C	Thermocouple probe J with sheath St. steel 16 L Ø 6 mm: 200 mm long Glass filament cable with stainless steel braid: 2 m long Junction isolated from earth	79696032
	Thermocouple probe K	max.: 1100 °C	Thermocouple probe K with casing St. steel 304 L Ø 3 mm: 500 mm long PVC cable: 2 m long Junction isolated from earth	79696034
	Pt100 probe Class B	max.: 200 °C	Pt100 probe Class B with sheath St. steel 316 L Ø 6 mm: 200 mm long Silicon teflon cable: 2 m long 3-wire assembly	79696035
	Pt100 probe Class B	max.: 200 °C	Pt100 probe Class B Aluminium vee: 50 mm long Silicom teflon cable: 2 m long 3-wire assembly - Supplied with fixing clamp	79696037
	Pt100 probe Class B	max.: 400 °C	Pt100 probe Class B with sheath St. steel 316 L Ø 6 mm: 30 mm long Glass filament cable with stainless steel braid: 2 m long 2-wire assembly	79696036

### Accessories

Accessories	Characteristics	Code
Connection	Sliding connection 1/4 " BSP CYL. St. steel 316 L Ø 3 mm	79696038
	Sliding connection 1/4 " BSP CYL. St. steel 316 L Ø 6 mm	79696039
	Sliding connection 1/2 " BSP CYL. St. steel 316 L Ø 6 mm	79696040
Sub-base	Sliding connection 1/4 " BSP CYL Ø 12 mm Nickel-plated steel	79696041
Flange	Inox flange Ø 6 mm	79696042

## Dimensions (mm)

Connection: 79696038

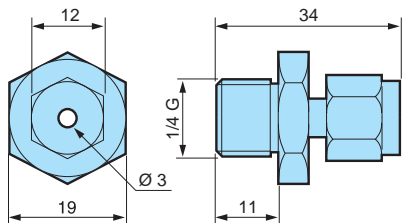

Connection: 79696039

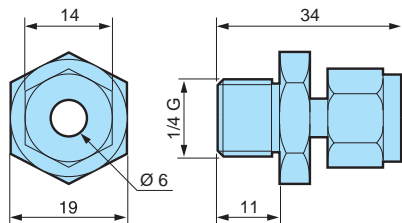

Connection: 79696040

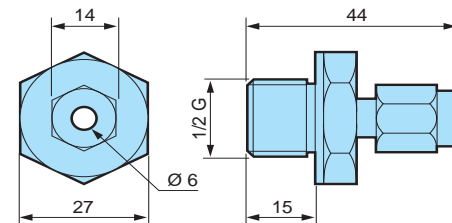

Sub-base: 79696041

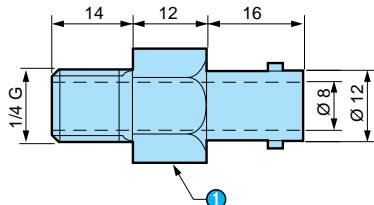

Flange: 79696042

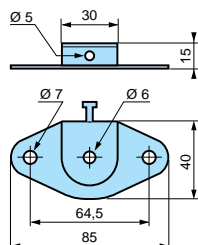

① 17 across flat

Thermocouple probe J: 79696030

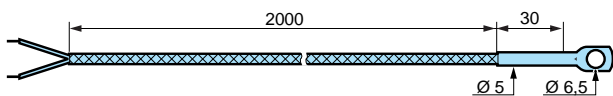

Thermocouple probe J: 79696031

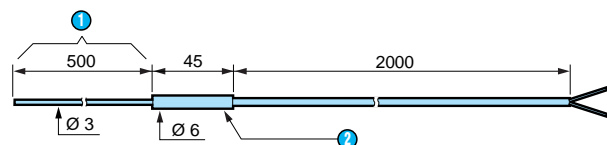

Thermocouple probe J: 79696032

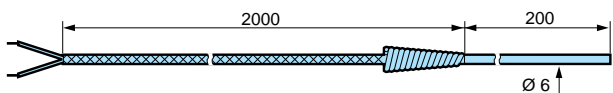

Thermocouple probe J: 79696033

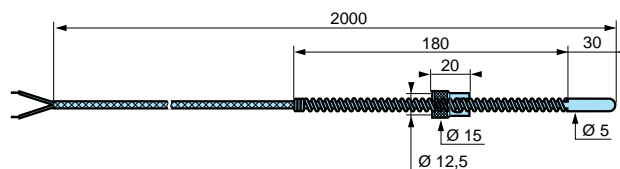

Thermocouple probe K: 79696034

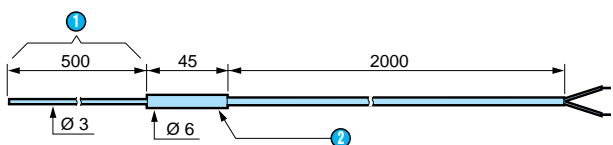

- ① Flexible
- ② Stainless steel sleeve

Pt100 probe Class B: 79696035

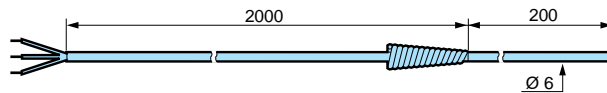

Pt100 probe Class B: 79696036

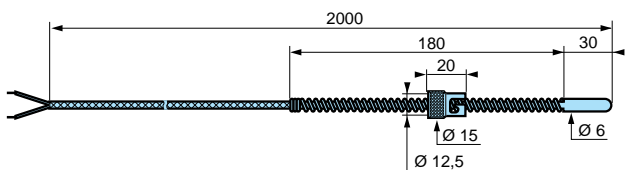

Pt100 probe Class B: 79696037

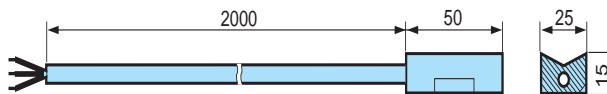

Aluminium vee (This part is removable)

# Millenium 3 accessories

## → Temperature converters

- Compatible with Millenium 3 analog inputs
- Can be used to diversify the type of sensors for analog inputs



### Part numbers

Type	Description	Input	Input range	Output	Code
AC	Converter	Pt1000 3-wire	-20 → +150 °C	0-10 V	<b>88950150</b>
	Converter	Pt100 3-wire	-40 → +40 °C	0-10 V	<b>88950151</b>
	Converter	Pt100 3-wire	0 → +100 °C	0-10 V	<b>88950152</b>
	Converter	Pt100 3-wire	0 → +250 °C	0-10 V	<b>88950153</b>
	Converter	Thermocouple J	0 → +300 °C	0-10 V	<b>88950154</b>
	Converter	Thermocouple K	0 → +600 °C	0-10 V	<b>88950155</b>

### General characteristics

#### Ambient characteristics

Certifications	CE
Protection rating	In accordance with IEC/EN 60529: IP40 on front panel IP20 on terminal block
Operating temperature	-10 → +55 °C

#### Electrical characteristics

Supply	24 V $\overline{\text{---}}$
Operating limits	$\pm 10 \%$ or 21.6 → 26.4 V $\overline{\text{---}}$
Max. Output power	< 1 W
Output voltage	0 → 10 V $\overline{\text{---}}$
Device accuracy (full scale)	$\pm 1 \%$

### Dimensions (mm)

#### Temperature converter

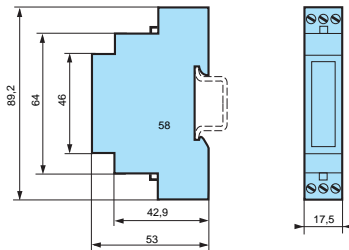

### Connections

#### Temperature converter

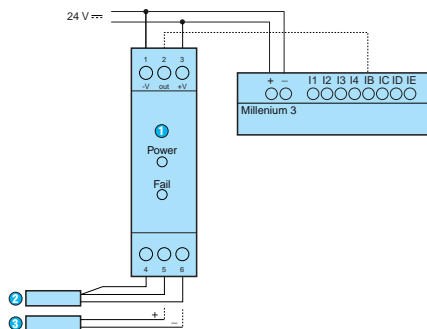

- 1) Temperature converter: Pt100/Pt1000 thermocouple J/K
- 2) Pt100 3-wire
- 3) Thermocouple



# Millenium 3 accessories

## → Signal converters

- Current/voltage conversion of Millenium 3 input signals
- PWM/voltage conversion of Millenium 3 output signals



### Part numbers

Type	Description	Input	Output	Code
AC	0-20 mA/0-10 V input converter	4	4	88950108
	PWM/0-10 V output converter	1	1	88950112

### General characteristics

88950108

88950112

Current/voltage converter

PWM/0-10 V converter

### Environmental characteristics

Certifications	CE	CE
Protection rating	In accordance with IEC/EN 60529: IP20 terminal block IP50 casing	In accordance with IEC/EN 60529: IP20
Operating temperature	-20 → +85 °C	-20 → +55 °C
Storage temperature	-40 → +85 °C	-25 → +70 °C

### Electrical characteristics

Supply	-	24 V $\overline{\text{DC}}$ (+10 % / -15 %)
Input current	0-20 mA	-
Output voltage	0-10 V $\pm$ 5 %	0-10 V $\pm$ 5 %
Impedance	500 $\Omega$ (input)	250 $\Omega$ (maximum load)
Max. current	40 mA	40 mA (output)
Input PWM	-	24 V $\overline{\text{DC}}$ (+20 % / -15 %, 120 Hz max.)
Short-circuit protection	-	Yes
Protection against polarity inversions	-	Yes (>10 s)
Absorbed power	0.8 W	1.3 W
Conversion time	-	440 ms (max): 0 → 100 % & 100 % → 0

### Mechanical characteristics

Cable length	< 30 m with shielded cable	< 10 m with shielded cable
--------------	----------------------------	----------------------------

### Dimensions (mm)

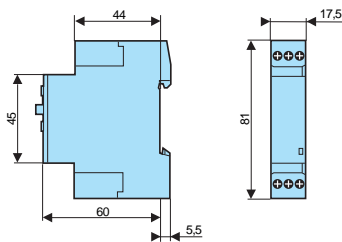

### Connections

#### PWM/0-10 V output converter

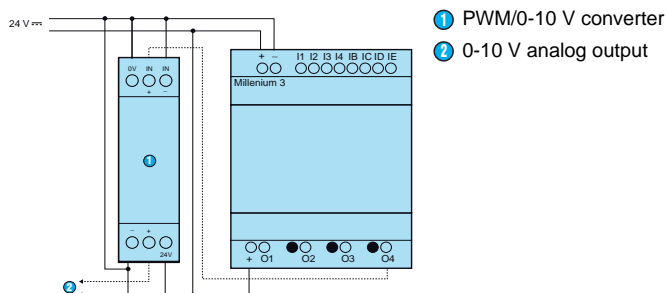

#### 0-20 mA/0-10 V input converter

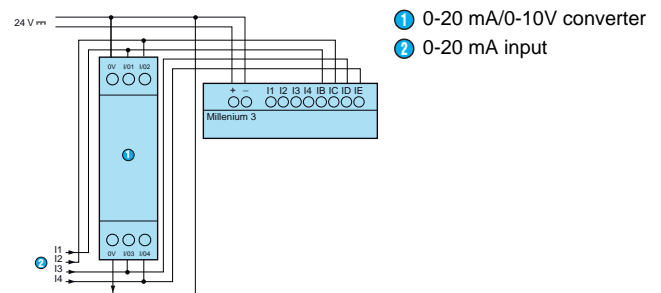

# Millenium 3 accessories

## → Potentiometer Ø 22 mm

- Direct-read potentiometer (controlled externally)  
Ø 22 mm
- IP65 degree of protection on front panel
- Directly compatible with the "Potentiometer" parameter of an analog input on the Millenium 3



### Part numbers

Type	Description	Supply	Code
EP	External potentiometer for value adjustment	30 V $\overline{\text{---}}$ max	88950109

### General characteristics

#### Environmental characteristics

Protection rating	In accordance with IEC/EN 60529: IP65 on front panel IP10 on terminal block
Operating temperature	-20 → +60 °C
Storage temperature	-20 → +70 °C

#### Electrical characteristics

Ohmic value	4700 $\Omega$
Tolerance	$\pm 20 \%$
Power	150 mW

#### Mechanical characteristics

Screw terminals connection capacity	1 x 4 mm <sup>2</sup> rigid 1 x 2.5 mm <sup>2</sup> flexible
-------------------------------------	---

### Dimensions (mm)

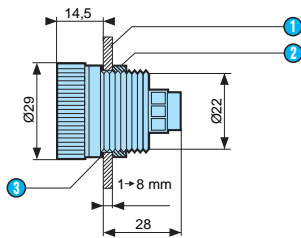

- ① Panel
- ② Nut
- ③ Seal

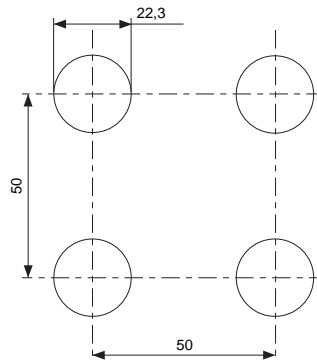

### Connections

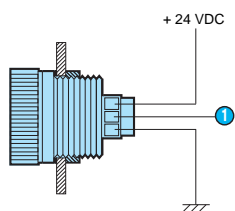

- ① Analog input

# Millenium 3 accessories

## → Faceplates

- IP67: sealing on front panel, panel-mounting of the Millenium 3
- IP40: direct access to the front of the controller, possibility of labelling (laser marking)



IP67 faceplate



IP40 faceplate

### Part numbers

Type	Description	Code
MA	IP67 sealed faceplate for the following products: - XD10 or CD12	89750160
	IP67 sealed faceplate for the following products: - XD10 + XR06 or XN03 or XN05 or XA04 - CD20 or XD26 - XD10 + XN03 or XN05 + XR06 or XA04 - XD10 + XR10 or XR14	89750161
	IP67 sealed faceplate for the following products: - XD26 + XR06 or XN03 or XN05 or XA04 - XD10 + XN03 or XA04 + XR10 or XR14 - XD10 + XE10 + XR06 or XA04 - XD26 + XN03 or XN05 + XR06 or XA04 - XD26 + XR10 or XR14 - XD10 + XE10 + XR10 or XR14 - XD26 + XE10 + XR06 or XA04 - XD26 + XN03 or XN05 + XR10 or XR14	89750162
MA1	IP40 faceplate: CD12 or XD10	88970809
	IP40 faceplate: CD20 or XD26	88970810

### Dimensions (mm)

#### IP40

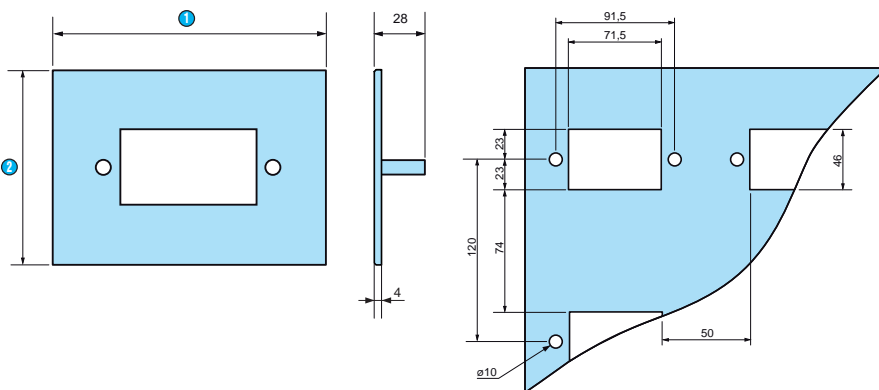





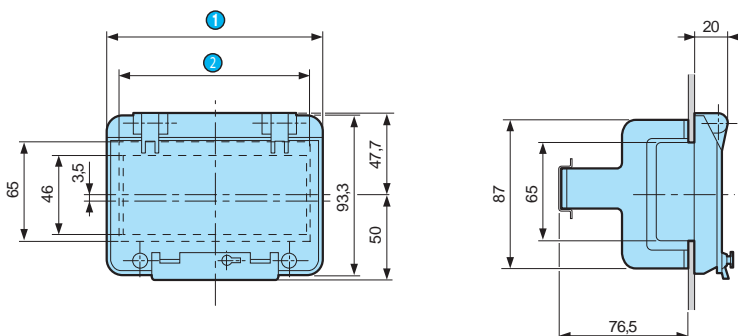























- ① 88970809 = 110  
88970810 = 155
- ② 88970809 = 108  
88970810 = 108



























#### IP67













- ① 88750160 = 91  
88750161 = 162  
88750162 = 257.4
- ② 88750160 = 76.5  
88750161 = 147.5  
88750162 = 248.5

# Function blocks











APPLICATION		
	<b>Cam Bloc</b>	Control of a group of 8 integral cam wheels.
	<b>Angular Cam Timer</b>	Cam timer with the angle made by the cams as the command input.
	<b>Pumps management</b>	Pumps Management (Tank Management with circular pump changeover).
	<b>Sunrise Sunset Time</b>	Calculation of the sunrise and sunset time in relation to the latitude and longitude.
	<b>Solar Tracking one Axis</b>	Calculation of the sun's position so that a sun dial can be placed.
	<b>Analog PID Regulation (8 bits)</b>	Temperature control (pressure or other) with 8 bits analog output.
	<b>PWM PID Regulation (8 bits)</b>	Temperature control (pressure or other) with 8 bits digital output.
	<b>Pressure Gain</b>	Interface between a Pressure Sensor and the Millenium 3 logic controller.
	<b>Flow</b>	Calculation of the flow of a liquid in a pipe using a differential pressure element or by measuring the dynamic pressure.
	<b>Level</b>	Calculation of the level of a liquid with or without constant density, in an open or closed tank, using pressure sensors.
	<b>CTN 1</b>	Temperature measurement. It is dedicated to CTN1 (-25 to +85 °C).
	<b>CTN 2</b>	Temperature measurement. It is designed for CTN2 type NTCs (-35°C to +120°C).
	<b>CTN 3</b>	Temperature measurement. It is designed for CTN3 type NTCs (0°C to +200°C).
	<b>LUX-1</b>	Light measurement. It is designed for photoresistors and internal light meters.
	<b>Twilight</b>	Calculation of the sunrise and sunset times and also the twilight times in relation to the latitude and longitude read on the function block inputs.
	<b>Solar Tracking Dual Axis</b>	Calculation of the sun's position so that a sun dial can be placed. This positioning depends on the two angles calculated by the function: the elevation angle and the azimuth angle.
	<b>Swimming Pool Filtration</b>	Filtration time information in relation to the water temperature.
	<b>Defrost</b>	Defrost cycle management
	<b>Heat Curve</b>	Modulation of the heating water temperature according to the atmospheric conditions. The function uses automatic regulation depending on the temperature outdoors called the temperature curve or "water ratio".
	<b>Analog PID Regulator (Auto-tuning)</b>	Auto-tuning proportional-integral-derivative (PID) controller.
PROG		
	<b>Constant On</b>	Constant On
	<b>Constant Off</b>	Constant Off
	<b>Yes Bit</b>	Copy of the input to the output. (very helpful when macros are being used)
	<b>Numerical Constant</b>	Integer with a value between -32768 and +32767.
	<b>Yes Num</b>	Copy of the input to the output. (very helpful when macros are being used)
	<b>Memory</b>	Saving of a value between -32768 and 32767.
	<b>Storage</b>	Storage of data values with an average value.
	<b>Archive</b>	Saving of two values simultaneously with the information relating to their time-stamping.
	<b>Random</b>	Generation of a pseudo-random value between the min and max values set by the user.

CALCUL		
	<b>Gain</b>	Conversion of an analog value by changing the scale and offset.
	<b>Add/Subb</b>	Simple operations on integers: Addition and/or Subtraction.
	<b>Mul/Div</b>	Simple operations on integers: Multiplication and/or Division.
	<b>ADD/SUB 2 Inputs</b>	The ADD-SUB (Addition or Subtraction) function is used to perform simple operations on integers.
	<b>Sin/Cos</b>	Calculation of the cos and sin of an angle between 0° and 90°.
	<b>Square Root</b>	Calculation of the square root of the number present as an input with accuracy to two decimal points.
	<b>Bit Multiplexer</b>	Copy of the selected A or B input to the outputs Q and Q.
	<b>Multiplexer A B</b>	Multiplexing function on 2 analog values.
	<b>Demultiplexer</b>	Demultiplexing of integers. Used to direct the value of the input to one of the 4 outputs.
	<b>Multiplexer</b>	Multiplexing word inputs. Used to direct the value of one of the selected inputs to a predefined output.
	<b>Dec/Bin</b>	Break down of an integer type input (16 bits) into 16 bit type outputs.
	<b>Bin/Dec</b>	Make up of an integer type output (16 bits) from 16 bit type inputs.
	<b>SPLIT 16 bits to 4</b>	Split of a 16-bit word into four 16-bit words with values between 0 and 15.
	<b>SPLIT 16 bits to 2</b>	Split of a 16-bit word into two 16-bit words with values between 0 and 255.
	<b>Word Shift Register</b>	Shifting of the 16-bit words on each rising edge of the clock.
	<b>Shift Register</b>	Shifting of information by saving it to the memory (shifting of bits in a 16-bit word on each rising edge of the clock).
	<b>Transfer Function</b>	Table of correspondence between the X input and the Y output. The table of correspondence is created from a csv file
	<b>Transfer Function 50 values</b>	Table of correspondence between the X input and the Y output. The table of correspondence (50 rows max) is created from a sv file
	<b>Timer Transfer Function</b>	Correspondence table for the Minutes operating time and the Y output.
	<b>Timer Transfer Function 50 values</b>	Correspondence table for the Minutes operating time and the Y output. (50 Values)
PROG		
	<b>Hour Minute</b>	Indication of the time from the controller (hour and minutes).
	<b>Hr Mn Converter</b>	Conversion of a time period in the "hour : minute" format to minutes and vice versa.
	<b>Controller Status</b>	Access to the controller states and modify the behaviour of its FBD and/or SFC program depending on these states.
	<b>Summertime</b>	Active function throughout summer time, and inactive throughout winter time.
MACROS		
	<b>Display 15 texts</b>	Display of 15 texts one after each other with 15 Displays Function Blocs
	<b>Scroll 4 lines</b>	Scroll down of a text of four lines on the screen of the Controller
	<b>My Macro</b>	Possibility to create a personal macro library and to store them in the Macro tab.





**INPUTS/OUTPUTS**

	<b>Discrete Input</b>		<b>Integer Input</b>
	<b>Filtered Digital Input</b>		<b>Discrete Output</b>
	<b>Analog Input 0..10V</b>		<b>PWM Output</b>
	<b>Filtered Analog Input</b>		<b>Analog Output Expansions 10 bits</b>
	<b>Analog Input Expansion 10 bits</b>		<b>Integer Output</b>
	<b>Analog Input Expansion 12 bits</b>		











**HMI**

	<b>Display</b>		<b>B Button</b>
	<b>Text</b>		<b>ESC Button</b>
	<b>Menu Scroll</b>		<b>Minus Button</b>
	<b>LCD Backlight Output</b>		<b>Plus Button</b>
	<b>A Button</b>		<b>OK Button</b>





















**COMMUNICATION**

	<b>SL In</b>	Writing via serial link of data stored in the controller's fixed addresses
	<b>SL In S (saved)</b>	Data transmission via a programming port to memory space in the controller's fixed addresses. Data is protected in the event of disconnection of the controller
	<b>SL Out</b>	Reading via programming port of data stored in the controller's fixed addresses.
	<b>Alarm</b>	Control of 10 alarm levels and distribution of a serial data to a digital output, connected to a modern digital input. For example to send a SMS.
	<b>Message</b>	distribution of alarm messages to mobile phones, to the Millenium 3 Alarm tool or to e-mail addresses via the M3MOD













**GRAFSET SFC**

	<b>Resettable Initial Step</b>	When RESET function is activated, activation of the STEP OUTPUT for the function, which is the initial step, and reinitialization of all of the other active steps.
	<b>Initial Step</b>	Initial step of an SFC chart
	<b>Step</b>	A step of an SFC chart.
	<b>Or Divergence Step</b>	Transition of one step to be simultaneously made toward one or two steps.
	<b>Or Convergence</b>	Transition of one to four step(s) to be simultaneously made toward one step.
	<b>And Divergence</b>	Transition of one or two steps to be simultaneously made toward two steps.
	<b>And Convergence Step</b>	Transition of two steps to be simultaneously made toward one step.
	<b>Wait SFC Step</b>	Set up of a wait phase or step for a PLC or a device.
	<b>Move SFC Step</b>	Set up of a move step for a motor controlled by the PLC to a position specified on the TARGET input.
	<b>Motor Multiplexer</b>	Combination of the motor control signals produced by two linked MOVE SFC steps.

**CONTROL**

	<b>Timer</b>	Large set of timer functions (A/C, BW, B/H, Li/L, Totalizer)
	<b>Schmitt Trigger</b>	Monitoring of an analog value in relation to two thresholds.
	<b>Timer A</b>	Delay of actions for a predefined time.
	<b>Bistable</b>	Impulse relay function.
	<b>Set Reset</b>	Bistable memory - Priority assigned to either SET or RESET.
	<b>Timer Set Reset</b>	Trigger of operation of a particular device at a fixed time for a period set by the user.
	<b>One Second Clock</b>	The blinking input function is active every second.
	<b>Compare in Zone</b>	Comparison of a value between two setpoints (the MIN and MAX values determine the zone).
	<b>Compare</b>	Comparison of two analog values using the =, >, >=, <=, != operators.
	<b>MULTI COMPARE</b>	Activation of the output corresponding to the value present on the "Value" input.
	<b>HL Switch</b>	Comparison of a value against 5 thresholds.
	<b>Min Max</b>	Saving of the minimum and maximum values of a variable signal.
	<b>Reduced Average</b>	Update of the configured average of a number of values by deleting the minimum and maximum values.
	<b>Time Prog</b>	Daily, weekly, monthly and yearly time programmer.
	<b>Weekly Time Prog</b>	Daily, weekly, monthly and yearly time programmer.
	<b>Preset Counter</b>	Preset up/down counter
	<b>Up Down Counter</b>	External preset up/down counter.
	<b>Preset H Meter</b>	Preset hour counter (preselection of hour, minute).
	<b>High speed count</b>	Counting of the pulses arriving at the inputs of a controller powered by a DC supply at rates in excess of one pulse every 6 ms.
	<b>Fast count</b>	Counting of the pulses arriving at the input at rates in excess of one pulse every 10 ms.

**LOGIC**

	<b>Not</b>		<b>Or 6 Inputs</b>
	<b>And 2 Inputs</b>		<b>Nand 4 Inputs</b>
	<b>And 4 Inputs</b>		<b>Nor 4 Inputs</b>
	<b>And 6 Inputs</b>		<b>Xor 2 Inputs</b>
	<b>Or 2 Inputs</b>		<b>Boolean 6 Inputs/2 Outputs</b>
	<b>Or 4 Inputs</b>		<b>Boolean</b>

Function block marked in red:

	<b>CTN 1</b>	Available only for the Millenium 3 Smart Range
---	--------------	--

# A simple selection proo

## Crouzet Automation Logic Controllers, How to choose them?

### How many inputs and outputs do you need?

Inputs ..... (specify analog and digital inputs)

Outputs ..... (specify analog, digital and PWM outputs)

### Will you use:

#### Digital inputs

110-230 VAC

24 VAC

12 VDC

24 VDC

Encoder

Signal voltage: .....

Resolution: .....

Max. frequency: .....

#### Analog inputs

0-10 V

0-20 mA

Potentiometer

Temperature

NTC

Pt100

Pt1000

Thermocouple

Specify temperature range

Other

### What type of outputs do you require?

#### Digital outputs

Relays

Solid state

#### PWM outputs

Frequency and current: .....

#### Analog output

Voltage: .....

Max. current: .....

0-10 V

Other .....

### Do your Logic Controllers need to communicate with a network?

RS232 peer-to-peer connection (SLIn/SLOut protocol)

Modbus RS485 network connection

Ethernet network connection (Modbus TCP/IP)

Other .....

### Do you need to connect several Logic Controllers to each other's?

Number of Logic Controllers to connect to each other's within one application .....

### Does your application require:

**Direct current**

- 24 VDC                       12 VDC

**Alternating current**

- 24 VAC                       100-240 VAC

Does the Logic Controller need a display (on the product)?

- Yes                               No

### Do you need extension devices?

- Digital I/O – number of inputs and outputs: .....
- Analog I/O – number and type of inputs and outputs: .....
- Modem interface: .....
- GSM Modem                       STN Modem
- Other: .....

### Do you need accessories?

- External display
  - Remote LCD Display/keypad                       Touchscreen color
- Input signal converter – from to: .....
- Output signal converter – from to: .....
- Bluetooth® wireless interface for programming purpose or for access to a virtual display on a smartphone/a PC
- Power supply – max. output power: .....
- Other: .....

### Do you have specific application requirements?

- Vibration: .....                      Operating temperatures: .....
- Humidity: .....                      Degree of protection:.....
- Approval(s): .....

## Part number

Code	Description	Type	Page
79696030	Thermocouple probe J	Thermocouple/Pt100	62
79696031	Thermocouple probe J	Thermocouple/Pt100	62
79696032	Thermocouple probe J	Thermocouple/Pt100	62
79696033	Thermocouple probe J	Thermocouple/Pt100	62
79696034	Thermocouple probe K	Thermocouple/Pt100	62
79696035	Pt100 probe Class B	Thermocouple/Pt100	62
79696036	Pt100 probe Class B	Thermocouple/Pt100	62
79696037	Pt100 probe Class B	Thermocouple/Pt100	62
79696038	Connection	Accessory	62
79696039	Connection	Accessory	62
79696040	Connection	Accessory	62
79696041	Sub-base	Accessory	62
79696042	Flange	Accessory	62
88950105	PC: USB → DB9 (RS 232) link cable	PA	36
88950108	0-20 mA/0-10 V input converter	AC	65
88950109	External potentiometer for value adjustment	EP	66
88950112	PWM/0-10 V output converter	AC	65
88950150	Converter	AC	64
88950151	Converter	AC	64
88950152	Converter	AC	64
88950153	Converter	AC	64
88950154	Converter	AC	64
88950155	Converter	AC	64
88950302	Millenium power supply - Millenium range	PS	44
88950303	Millenium power supply - Millenium range	PS	44
88950304	Millenium power supply - Millenium range	PS	44
88950305	Millenium power supply - Millenium range	PS	44
88950306	Millenium power supply - Millenium range	PS	44
88950307	Millenium power supply - Millenium range	PS	44
88950320	DC/DC converters	PS	46
88950321	DC/DC converters	PS	46
88950400	Display with 4 x 14 mm red digits	RD	54
88970001	Bare board version	NB12	35
88970003	Bare board version	NB12	35
88970005	Bare board version	NB12	35
88970011	Bare board version	NB20	35
88970013	Bare board version	NB20	35
88970021	"Compact" range with display	CB12	21
88970031	"Compact" range with display	CB20	21
88970041	"Compact" range with display	CD12	21
88970042	"Compact" range with display	CD12	21
88970045	"Compact" range with display	CD12	21
88970051	"Compact" range with display	CD20	21
88970052	"Compact" range with display	CD20	21
88970055	"Compact" range with display	CD20	21
88970094	Standard Smart and Essential product kits	Kit 26	14
88970102	3 m serial programming cable: PC → Millenium 3	PA	15, 16, 17, 18, 19, 21, 35, 47, 52
88970104	Millenium 3 Bluetooth® interface	PA	15, 16, 17, 18, 19, 21, 35, 47, 48
88970108	EEPROM memory cartridge	PA	15, 16, 17, 18, 19, 21, 35, 47
88970109	USB programming cable 3 m: PC → Millenium 3	PA	15, 16, 17, 18, 19, 21, 35, 47, 48
88970111	Multilingual programming software	M3 Soft	15, 16, 17, 18, 19, 21, 35, 36, 47
88970116	Alarm management software	M3 ALARM	47, 55
88970117	Modem communication plug and play solutions	M3MOD	55
88970118	Modem communication plug and play solutions	RTC	55



## Part number

Code	Description	Type	Page
88970119	Modem communication plug and play solutions	GSM	55
88970123	1.80 m serial link cable: DB9 M/DB9 F	PA	36, 47, 52, 55
88970125	RJ45 tee-joint with 20 cm cable	Accessories	24
88970126	EOL ferrules	Accessories	24
88970127	RJ45 wiring kit	Accessories	24
88970131	Expandable range Essential	XB10	21
88970132	Expandable range Essential	XB10	21
88970141	Expandable range Essential	XD10	21
88970142	Expandable range Essential	XD10	21
88970151	Expandable range Essential	XD26	21
88970152	Expandable range Essential	XD26	21
88970155	Expandable range Essential	XD26	21
88970161	Expandable range Essential	XD26	21
88970162	Expandable range Essential	XD26	21
88970165	Expandable range Essential	XD26	21
88970211	Digital extension	XR06	26
88970213	Digital extension	XR06	26
88970214	Digital extension	XR06	26
88970215	Digital extension	XR06	26
88970221	Digital extension	XR10	26
88970223	Digital extension	XR10	26
88970224	Digital extension	XR10	26
88970225	Digital extension	XR10	26
88970231	Digital extension	XR14	26
88970233	Digital extension	XR14	26
88970234	Digital extension	XR14	26
88970235	Digital extension	XR14	26
88970241	Analog extension	XA04	28
88970270	Ethernet protocol TCP/IP Modbus extension	XN05	23
88970310	Removable connector kit for Millenium 3 CD12 or CB12	MA	47
88970311	Removable connector kit for Millenium 3 CD20 or CB20	MA	47
88970312	Removable connector kit for Millenium 3 XD26 or XB26	MA	47
88970313	Removable connector (spring cage) kit for NBR12, CD12 RBT	MA	19, 36, 47
88970314	Removable connector kit for NBR26	MA	36
88970315	Removable connector kit for NBR32	MA	36
88970316	Removable connector kit for NBR40	MA	36
88970317	Removable connector (spring cage) kit for XD26 RBT	MA	19, 47
88970321	Digital sandwich extension	XE10	26
88970323	Digital sandwich extension	XE10	26
88970324	Digital sandwich extension	XE10	26
88970410	Remote LCD screen/keypad	RD1	52
88970411	Remote LCD screen/keypad + 4 function keys + 4 LEDs	RD2	52
88970412	Kit with remote LCD screen/keypad + 3 m cable	RD1	52
88970413	Kit with remote LCD screen/keypad + 4 function keys + 4 LEDs + 3 m cable	RD2	52
88970414	IP65 protective membrane	MA	52
88970492	MTP6/50 user kit	RD	49
88970494	MTP8/50 user kit	RD	49
88970496	MTP8/70 user kit	RD	49
88970501	MTP6/50-MTP8/70 programming kit – USB-MiniUSB connection	PA	49, 49
88970502	MTP8/50-MTP8/70 programming kit - Ethernet crossover connection	PA	49
88970503	Modbus cable for MTP6/50 & MTP8/50	MA	49
88970504	Modbus cable for MTP8/70	MA	49
88970510	500 mm programming link cable Millenium 3 → DB9 M	PA	47
88970800	"Application-specific" analog termination extension	XA03	27
88970806	"Compact" range with display	CD20	21
88970808	Standard Smart and Essential product kits	Kit 20	14

## Part number

Code	Description	Type	Page
88970809	IP40 faceplate: CD12 or XD10	MA1	67
88970810	IP40 faceplate: CD20 or XD26		67
88970813	Standard Smart and Essential product kits	Kit 32	14
88970814	Expandable range Essential	XD26	21
88970825	Standard Smart and Essential product kits	Kit 16	14
88970840	"Compact" range with display	CB12	21
88970865	"Compact" range with display	CD12	21
88972250	Modbus RS-485 (slave) communication extension	XN06	23
88973001	Resin board version	NBR12	36
88973002	Resin board version	NBR12	36
88973061	Resin board version	NBR26	36
88973062	Resin board version	NBR26	36
88973211	Resin board version	NBR32	36
88973231	Resin board version	NBR40	36
88974021	Smart "Compact" range without display	CB12 Smart	16
88974023	Smart "Compact" range without display	CB12 Smart	16
88974024	Smart "Compact" range without display	CB12 Smart	16
88974026	Smart "Compact" range without display	CB12 Smart	16
88974031	Smart "Compact" range without display	CB20 Smart	16
88974033	Smart "Compact" range without display	CB20 Smart	16
88974034	Smart "Compact" range without display	CB20 Smart	16
88974041	Smart "Compact" range with display	CD12 Smart	15
88974042	Smart "Compact" range with display	CD12 Smart	15
88974043	Smart "Compact" range with display	CD12 Smart	15
88974044	Smart "Compact" range with display	CD12 Smart	15
88974045	Smart "Compact" range with display	CD12 Smart	15
88974046	Smart "Compact" range with display	CD12 Smart	15
88974051	Smart "Compact" range with display	CD20 Smart	15
88974052	Smart "Compact" range with display	CD20 Smart	15
88974053	Smart "Compact" range with display	CD20 Smart	15
88974054	Smart "Compact" range with display	CD20 Smart	15
88974055	Smart "Compact" range with display	CD20 Smart	15
88974080	Smart range starter kits	Kit 12	14
88974081	Smart range starter kits	Kit 12	14
88974082	Smart range starter kits	Kit 20	14
88974083	Smart range starter kits	Kit 20	14
88974084	Smart range starter kits	Kit 26	14
88974085	Smart range starter kits	Kit 26	14
88974106	Democase Millenium 3 Smart	DEMO	14
88974131	Smart "Expandable" range without display	XB10 Smart	18
88974132	Smart "Expandable" range without display	XB10 Smart	18
88974133	Smart "Expandable" range without display	XB10 Smart	18
88974134	Smart "Expandable" range without display	XB10 Smart	18
88974141	Smart "Expandable" range without display	XD10 Smart	17
88974142	Smart "Expandable" range without display	XD10 Smart	17
88974143	Smart "Expandable" range without display	XD10 Smart	17
88974144	Smart "Expandable" range without display	XD10 Smart	17
88974151	Smart "Expandable" range without display	XB26 Smart	18
88974152	Smart "Expandable" range without display	XB26 Smart	18
88974153	Smart "Expandable" range without display	XB26 Smart	18
88974154	Smart "Expandable" range without display	XB26 Smart	18
88974155	Smart "Expandable" range without display	XB26 Smart	18
88974161	Smart "Expandable" range without display	XD26 Smart	17
88974162	Smart "Expandable" range without display	XD26 Smart	17
88974163	Smart "Expandable" range without display	XD26 Smart	17
88974164	Smart "Expandable" range without display	XD26 Smart	17
88974165	Smart "Expandable" range without display	XD26 Smart	17

## Part number

Code	Description	Type	Page
<b>88974166</b>	Smart "Expandable" range without display	XD26 Smart	<b>17</b>
<b>88974250</b>	Master exchange unit for XN06	XN07	<b>24</b>
<b>88974441</b>	Smart range with Removable Terminal blocks	CD12 RBT Smart	<b>19</b>
<b>88974561</b>	Smart range with Removable Terminal blocks	XD26 RBT Smart	<b>19</b>
<b>89750147</b>	316 stainless steel protective sleeve	Accessories	<b>57, 60</b>
<b>89750150</b>	Zone/space	AS	<b>60</b>
<b>89750151</b>	Ventilation duct	AS	<b>60</b>
<b>89750152</b>	External	AS	<b>60</b>
<b>89750153</b>	Remote/submersible probe	AS	<b>60</b>
<b>89750160</b>	IP67 sealed faceplate for the following products : - XD10 or CD12	MA	<b>67</b>
<b>89750161</b>	IP67 sealed faceplate for the following products : - XD10 + XR06 or XN03 or XN05 or XA04 - CD20 or XD26 - XD10 + XN03 or XN05 + XR06 or XA04 - XD10 + XR10 or XR14	MA	<b>67</b>
<b>89750162</b>	IP67 sealed faceplate for the following products : - XD26 + XR06 or XN03 or XN05 or XA04 - XD10 + XN03 or XA04 + XR10 or XR14 - XD10 + XE10 + XR06 or XA04	MA	<b>67</b>
<b>89750174</b>	NTC2 probe PVC for Millenium 3	PVC	<b>57</b>
<b>89750180</b>	NTC1 probe (batch of 10) for Millenium 3	AS	<b>57</b>
<b>89750182</b>	NTC2 probe stainless 305 for Millenium 3	Stainless	<b>57</b>
<b>89750183</b>	Light sensor LDR for Millenium 3	AS	<b>59</b>
<b>89750185</b>	NTC2 probe silicone for Millenium 3 mini quantity 25 pieces	POM	<b>57</b>
<b>89750186</b>	NTC3 probe silicone for Millenium 3	Silicone	<b>57</b>

## AMERICAS

### CANADA

**InnoVista Sensors™**  
1461 Lawrence Drive  
Thousand Oaks, CA 91320  
USA  
Tel.: +1 (800) 677 5311  
Fax: +1 (800) 677 3865  
americas.custserv@crouzet.com

### MEXICO

**InnoVista Sensors™**  
Torre Platino, Blvd. Rodolfo Sanchez  
Taboada#10488, Zona Urbana Rio,  
Piso 9, C.P. 22010  
Tijuana, B.C., MEXICO  
Tel.: +1 (800) 677 5311  
Fax: +1 (800) 677 3865  
americas.custserv@crouzet.com

### USA

**InnoVista Sensors™**  
1461 Lawrence Drive  
Thousand Oaks, CA 91320  
USA  
Tel.: +1 (800) 677 5311  
Fax: +1 (800) 677 3865  
americas.custserv@crouzet.com

### COUNTRIES NOT LISTED

**InnoVista Sensors™**  
1461 Lawrence Drive  
Thousand Oaks, CA 91320  
USA  
Tel.: +1 (800) 677 5311  
Fax: +1 (800) 677 3865  
americas.custserv@crouzet.com

## EUROPE / MIDDLE EAST / AFRICA

### BELGIUM

**InnoVista Sensors™**  
Dieweg 3 B  
1180 Uccle - BELGIQUE  
Tel.: +32 (0) 2 462 07 30  
Fax: +32 (0) 2 461 00 23  
klantenservice@crouzet.com

### FRANCE

**InnoVista Sensors™**  
2 rue du Docteur Henri Abel,  
CS 60059  
26902 Valence Cedex 9  
FRANCE  
Tel.: +33 (0) 475 802 101  
Fax: +33 (0) 475 828 900  
relationclient@crouzet.com

### GERMANY / AUSTRIA

**InnoVista Sensors™**  
Otto-Hahn-Str. 3  
40721 Hilden  
DEUTSCHLAND  
Tel.: +49 (0) 2103/980-0  
Fax: +49 (0) 2103/980-222  
kundenservice@crouzet.com

### ITALY

**InnoVista Sensors™**  
Via Viganò De Vizzi, 93/95  
20092 Cinisello Balsamo (Mi)  
ITALIA  
Tel.: +39 (02) 66 599 211  
Fax: +39 (02) 66 599 218  
assistenzaclienti@crouzet.com

### SPAIN / PORTUGAL

**InnoVista Sensors™**  
C/Lleó, 11-13 2ªª  
08911 Badalona - Barcelona  
ESPAÑA  
Tel.: +34 (93) 484 39 70  
Fax: +34 (93) 484 39 73  
atencionalcliente@crouzet.com

### SWITZERLAND

**InnoVista Sensors™**  
Gewerbepark - Postfach 56  
5506 Mägenwil - SCHWEIZ  
Tel.: +49 (0) 2103/980-0  
Fax: +49 (0) 2103/980-222  
kundenservice@crouzet.com

### THE NETHERLANDS

**InnoVista Sensors™**  
Industrieweg 17  
2382 NR Zoeterwoude  
NEDERLAND  
Tel.: +31 (0) 71-581 20 30  
Fax: +31 (0) 71-541 35 74  
klantenservice@crouzet.com

### COUNTRIES NOT LISTED

**InnoVista Sensors™**  
2 rue du Docteur Henri Abel,  
CS 60059  
26902 Valence Cedex 9  
FRANCE  
Tel.: +33 (0) 475 802 102  
Fax: +33 (0) 475 828 900  
customer.relation@crouzet.com

## ASIA / PACIFIC

### CHINA

**InnoVista Sensors™**  
11<sup>th</sup> floor, Chang Feng  
International Tower,  
89 Yunling Road (East),  
Putuo District,  
Shanghai 200 062 - CHINA  
Tel.: +86 (21) 8025 7166  
Fax: +86 (21) 6107 1771  
china@crouzet.com

### INDIA

**InnoVista Sensors™**  
4<sup>th</sup> floor, Trident Towers, #23 100  
Feet Ashoka Pillar Road,  
2nd Block, Jaynagar  
Bangalore 560 011 - INDIA  
Tel.: +91 (80) 4113 2204/05  
Fax: +91 (80) 4113 2206  
india@crouzet.com

### SOUTH KOREA

**InnoVista Sensors™**  
14F, Kbiz DMC Tower,  
189, Seongam-Ro, Mapo-Gu,  
Seoul 121-904  
SOUTH KOREA  
Tel.: +82 (2) 2629 8312  
Fax: +82 (2) 2630 9800  
korea@crouzet.com

### EAST ASIA PACIFIC

**InnoVista Sensors™**  
10/F, Wharf T&T Centre, Harbour  
City, 7 Canton Road, Tsim Sha Tsui,  
Kowloon, HONG KONG  
Tel.: +86 (21) 8025 7177  
Fax: +86 (21) 6107 1771  
eap@crouzet.com

[WWW.CROUZET-AUTOMATION.COM](http://WWW.CROUZET-AUTOMATION.COM)



[WWW.INNOVISTASENSORS.COM](http://WWW.INNOVISTASENSORS.COM)



### Warning:

The product information contained in this catalogue is given purely as information and does not constitute a representation, warranty or any form of contractual commitment. Crouzet Automatismes SAS and its subsidiaries reserve the right to modify their products without notice. It is imperative that we should be consulted over any particular use or application of our products and it is the responsibility of the buyer to establish, particularly through all the appropriate tests, that the product is suitable for the use or application. Under no circumstances will our warranty apply, nor shall we be held responsible for any application (such as any modification, addition, deletion, use in conjunction with other electrical or electronic components, circuits or assemblies, or any other unsuitable material or substance) which has not been expressly agreed by us prior to the sale of our products.