

JUMO GmbH & Co. KG
 Delivery address: Mackenrodtstraße 14,
 36039 Fulda, Germany
 Postal address: 36035 Fulda, Germany
 Phone: +49 661 6003-0
 Fax: +49 661 6003-607
 E-mail: mail@jumo.net
 Internet: www.jumo.net

JUMO Instrument Co. Ltd.
 JUMO House
 Temple Bank, Riverway
 Harlow - Essex CM20 2DY, UK
 Phone: +44 1279 63 55 33
 Fax: +44 1279 63 52 62
 E-mail: sales@jumo.co.uk
 Internet: www.jumo.co.uk

JUMO Process Control, Inc.
 8 Technology Boulevard
 Canastota, NY 13032, USA
 Phone: 315-697-JUMO
 1-800-554-JUMO
 Fax: 315-697-5867
 E-mail: info@jumo.us
 Internet: www.jumo.us



JUMO heatTHERM-AT and heatTHERM-DR

Type 603070, design as add-on or room thermostat

Particularities

- **PUSH IN**®-Connection technology - **reduced installation time by 50%**
- Stable switch point position due to ambient temperature compensation (serial)
- Max. contact rating 16 A, 230 V
- Tested as per DIN EN 14597
- Service life, at least 250,000 switching cycles for TR and TW
- Switch point deviation during the entire service life of max. $\pm 5\%$
- Protection class max. IP 54
- UL approval (extra code 061)

Brief description

High application flexibility and latest connection technology are the essential equipment features of this new thermostat series.

The thermostat case is suitable for all common installation types such as wall mounting, immersion sleeve and contact fastening. It can be used universally and reduces the variant range because different mounting types must no longer be taken into account.

The heatTHERM-DR (design 7+8) type is a specific variation with a special housing bottom section for top hat rail or wall mounting. This allows an easy mounting on support rails TH35 as per DIN EN 60715 (e.g. in switch cabinets). This variant considerably reduces the mounting time. The flue gas temperature monitor heatTHERM-AT locks the gas/oil vessel connected in parallel with the wood vessel to a chimney.

For these worldwide innovative add-on thermostats with "Push-In"® terminal technology, the connection wires are only inserted into the terminal point up to the stop - done! No tool is required for connecting the wire or braid with ferrule and the wiring will become more safely. In this manner, the costs and time required for connection is considerably reduced compared that of the conventional screw terminal.

The "Push-In"® terminal technology allows direct switching of loads up to 16A at 230V AC. The installation costs can be reduced further because a contactor is no longer required.

The maintenance costs are reduced by the small distance of approx. 10K between switch-off point and re-switch-on point of the safety temperature limiter.

Available are temperature controllers (TR), temperature monitors (TW), safety temperature monitors (STW), safety temperature limiters (STB) as single or double thermostats and flue gas temperature monitors (ATW).

Approval as per DIN EN 14 597, DGRL and UL indicate the high quality standards valid for this product series.



Type 603070/0170 (TR/STB)



Type 603070/0001 (TR)



Type 603070/0002 (TW)



Type 603070/0002 (TW)

Approval/approval marks (see Technical Data)



DGRL
97/23/EG



Design 5+6*



Design 7+8*

*only with
extra code
061

JUMO GmbH & Co. KG
 Delivery address: Mackenrodtstraße 14,
 36039 Fulda, Germany
 Postal address: 36035 Fulda, Germany
 Phone: +49 661 6003-0
 Fax: +49 661 6003-607
 E-mail: mail@jumo.net
 Internet: www.jumo.net

JUMO Instrument Co. Ltd.
 JUMO House
 Temple Bank, Riverway
 Harlow - Essex CM20 2DY, UK
 Phone: +44 1279 63 55 33
 Fax: +44 1279 63 52 62
 E-mail: sales@jumo.co.uk
 Internet: www.jumo.co.uk

JUMO Process Control, Inc.
 8 Technology Boulevard
 Canastota, NY 13032, USA
 Phone: 315-697-JUMO
 1-800-554-JUMO
 Fax: 315-697-5867
 E-mail: info@jumo.us
 Internet: www.jumo.us



Technical Data

Switching function

Temperature controller TR / temperature monitor TW	If the temperature exceeds the set point value set on the temperature probe, the micro switch will be tripped via the transmission mechanics and the current circuit opened or closed. The micro switch is reset to its original status once the set point value set is gone below (by the hysteresis).
Safety temperature monitor STW	If the temperature exceeds the set point value set on the temperature probe, the snap switch will be tripped and the current circuit opened or closed. The snap switch is reset to its original status once the set point value set is gone below (by the hysteresis). If the measuring system is destroyed, i.e. if the expansion fluid emerges, the pressure in the diaphragm drops and permanently opens the current circuit. If the probe has cooled down to a temperature below approx. -20°C, the same current circuit opens, however, automatically closes again, when the temperature rises.
Safety temperature limiter STB	If the temperature exceeds the switching point set on the temperature probe, the snap switch is tripped, the current circuit opened or closed and the snap switch mechanically locked. The snap switch can be manually unlocked again once the switching point temperature has gone below by approx. 10K. If the measuring system is destroyed, i.e. if the expansion fluid emerges, the pressure in the diaphragm drops and permanently opens the control current circuit. Unlocking is no longer possible. If the probe has cooled down to a temperature below approx. -20°C, the control current circuit opens, however, automatically closes again, when the temperature rises.

Temperature compensation

When the ambient temperature on the switch head and the long-distance line deviates from the calibration ambient temperature +22°C, a switch point offset occurs. This switching point offset is minimized due to the temperature compensation.

JUMO GmbH & Co. KG
 Delivery address: Mackenrodtstraße 14,
 36039 Fulda, Germany
 Postal address: 36035 Fulda, Germany
 Phone: +49 661 6003-0
 Fax: +49 661 6003-607
 E-mail: mail@jumo.net
 Internet: www.jumo.net

JUMO Instrument Co. Ltd.
 JUMO House
 Temple Bank, Riverway
 Harlow - Essex CM20 2DY, UK
 Phone: +44 1279 63 55 33
 Fax: +44 1279 63 52 62
 E-mail: sales@jumo.co.uk
 Internet: www.jumo.co.uk

JUMO Process Control, Inc.
 8 Technology Boulevard
 Canastota, NY 13032, USA
 Phone: 315-697-JUMO
 1-800-554-JUMO
 Fax: 315-697-5867
 E-mail: info@jumo.us
 Internet: www.jumo.us



Technical Data

Case

	Design 5 + 6	Design 7 + 8
Case	Housing bottom section: Color: Silver gray RAL 7001 (for TZ 061 black) Case lid: ABS with inspection window (PMMA) Color: cobalt blue RAL 5013 (for TZ 061 light gray, RAL 7035)	PA (inforced) Color: Silver gray RAL 7001 (for TZ 061 black)
Set point value setting	TR The switching point can be externally adjusted by means of the rotary knob TW, STW, STB, ATW The switching point can be adjusted by means of a screwdriver once the case lid has been removed, check the set switching point through the inspection glass.	- - Switching point can adjusted by means of a screwdriver
Protection type	IP 54 as per EN 60 529	IP 20 as per EN 60 529
Cable inlet	Cable screw connection M20 x 1.5, for cable \varnothing 6-12 mm	Cable connection directly on PUSH IN terminals
Long-distance line	\varnothing 1.5 mm - min. bending radius of the long-distance line 5 mm - material: Copper (Cu) or stainless steel (CrNi, 1.4301)	
Case fastening	Pipe mounting with clamping belt for pipe diameter 15-100 mm, sheath mounting, wall mounting	Wall mounting, top hat rail installation TH35 as per DIN EN 60715
Weight	approx. 0.2 kg	

Electrical data

Electric contact	Snap switch with single-pole change-over contact	
Contact rating	TR / TW / STW / ATW On the N/C contact (Contact deck 1-2): AC 230 V +10%, 16 (2.5) A, $\cos \varphi = 1$ (0.6), DC 230 V +10%, 0.25 A On the N/O contact (Contact deck 1-4): AC 230 V +10%, 6,3 (2.5) A, $\cos \varphi = 1$ (0.6), DC 230 V +10%, 0.25 A	STB On the N/C contact (Contact deck 1-2): AC 230 V +10%, 16 (2.5) A, $\cos \varphi = 1$ (0.6), DC 230 V +10%, 0.25 A On the signal contact (Contact deck 1-4): AC 230 V +10%, 2 (04) A, $\cos \varphi = 1$ (0.6), DC 230 V +10%, 0.25 A
Electrical connection	PUSH IN contact (plug-type terminal) „Push-In [®] “-terminal technology: patented connection technology of Weidmüller GmbH & Co. KG, Detmold	
Connection cross section	0.75...2.5 mm ² fine wired (single-wire, fine wired with ferrule)	
Switching reliability	To ensure a high switching reliability, we recommend a minimum load of: AC / DC = 24 V, 100 mA with silver contacts AC / DC = 10 V, 5 mA with gold-plated contacts (TZ 702)	

JUMO GmbH & Co. KG
 Delivery address: Mackenrodtstraße 14,
 36039 Fulda, Germany
 Postal address: 36035 Fulda, Germany
 Phone: +49 661 6003-0
 Fax: +49 661 6003-607
 E-mail: mail@jumo.net
 Internet: www.jumo.net

JUMO Instrument Co. Ltd.
 JUMO House
 Temple Bank, Riverway
 Harlow - Essex CM20 2DY, UK
 Phone: +44 1279 63 55 33
 Fax: +44 1279 63 52 62
 E-mail: sales@jumo.co.uk
 Internet: www.jumo.co.uk

JUMO Process Control, Inc.
 8 Technology Boulevard
 Canastota, NY 13032, USA
 Phone: 315-697-JUMO
 1-800-554-JUMO
 Fax: 315-697-5867
 E-mail: info@jumo.us
 Internet: www.jumo.us



Operating data

Switching point accuracy	TR, TW	STW, STB with a setting range of:			
		+20°C...+80°C		+70°C...+130°C	
	Hysteresis 2.5%	in the "first half" (+20°C...+50°C)	in the "second half" (+50°C...+80°C)	in the "first half" (+70°C...+100°C)	in the "second half" (+100°C...+130°C)
	In the upper third of the scale $\pm 3\%$, at scale beginning $\pm 6\%$	+0/-8 K	+0/-5 K	+0/-12 K	+0/-5 K
Temperature compensation	When the ambient temperature on the switch head and the long-distance line deviates from the calibration ambient temperature +22°C, a switch point offset of approx. -0.1 K/K occurs (switch point change referring to the ambient temperature change, measured at limit value +120°C permanently set and long-distance line length 2000 mm). This switching point offset is minimized due to the series temperature compensation.				
Limit value temperatures	for transport and storage: -30°C...+50°C				
	during use: max. +80°C, for TZ 061 UL approval max. +65°C (design 7 max. 55°C; design 6+8 max. +50°C)				
	for pipe mounting: max. pipe temperature +120°C				
Rated position	as per DIN 16257, NL 0...NL 90 (different rated positions on request)				

Approval/approval marks

Approval marks	Inspection authority	Inspection basics	valid for
DIN	DIN CERTCO	DIN EN 14597	TR 119107, TW 119207, STW (STB) 119307, STB 119407, ATW 1218
DGRL	TÜV Süd (German Technical Inspection Agency)	Directive governing pressure systems 97/23/EC	STW and STB
UL	UL Germany	UL 873	E 66358

Wiring diagrams

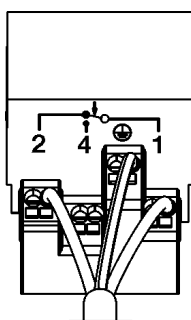

TR, TW, STW

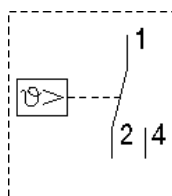

STB

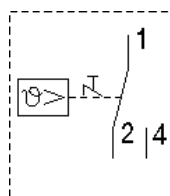

JUMO GmbH & Co. KG
 Delivery address: Mackenrodtstraße 14,
 36039 Fulda, Germany
 Postal address: 36035 Fulda, Germany
 Phone: +49 661 6003-0
 Fax: +49 661 6003-607
 E-mail: mail@jumo.net
 Internet: www.jumo.net

JUMO Instrument Co. Ltd.
 JUMO House
 Temple Bank, Riverway
 Harlow - Essex CM20 2DY, UK
 Phone: +44 1279 63 55 33
 Fax: +44 1279 63 52 62
 E-mail: sales@jumo.co.uk
 Internet: www.jumo.co.uk

JUMO Process Control, Inc.
 8 Technology Boulevard
 Canastota, NY 13032, USA
 Phone: 315-697-JUMO
 1-800-554-JUMO
 Fax: 315-697-5867
 E-mail: info@jumo.us
 Internet: www.jumo.us



Devices in stock: JUMO heatTHERM-AT

Temperature controller TR, design 5

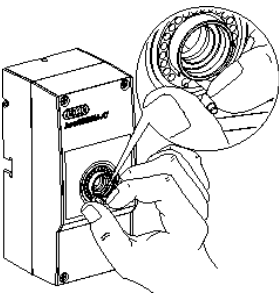
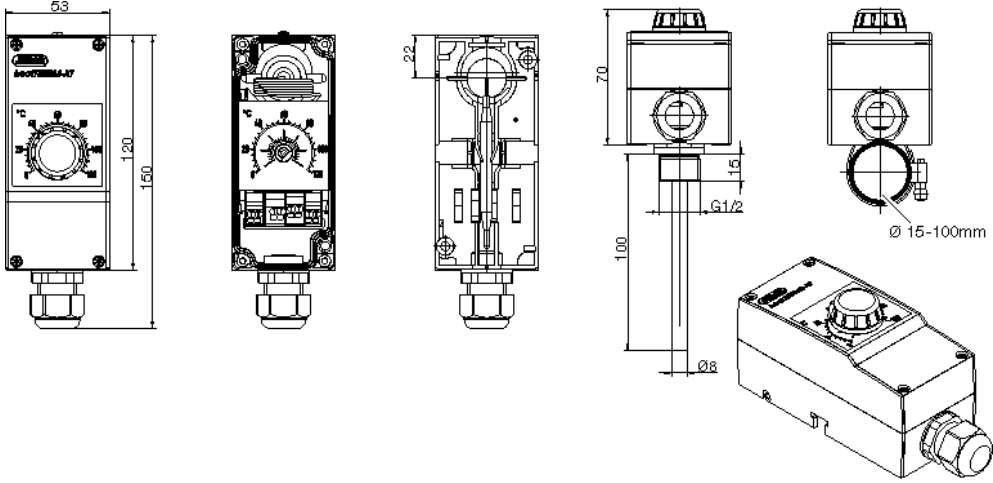
Type 603070/0001^a <ul style="list-style-type: none"> Protection class IP 54 Compensation of the ambient temperature Individual limitation of the control range 						
Part No.	Type	Control range °C	Long-distance line mm	Probe-Ø (d) x L mm	Hysteresis	Process connection
60/60003185	heatTHERM-AT/0001	0...+120	2000	6 x 87	approx. 3K	with internal long-distance line and contact probe
60/60003186						Sheath U 4, brass nickel-plated

^a Further design versions (control range, hysteresis, process connection) on request - Minimum order quantity 100 pieces. Sheaths, page 15.

Temperature monitor TW

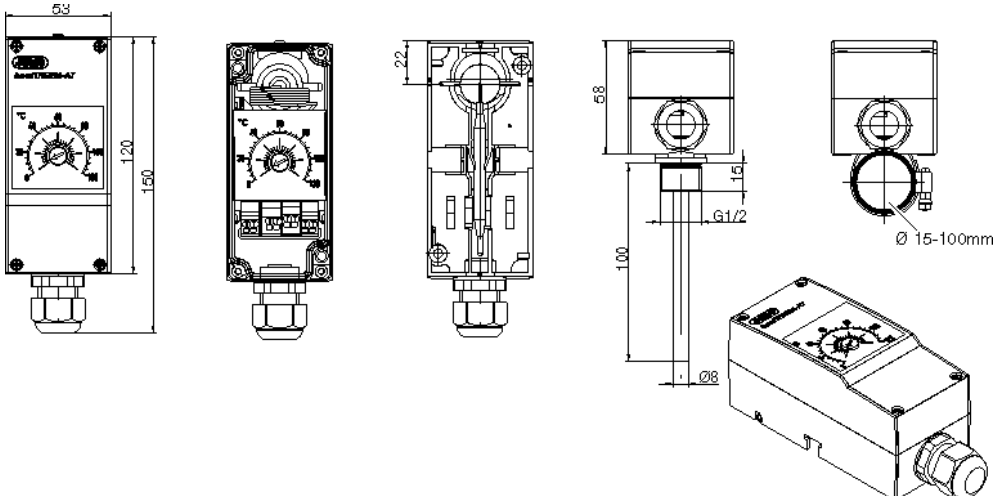
Type 603070/0002^a <ul style="list-style-type: none"> Protection class IP 54 Compensation of the ambient temperature Switching value control through inspection windows in the housing lid 						
Part No.	Type	Control range °C	Long-distance line mm	Probe-Ø (d) x L mm	Hysteresis	Process connection
60/60003187	heatTHERM-AT/0002	0...+120	2000	6 x 87	approx. 3K	with internal long-distance line and contact probe
60/60003188						Sheath U 4, brass nickel-plated

^a Further design versions (control range, hysteresis, process connection) on request - Minimum order quantity 100 pieces. Sheaths, page 15.

JUMO GmbH & Co. KG
 Delivery address: Mackenrodtstraße 14,
 36039 Fulda, Germany
 Postal address: 36035 Fulda, Germany
 Phone: +49 661 6003-0
 Fax: +49 661 6003-607
 E-mail: mail@jumo.net
 Internet: www.jumo.net

JUMO Instrument Co. Ltd.
 JUMO House
 Temple Bank, Riverway
 Harlow - Essex CM20 2DY, UK
 Phone: +44 1279 63 55 33
 Fax: +44 1279 63 52 62
 E-mail: sales@jumo.co.uk
 Internet: www.jumo.co.uk

JUMO Process Control, Inc.
 8 Technology Boulevard
 Canastota, NY 13032, USA
 Phone: 315-697-JUMO
 1-800-554-JUMO
 Fax: 315-697-5867
 E-mail: info@jumo.us
 Internet: www.jumo.us



Devices in stock: JUMO heatTHERM-AT

Safety temperature monitor STW, design 5

Type 603070/0020^a <ul style="list-style-type: none"> Protection class IP 54 Switching value control through inspection windows in the housing lid Compensation of the ambient temperature Later lead sealing of the case lid is possible Capillary break protection 						
Part No.	Type	Control range °C	Long-distance line mm	Probe-Ø (d) x L mm	Hysteresis	Process connection
60/60003229	heatTHERM-AT/0020	+20...+80	2000	6 x 60	approx. 10K	with internal long-distance line and contact probe
60/60003189		+70...+130				Sheath U 4, brass nickel-plated

^a Further design versions (control range, hysteresis, process connection) on request - Minimum order quantity 100 pieces. Sheaths, page 15.

Safety temperature limiter STB, design 5

Type 603070/0070^a <ul style="list-style-type: none"> Protection class IP 54 Switching value control through inspection windows in the housing lid External acknowledgement of the switching point is possible Compensation of the ambient temperature Later lead sealing of the case lid is possible Capillary break protection 						
Part No.	Type	Control range °C	Long-distance line mm	Probe-Ø (d) x L mm	Hysteresis	Process connection
60/60003230	heatTHERM-AT/0070	+70...+130	2000	6 x 60	approx. 10K	with internal long-distance line and contact probe
60/60003190						Sheath U 4, brass nickel-plated

^a Further design versions (control range, hysteresis, process connection) on request - Minimum order quantity 100 pieces. Sheaths, page 15.

JUMO GmbH & Co. KG
 Delivery address: Mackenrodtstraße 14,
 36039 Fulda, Germany
 Postal address: 36035 Fulda, Germany
 Phone: +49 661 6003-0
 Fax: +49 661 6003-607
 E-mail: mail@jumo.net
 Internet: www.jumo.net

JUMO Instrument Co. Ltd.
 JUMO House
 Temple Bank, Riverway
 Harlow - Essex CM20 2DY, UK
 Phone: +44 1279 63 55 33
 Fax: +44 1279 63 52 62
 E-mail: sales@jumo.co.uk
 Internet: www.jumo.co.uk

JUMO Process Control, Inc.
 8 Technology Boulevard
 Canastota, NY 13032, USA
 Phone: 315-697-JUMO
 1-800-554-JUMO
 Fax: 315-697-5867
 E-mail: info@jumo.us
 Internet: www.jumo.us



Devices in stock: JUMO heatTHERM-AT

Room thermostat temperature controller TR, design 6

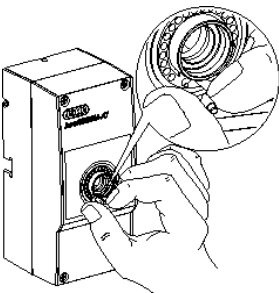
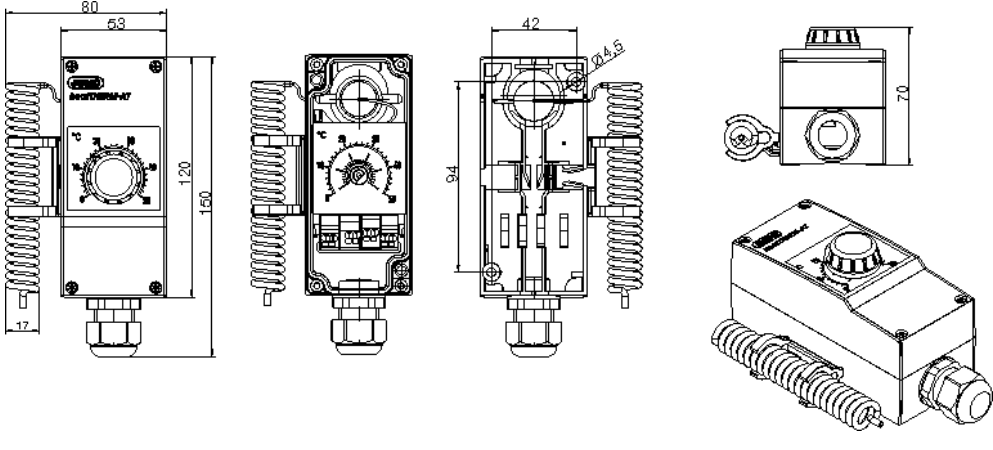
Type 603070/0001^a <ul style="list-style-type: none"> Protection class IP 54 Wall mounting Individual limitation of the control range 						
Part No.	Type	Control range °C	Long-distance line mm	Probe-Ø (d) x L mm	Hysteresis	Process connection
60/60003191	heatTHERM-AT/0001	-10...+40	--	--	1.5 - 2K	Spiral probe
60/60003192		0...+50				

^a Further design versions (control range, hysteresis, process connection) on request - Minimum order quantity 100 pieces. Sheaths, page 15.

Room thermostat temperature monitor TW, design 6

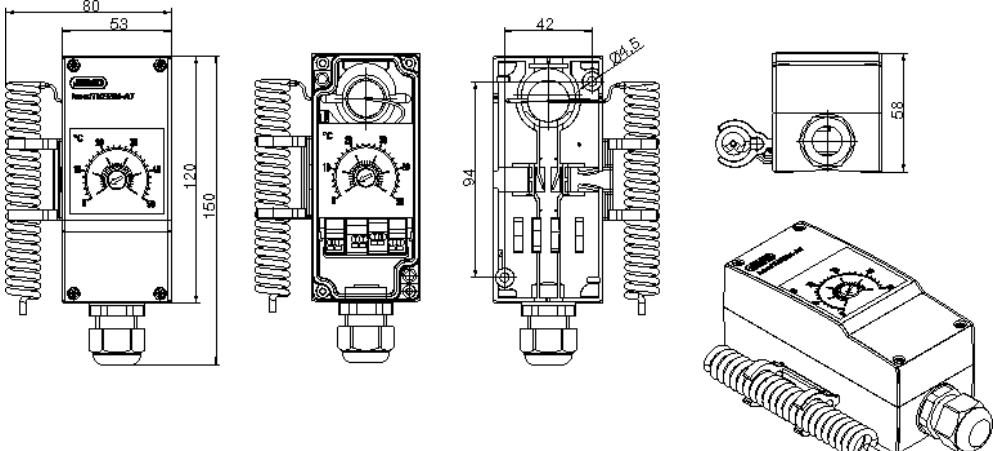
Type 603070/0002^a <ul style="list-style-type: none"> Protection class IP 54 Wall mounting Switching value control through inspection windows in the housing lid 						
Part No.	Type	Control range °C	Long-distance line mm	Probe-Ø (d) x L mm	Hysteresis	Process connection
60/60003193	heatTHERM-AT/0002	-10...+40	--	--	1.5 - 2K	Spiral probe
60/60003194		0...+50				

^a Further design versions (control range, hysteresis, process connection) on request - Minimum order quantity 100 pieces. Sheaths, page 15.

JUMO GmbH & Co. KG
 Delivery address: Mackenrodtstraße 14,
 36039 Fulda, Germany
 Postal address: 36035 Fulda, Germany
 Phone: +49 661 6003-0
 Fax: +49 661 6003-607
 E-mail: mail@jumo.net
 Internet: www.jumo.net

JUMO Instrument Co. Ltd.
 JUMO House
 Temple Bank, Riverway
 Harlow - Essex CM20 2DY, UK
 Phone: +44 1279 63 55 33
 Fax: +44 1279 63 52 62
 E-mail: sales@jumo.co.uk
 Internet: www.jumo.co.uk

JUMO Process Control, Inc.
 8 Technology Boulevard
 Canastota, NY 13032, USA
 Phone: 315-697-JUMO
 1-800-554-JUMO
 Fax: 315-697-5867
 E-mail: info@jumo.us
 Internet: www.jumo.us



Devices in stock: JUMO heatTHERM-AT

Temperature controller/safety temperature monitor TR/STW, design 5

Type 603070/0120^a <ul style="list-style-type: none"> Protection class IP 54 Switching value control through inspection windows in the housing lid Compensation of the ambient temperature Capillary break protection for STW 						
Part No.	Type	Control range °C	Long-distance line mm	Probe-∅ (d) x L mm	Hysteresis	Process connection
60/60003195	heatTHERM-AT/0120	TR: 0...+120	2000	6 x 87	approx. 3K	with internal long-distance line and contact probe
		STW: 70...+130		6 x 60	approx. 10K	
60/60003231		TR: 0...+120		6 x 87	approx. 3K	Sheath; brass nickel-plated
		STW: 70...+130		6 x 60	approx. 10K	

^a Further design versions (control range, hysteresis, process connection) on request - Minimum order quantity 100 pieces. Sheaths, page 15.

Temperature controller/safety temperature limiter TR/STB, design 5

Type 603070/0170^a <ul style="list-style-type: none"> Protection class IP 54 Switching value control through inspection windows in the housing lid Compensation of the ambient temperature Capillary break protection for STW 						
Part No.	Type	Control range °C	Long-distance line mm	Probe-∅ (d) x L mm	Hysteresis	Process connection
60/60003196	heatTHERM-AT/0170	TR: 0...+120	2000	6 x 87	approx. 3K	with internal long-distance line and contact probe
		STB: 70...+130		6 x 60	approx. 10K	
60/60003232		TR: 0...+120		6 x 87	approx. 3K	Sheath; brass nickel-plated
		STB: 70...+130		6 x 60	approx. 10K	

^a Further design versions (control range, hysteresis, process connection) on request - Minimum order quantity 100 pieces. Sheaths, page 15.

JUMO GmbH & Co. KG
 Delivery address: Mackenrodtstraße 14,
 36039 Fulda, Germany
 Postal address: 36035 Fulda, Germany
 Phone: +49 661 6003-0
 Fax: +49 661 6003-607
 E-mail: mail@jumo.net
 Internet: www.jumo.net

JUMO Instrument Co. Ltd.
 JUMO House
 Temple Bank, Riverway
 Harlow - Essex CM20 2DY, UK
 Phone: +44 1279 63 55 33
 Fax: +44 1279 63 52 62
 E-mail: sales@jumo.co.uk
 Internet: www.jumo.co.uk

JUMO Process Control, Inc.
 8 Technology Boulevard
 Canastota, NY 13032, USA
 Phone: 315-697-JUMO
 1-800-554-JUMO
 Fax: 315-697-5867
 E-mail: info@jumo.us
 Internet: www.jumo.us



Devices in stock: JUMO heatTHERM-AT

Room thermostat temperature monitor / temperature monitor TW/TW, design 6

Type 603070/0202^a <ul style="list-style-type: none"> Protection class IP 54 Wall mounting Switching value control through inspection windows in the housing lid 						
Part No.	Type	Control range °C	Long-distance line mm	Probe-Ø (d) x L mm	Hysteresis	Process connection
60/60003212	heatTHERM-AT/0202	-10...+40	--	--	1.5 - 2K	Spiral probe
60/60003213		0...+50				

^a Further design versions (control range, hysteresis, process connection) on request - Minimum order quantity 100 pieces. Sheaths, page 15.

Flue gas temperature monitor with flange sleeve, design 5

Type 603070/0020^a <ul style="list-style-type: none"> Switching value control through inspection windows in the housing lid Compensation of the ambient temperature max. admissible probe temperature +400°C Approval as ATW with capillary break protection as per DIN 14597 Time constant $t_{0.632} \leq 45$ sec in flue gas 						
Part No.	Type	Control range °C	Long-distance line mm	Probe-Ø (d) x L mm	Hysteresis	Process connection
60/60003307	heatTHERM-AT/0002	+40...+230	--	--	approx. 15K	Sheath with flange and intermediate piece

^a Further design versions (control range, hysteresis, process connection) on request - Minimum order quantity 100 pieces. Sheaths, page 15.

JUMO GmbH & Co. KG
 Delivery address: Mackenrodtstraße 14,
 36039 Fulda, Germany
 Postal address: 36035 Fulda, Germany
 Phone: +49 661 6003-0
 Fax: +49 661 6003-607
 E-mail: mail@jumo.net
 Internet: www.jumo.net

JUMO Instrument Co. Ltd.
 JUMO House
 Temple Bank, Riverway
 Harlow - Essex CM20 2DY, UK
 Phone: +44 1279 63 55 33
 Fax: +44 1279 63 52 62
 E-mail: sales@jumo.co.uk
 Internet: www.jumo.co.uk

JUMO Process Control, Inc.
 8 Technology Boulevard
 Canastota, NY 13032, USA
 Phone: 315-697-JUMO
 1-800-554-JUMO
 Fax: 315-697-5867
 E-mail: info@jumo.us
 Internet: www.jumo.us



Devices in stock: JUMO heatTHERM-DR

Thermostat for top hat rail installation TH35, as per DIN EN 60715, design 7

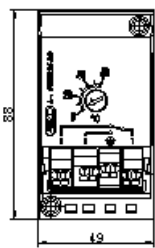
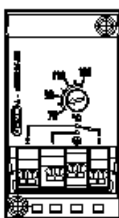
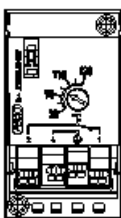
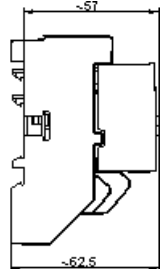
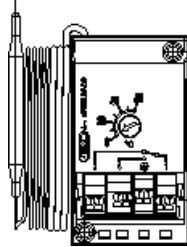
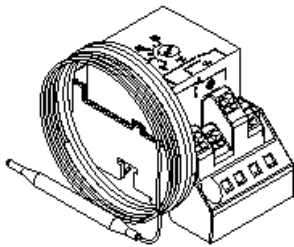
Type 603070/. . . .^a <ul style="list-style-type: none"> Protection class IP 54 Top hat rail installation TH35 Installation and user friendly 		603070/0002-7 		603070/0020-7 		603070/0070-7 		
								
Part No.	Type	Control range °C	Long-distance line mm	Probe-Ø (d) x L mm	Hysteresis	Process connection		
Temperature monitor TW								
60/60003283	603070/0002	0...+120	2000	6 x 87	approx. 3K	with long-distance line and contact probe		
60/60003284	603070/0002	0...+200		6 x 78	approx. 5K			
60/60003285	603070/0002	+50...+300		6 x 66	approx. 6K			
Safety temperature monitor STW								
60/60003286	603070/0020	+70...+130	2000	6 x 60	approx. 10K	with long-distance line and contact probe		
Safety temperature limiter STB					Unlocking difference			
60/60003287	603070/0070	+70...+130	2000	6 x 60	approx. 10K	with long-distance line and contact probe		
60/60003299	603070/0070	+20...+150		6 x 63				
60/60003300	603070/0070	+50...+300		6 x 63				

^a Further design versions (control range, hysteresis, process connection) on request - Minimum order quantity 100 pieces. Sheaths, page 15.

JUMO GmbH & Co. KG
 Delivery address: Mackenrodtstraße 14,
 36039 Fulda, Germany
 Postal address: 36035 Fulda, Germany
 Phone: +49 661 6003-0
 Fax: +49 661 6003-607
 E-mail: mail@jumo.net
 Internet: www.jumo.net

JUMO Instrument Co. Ltd.
 JUMO House
 Temple Bank, Riverway
 Harlow - Essex CM20 2DY, UK
 Phone: +44 1279 63 55 33
 Fax: +44 1279 63 52 62
 E-mail: sales@jumo.co.uk
 Internet: www.jumo.co.uk

JUMO Process Control, Inc.
 8 Technology Boulevard
 Canastota, NY 13032, USA
 Phone: 315-697-JUMO
 1-800-554-JUMO
 Fax: 315-697-5867
 E-mail: info@jumo.us
 Internet: www.jumo.us



JUMO heatTHERM-DR

Thermostat for top hat rail installation TH35, as per DIN EN 60715, design 8

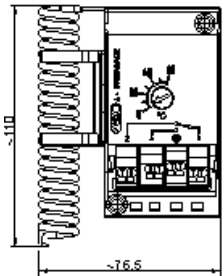
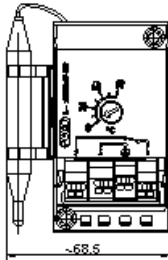
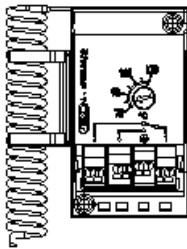
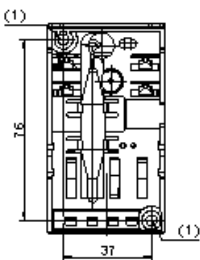
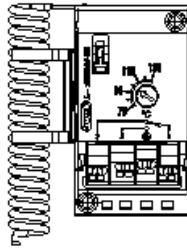
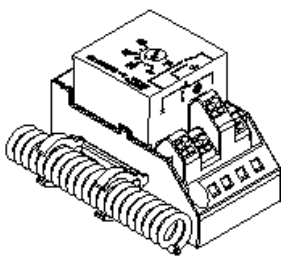
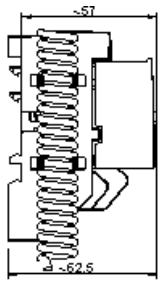
<p>Type 603070/0002-8^a</p> <ul style="list-style-type: none"> • Protection class IP 20 • Top hat rail installation TH35 • Installation and user friendly <p>Fastening hole (1) = Ø 4.5 mm</p>	<p>603070/0002-8</p>  	<p>603070/0020-8</p>  	<p>603070/0070-8</p>  	
--	---	---	---	---

^a On request - minimum order quantity 100 pieces.

JUMO GmbH & Co. KG
 Delivery address: Mackenrodtstraße 14,
 36039 Fulda, Germany
 Postal address: 36035 Fulda, Germany
 Phone: +49 661 6003-0
 Fax: +49 661 6003-607
 E-mail: mail@jumo.net
 Internet: www.jumo.net

JUMO Instrument Co. Ltd.
 JUMO House
 Temple Bank, Riverway
 Harlow - Essex CM20 2DY, UK
 Phone: +44 1279 63 55 33
 Fax: +44 1279 63 52 62
 E-mail: sales@jumo.co.uk
 Internet: www.jumo.co.uk





JUMO Process Control, Inc.
 8 Technology Boulevard
 Canastota, NY 13032, USA
 Phone: 315-697-JUMO
 1-800-554-JUMO
 Fax: 315-697-5867
 E-mail: info@jumo.us
 Internet: www.jumo.us



Order details

Add-on thermostat JUMO heatTHERM, type 603070

Minimum purchase order 100 pieces

Order code	(1)	Basic type	
603070		JUMO heatTHERM with single-pole snap switch	
	(2)	Basic type extensions	
0001		Temperature controller (TR)	
0002		Temperature monitor (TW)	
0020		Safety temperature monitor (STW) or flue gas temperature monitor (ATW)	
0070		Safety temperature limiter (STB)	
0120		Temperature controller / safety temperature monitor (TR/STW)	
0170		Temperature controller / safety temperature limiter (TR/STB)	
0202		Temperature monitor / temperature monitor (TW/TW)	
	(3)	Design	
5		Add-on thermostat, with sheath, flange sleeve, long-distance line or as contact probe	
6		Room thermostat with spiral probe	
7		Top hat rail thermostat, with long-distance line	
8		Top hat rail thermostat, with spiral probe	
	(4)	Control / limit value range 1 [°C]	
016		-10...+40	TR, TW
021		0...+50	TR, TW
026		0...+120	TR, TW
028		0...+200	TR, TW, STB
040		+20...+80	STW
043		+20...+150	TR, TW, STB
064		+50...+300	TR, TW, STB with sheath, select process connection 76
671		+70...+130	STW, STB
380		+40...+230	ATW only with process connection 35
		further control/limit value ranges up to 350°C on request (up to +500°C without approval)	
	(5)	Control / limit value range 2 [°C]	
000		with permanently set limit value (single thermostat)	
016		-10...+40	TR, TW adjustable
021		0...+50	TR, TW adjustable
671		+70...+130	STW, STB adjustable
		further control/limit values permanently set up to 350°C on request (up to +500°C without approval)	

JUMO GmbH & Co. KG
 Delivery address: Mackenrodtstraße 14,
 36039 Fulda, Germany
 Postal address: 36035 Fulda, Germany
 Phone: +49 661 6003-0
 Fax: +49 661 6003-607
 E-mail: mail@jumo.net
 Internet: www.jumo.net





JUMO Instrument Co. Ltd.
 JUMO House
 Temple Bank, Riverway
 Harlow - Essex CM20 2DY, UK
 Phone: +44 1279 63 55 33
 Fax: +44 1279 63 52 62
 E-mail: sales@jumo.co.uk
 Internet: www.jumo.co.uk

JUMO Process Control, Inc.
 8 Technology Boulevard
 Canastota, NY 13032, USA
 Phone: 315-697-JUMO
 1-800-554-JUMO
 Fax: 315-697-5867
 E-mail: info@jumo.us
 Internet: www.jumo.us

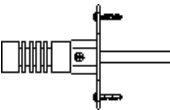

Order details

Add-on thermostat JUMO heatTHERM, type 603070

Order code	(6)	Hysteresis 1	
00		Without hysteresis (STB)	
25		2.5%	of the scale range
70		7%	of the scale range
	(7)	Hysteresis 2	
00		Without hysteresis (STB)	
25		2.5%	of the scale range
70		7%	of the scale range
	(8)	Long-distance line length 1	
0		0 mm	only for room thermostat
2000		2000 mm	
			Special length on request
	(9)	Long-distance line length 2	
0		0 mm	only for room thermostat
2000		2000 mm	
			Special length on request
	(10)	Material of long-distance line 1	
00		without long-distance line	
20		CrNi	Stainless steel
40		Cu	Copper
	(11)	Material of long-distance line 2	
00		without long-distance line	Single thermostat
20		CrNi	Stainless steel
40		Cu	Copper
	(12)	Process connection	
10		plain cylindrical probe / contact probe	
15		Spiral probe	
35		Sheath for heatTHERM with flange and intermediate piece	
76 ^a		Intermediate piece	

^a for process connection 76, please select sheath as per data sheet 60.6710, screw-in sheath U with thread G1/2 made of stainless steel (CrNi) additionally.

JUMO GmbH & Co. KG
 Delivery address: Mackenrodtstraße 14,
 36039 Fulda, Germany
 Postal address: 36035 Fulda, Germany
 Phone: +49 661 6003-0
 Fax: +49 661 6003-607
 E-mail: mail@jumo.net
 Internet: www.jumo.net

JUMO Instrument Co. Ltd.
 JUMO House
 Temple Bank, Riverway
 Harlow - Essex CM20 2DY, UK
 Phone: +44 1279 63 55 33
 Fax: +44 1279 63 52 62
 E-mail: sales@jumo.co.uk
 Internet: www.jumo.co.uk

JUMO Process Control, Inc.
 8 Technology Boulevard
 Canastota, NY 13032, USA
 Phone: 315-697-JUMO
 1-800-554-JUMO
 Fax: 315-697-5867
 E-mail: info@jumo.us
 Internet: www.jumo.us



Order details

Add-on thermostat JUMO heatTHERM, type 603070

Order code	(13)	Diameter (probe diameter)
6		∅ 6 mm
17		∅ 17 mm Spiral probe for room thermostat (with process connection 15)
3.5		∅ 3.5 mm (with process connection 35)
	(14)	Long-distance line insulation
13		PVC hose, black
	(15)	Insulation length (from housing)
460		460 mm Special length on request
	(16)	Probe material 1
20		CrNi Stainless steel
40		Cu Copper
	(17)	Probe material 2
00		Single thermostat
20		CrNi Stainless steel
40		Cu Copper
	(18)	Extra codes^a
000		Without extra codes
402		Housing protection type IP54
749		Setting range with 250 angular degrees (only STB/STW)
758		Clamping belt for contact probe
061		with UL approval
702		Snap switch, gold-plated

^a State extra codes one after another, separated by commas.

Order code

(1) (2) (3) (4) (5) (6) (7) (8) (9) (10) (11) (12) (13) (14) (15) (16) (17) (18)
 6073070 / [] - [] - [] - [] - [] - [] - [] - [] - [] - [] - [] - [] - [] - [] - [] - [] - [] / [] , ...

Order example

603070 / 0001 - 5 - 021 - 671 - 70 - 2000 - 40 - 10 - 00 - 00 - 00 - 00 - 6 - 00 - 00 - 6 / 000^a , ...

^a State extra codes one after another, separated by commas.





JUMO GmbH & Co. KG
 Delivery address: Mackenrodtstraße 14,
 36039 Fulda, Germany
 Postal address: 36035 Fulda, Germany
 Phone: +49 661 6003-0
 Fax: +49 661 6003-607
 E-mail: mail@jumo.net
 Internet: www.jumo.net

JUMO Instrument Co. Ltd.
 JUMO House
 Temple Bank, Riverway
 Harlow - Essex CM20 2DY, UK
 Phone: +44 1279 63 55 33
 Fax: +44 1279 63 52 62
 E-mail: sales@jumo.co.uk
 Internet: www.jumo.co.uk



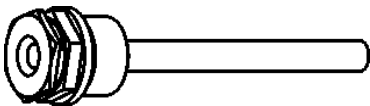

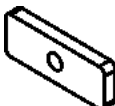
JUMO Process Control, Inc.
 8 Technology Boulevard
 Canastota, NY 13032, USA
 Phone: 315-697-JUMO
 1-800-554-JUMO
 Fax: 315-697-5867
 E-mail: info@jumo.us
 Internet: www.jumo.us





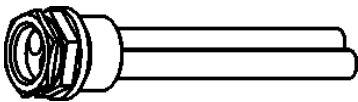

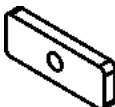
Accessories

Sheath set	Sheaths with sealing collar			Clamp for strain relief	Disk for add-on thermostat	Screw for add-on thermostat
suitable for 1 probe						

Part No.	Type	Abbreviation	Connection	∅ sleeve x fitting length EL	Material	Compressive strength at +150°C
60/60003177	Sheath for heatTHERM, 1 probe	28	G 1/2	8 x 100 mm	Brass / nickel-plated	48 bar
60/60003203				8 x 150 mm		
60/60003171				8 x 200 mm		
60/60003172	Sheath for heatTHERM, 1 probe	28	G 1/2	8 x 100 mm	Stainless steel / 1.4571	88 bar
60/60003205				8 x 150 mm		
60/60003173				8 x 200 mm		

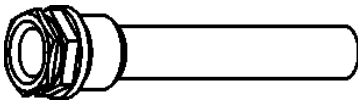
Sheath set	Sheaths with sealing collar			Clamp for strain relief	Disk for add-on thermostat	Screw for add-on thermostat
suitable for 2 probes						

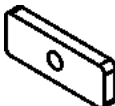
Part No.	Type	Abbreviation	Connection	∅ sleeve x fitting length EL	Material	Compressive strength at +150°C
60/60003178	Sheath for heatTHERM, 2 probes	29	G 1/2	2 x 8 x 100 mm	Brass / nickel-plated	48 bar
60/60003204				2 x 8 x 150 mm		
60/60003174				2 x 8 x 200 mm		

Sheath set	Sheaths with sealing collar			Pressure spring	Clamp for strain relief	Disk for add-on thermostat	Screw for add-on thermostat
suitable for 2 probes							

Part No.	Type	Abbreviation	Connection	∅ sleeve x fitting length EL	Material	Compressive strength at +150°C
60/60003175	Sheath for heatTHERM, 2 probes	29	G 1/2	15 x 100 mm	Stainless steel / 1.4571	48 bar
60/60003206				15 x 150 mm		
60/60003176				15 x 200 mm		

Adapter piece for sheath					Material	
Part No.					Steel / nickel-plated	
60/60507273						