



Read this document carefully before using this device. The guarantee will be expired by device damages if you don't attend to the directions in the user manual. Also we don't accept any compensations for personal injury, material damage or capital disadvantages.

## ENDA ET2412 ON/OFF HEAT CONTROLLER

Thank you for choosing ENDA ET2412 ON/OFF Heat Controller.

- ▶ 77 x 35mm sized.
- ▶ Single NTC sensor input.
- ▶ Zero point input shift.
- ▶ Selectable heating or cooling control for C1 relay output.
- ▶ A1 Relay output for alarm control.
- ▶ Selectable independent, deviation and band alarm types.
- ▶ In the case of sensor failure, relay state can be set to ON or OFF.
- ▶ Upper and lower setpoint limits can be adjusted.
- ▶ Temperature unit can be selected as °C or °F.
- ▶ CE marked according to European Norms.



**RoHS**  
Compliant

Order Code : ET2412 -	1	2	1 - Supply Voltage	2 - Relay Current Selection
	1	2		
			230.....230V AC	08.....8A Relay Output
			110.....110V AC	
			024.....24V AC/DC	
			012.....12V AC/DC	
			SM.....7-24VAC/9-30VDC	

### CONNECTION DIAGRAM



ENDA ET2412 is intended for installation within control panels. Make sure that the device is used only for intended purpose. The shielding must be grounded on the instrument side. During an installation, all of the cables that are connected to the device must be free of electrical power. The device must be protected against inadmissible humidity, vibrations, severe soiling. Make sure that the operation temperature is not exceeded.

All input and output lines that are not connected to the supply network must be laid out as shielded and twisted cables. These cables should not be close to the power cables or components. The installation and electrical connections must be carried out by a qualified staff and must be according to the relevant locally applicable regulations.

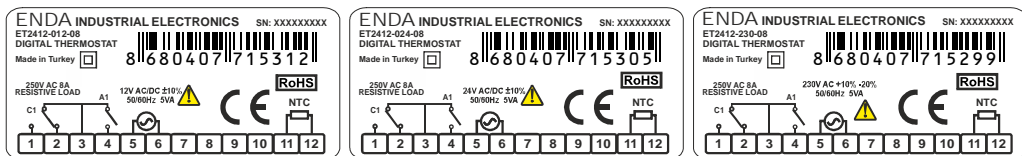

Equipment is protected throughout by **DOUBLE INSULATION**

Holding screw **0.4-0.5Nm.**

#### NOTE:

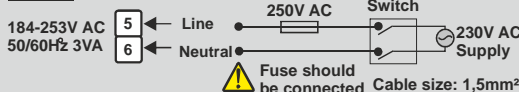

#### Note:

- 1) Mains supply cords shall meet the requirements of IEC 60227 or IEC 60245.
- 2) In accordance with the safety regulations, the power supply switch shall bring the identification of the relevant instrument and it should be easily accessible by the operator.

up to date: 25.03.2019, modification reserved and can be change any time previous notice !

**SURAN** Industrieelektronik  
Dettinger Str. 9  
D-72160 Horb a.N.

Tel.: +49 (0)7451 / 625 617  
Fax: +49 (0)7451 / 625 0650

E-mail : info@suran-elektronik.de  
Internet : www.suran-elektronik.de

## TECHNICAL SPECIFICATIONS

INPUT		
Input Type	Scale Range	Accuracy
NTC Sensor Resistance	EN 60751	-60.0...150.0 °C -76.0...302.0°F
± 1% (for full scale) ± 1 Digit		
ENVIRONMENTAL CONDITIONS		
Ambient/Storage temperature	0 ... +50 / °C -25... +70 °C(without icing)	
Relative Humidity	Max. humidity 80% for temperatures up to 31°C decreasing linearly to 50% relative humidity at 40°C.	
Protection Class	According to EN60529; Front panel: IP65 Rear panel : IP20	
Height	Max. 2000mm	
⚠ Do not use the device in locations subject to corrosive and flammable gasses.		
ELECTRICAL CHARACTERISTICS		
Supply	230V AC +%-10 -%20, 50/60Hz or 12/24V AC/DC ±%10	
Power Consumption	Max. 3VA	
Wiring	Power connector : 2.5mm² screw-terminal, Signal connector : 1,5mm² screw-terminal conenction.	
Line Resistance	Max. 100ohm	
Data Retention	EEPROM (Min. 10 years)	
EMC	EN 61326-1: 2013 (Performance criterion B is satisfied for EN 61000-4-3)	
Safety Requirements	EN 61010-1: 2010 (Pollution degree 2, overvoltage category II)	
Indicator	4 digits, 12,5mm, 7 segment red LED	

OUTPUT	
C1 Output	250V AC, 8A (resistive load), NO and NC control output.
A1 Output	250V AC, 8A (resistive load), NO control output.
Life Expectancy for Relay	30. Mio. Switching for no-load operation; 300.000 switching for 8A resistive load at 250VAC.

CONTROL	
Control Type	Single-setpoint and alarm control.
Control Algorithm	<b>On-Off Control.</b>
A/D Converter	12 bit resolution, 100ms sampling time.
Hysteresis	Adjustable between 0.1 and 20.0°C/F.

HOUSING	
Housing Type	Suitable for flush-panel mounting according to DIN 43 700.
Dimensions	W77xH35xD61mm
Weight	Approx. 215g (After packing)
Enclosure Materials	Self extinguishing plastics

⚠ While cleaning the device, solvents (thinner, benzine, acid etc.) or corrosive materials must not be used.

### Dimensions



For removing mounting clamps:

- Push the flush-mounting clamp in direction 1 as shown in the figure below. Then, pull out the clamp in direction 2.

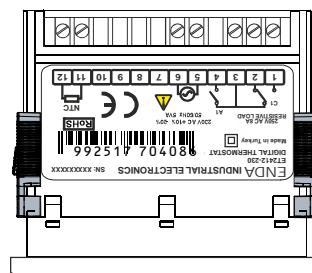
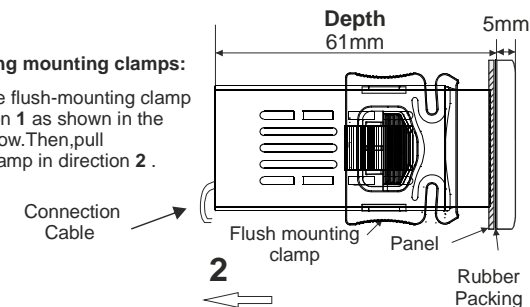

Flush mounting clamp

Panel cut-out 71,5mm

1

2

29,5mm

- Note:**
- 1) Panel thickness should be maximum 7mm.
  - 2) If there is not 60mm free space at the back side of the device, it would be difficult to remove it from the panel.

# Programming Diagram

## Running Mode

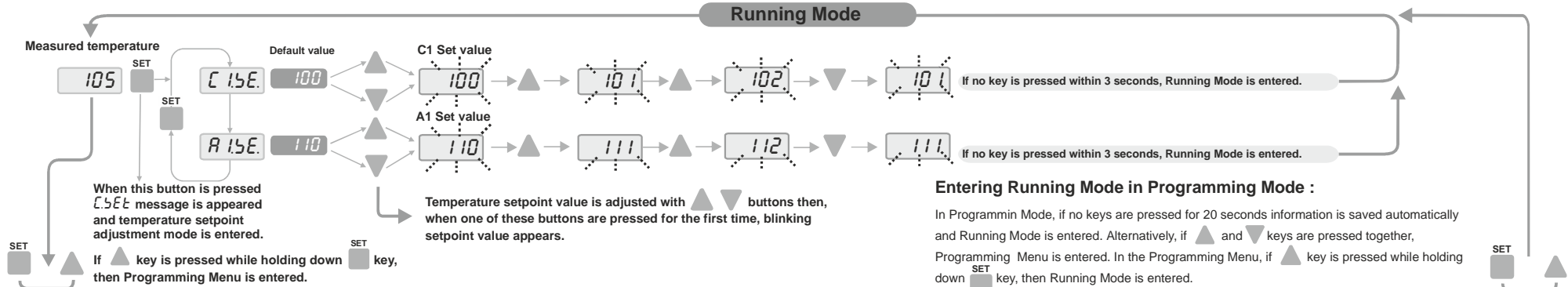

## Programming Menu

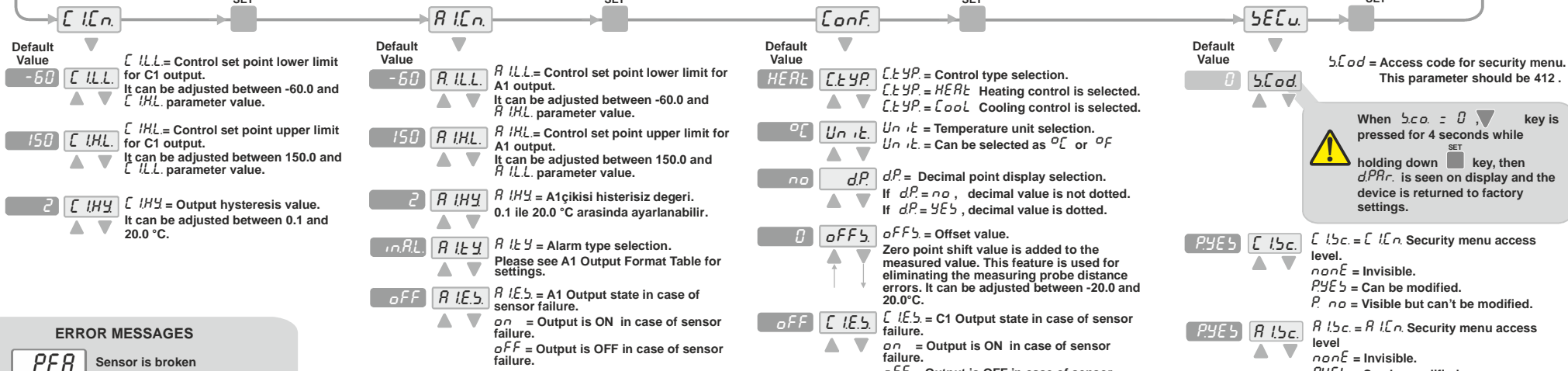

### ERROR MESSAGES

- P.F.F.** Sensor is broken
- Temperature value is higher than the scale
- Temperature value is lower than the scale

### Modification of Parameter Diagram

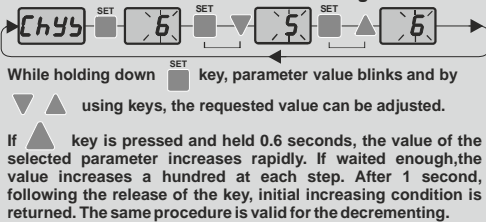

### A1 OUTPUT FORMATS

#### Independent Alarm

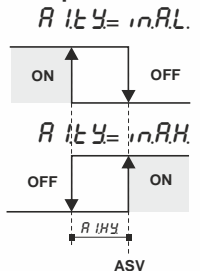

#### Deviation Alarm

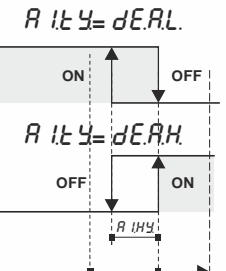

#### Band Alarm

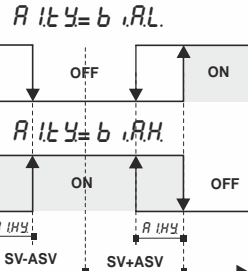

(ASV Min. = Beginning of Scale  
ASV Max. = End of Scale)

(ASV Min. = -300, ASV Max. = +300)

SV = C1 output setpoint ASV = A1 output setpoint  
(ASV Min. = 0, ASV Max. = +300)