

REFERENCIA REFERENCE NUMBER REFERENZNUMMERN	TENSIÓN NOMINAL NOMINAL VOLTAGE TENSION NOMINALE NENNSPANNUNG	PAR NOMINAL NOMINAL TORQUE COUPLE NOMINAL DREHMOMENT NOMINAL	VELOCIDAD NOMINAL NOMINAL SPEED VITESSE NOMINALE GESCHWINDIGKEIT NOMINAL	CORRIENTE NOMINAL NOMINAL CURRENT COURANT NOMINAL NOMINALSTROM	PAR DE ARRANQUE STARTING TORQUE COUPLE DE DÉMARRAGE ANZUGSDREHMOMENT	CORRIENTE DE ARRANQUE STARTING CURRENT COURANT DE DÉMARRAGE ANLAUFSTROM	EJE SHAFT ARBRE WELLE	CONEXIONES CONNECTIONS CONNEXIONS ANSCHLUSSART	ESQUEMA ELÉCTRICO WIRING DIAGRAM SCHEMA ÉLECTRIQUE SCHALTBILD	RELACIÓN DE REDUCCIÓN TRANSMISSION RATIO RAPPORT DE RÉDUCTEUR UNTERSEITZUNG	PESO APROXIMADO APPROXIMATE WEIGHT POIDS APPROXIMATIF GEWICHT (ca.)	GRADO DE ESTANQUEIDAD WATERTIGHTNESS ÉTANCHÉITÉ FEUCHTIGKEITSSCHUTZKLASSE	MATERIAL RUEDA WHEEL MATERIAL MATERIAU ROUE MAT. DES SCHNECKENRADES	CURVA CURVE COURBE KURVE
	Un (V)	Mn (N.m./lbf.in)	n <sub>n</sub> (r.p.m.)	In (A)	Ma (N.m./lbf.in)	Ia (A)				i	P (kg/lb.t)	IP		
316.2711.20.00	12	2 / 17.70	38	3.4	10 / 88.5	12	E22	C30	EE4	62:1	0.90/2.41	IP40	PLA	56
316.2711.30.00	24	2 / 17.70	38	1.7	10 / 88.5	6	E22	C30	EE4	62:1	0.90/2.41	IP40	PLA	56
316.2761.20.00	12	2 / 17.70	38	3.4	10 / 88.5	12	E30	C30	EE4	62:1	0.90/2.41	IP40	PLA	56
316.2761.30.00	24	2 / 17.70	38	1.7	10 / 88.5	6	E30	C30	EE4	62:1	0.90/2.41	IP40	PLA	56
316.2761.20.00E	12	2 / 17.70	38	3.4	10 / 88.5	12	E30	C30	F4	62:1	0.90/2.41	IP40	PLA	56
316.2761.30.00E	24	2 / 17.70	38	1.7	10 / 88.5	6	E30	C30	F4	62:1	0.90/2.41	IP40	PLA	56
316.9728.30.00	24	2 / 17.70	38	1.7	10 / 88.5	6	E30	C30	EE4	62:1	0.90/2.41	IP40	BRO	56
316.9731.20.00	12	*1.5/13.27	65	6.0	10 / 88.5	22	E30	C30	EE4	62:1	0.90/2.41	IP40	PLA	57
316.9731.30.00	24	*1.5/13.27	65	3.0	10 / 88.5	11	E30	C30	EE4	62:1	0.90/2.41	IP40	PLA	57

\* (VDE 0530) S3 - 10% (10 min.)

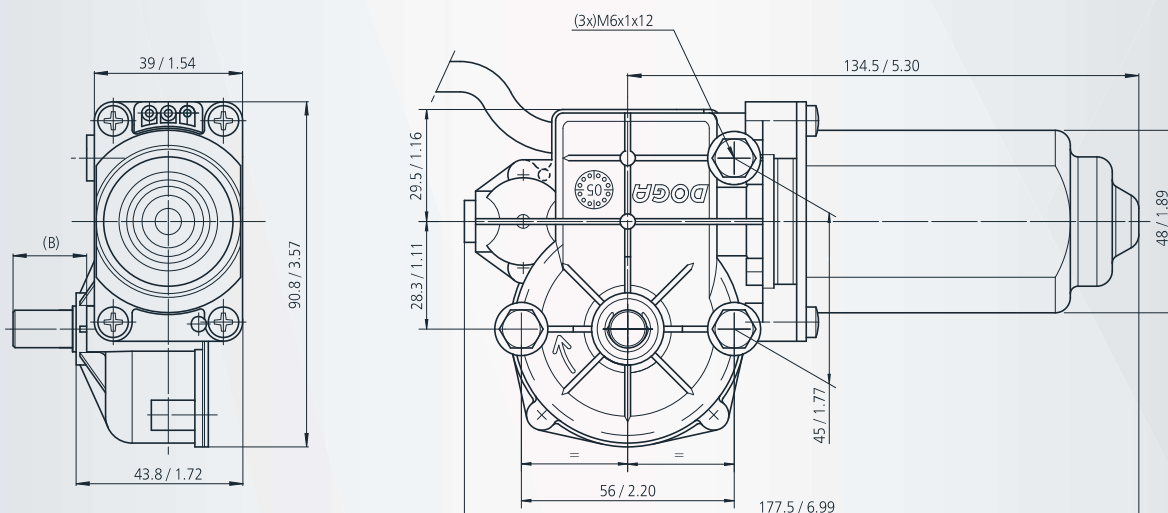

mm / inch

EJE **SHAFT** ARBRE **WELLE**

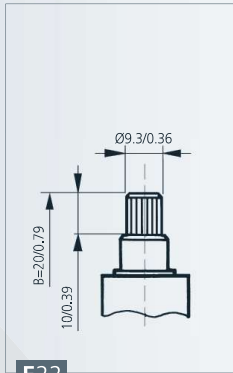

**E22**

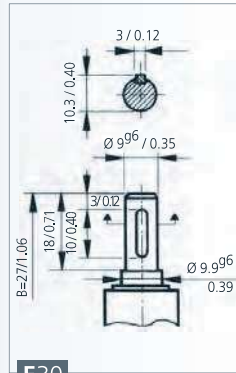

**E30**

CONEXIONES **CONNECTIONS** CONNEXIONS **ANSCHLUSSART**

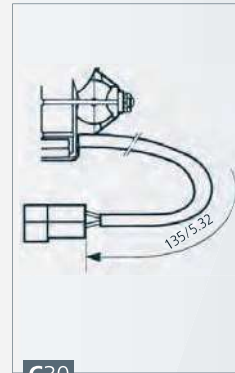

**C30**

ESQUEMA ELÉCTRICO **WIRING DIAGRAM** SCHÉMA ÉLECTRIQUE **SCHALTBILD**

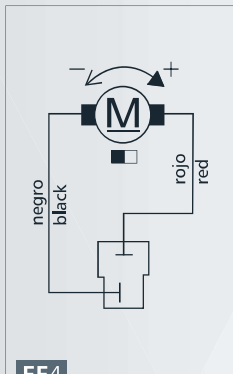

**EE4**

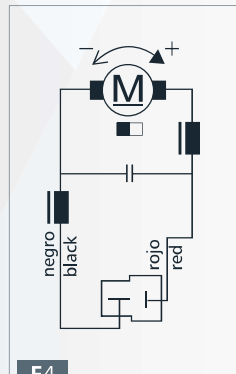

**F4**

CURVAS **CURVES** COURBES **KURVEN**

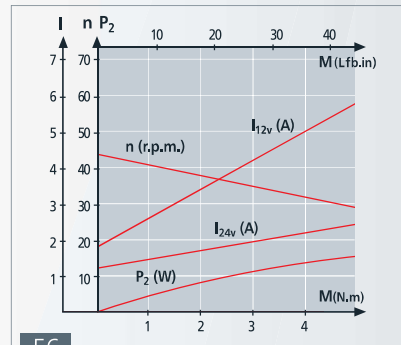

**56**

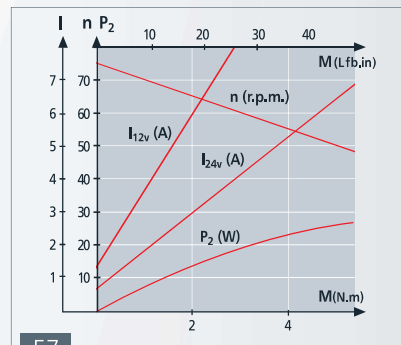

**57**