

Ethernet Switch – Premium Line

IE-SW-PL18M Series (Managed)

Hardware Installation Guide

Fourth Edition, October 2012
1243410000/03/10.12

Please note:

This document, the **detailed manual** and any further product information - if available - can be downloaded at the internet link:

<http://www.weidmueller.com/downloads>

Copyright Notice

Copyright © 2012 Weidmüller Interface GmbH & Co. KG
All rights reserved.
Reproduction without permission is prohibited.

Weidmüller 

Package Checklist

Your Ethernet Switch is shipped with the following items. If any of these items are missing or damaged, please contact your Weidmüller customer service for assistance.

- 1 Ethernet Switch IE-SW-PL18M
- Hardware Installation Guide
- CD-ROM with User's Manual and Windows Utility (option)
→ **Please download CD-ROM from Internet page**
<http://www.weidmueller.com/downloads>
- RJ45 to DB9 Console port cable
- Protective caps for unused ports

Optional Accessories

- **SFP-Transceiver** (Fast Ethernet and Gigabit Ethernet modules for different transmission lengths)
 - **RM-KIT (19" rack mounting kit)**
- More detailed information in datasheet

Panel Views of IE-SW-PL18M-2GC-16TX

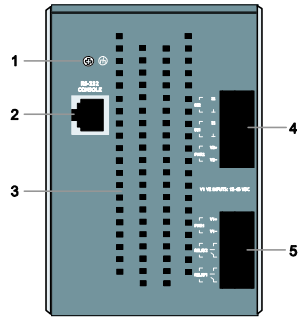

1. Grounding screw
2. Console port
3. Heat dissipation orifices
4. 6-pin terminal block for DI 1, DI 2, and PWR 2
5. 6-pin terminal block for PWR1 Relay 1, and Relay 2

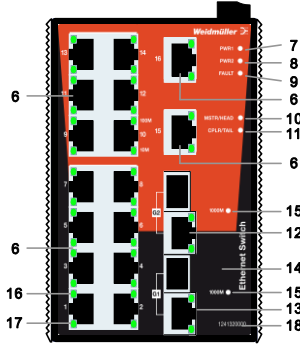

6. 10/100BaseT(X), ports 1 to 16
7. PWR 1: LED for power input 1
8. PWR 2: LED for power input 2
9. Fault LED
10. MSTR/HEAD LED
11. CPLR/TAIL LED
12. 10/100/1000BaseT(X), port G2
13. 10/100/1000BaseT(X), port G1
14. Label
15. 1000 Mbps LEDs
16. TP port's 100 Mbps LED
17. TP port's 10 Mbps LED
18. Article Number
19. Screw hole for Wall Mounting Kit
20. DIN-Rail Kit

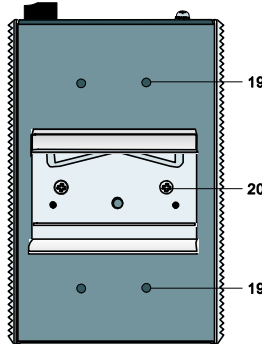

**Panel Views of models
IE-SW-PL18M-2GC-14TX2ST
IE-SW-PL18M-2GC-14TX2SC
IE-SW-PL18M-2GC-14TX2SCS**

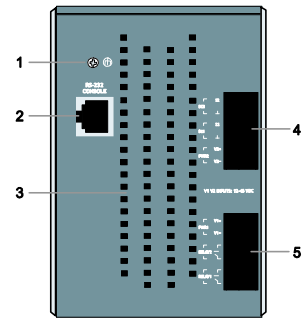

NOTE:

The appearance of models
IE-SW-PL18M-2GC14TX2SCS,
IE-SW-PL18M-2GC14TX2SC and
IE-SW-PL18M-2GC14TX2ST are -
apart from the optical connectors -
identical.

1. Grounding screw
2. Console port
3. Heat dissipation orifices
4. 6-pin terminal block for DI 1, DI 2, and PWR 2
5. 6-pin terminal block for PWR1 Relay 1, and Relay 2
6. 10/100BaseT(X), ports 1 to 14
7. PWR 1: LED for power input 1
8. PWR 2: LED for power input 2
9. Fault LED
10. MSTR/HEAD LED
11. CPLR/TAIL LED
12. 10/100/1000BaseT(X) Port G2
13. 10/100/1000BaseT(X) Port G1
14. Label
15. 1000 Mbps LEDs
16. TP port's 100 Mbps LED
17. TP port's 10 Mbps LED
18. Article Number
19. 100BaseFX Port 16
20. 100BaseFX Port 15
21. 100BaseFX LEDs
22. Screw hole for Wall Mounting Kit
23. DIN-Rail Kit

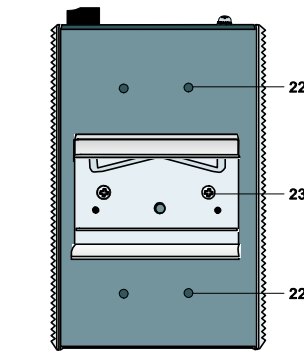
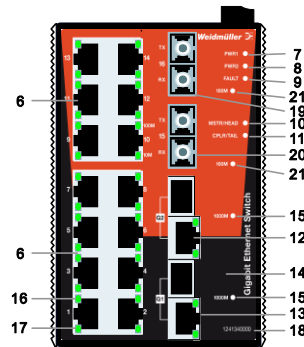

Mounting Dimensions (unit = mm)

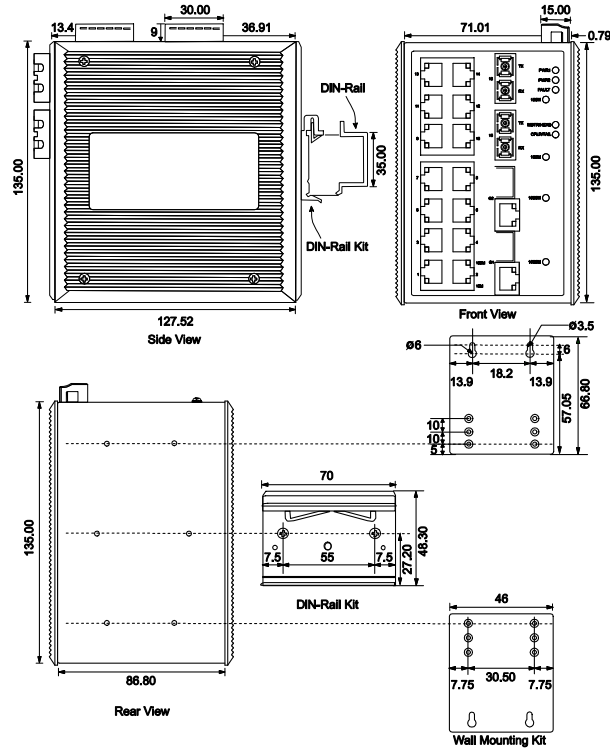

DIN-Rail Mounting

The aluminum DIN-Rail attachment plate should already be fixed to the back panel of IE-SW-PL18M when you take it out of the box. If you need to reattach the DIN-Rail attachment plate to IE-SW-PL18M, make sure the stiff metal spring is situated towards the top, as shown by the following figures.

STEP 1—Insert the top of the DIN-Rail into the slot just below the stiff metal spring.

STEP 2—The DIN-Rail attachment unit will snap into place as shown in the following illustration.

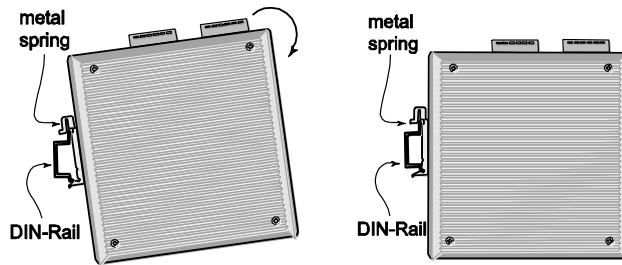

To remove the IE-SW-PL18M from the DIN-Rail, simply reverse Steps 1 and 2 above.



II 3G ATEX Information

1. Certification number DEMKO 11 ATEX 150191X
2. Ambient range ($-40^{\circ}\text{C} \leq T_{\text{amb}} \leq 75^{\circ}\text{C}$)
3. Certification string (Ex nC IIC T4)
4. Standards covered (EN60079-0:2006, EN60079-15:2005)
5. The conditions of safe usage:



- The Ethernet Communication Devices are to be mounted in an IP54 enclosure and used in an area of not more than pollution degree 2 as defined by IEC60664-1.
- A 4mm² conductor must be used when connection to the external grounding screw is utilized.
- Conductors suitable for use in an ambient temperature of 93°C must be used for the Power Supply Terminal.
- Provisions shall be made, either in external to the apparatus, to prevent the rated voltage being exceeded by the transients disturbances of more than 40%.

Wiring Requirements



WARNING

Do not disconnect modules or wires unless power has been switched off or the area is known to be non-hazardous. The devices may only be connected to the supply voltage shown on the type plate. The devices are designed for operation with a Safety Extra-Low Voltage. Thus, they may only be connected to the supply voltage connections and to the signal contact with the Safety Extra-Low Voltages (SELV) in compliance with IEC950/EN60950/ VDE0805.



ATTENTION

This unit is a built-in type. When the unit is installed in another piece of equipment, the equipment enclosing the unit must comply with fire enclosure regulation IEC 60950/EN60950 (or similar regulation).



ATTENTION

Safety First!

Be sure to disconnect the power cord before installing and/or wiring your Ethernet Switch.

Calculate the maximum possible current in each power wire and common wire. Observe all electrical codes dictating the maximum current allowable for each wire size.

If the current goes above the maximum ratings, the wiring could overheat, causing serious damage to your equipment.

You should also pay attention to the following points:

- Use separate paths to route wiring for power and devices. If power wiring and device wiring paths must cross, make sure the wires are perpendicular at the intersection point
- NOTE: Do not run signal or communications wiring and power wiring through the same wire conduit. To avoid interference, wires with different signal characteristics should be routed separately
- You can use the type of signal transmitted through a wire to determine which wires should be kept separate. The rule of thumb is that wiring that shares similar electrical characteristics can be bundled together
- Separate input wiring and output wiring
- We advise that you label wiring to all devices in the system when necessary.

Grounding the IE-SW-PL18M

Grounding and wire routing help limit the effects of noise due to electromagnetic interference (EMI). Run the ground connection from the ground screw to the grounding surface prior to connecting devices.



ATTENTION

This product is intended to be mounted to a well-grounded mounting surface such as a metal panel.

Wiring the Relay Contact

IE-SW-PL18M-Switches have two sets of relay outputs - relay 1 and relay 2. Each relay contact consists of the two contacts of the terminal block on the top panel of IE-SW-PL18M-Switch. You can refer to the next section for detailed instructions on how to connect the wires to the terminal block connector, and how to attach the terminal block connector to the terminal block receptor.

In this section, we will explain the meaning of the two contacts used to connect the Relay Contact.

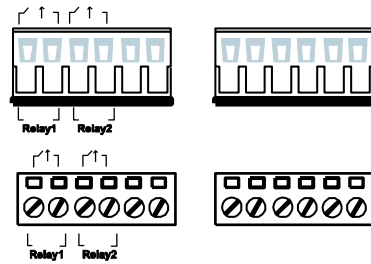

FAULT:

The two sets of relay contacts of the 6-pin terminal block connector are used to detect user-configured events. The two wires attached to the fault contacts form an open circuit when a user-configured event is triggered. If a user-configured event does not occur, the fault circuit remains closed.

Wiring the Redundant Power Inputs

IE-SW-PL18M-Switches have two sets of power inputs - power input 1 and power input 2 – located on the 6-pin terminal block connector on the top panel of the device. See sketch below how to connect.

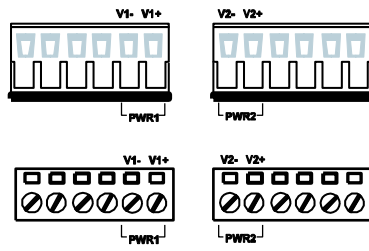

STEP 1: Insert the negative/positive DC wires into the V-/V+ terminals, respectively.

STEP 2: To keep the DC wires from pulling loose, use a small flat-blade screwdriver to tighten the wire-clamp screws on the front of the terminal block connector.

STEP 3: Insert the plastic terminal block connector prongs into the terminal block receptor, which is located on the switch's top panel.

Wiring the Digital Inputs

IE-SW-PL18M-Switches have two sets of digital inputs, DI 1 and DI 2. Each DI consists of two contacts of the 6-pin terminal block connector on Switch's top panel, which are used for Switch's two DC inputs. The top and front views of one of the terminal block connectors are shown here.

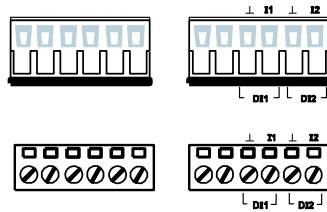

STEP 1: Insert the negative (ground)/positive DI wires into the \perp /I1 terminals, respectively.

STEP 2: To keep the DI wires from pulling loose, use a small flat-blade screwdriver to tighten the wire-clamp screws on the front of the terminal block connector.

STEP 3: Insert the plastic terminal block connector prongs into the terminal block receptor, which is located on the IE-SW-PL18M's top panel.

Communication Connections

All models of IE-SW-PL18M-Switches have one RJ45 console port (RS-232 interface), between 14 and 16 10/100BaseTX Ethernet ports. Some models also have 2 100BaseFX (SC/ST-type connector) fiber ports.

In this section, we present two types of diagrams - Pinout Diagrams and Cable Wiring Diagrams - to convey information about the ports and the cables used to connect IE-SW-PL18M Series to other devices:

Pinouts—The meaning of the “Pinouts” diagrams is straightforward. The diagrams simply display the type of signal passing through each of the port's pins.

Cable Wiring—Diagrams labeled “**Cable Wiring**” present standard cable wiring schemes for cables used to connect Ethernet Switch ports to other devices. These diagrams display three pieces of information:

1. When building your own cable, refer to the “**pin-to-pin**” Cable Wiring information displayed between the two vertical dashed lines to see which pin of the connector on the left should be connected to which pin of the connector on the right.
2. The information to the left of the left vertical dashed lines gives the pinouts of the relevant Ethernet Switch port.
3. The information to the right of the right vertical dashed line gives the pinouts of the opposing device’s port.

NOTE

1. The pin numbers for male DB9 and DB25 connectors, and hole numbers for female DB9 and DB25 connectors are labeled on the connector. However, the numbers are typically quite small, so you may need to use a magnifying glass to see the numbers clearly.
2. The pin numbers for both 8-pin and 10-pin RJ45 connectors (and ports) are typically not labeled on the connector (or port). Refer to the following Pinout and Cable Wiring diagrams to see how RJ45 pins are numbered

RS-232 Connection

IE-SW-PL18M Series has one RS-232 (10-pin RJ45) console port, located on the top panel. Use either an RJ45-to-DB9 or RJ45-to-DB25 cable (see the cable following wiring diagrams) to connect the console port of a IE-SW-PL18M switch to your PC’s COM port. You may then use a console terminal program, such as Windows Hyper Terminal, to access the switch console configuration utility.

RJ45 (10-pin) Console Port Pinouts

Pin	Description
1	-----
2	DSR
3	-----
4	GND
5	TxD
6	RxD
7	GND
8	-----
9	DTR
10	-----

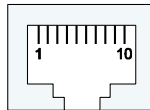

RJ45 (10-pin) to DB9 (F) Cable Wiring

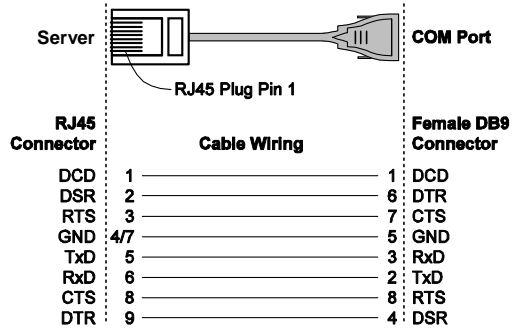

RJ45 (10-pin) to DB25 (F) Cable Wiring

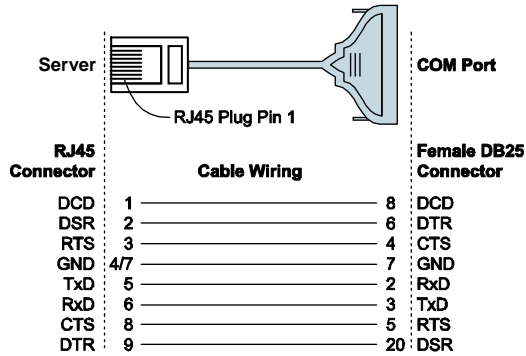

10/100BaseT(X) Ethernet Port Connection

The 10/100BaseT(X) ports located on the Switch's front panel are used to connect to Ethernet-enabled devices. Most users will choose to configure these ports for Auto MDI/MDI-X mode, in which case the port's pinouts are adjusted automatically depending on the type of Ethernet cable used (straight-through or cross-over), and the type of device (NIC-type or HUB/Switch-type) connected to the port.

In what follows, we give pinouts for both MDI (NIC-type) ports and MDI-X (HUB/Switch-type) ports. We also give cable wiring diagrams for straight-through and cross-over Ethernet cables.

RJ45 (8-pin, MDI) Port Pinouts

Pin	Signal
1	Tx+
2	Tx-
3	Rx+
6	Rx-

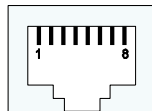

RJ45 (8-pin, MDI-X) Port Pinouts

Pin	Signal
1	Rx+
2	Rx-
3	Tx+
6	Tx-

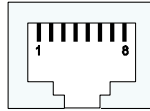

RJ45 (8-pin) to RJ45 (8-pin) Straight-through Cable Wiring

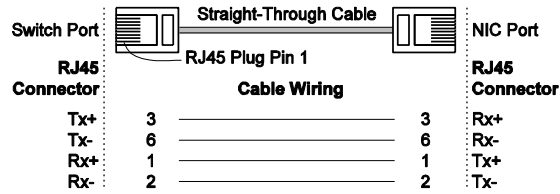

RJ45 (8-pin) to RJ45 (8-pin) Cross-over Cable Wiring

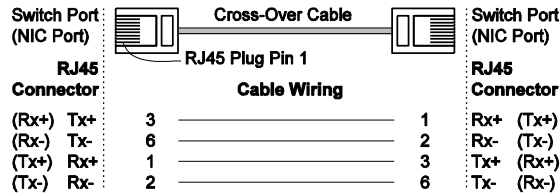

100BaseFx Ethernet Port Connection

The concept behind the SC/ST port and cable is quite straightforward. Suppose you are connecting devices I and II. As opposed to electrical signals, optical signals do not require a circuit in order to transmit data. Consequently, one of the optical lines is used to transmit data from device I to device II, and the other optical line is used transmit data from device II to device I, for full-duplex transmission.

All you need to remember is to connect the **Tx (transmit)** port of device I to the **Rx (receive)** port of device II, and the **Rx (receive)** port of device I to the **Tx (transmit)** port of device II.

SC-Port Pinouts ST-Port Pinouts

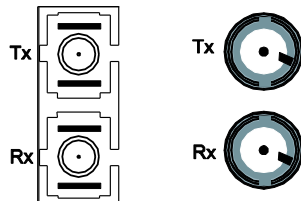

**ATTENTION**

This is a Class 1 Laser/LED product. To prevent damage to your eyes, do not stare directly into the laser beam.

LED Indicators

The front panel of IE-SW-PL18M Series contains several LED indicators. The function of each LED is described in the following table:

LED	Color	State	Description
PWR1	AMBER	On	Power is being supplied to power input P1.
		Off	Power is not being supplied to power input P1.
PWR2	AMBER	On	Power is being supplied to power input P2.
		Off	Power is not being supplied to power input P2.
FAULT	RED	On	When the corresponding PORT alarm is enabled, and a user-configured event is triggered.
		Off	When the corresponding PORT alarm is enabled and a user-configured event is not triggered, or when the corresponding PORT alarm is disabled.
MSTR/HEAD	GREEN	On	When the switch is set as the Master of the Turbo Ring, or as the Head of the Turbo Chain.
		Blinking	The switch has become the Ring Master of the Turbo Ring, or the Head of the Turbo Chain, after the Turbo Ring or the Turbo Chain is down.
		Off	When the switch is not the Master of this Turbo Ring or is set as the Member of the Turbo Chain.
CPLR/TAIL	GREEN	On	When the switch coupling function is enabled to form a back-up path, or when it's set as the Tail of the Turbo Chain.
		Blinking	When the Turbo Chain is down.
		Off	When the switch disables the coupling function.
10M (TP)	GREEN	On	TP port's 10 Mbps link is active.
		Blinking	Data is being transmitted at 10 Mbps.
		Off	TP port's 10 Mbps link is inactive.
100M	GREEN	On	TP port's 100 Mbps link is active.

(TP)		Blinking	Data is being transmitted at 100 Mbps.
		Off	TP port's 100 Mbps link is inactive.
1000M (TP/SFP)	GREEN	On	TP/SFP port's 1000 Mbps link is active.
		Blinking	Data is being transmitted at 1000 Mbps.
		Off	TP/SFP port's 1000 Mbps link is inactive.

Specifications

Technology

Standards IEEE 802.3 for 10BaseT,
IEEE 802.3u for 100BaseT(X) and 100Base FX,
IEEE 802.3ab for 1000BaseT(X),
IEEE 802.3z for 1000BaseSX/LX/LHX/ZX,
IEEE 802.3x for Flow Control,
IEEE 802.1D for Spanning Tree Protocol,
IEEE 802.1w for Rapid STP,
IEEE 802.1Q for VLAN Tagging,
IEEE 802.1p for Class of Service,
IEEE 802.1X for Authentication,
IEEE 802.3ad for Port Trunk with LACP

Protocols IGMPv1/v2, GMRP, GVRP, SNMPv1/v2c/v3,
DHCP Server/Client, DHCP Option 66/67/82,
BootP, TFTP, SNTP, SMTP, RARP, RMON,
HTTP, HTTPS, Telnet, SSH, Syslog, IPv6, LLDP,
IEEE 1588 PTP, Modbus/TCP, SNMP Inform

MIB MIB-II, Ethernet-like MIB, P-BRIDGE MIB,
Q-BRIDGE MIB, Bridge MIB, RSTP MIB, RMON
MIB Group 1,2,3,9

Interface

RJ45 Ports 10/100/1000BaseT(X) auto negotiation speed, F/H
duplex mode, and auto MDI/MDI-X connection

Fiber Ports Optional 100BaseFX (SC/ST connector) and
1000BaseSFP slot

Console Port RS-232 (10-pin RJ45)

LED Indicators PWR1, PWR2, FAULT, 10/100M (TP port), 100M
(fiber port), 1000M, MSTR/HEAD and CPLR/TAIL

Alarm Contact Two relay outputs with current carrying capacity of
1A @ 24 VDC

Digital Input Two inputs with the same ground, but electrically
isolated from the electronics

- For state "1": +13 to +30V
- For state "0": -30 to +3V
- Max. input current: 8 mA

Optical Fiber-100BaseFX**Optical Fiber-1000BaseSX/LX/LHX**

	SX	LX	LHX
Wavelength	850 nm	1310 nm	1310 nm
Max. Tx	-4 dBm	-3 dBm	1 dBm
Min. Tx	-9.5 dBm	-9.5 dBm	-4 dBm
Rx Sensitivity	-18 dBm	-20 dBm	-24 dBm
Link Budget	8.5 dB	10.5 dB	20 dB
Typical Distance	550m (a) 275m (b)	1100m (c) 550m (d) 10km (e)	40km (e)
Saturation	0 dBm	-3 dBm	-3 dBm
a. [50/125 μ m, 400 MHz*km] cable b. [62.5/125 μ m, 200 MHz*km] cable c. [50/125 μ m, 800 MHz*km] cable d. [62.5/125 μ m, 500 MHz*km] cable e. [9/125 μ m, 3.5 PS/(nm*km)] cable			

	10A	10B	20A	20B
Wavelength	TX:1310nm RX:1550nm	TX:1550nm RX:1310nm	TX:1310nm RX:1550nm	TX:1550nm RX:1310nm
Max. Tx	-3 dBm	-3 dBm	-2 dBm	-2 dBm
Min. Tx	-9 dBm	-9 dBm	-8 dBm	-8 dBm
Rx Sensitivity	-21 dBm	-21 dBm	-23 dBm	-23 dBm
Link Budget	12 dB	12 dB	15 dB	15 dB
Typical Distance	10 km	10 km	20 km	20 km
Saturation	-1 dBm	-1 dBm	-1 dBm	-1 dBm
a. [50/125 μ m, 400 MHz*km] cable b. [62.5/125 μ m, 200 MHz*km] cable c. [50/125 μ m, 800 MHz*km] cable d. [62.5/125 μ m, 500 MHz*km] cable e. [9/125 μ m, 3.5 PS/(nm*km)] cable				

Power

Input Voltage	24 VDC (12 to 45 VDC), redundant inputs
Input Current (@24V)	0.51A: IE-SW-PL18M-2GC-16TX 0.61A: IE-SW-PL18M-2GC14TX2SC/2ST/2SCS
Connection	Two removable 6-pin terminal blocks
Overload Current Protect.	Present
Reverse Polarity Protection	Present

Mechanical

Casing	IP30 protection, metal case
Dimensions	95 × 135 × 140 mm (W × H × D)
Weight	1.63 kg
Installation	DIN-Rail, Wall Mounting

Environment

Operating Temperature	0 to 60°C (32 to 140°F) -40 to 75°C (-40 to 167°F) for -T models
-----------------------	---

Storage Temperature -40 to 85°C (-40 to 185°F)
Ambient Relative Humidity 5% to 95% (non-condensing)

Regulatory Approvals

Safety	UL60950-1, UL 508 CSA C22.2 No. 60950-1, EN60950-1
Hazardous Location	UL/cUL Class I, Division 2, Groups A, B, C, and D, ATEX, Zone 2, Ex nC IIC
EMI	FCC Part 15, CISPR (EN55022) class A
EMS	EN61000-4-2 (ESD), Level 2 EN61000-4-3 (RS), Level 3 EN61000-4-4 (EFT), Level 2 EN61000-4-5 (Surge), Level 3 EN61000-4-6 (CS), Level 3 EN61000-4-8 EN61000-4-11 EN61000-4-12
Shock	IEC60068-2-27
Freefall	IEC60068-2-32
Vibration	IEC60068-2-6
WARRANTY	5 years

Weidmüller gives a 5 year warranty on this product in accordance with the warranty terms as described in the general conditions of sale of the Weidmüller company which has sold the products to you. Weidmüller warrants to you that such products the defects of which have already existed at the time when the risk passed will be repaired by Weidmüller free of charge or that Weidmüller will provide a new, functionally equivalent product to replace the defective one. Safe where expressly described otherwise in writing in this catalogue/product description, Weidmüller gives no warranty or guarantee as to the interoperability in specific systems or as to the fitness for any particular purpose. To the extent permitted by law, any claims for damages and reimbursement of expenses, based on whatever legal reason, including contract or tort, shall be excluded. Where not expressly stated otherwise in this warranty, the general conditions of purchase and the expressive liability commitments therein of the respective Weidmüller company which has sold the products to you shall be applicable.

Contact Information

Weidmüller Interface GmbH & Co. KG
Postfach 3030
32760 Detmold
Klingenbergstraße 16
32758 Detmold
Germany

Phone +49 (0) 5231 14-0
Fax +49 (0) 5231 14-2083
E-Mail info@weidmueller.com
Internet www.weidmueller.com