

Manual

LKS-1

Artikel-Nr. 72-00045 | 72-00046

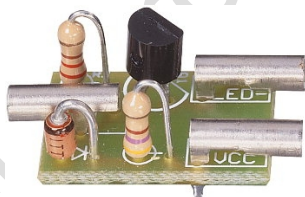

LED constant current source

Table of contents

1. Getting started.....	3
2. Safety instructions.....	4
3. Safe and correct soldering.....	7
4. Operation overview.....	8
5. Technical specifications.....	9
6. Assembling the kit.....	10
7. Connecting the LKS-1.....	13
8. Check list for troubleshooting.....	16
9. Guarantee bond.....	18
10. EU declaration of conformity.....	19
11. Declarations conforming to the WEEE directive.....	19

© 09/2016 Tams Elektronik GmbH

All rights reserved. No part of this publication may be reproduced or transmitted in any form or by any means, electronic or mechanical, including photocopying, without prior permission in writing from Tams Elektronik GmbH.

Subject to technical modification.

1. Getting started

How to use this manual

This manual gives step-by-step instructions for safe and correct assembly of the kit and fitting and connecting of the ready-built module, and operation. Before you start, we advise you to read the whole manual, particularly the chapter on safety instructions and the checklist for trouble shooting. You will then know where to take care and how to prevent mistakes which take a lot of effort to correct.

Keep this manual safely so that you can solve problems in the future. If you pass the kit or the ready-built module on to another person, please pass on the manual with it.

Intended use

The LED constant current source LKS-1 is designed to be operated according to the instructions in this manual in model building, especially with model railways. Any other use is inappropriate and invalidates any guarantees.

The LKS-1 should not be assembled or mounted by children under the age of 14.

Reading, understanding and following the instructions in this manual are mandatory for the user.

Checking the package contents

Please make sure that your package contains:

- one kit LKS-1, containing the components listed in the parts list and one PCB or
- one ready-built module LKS-1 and one diode 1N400x (x=2...7)
- a CD (containing the manual and further information).

Required materials

For assembling the kit you need:

- an electronic soldering iron (max. 30 Watt) or a regulated soldering iron with a fine tip and a soldering iron stand,
- a tip-cleaning sponge,
- a heat-resistant mat,
- a small side cutter and wire stripper,
- as necessary a pair of tweezers and long nose pliers,
- electronic tin solder (0,5 mm. diameter).

In order to connect the module you need wire. Recommended diameters: $\geq 0,05 \text{ mm}^2$ for all connections.

2. Safety instructions

Mechanical hazards

Cut wires can have sharp ends and can cause serious injuries. Watch out for sharp edges when you pick up the PCB.

Visibly damaged parts can cause unpredictable danger. Do not use damaged parts: recycle and replace them with new ones.

Electrical hazards

- Touching powered, live components,
 - touching conducting components which are live due to malfunction,
 - short circuits and connecting the circuit to another voltage than specified,
 - impermissibly high humidity and condensation build up
- can cause serious injury due to electrical shock. Take the following precautions to prevent this danger:

- Never perform wiring on a powered module.
- Assembling and mounting the kit should only be done in closed, clean, dry rooms. Beware of humidity.
- Only use low power for this module as described in this manual and only use certified transformers.
- Connect transformers and soldering irons only in approved mains sockets installed by an authorised electrician.
- Observe cable diameter requirements.
- After condensation build up, allow a minimum of 2 hours for dispersion.
- Use only original spare parts if you have to repair the kit or the ready-built module.

Fire risk

Touching flammable material with a hot soldering iron can cause fire, which can result in injury or death through burns or suffocation. Connect your soldering iron or soldering station only when actually needed. Always keep the soldering iron away from inflammable materials. Use a suitable soldering iron stand. Never leave a hot soldering iron or station unattended.

Thermal danger

A hot soldering iron or liquid solder accidentally touching your skin can cause skin burns. As a precaution:

- use a heat-resistant mat during soldering,
- always put the hot soldering iron in the soldering iron stand,
- point the soldering iron tip carefully when soldering, and
- remove liquid solder with a thick wet rag or wet sponge from the soldering tip.

Dangerous environments

A working area that is too small or cramped is unsuitable and can cause accidents, fires and injury. Prevent this by working in a clean, dry room with enough freedom of movement.

Other dangers

Children can cause any of the accidents mentioned above because they are inattentive and not responsible enough. Children under the age of 14 should not be allowed to work with this kit or the ready-built module.

**Caution:**

Little children can swallow small components with sharp edges, with fatal results! Do not allow components to reach small children.

In schools, training centres, clubs and workshops, assembly must be supervised by qualified personnel.

In industrial institutions, health and safety regulations applying to electronic work must be adhered to.

3. Safe and correct soldering

**Caution:**

Incorrect soldering can cause dangers through fires and heat. Avoid these dangers by reading and following the directions given in the chapter **Safety instructions**.

- Use a small soldering iron with max. 30 Watt or a regulated soldering iron.
- Only use electronic tin solder with flux.
- When soldering electronic circuits never use soldering-water or soldering grease. They contain acids that can corrode components and copper tracks.
- Insert the component connecting pins of into the PCB's holes as far as possible without force. The components should be close to the PCB's surface.
- Observe correct polarity orientation of the parts before soldering.
- Solder quickly: holding the iron on the joints longer than necessary can destroy components and can damage copper tracks or soldering eyes.
- Apply the soldering tip to the soldering spot in such a way that the part and the soldering eye are heated at the same time. Simultaneously add solder (not too much). As soon as the solder becomes liquid take it away. Hold the soldering tip at the spot for a few seconds so that the solder flows into the joint, then remove the soldering iron.
- Do not move the component for about 5 seconds after soldering.
- To make a good soldering joint you must use a clean and unoxidised soldering tip. Clean the soldering tip with a damp piece of cloth, a damp sponge or a piece of silicon cloth.

- Cut the wires after soldering directly above the soldering joint with a side cutter.
- After placing the parts, please double check for correct polarity. Check the PCB tracks for solder bridges and short circuits created by accident. This would cause faulty operation or, in the worst case, damage. You can remove excess solder by putting a clean soldering tip on the spot. The solder will become liquid again and flow from the soldering spot to the soldering tip.

4. Operation overview

LEDs are most suitable as a lighting for locomotives and carriages. But there are some snags with this apparently simple solution:

- On analogue layouts the LEDs light the brighter the higher the voltage is (i.e. the faster the locomotive is driving).
- With digital layouts this problem does not occur as there is a constant voltage at the rails. But LEDs with series resistors figured up for 18 V d.c. voltage light in layouts supplied with 12 V too dark and with 24 V too bright.

By use of the LED constant current source LKS-1 you can solve these problems. A transistor ensures, that during operation a constant current of approximately 25 mA is available.

This allows LEDs to be connected directly without series resistors. They have a constant brightness after reaching the required minimum voltage, independent from the voltage supplied. The minimum voltage for blue and white LEDs is approx. 4 V, for different-coloured LEDs approx. 3 V.

5. Technical specifications

Supply voltage	analogue a.c. or d.c. voltage or digital voltage
Minimum voltage	approx. 3 V (yellow and red LEDs) or 4 V (white and blue LEDs)
Maximum voltage	20 V a.c. voltage or 24 V d.c. voltage
Output current	approx. 25 mA
Protected to	IP 00
Ambient temperature in use Ambient temperature in storage	0 ... +60 °C -10 ... +80 °C
Comparative humidity allowed	max. 85 %
Dimensions of the PCB	approx. 18 x 12 mm
Weight of the assembled board	approx. 2,5 g

6. Assembling the kit

You can skip this part if you have purchased a ready-built module or device.

Preparation

Put the sorted components in front of you on your workbench.

The separate electronic components have the following special features you should take into account in assembling:

Resistors

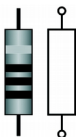

Resistors reduce current.

The value of resistors for smaller power ratings is indicated through colour rings. Every colour stands for another figure.

Carbon film resistors have 4 colour rings. The 4th ring (given in brackets here) indicates the tolerance of the resistor (gold = 5 %).

220 Ω red - red - brown (gold)

470 Ω yellow - violet - brown (gold)

Diodes and Zener diodes

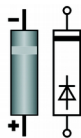

Diodes allow the current to pass through in one direction only (forward direction), simultaneously the voltage is reduced by 0,3 to 0,8 V. Exceeding of the limit voltage always will destroy the diode, and allow current to flow in the reverse direction.

Zener diodes are used for limiting voltages. In contrast to "normal" diodes they are not destroyed when the limit voltage is exceeded.

The diode type is printed on the package.

Transistors

Transistors are current amplifiers which convert low signals into stronger ones. There are several types in different package forms available. The type designation is printed on the component.

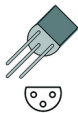

Transistors for a low power rating (e.g. BC types) have a package in form of a half cylinder (SOT-package). The three pins of bipolar transistors (e.g. BC types) are called basis, emitter and collector (abbreviated with the letters B, E, C in the circuit diagram).

PCB sockets

The widely spread 2,6 mm model railway connectors fit exactly to the sockets. These are used for the connection to the voltage supply and to connected modules or components.

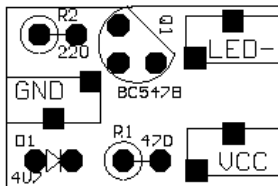

Fig. 1:
PCB layout

Parts list

Zener diode	D1	4,7 V
Diode	D2 (external connection)	1N400x, x=2...7
Transistor	Q1	BC547B
Resistors	R1	470 Ω
	R2	220 Ω
PCB sockets	GND, LED-, VCC	

Assembly

Proceed according to the order given in the list below. First solder the components on the solder side of the PCB and then cut the excess wires with the side cutter. Follow the instructions on soldering in section 3.



Caution:

Several components have to be mounted according to their polarity. When soldering these components the wrong way round, they can be damaged when you connect the power. In the worst case the whole circuit can be damaged. At the best, a wrongly connected part will not function.

1.	PCB sockets	
2.	Resistors	Mounting orientation of no importance.
3.	Diodes, Zener diodes	Observe the polarity! The negative end of the diodes is marked with a ring. This is shown in the PCB layout.
4.	Transistors	Observe the polarity! The cross section of transistors for a low power rating in SOT-packages is shown in the PCB layout.

Performing a visual check

Perform a visual check after the assembly of the module and remove faults if necessary:

- Remove all loose parts, wire ends or drops of solder from the PCB. Remove all sharp wire ends.
- Check that solder contacts which are close to each other are not unintentionally connected to each other. Risk of short circuit!
- Check that all components are polarised correctly.

When you have remedied all faults, go on to the next part.

7. Connecting the LKS-1

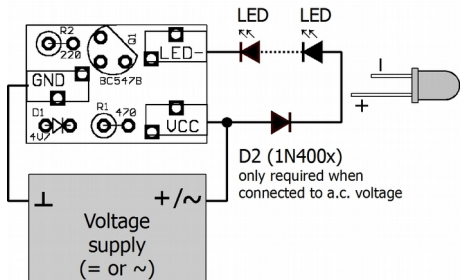

Fig. 2
Connections
diagram

GND	Voltage supply. With d.c. voltage: minus pole
VCC	Voltage supply. With d.c. voltage: plus pole Anode (+) of the LEDs
LED-	Cathode (-) of the LEDs

Connection to (analogue) a.c. voltage

When connecting the PCB to (analogue) a.c. voltage, the connections' polarity is not relevant. The LEDs light independently of the direction of travel. Connect the diode D2 (included in the package) in series to the LEDs. Otherwise the LEDs are possibly damaged after a short operating time.

Connection to (analogue) d.c. voltage

When connecting the PCB to (analogue) d.c. voltage, you have to observe the connections' polarity. Connect the connecting point "GND" to the minus pole and the connecting point "VCC" to the positive pole of the voltage supply.

The LEDs light in one direction of travel only when connected to (analogue) d.c. voltage. If they have to work in both directions of

travel, mount an additional bridge rectifier (e.g. item no. 83-19100-10, not included in delivery) according to the connection diagram.

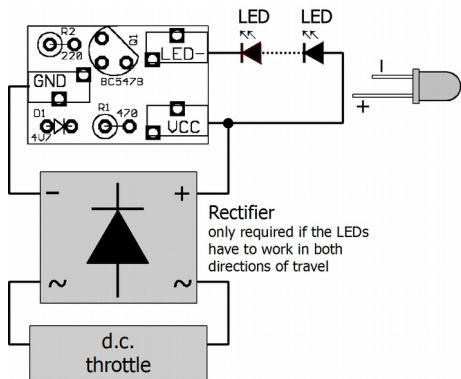

Fig. 3
Connecting
a rectifier

Connection to a decoder output

Connect the connection "GND" to the appropriate output of the locomotive or function decoder. Connect the connection "VCC" to the return conductor of the output or the return conductor for all outputs.

Alternatively you can connect the connection "VCC" to the vehicle's housing ground. Please note that in this case the LEDs flicker due to principle when the decoder is controlled in Motorola format.

Info: Light emitting diodes (LEDs)

When operated in the forward direction the LEDs light. They are available in several different versions (differing in colour, size, form, luminosity, maximum current, voltage limits). The longer lead of wired LEDs is normally the anode (positive pole). With SMD-LEDs the cathode normally is shown by a mark on the housing.

When using LEDs you always have to limit the current conduction (e.g. by mounting a series resistor), otherwise they will be damaged after a

short operating duration. The LKS-1 limits the current at the output to 25 mA. Thus it is possible to connect LEDs directly (without series resistor).

Connecting LEDs

You can connect one LED or several LEDs in series directly (without series resistor) to one LKS-1. The maximum number of LEDs you can connect to one PCB depends on the voltage supplied and the fluorescent colour of the LEDs.

Maximum number of LEDs per PCB connected in series

Forward voltage of the LEDs* ¹	Nominal / operating voltage of the transformer (=)* ²	Max. number of LEDs* ³	Nominal / operating voltage of the transformer (~)* ²	Max. number of LEDs* ³
2 V	12 V / 12 V	5	12 V / approx. 17 V	7
4 V	12 V / 12 V	2	12 V / approx. 17 V	3
2 V	16 V / 16 V	7	16 V / approx. 22 V	10
4 V	16 V / 16 V	3	16 V / approx. 22 V	5
2 V	18 V / 18 V	8	18 V / approx. 25 V	11
4 V	18 V / 18 V	4	18 V / approx. 25 V	5

*¹ The forward voltage of white and blue LEDs is approx. 4 V, differing coloured LEDs approx. 2 V.

*² Nominal voltage and operating voltage: The operating voltage with a.c. transformers is approx. 1,4 times the nominal voltage given on the transformer. With d.c. power packs the operating voltage corresponds to the given nominal voltage.

*³ Tolerance and / or voltage fluctuations in practice often cause the calculated operating voltage not being available. For that reason it is recommended to connect one LED less than possible in theory.

8. Check list for troubleshooting

- Parts are getting too hot and/or start to smoke.



Disconnect the system from the mains immediately!

Possible cause: one or more components are soldered incorrectly.
→ In case you have mounted the module from a kit, perform a visual check (→ section 6.) and if necessary, remedy the faults.
Otherwise send in the module for repair.

- The LED(s) does / do not light.

Possible cause: The diode D2 has been mounted with the wrong polarity. → Check the polarity.

Possible cause: The LED has been mounted with the wrong polarity.
→ Check the polarity.

Possible cause: The LED is defective. → Check the LED.

Possible cause: The connection to the power supply is interrupted.
→ Check the connections.

- The LED(s) only lights / light in one direction of motion.

Possible cause: There is no rectifier mounted in series although connected to direct voltage. → Mount a rectifier.

Hotline: If problems with your module occur, our hotline is pleased to help you (mail address on the last page).

Repairs: You can send in a defective module for repair (address on the last page). In case of guarantee the repair is free of charge for you. With damages not covered by guarantee, the maximum fee for the repair is the difference between the price for the ready-built module and the kit according to our valid price list. We reserve the right to reject the repairing of a module when the repair is impossible for technical or economic reasons.

Please do not send in modules for repair charged to us. In case of warranty we will reimburse the forwarding expenses up to the flat rate we charge according to our valid price list for the delivery of the product. With repairs not covered by guarantee you have to bear the expenses for sending back and forth.

9. Guarantee bond

For this product we issue voluntarily a guarantee of 2 years from the date of purchase by the first customer, but in maximum 3 years after the end of series production. The first customer is the consumer first purchasing the product from us, a dealer or another natural or juristic person reselling or mounting the product on the basis of self-employment. The guarantee exists supplementary to the legal warranty of merchantability due to the consumer by the seller.

The warranty includes the free correction of faults which can be proved to be due to material failure or factory flaw. With kits we guarantee the completeness and quality of the components as well as the function of the parts according to the parameters in not mounted state. We guarantee the adherence to the technical specifications when the kit has been assembled and the ready-built circuit connected according to the manual and when start and mode of operation follow the instructions.

We retain the right to repair, make improvements, to deliver spares or to return the purchase price. Other claims are excluded. Claims for secondary damages or product liability consist only according to legal requirements.

Condition for this guarantee to be valid, is the adherence to the manual. In addition, the guarantee claim is excluded in the following cases:

- if arbitrary changes in the circuit are made,
- if repair attempts have failed with a ready-built module or device,
- if damaged by other persons,
- if damaged by faulty operation or by careless use or abuse.

10. EU declaration of conformity

 This product conforms with the EC-directives mentioned below and is therefore CE certified.

2004/108/EG on electromagnetic. Underlying standards: EN 55014-1 and EN 61000-6-3. To guarantee the electromagnetic tolerance in operation you must take the following precautions:

- Connect the transformer only to an approved mains socket installed by an authorised electrician.
- Make no changes to the original parts and accurately follow the instructions, connection diagrams and PCB layout included with this manual.
- Use only original spare parts for repairs.

2011/65/EG on the restriction of the use of certain hazardous substances in electrical and electronic equipment (ROHS). Underlying standard: EN 50581.

11. Declarations conforming to the WEEE directive



This product conforms with the EC-directive 2012/19/EG on waste electrical and electronic equipment (WEEE).

Don't dispose of this product in the house refuse, bring it to the next recycling bay.

Information and tips:

<http://www.tams-online.de>

Warranty and service:

Tams Elektronik GmbH

Fuhrberger Straße 4

DE-30625 Hannover

fon: +49 (0)511 / 55 60 60

fax: +49 (0)511 / 55 61 61

e-mail: modellbahn@tams-online.de

