

**LC-R124R5P**

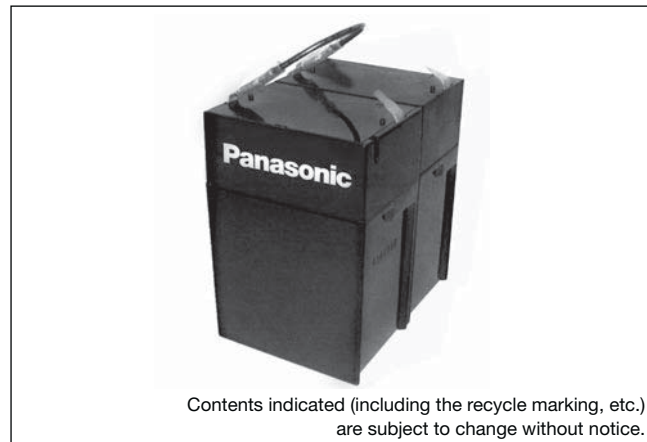

Contents indicated (including the recycle marking, etc.) are subject to change without notice.

For main and standby power supplies.  
Expected trickle design life: 6 – 9 years at 20°C according to Eurobat.

**Dimensions (mm)**

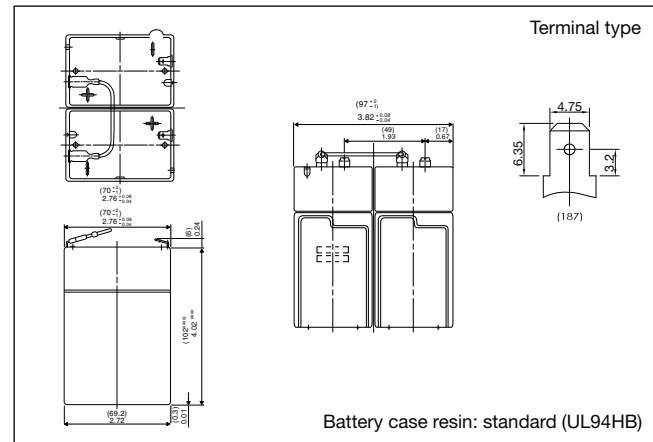

**Specifications**

Nominal voltage	12V	
Nominal capacity (20 hour rate)	4.5Ah	
Dimensions	Length	70mm
	Width	97mm
	Height	102mm
	Total Height	108mm
Approx. mass	1.45kg	
Terminal	Faston 187	

**Duration of discharge vs Discharge current**

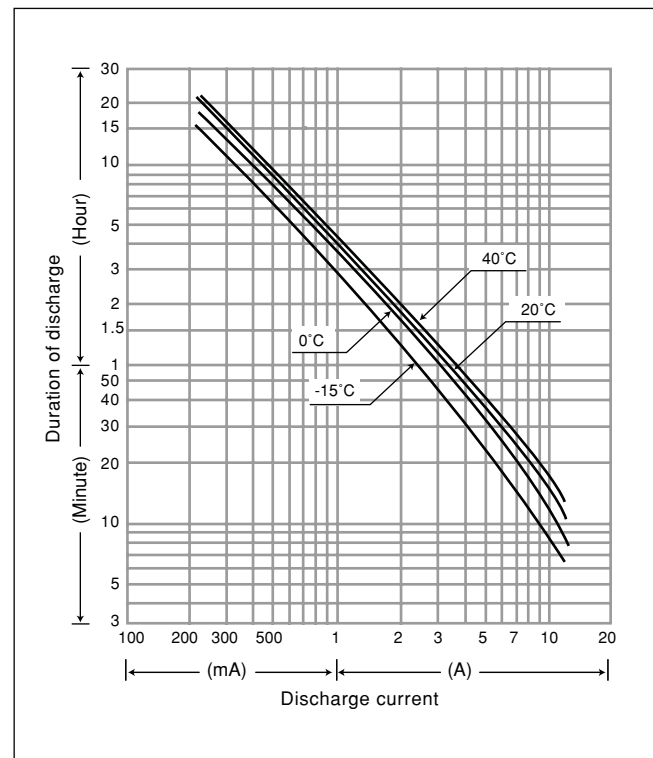

**Characteristics**

Capacity (25°C)	20 hour rate	4.5Ah
	10 hour rate	3.9Ah
	5 hour rate	3.5Ah
	1 hour rate	2.8Ah
Internal resistance	Fully charged battery (25°C)	40mΩ
Temperature dependency of capacity (20 hour rate)	40°C	102%
	25°C	100%
	0°C	85%
	-15°C	65%
Self discharge (25°C)	After 3 months	91%
	After 6 months	83%
	After 12 months	66%

**Watt Table**

Cut-off V	3min	5min	10min	15min	20min	30min	45min	1h	1.5h	2h	3h	4h	5h	6h	10h	20h	24h
9.6V	270	214	139.4	106.4	89.2	66.6	47	37.6	25.8	19.98	14.88	11.42	9.44	7.58	5.02	2.72	2.272
9.9V	250	200	136.6	105.6	87.8	65.8	46.6	37.6	25.4	19.84	14.8	11.36	9.36	7.56	5	2.72	2.266
10.2V	232	188	133	103.6	86.2	65	46.2	36.8	24.8	19.32	14.66	11.28	9.28	7.5	4.96	2.7	2.258
10.5V	206	168	123.2	96.4	82	63.6	45.4	36	24.2	18.64	14.42	11.2	9.2	7.4	4.92	2.7	2.25
10.8V	174	148	110	89.8	79.8	61.4	44.8	35.4	23.6	17.76	14.14	11.06	8.98	7.28	4.88	2.68	2.236

**Ampere Table**

Cut-off V	3min	5min	10min	15min	20min	30min	45min	1h	1.5h	2h	3h	4h	5h	6h	10h	20h	24h
9.6V	24.3	19.13	12.44	9.25	7.69	5.69	4.00	3.19	2.19	1.69	1.25	0.956	0.788	0.633	0.419	0.227	0.189
9.9V	22.6	17.94	12.19	9.19	7.56	5.63	3.98	3.19	2.14	1.68	1.24	0.950	0.781	0.630	0.417	0.226	0.189
10.2V	20.8	16.81	11.88	9.00	7.44	5.56	3.94	3.13	2.10	1.63	1.23	0.944	0.775	0.625	0.413	0.226	0.188
10.5V	18.5	15.06	11.00	8.38	7.06	5.44	3.88	3.06	2.06	1.58	1.21	0.938	0.769	0.618	0.411	0.225	0.188
10.8V	15.6	13.31	9.81	7.81	6.88	5.25	3.81	3.00	2.00	1.50	1.19	0.925	0.750	0.608	0.406	0.224	0.186

**Charging Method**

Trickle use	Control voltage: 13.6 - 13.8V; Initial current: 0.675A or smaller
-------------	---

**Cut off voltage**

Discharge current	0.225 A - 0.9A	0.9A - 2.25A	2.25A - 4.5A	4.5A - 9A	9A - 13.5A
Cut off voltage (V)	10.5	10.2	9.9	9.3	8.7

**Influence of Temperature on Trickle life**

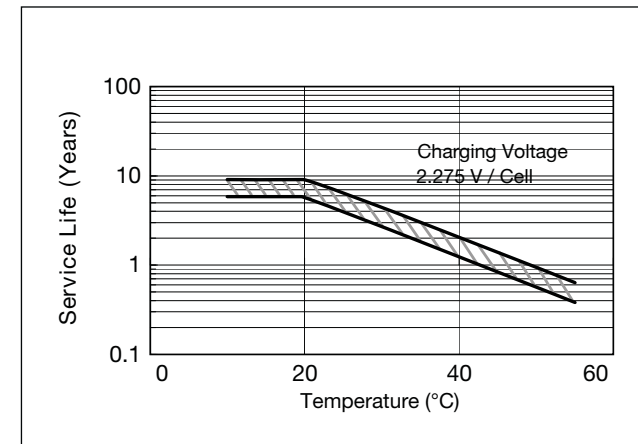

**Residual capacity vs storage period**

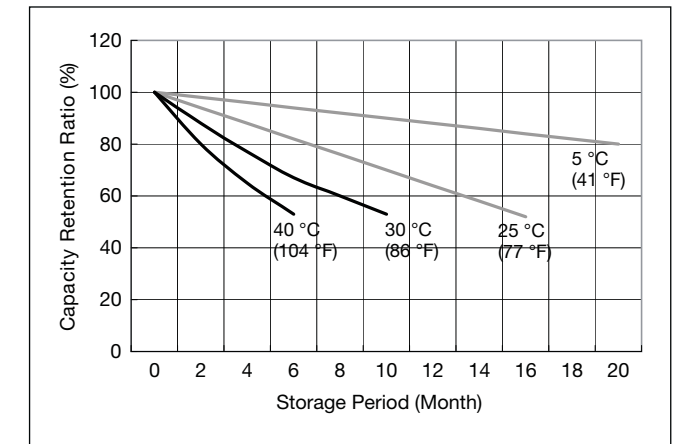

**Constant-voltage and constant-current charge characteristics for Trickle use**

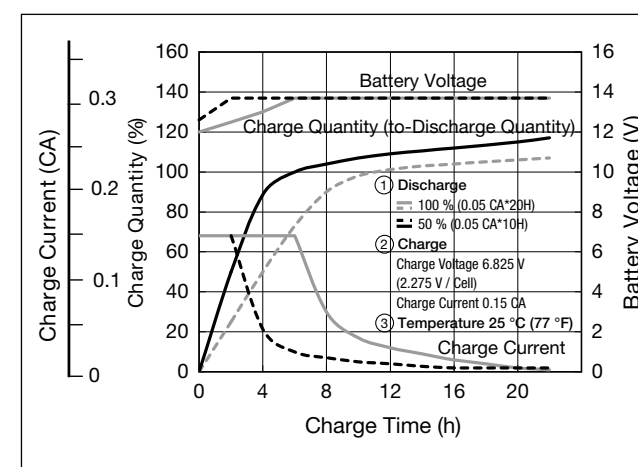

**Discharge capacity by temperature and by discharge current**

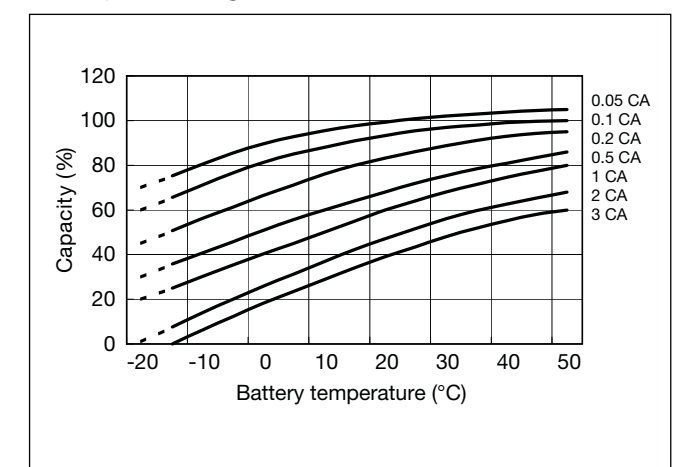

**Discharge characteristics**

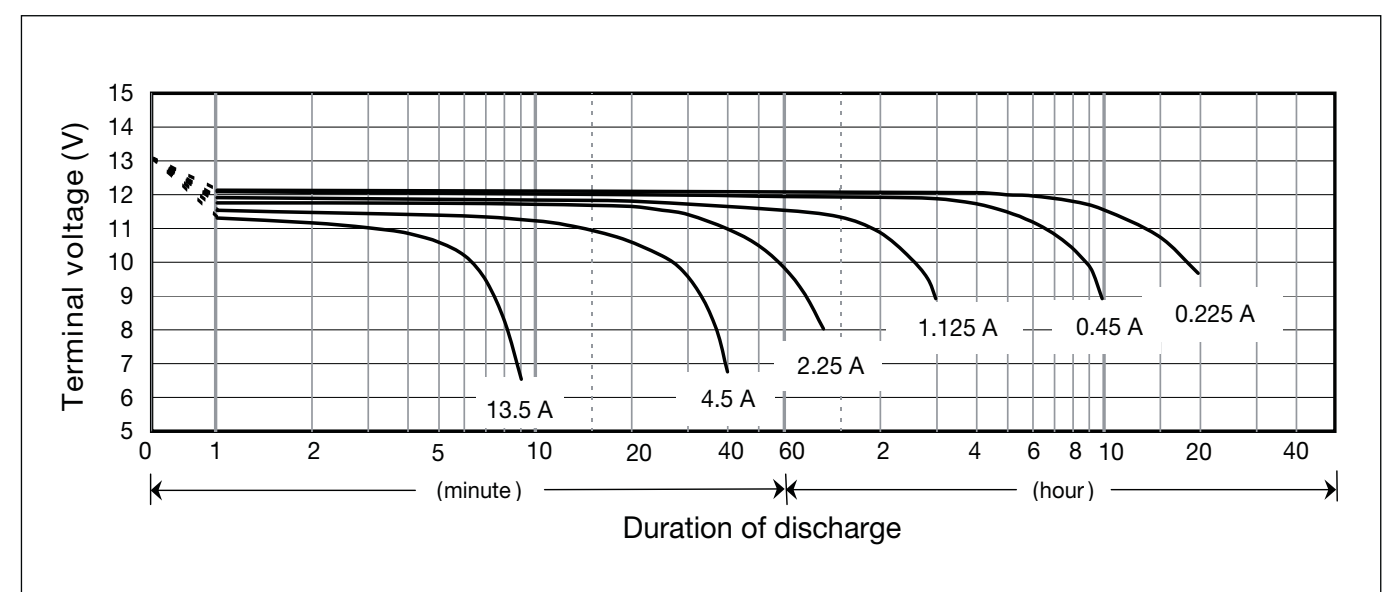

# VRLA HANDBOOK

ENGLISH

INDUSTRIAL BATTERIES





**PANASONIC BATTERIES**



**PANASONIC INDUSTRIAL EUROPE**

Panasonic Corporation, founded in Osaka 1918, is one of the world's largest manufacturers of quality electronic and electrical equipment. Its subsidiary, Panasonic Industrial Europe GmbH (PIE) deals with a wide diversified range of industrial products for all European countries. This company was formed in 1998 to strengthen Panasonic's Pan-European industry operation, and today is active in such different business fields as Automotive, Audio/Video & Communication, Appliance and Industry & Devices to satisfy its customer's needs.



Panasonic quality - certified by authorised companies.

We are able to offer you a wide range of individual power solutions for portable and stationary applications. Our product range includes high reliability batteries such as Lithium-Ion, Lithium, Nickel-Metal-Hydride, Valve-Regulated-Lead-Acid (VRLA), Alkaline and Zinc-Carbon. Based on this battery range we can power your business in virtually all applications.

Panasonic Energy Company (PEC) started its battery production in 1931. Today PEC is the most diversified global battery manufacturer with a network of 20 manufacturing companies in 14 countries. More than 16,000 employees are dedicated to the research & development and in the production of new batteries for a new world.

When it comes to production our facilities employ leading edge manufacturing processes meeting the highest quality standards. Our factories are certified to ISO standards. This means that each factory has its own quality and environmental management. The ISO 9000 and ISO 14000 series are the minimum benchmarks that ensure our excellent product reliability.

Furthermore the majority of our factories is also certified to OHSAS 18001 (Occupational Health and Safety Assessment Series), an international standard for assessing a management system for occupational safety. This confirms that our factories have been proactive in putting the occupational health and safety of its staff at the centre of the company's dealings. In addition our VRLA batteries are for example approved to German VdS standard and U.S. UL standard.

**PIE Organisation Divisions**

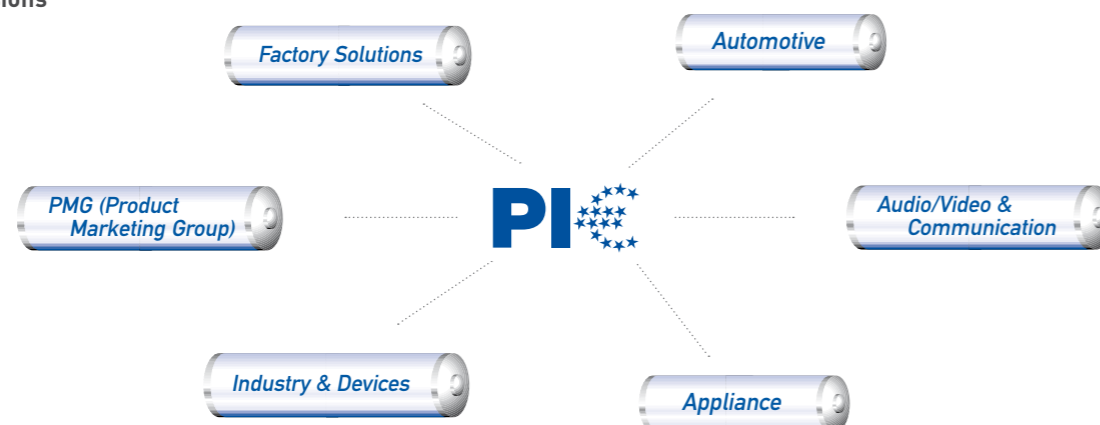





**PANASONIC LEADS THE WAY ... WITH 'ECO IDEAS'**

Pursuing coexistence with the global environment in its business vision, Panasonic places reduction of the environmental impact in all its business activities as one of the important themes in its mid-term management plan. In its 'eco ideas' Strategy, which focuses in particular on rapid implementation of measures to prevent global warming and global promotion of environmental sustainability management, Panasonic is advancing three key initiatives: 'eco ideas' for Manufacturing, 'eco ideas' for Products, and 'eco ideas' for Everybody, Everywhere.

**'ECO IDEAS' FOR MANUFACTURING**

**Our Plans**

We will reduce CO<sub>2</sub> emissions across all our manufacturing sites.

**Our Goals**

In each of our factories a CO<sub>2</sub> emissions of 10% reduction till 2010.

**Our Measures**

Our factories are evaluated with regard to CO<sub>2</sub> emission, waste disposal, recycling measures as well as chemical and water consumption within the scope of the 'Clean Factory' program and they are set performance targets according to these indicators.

**Example**

The Wakayama Plant of the Energy Company is strengthening its management structure to cut CO<sub>2</sub> emissions from the main production bases for Lithium-Ion batteries, which are a core component of Panasonic's energy business. As a result, it has succeeded in roughly halving CO<sub>2</sub> emissions per production unit, as well as sharply curbing an increase in CO<sub>2</sub> emissions even as production has expanded.

**'ECO IDEAS' FOR PRODUCTS**

**Our Plans**

We will produce energy-efficient products.

**Our Goals**

In March 2010 at least 20 products with the 'Superior Green Products' classification should be available.

**Our Measures**

The developers at Panasonic carry out an environmental impact assessment for all our products. Products that meet the highest environmental requirements in the branch with regard to conservation of energy and energy efficiency are classified as a 'Superior Green Product' and awarded the Panasonic logo 'eco ideas'.

**Example**

We have dispensed with the use of highly toxic Lithium Thionyl Chloride in the production of our Lithium batteries. This is quite rightly classified as highly toxic and should never under any circumstances be released into the environment.

**'ECO IDEAS' FOR EVERYBODY, EVERYWHERE**

**Our Plans**

We will encourage the spread of environmental activities throughout the world.

**Our Goals**

Intensive commitment on the part of the company owners, international cooperations and involvement of the employees.

**Our Measures**

Not only do we sponsor the work of the WWF for the Arctic, Panasonic has also launched a couple of other environmental initiatives such as the ECO RELAY initiative in which hundreds of colleagues the world over take part voluntarily for several days in environmental campaigns.

**Example**

With the support of the GRS Batterien (German Battery Recycling Association) Panasonic arranged a battery collection day with the aim of collecting as many of these spent energy sources as possible and giving out information about the recycling loop of batteries from which valuable raw materials such as Zinc, Manganese and Iron can be recovered.

Our **energy** will Drive **eco** Innovation.

**THE PANASONIC 'ECO IDEAS' HOUSE**

We are approaching a global turning corner and it would not be an exaggeration to call it the 'Environmental Industrial Revolution'. Based on this recognition, Panasonic has built an 'eco ideas' House on the premise of our showroom, Panasonic Center Tokyo in April 2009 in order to help create a carbon-free society and reduce CO<sub>2</sub> emissions from a household sector.

The concept of this 'eco ideas' House can be described as follows:

1. Virtually zero CO<sub>2</sub> emissions in an entire house envisaged in three to five years into the future
  2. Synergy of technology and nature
- Aforementioned concepts shows that Panasonic is not only aware of it's environmental responsibility moreover this Panasonic takes action.

## Index

<b>1   Precautions for Handling</b>	page	<b>7 – 12</b>
<b>2   General Information</b>	page	<b>13 – 15</b>
<b>3   Characteristics</b>	page	<b>16 – 18</b>
<b>4   Charging Methods</b>	page	<b>19 – 23</b>
<b>5   Terminal Data</b>	page	<b>23</b>
<b>6   Safety</b>	page	<b>24</b>
<b>7   Safety Design</b>	page	<b>24 – 25</b>
<b>8   Model Numbers</b>	page	<b>26 – 27</b>
<b>9   Battery Selection Chart</b>	page	<b>28 – 29</b>
<b>10   Battery Selection Guide</b>	page	<b>30</b>
<b>11   Battery Index</b>	page	<b>31 – 32</b>
<b>12   Standards</b>	page	<b>33 – 34</b>
<b>13   Individual Data Sheets</b>	page	<b>35 – 135</b>
<b>14   Glossary</b>	page	<b>136 – 137</b>

## 1 | Precautions for Handling VRLA-Batteries

This document should be read in its entirety and its contents fully understood before handling or using Panasonic rechargeable sealed Lead-Acid batteries. If there are any questions, please contact Panasonic. Please keep this document available for reference. Due to the potential energy stored in the batteries, improper handling or use of the batteries without understanding this document may result in injury caused by electrolyte leakage, heat generation, or explosion.

\* All descriptions are subject to change without notice.

### Degree of danger

#### 1. DANGER

When the batteries are handled or used improperly, death or severe injury may occur.

#### 2. WARNING

When the batteries are handled or used improperly, death or severe injury may occur, and sight injury or loss of products often occur.

#### 3. CAUTION

When the batteries are handled or used improperly, slight injury may occur and damage to the batteries and equipment may occur.

#### 4. REQUEST

When the batteries are handled or used improperly, damage to quality or performance may occur.

#### Note (1):

Improper handling and use of the batteries may cause dangerous conditions to arise. All precautions should be taken to prevent any harmful effects from the use of the batteries.

#### Note (2):

“Severe injury” as a result of improper handling or use of the batteries may include but are not limited to loss of eyesight, injury/burn/electric shock/fracture of a bone/poisoning with after effect, or injury that requires long-term medical treatment. “Slight injury” covers such conditions as burns or electric shock that do not require long-term medical treatment. Damage to products is defined as extensive damage to a house, a house hold effects, a livestock, or pets.

#### Note (3):

“Requests” are meant to prevent a decrease in the quality or the performance of the batteries.



## 1 | Precautions for Handling VRLA-Batteries

### 1. Environment and Condition

#### DANGER

(1) Do not put the batteries into airtight containers or bags. The batteries tend to generate inflammable gas upon excess charge which may cause an explosion if enclosed in an airtight container.

#### WARNING

(1) The batteries must be charged using the specified charger or by maintaining the charging conditions indicated by Panasonic. If the batteries are charged under conditions other than those specified by Panasonic, they may leak, generate excessive heat, or explode.

(2) When using the batteries in medical equipment, incorporate a back-up system other than the main battery in the event of power failure.

(3) Insert insulation that is resistant to heat and sulfuric acid between the batteries and any metallic housing. Failure to do so may cause the batteries to smoke or burn in case of electrolyte leakage.

(4) Do not place the batteries near a device that may generate sparks (such as a switch or fuse) and do not place the batteries close to fire. The batteries may generate an inflammable gas when charged excessively that may ignite upon contact with a spark or they may burn or explode due to sparks or fire.

#### CAUTION

(1) Use or store the batteries in the temperature range: Discharge (operating in application): -15°C ~ 50°C.

Charge: 0°C to 40°C. Storage: -15°C to 40°C.

Temperatures above or below those recommended could result in damage or deformity of the batteries.

(2) Avoid placing batteries near a heat-generating device (such as a transformer) which may cause the batteries to generate excessive heat, leak or explode.

(3) Do not allow the batteries to be exposed to rain or sea water. If the battery terminals should get wet, they may corrode.

(4) Do not use or store the batteries in a car under the blazing sun, in direct sunlight. To do so may cause the batteries to leak, generate excessive heat, or explode.

(5) Do not use or store the batteries in a dusty place as dust may cause them to short between their terminals. When using the batteries in a dusty place, check them periodically.

(6) In applications requiring more than one battery, first connect the batteries together and then connect the batteries to the charger or the load. Be careful to connect the (+)pole of the batteries to the (+)terminal of either the charger or the load. Improperly connecting the batteries, charger, or load may cause an explosion or fire to occur. In some cases, bodily injury may occur.

(7) When handling the batteries, wear steel-tipped shoes to prevent possible injury to the feet if the batteries are accidentally dropped.

#### REQUEST

(1) Dropping a battery may cause a strong physical shock that may damage the performance of the battery.

(2) Confirm the life of the batteries using the real load and charger. Differences in the charging and the discharging conditions may cause a big difference in the life of the batteries.

### 2. Installation

#### DANGER

(1) Tools such as wrenches used to install the batteries should be insulated. Bare metal tools may cause an abnormal short circuit accident to occur resulting in bodily injury, damage to the batteries, explosion or fire.

(2) Do not install the batteries in a room without ventilation. The batteries tend to generate an inflammable gas upon excess charge resulting in an explosion or fire if the room is closed.

#### WARNING

(1) **Do not contact any plastic or resin (\*) which contains a migrating plasticizer with the batteries. Furthermore, avoid using organic solvents such as thinner, gasoline, lamp oil, benzine and liquid detergent to clean the batteries.** The use of any of above materials may cause the containers and/or the covers (ABS resin) of the batteries to crack and leak. This may cause a fire in the worst scenario. Need to make sure the use of material will not cause the containers and/ or the covers (ABS resin) of the batteries to crack due to the migration of plasticizer within the material by asking the manufacturer of the material if necessary.

\* Examples for plastic or resin which should be avoided using:

Vinyl chloride, Oily rubber.

\* Examples for plastic or resin which is proper for the use:

Polyolefin resin such as polypropylene, polyethylene.

## 1 | Precautions for Handling VRLA-Batteries

(2) Always use such as rubber gloves when handling batteries with the voltages higher than 45 volts in order to prevent severe bodily injury from occurring.

(3) Do not install the batteries in areas where they may come in contact with water. If the batteries come in contact with water, an electric shock may occur.

#### CAUTION

(1) During unpacking, handle the batteries carefully and check for cracks, breakage, or electrolyte leakage. Failure to handle carefully may result in damage due to physical shock.

(2) When the batteries are being mounted in the equipment, consider the best position for easy checking, maintenance and replacement. In addition, the batteries should be located in the lowest part of the equipment as possible.

The Rechargeable Sealed Lead-Acid batteries, mentioned in this document, are designed for use in any position, but charging the batteries in the upside-down position should be avoided. When these batteries are charged excessively in the upside-down position, leakage of electrolyte from the rubber vents may occur. The upside-down is shown on the left side of the next drawings. In this upside-down position, the mark "Panasonic" on the battery are turned upside down. The drawings are only for explanation of the battery's position; therefore these are not equal to the real appearance of the battery that the specifications describe.

Can be used in the vertical position and the sidedown position (maximum angle of 90 degrees from the normal position).

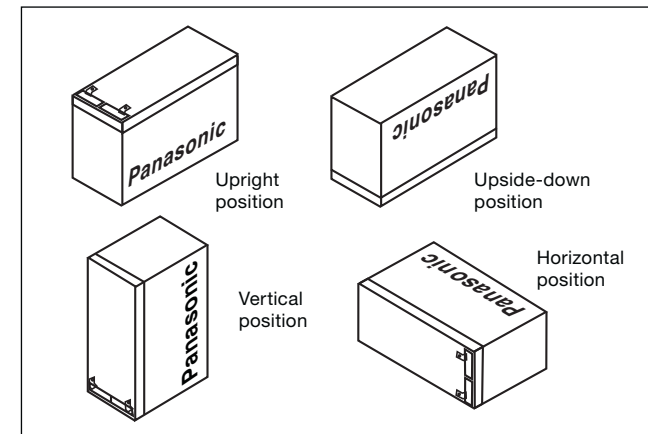

(3) Do not carry the batteries by picking up them by their terminals or lead wires. To do so may damage the batteries.

(4) Be careful not to jolt the batteries as it may result in damage to them.

(5) Be aware the batteries are relatively heavy compared to their volume. Please be careful to carry these batteries in order to avoid injury and/or lumbago.

(6) Do not cover the batteries with plastic sheet as it may cause a fire or an explosion by conducting static electricity.

(7) Fasten the bolts and the nuts with the torque as shown below: Not to do so may cause the battery terminals to break.

Bolt (nut) size (mm)			Fastening torque Nm
Diameter	Pitch	Length	
M5 (5)	0.8	15 ± 1	2.0 – 3.1
M6 (6)	1.0	20 ± 1	4.1 – 5.6
M8 (8)	1.25	20 ± 1	8.2 – 10.2
M10 (10)	1.5	25 ± 1	14.7 – 19.7

(8) Place the necessary insulating covers over the terminals, the connecting bars, and bolts and nuts to prevent a dangerous electric shock.

(9) Please consult Panasonic prior to using the batteries in applications such as a motor bicycle, an engine driven lawn mower, etc. which may generate severe vibration.

(10) Fasten the batteries firmly to the equipment to avoid the influence of vibration and/or physical shock.

#### REQUEST

(1) The batteries should be installed by a certified technician.

### 3. Preparation Prior to Operation

#### DANGER

(1) Be sure to provide enough insulation around the lead wires and/or plates used between the batteries and the application. Insufficient insulation may cause an electric shock heat generating from a short circuit (or excess current) may result in an injury, burn, smoke or fire.

#### CAUTION

(1) Do not plug the batteries directly into the outlet or the cigarette receptacle of a car without inserting a charger between the batteries and the outlet or the receptacle. To do so may cause electrolyte leakage, heat generation, or explosion of the battery.

(2) Turn off the circuit switch when the connections between the batteries and the charger/load are made.

## 1 | Precautions for Handling VRLA-Batteries

(3) When using the batteries for the first time, check for rust, heat generation, or any other abnormalities. If found, do not use as it may cause electrolyte leakage, heat generation, or explosion.

### REQUEST

(1) Since the batteries tend to lose a part of their capacity due to self-discharge during shipment and storage, recharge the batteries before you use them after purchase or long-term storage in order to restore their full capacity. Check for the following conditions before to recharge:

Charging method	Charging condition (at 20°C)
Constant voltage	<ul style="list-style-type: none"> <li>Regulation range of the controlled voltage: 7.25V to 7.45V / 6V battery, 14.5V to 14.9V / 12V battery; Initial current: 0.1CA to 0.4CA; Maximum charging time: 24 hours.</li> <li>Short-time charge is possible when several batteries of the same model, under the same storage conditions can be charged in series. Otherwise they can be charged separately.</li> </ul>
Constant current	<ul style="list-style-type: none"> <li>Charging current: 0.1CA</li> <li>Charging time (hours) = [Amount of self-discharge (Ah)/0.1CA] x 120%</li> <li>Rough estimation of amount of self-discharge is as follows (for an example): When the storage ambient temperature is lower than 20°C, and storage time is known, assume the following amount of self-discharge: [5%/month] x storage months</li> <li>Multiply this by the rated capacity (at 20 hour rate) of the battery.</li> <li>Regardless of the above calculation, the charge time for a refresh charge must be less than 12 hours.</li> <li>When the storage ambient temperature is higher than 20°C, please consult Panasonic.</li> </ul>

### 4. Unspecified Use

#### CAUTION

(1) Do not place the batteries in an unspecified use or they may leak, generate heat, or explode.

### 5. Method of Handling and Operation

#### DANGER

(1) Do not directly connect the positive and negative terminals with a conductive material such as a wire. Be careful

while using a metal tool such as a wrench and/or carrying the batteries with metallic necklaces and hairpins not to make a short circuit. A short of the battery's terminals may cause heat generation, an explosion or a fire.

#### WARNING

- (1) Never dispose of the batteries in a fire as it may cause them to explode or generate a toxic gas.
- (2) Do not attempt to disassemble the batteries as it could cause leakage of sulfuric acid that could cause injury.

#### CAUTION

- (1) To prevent accidents from happening, change any battery that is found to have an abnormality such as a crack, a deformity, or leakage. The batteries must be kept clean and free from dust to prevent loss of capacity or accident.
- (2) If any abnormality of the charge voltage or the discharge voltage is detected replace the batteries with new ones.
- (3) Charging the batteries with an inverse polarity connection between the batteries and the charger could cause electrolyte leakage, heat generation, or a fire.
- (4) Do not solder directly on the batteries' terminal tabs. Soldering directly on the batteries' terminals may cause a leak of electrolyte. Consult Panasonic when soldering is necessary.
- (5) Avoid the use of the batteries differing in capacity, type, history of use (charge/discharge operation). These differences could cause electrolyte leakage or heat generation.
- (6) Do not remove or scratch the outer tube of the battery or it may cause an electrolyte leakage or electrical leakage.
- (7) Do not allow the batteries to be subjected to any strong physical shocks or jolts while moving them. Treating the batteries roughly could cause leaks, heat generation, or explosions.
- (8) Do not charge the batteries beyond the amount of the time indicated in the specifications, or do not charge after the charge indication lamp indicates a full charge. Take the batteries off the charger if the charge is not finished after the specified charge time. Over-charging can cause leakage, heat generation, or explosions.
- (9) Children should be taught how to handle and use the batteries correctly.
- (10) Keep the batteries out of the reach of small children at all times.

## 1 | Precautions for Handling VRLA-Batteries

### REQUEST

(1) The cut-off voltage during discharge should vary depending on the discharge current. Do not discharge the batteries lower than the recommended cut-off voltage shown in Panasonic specifications or Panasonic technical handbooks. Recharging a battery which was once discharged below the recommended cut-off voltage may generate heat, resulting in the deformation of the battery or in condensation around the battery cover caused when moisture within the battery evaporates. In addition, the efficiency of the battery would eventually decrease.

Overdischarging a battery may result in reduced performance. Always recharge the batteries immediately after discharge even if the batteries were not discharged to the recommended cut-off voltage. If the batteries are not charged soon after discharge, the batteries performance may be reduced due to the so-called "sulfation phenomena".

Note: The cut-off device to prevent overdischarge should cut off all discharge current including any weak current.

(2) Thoroughly study the charge methods and the conditions of the batteries before adopting other charge methods which are not shown in the Panasonic specifications or the Panasonic technical handbook, for safety reasons.

(3) When the batteries are used in a cyclic application, it is important to charge the batteries for the proper amount of time. A timer should be incorporated into the charging circuit that will disconnect the charging current to prevent overcharging. Also, it is important to allow the battery to completely charge before removing the battery from the charger.

(4) Avoid parallel charging of the batteries in cycle use. This may shorten the life of the batteries by causing an imbalance in the charge/discharge operation of the batteries.

(5) Measure the total voltage of the batteries during trickle charge (or float charge), using a voltage meter. If the total voltage of the batteries provide an indication deviating from the specified voltage range, be sure to investigate the cause. If the total voltage is lower than that specified, the batteries may lose their capacity because of a lack of sufficient charge. However, if the total voltage is higher than that specified, the batteries may lose their capacity by damage due to overcharge and may suffer from "thermal runaway" and other accidents.

(6) Switch off the equipment after use to prevent loss of performance or shortened life of the batteries due to damage overdischarge.

(7) When storing the batteries, be sure to remove them from the equipment or disconnect them from the charger and the load to prevent overdischarge and loss of capacity. Before storing batteries, charge the batteries fully. Do not store batteries in a highly humid place to prevent rust from forming on the terminals.

### 6. Maintenance

#### WARNING

(1) When cleaning the batteries, use a soft damp cloth. A dry cloth may cause static electricity which could result in a fire or explosion.

(2) Replace batteries with the new ones before the end of their useful life as determined in the specifications. When the batteries near the end of their life (50% state of their initial discharge duration time) the remaining life will shorten remarkably. Finally the batteries will lose their available capacity by either drying out their electrolyte (causing increase in their internal resistance) or an internal short-circuit. In such case, if the batteries go on charging, thermal runaway and/or leakage of electrolyte may occur. The batteries should be replaced before reaching these conditions.

The expected life of the batteries (in trickle or float use) will decrease to half (50%) with each 10°C rise in temperature above 20°C. In particular, the life of the batteries will be shortened remarkably at approximately 40°C. Accordingly, precautions are required to prevent the use of batteries at high temperatures.

#### CAUTION

(1) Avoid using organic solvents such as thinner, gasoline, lamp oil or benzene and liquid detergent to clean the batteries. These substances may cause the battery containers to crack or leak.

#### REQUEST

(1) Keep the battery terminals clean in order to avoid interruption in the discharge and/or to maintain the charge.

## 1 | Precautions for Handling VRLA-Batteries

### 7. Treatment at Emergency

#### WARNING

(1) The batteries have toxic liquid - dilute sulfuric acid solution in them. If the acid comes into contact with skin or clothes, wash skin or cloth with lots of clean water to prevent scalding from occurring. If the acid should come into contact with the eyes, wash the eyes with lots of clean water and consult a physician immediately to prevent possible loss of sight.

#### CAUTION

(1) Check the batteries visually for any sign of irregularities in appearance. If any damage exists such as cracks, deformation, leakage of electrolyte, or corrosion, the batteries must be replaced with the new ones. Irregularities in the batteries could result in bodily injury, electrolyte leakage, excessive heat generation or explosion, if used. Furthermore, make sure the batteries are clean and free from dirt and dust.

### 8. Storage

#### CAUTION

(1) Store the batteries in a fixed position separate from metal or other conductive materials.

(2) Keep the batteries from rain water that could cause corrosion on the terminals of the batteries.

(3) Keep the batteries right-side-up during transportation and do not give any abnormally strong shock and jolt to the batteries. Transporting the batteries in an abnormal position or handling them roughly could destroy the batteries or cause their characteristics to deteriorate.

(4) When storing the batteries, be sure to remove them from the equipment or disconnect them from the charger and the load, then store them at room temperature or lower temperature. Do not store the batteries at direct sunlight, higher temperature or high humidity. To do so cause the batteries short life, performance deterioration or corrosion on terminals.

#### REQUEST

(1) Charge the batteries at least once every twelve months if they are stored at 20°C. Use the charge method specified in "3. Preparation Prior to Use". The interval of this charge should be reduced to 50% by each 10°C rise in temperature above 20°C. The self-discharge rate doubles for each 10°C in temperature. If they are stored for a long time in a discharged state, their capacity may not recover even after charge. If the batteries are stored for more than a year at room temperature, the life of the batteries may be shortened.

(2) Store the batteries starting from the fully charged state to prevent the life of the batteries being shortened.

(3) Use the batteries as quickly as possible after receiving them as they gradually deteriorate even under proper storage conditions.

### 9. Disposal and Recycling

#### CAUTION

(1) Please write the information about battery recycling on the equipment, the package, the carton, the instruction manual etc. in countries where legal or voluntary regulations on battery recycling are applicable.

(2) Design the equipment such that exchange and disposal of the batteries can be undertaken easily.

(3) Used batteries should be recycled. When returning used batteries, insulate their terminals using adhesive tape, etc. Even used batteries still have electrical charge and an explosion or a fire may occur, if proper insulation is not given on the terminals of the used batteries.

## 2 | General Information

### 1. Battery Construction

#### Positive plates

Positive plates are plate electrodes of which a grid frame of lead-tin-calcium alloy holds porous lead dioxide as the active material. The magnification of a positive active material is shown on following figure (1).

Fig. 1 Magnification of positive active material

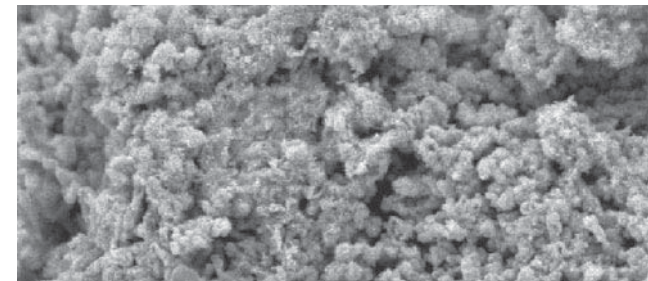

#### Negative plates

Negative plates are plate electrodes of which a grid frame of lead-tin-calcium alloy holds spongy lead as the active material. The magnification of a negative active material is shown on following figure (2).

Fig. 2 Magnification of negative active material

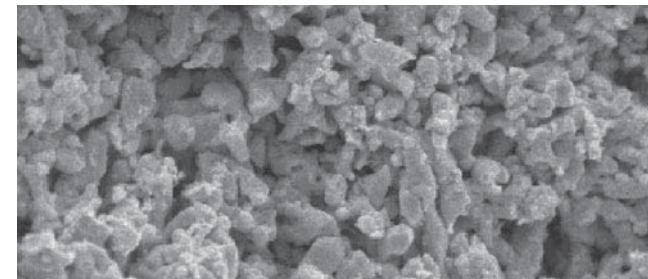

#### Electrolyte

Diluted sulfuric acid is used as the medium for conducting ions in the electrochemical reaction in the battery. Some additives are included to keep good recovery performance after deep discharge.

#### Separators

Separators, which retain electrolyte and prevent shorting between positive and negative plates, adopt a non-woven fabric of fine glass fibers which is chemically stable in the diluted sulfuric acid electrolyte. Being highly porous, separators retain electrolyte for the reaction of active materials

in the plates. Typical magnification of separator is shown in following figure (3).

Fig. 3 Typical magnification of separator

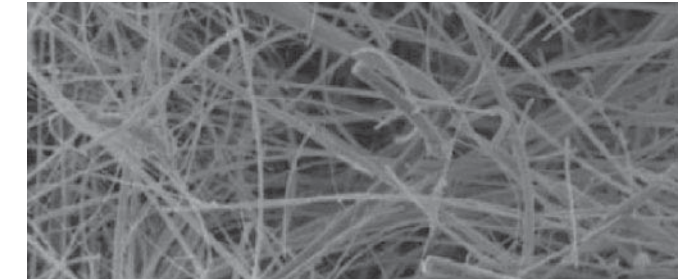

#### Vent (One way valve)

The valve is comprised of a one-way valve made of material such as neoprene. When gas is generated in the battery under extreme overcharge condition due to erroneous charging, charger malfunctions or other abnormalities, the vent valve opens to release excessive pressure in the battery and maintain the gas pressure within specific range (7.1 to 43.6 kPa). During ordinary use of the battery, the vent valve is closed to shut out outside air and prevent oxygen in the air from reacting with the active material in the negative electrodes.

#### Positive and negative electrode terminals

Positive and negative electrode terminals may be faston tab type, bolt fastening type or threaded post type, depending on the type of the battery. Sealing of the terminal is achieved by a structure which secures long adhesive-embedded paths and by the adoption of strong epoxy adhesives. For specific dimensions and shapes of terminals, see page 23.

#### Battery case materials and the design

Materials of the body and cover of the battery case are ABS resins, unless otherwise specified. Since the inside of VRLA battery is pressurized and depressurized, stress occurs at the container and cover. The design according to the stress is designed to accommodate the fluctuations in stress in the event the battery becomes deformed. The thickness of container, form, material and stress analysis are determined by utilization of computer aided engineering (CAE). This depicts the container design & strength. Destructive examinations using the molded container are also carried out. In other cases in which water in electrolysis liquid may penetrate through container in service life, the container design is put through



## 2 | General Information

water penetration tests.

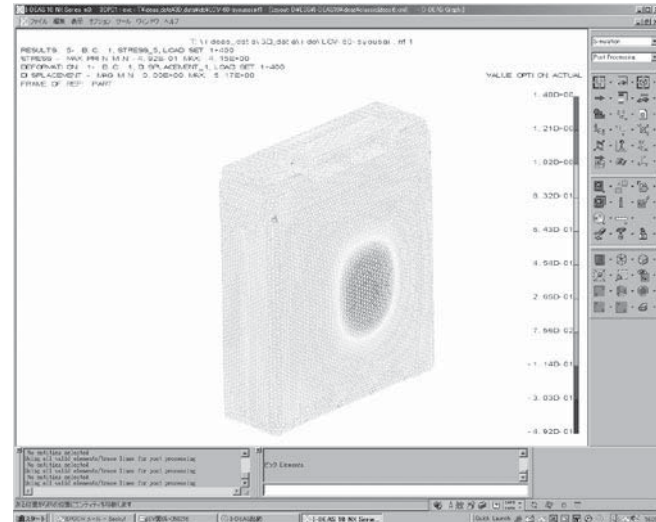

Battery case materials (example LC-R Series)

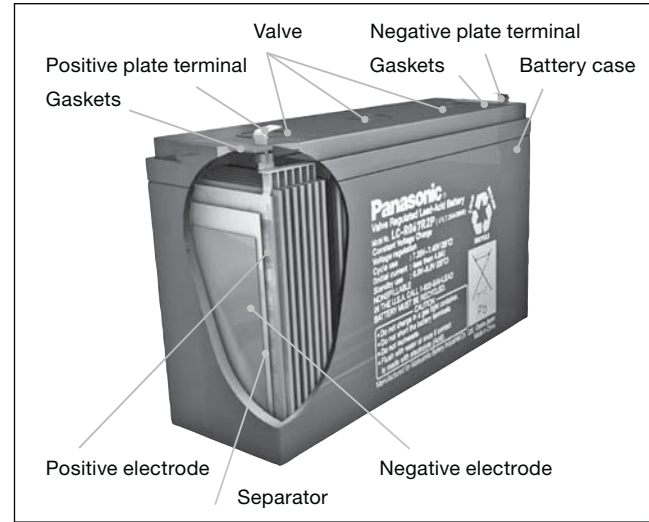

### 2. Electrochemical Reactions on Electrodes

The electrochemical reaction processes of the sealed lead-acid battery (negative electrode recombination type) are described below. Where “charge” is the operation of supplying the rechargeable battery with direct current from an external power source to change the active material in the negative

plates chemically, and hence to store in the battery electric energy in the form of chemical energy. “Discharge” is the operation of drawing out electric energy from the battery to operate external equipment.

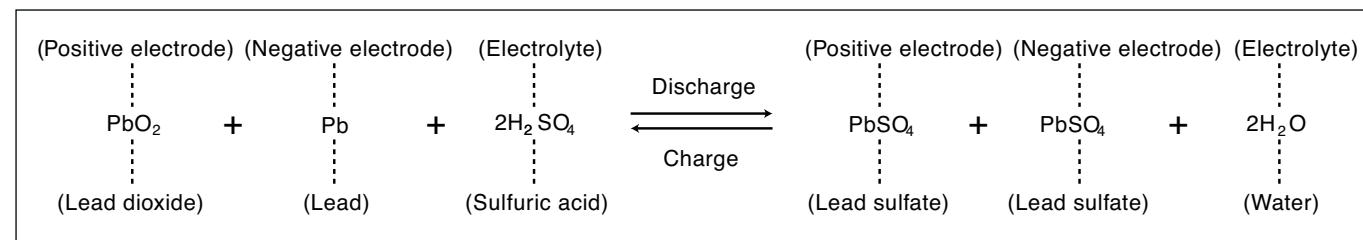

In the final stage of charging, an oxygen-generating reaction occurs at the positive plates. This oxygen transfers inside the battery, then is absorbed into the surface of the negative

plates and consumed. These electrochemical reaction processes are expressed as follows.

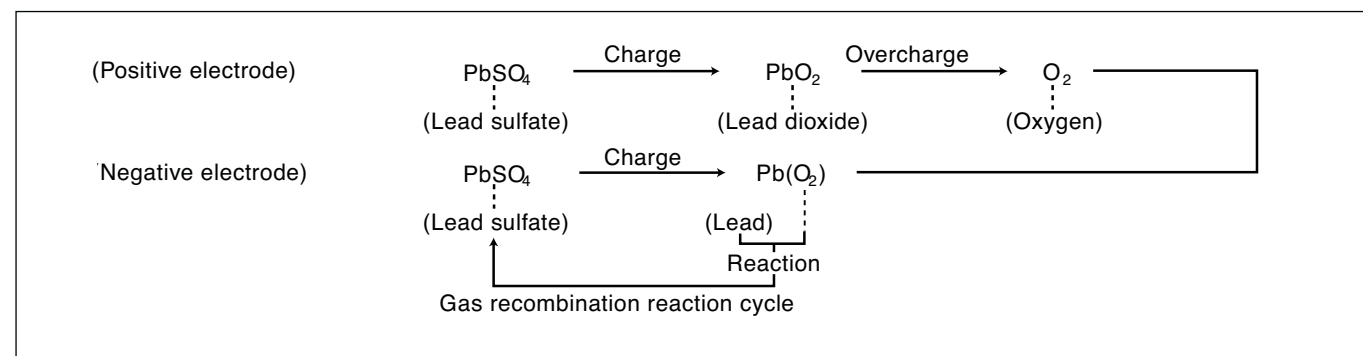

## 2 | General Information

### 3. Applications

#### Stand-by/Back-up power applications

- Communication equipment: base station, PBX, CATV, WLL, ONU, STB, etc.
- Back-up for power failure: UPS, ECR, computer system back-up, sequencers, etc.
- Energy saving: solar and/or wind powered lanterns, wind powered advertising displays etc.
- Emergency equipment: lights, fire and burglar alarms, radios, fire shutters, stop-position controls (for machines and elevators), etc.

#### Main power applications

- Electrically operated vehicles: picking carts, automated transports, electric wheelchairs, cleaning robots, electric automobiles, electric lawnmowers, etc.
- Tools and engine starters: grass shears, hedge trimmers, scouters, jet-skis, electric saws, etc.
- Industrial equipment/instruments and non life-critical medical equipment\*: measuring equipment, non life-critical medical equipment (electrocardio-graph), etc.
- Photography: camera strobes, VTR/VCR, movie lights, etc.
- Toys and hobby: radio-controllers, motor drives, lights, etc.
- Miscellaneous uses: integrated VTR/VCR, tape recorders, other portable equipment, etc.

\* (Note) When any medical equipment incorporating a Panasonic VRLA battery is planned, please contact Panasonic.

### 4. Features

#### Leak-resistant structure

A required-minimum quantity of electrolyte is impregnated into, and retained by, the positive and negative plates and the separators; therefore electrolyte does not flow freely. Also, the terminal has a sealed structure secured by long adhesive-embedded paths and by the adoption of strong epoxy adhesives which makes the battery leak-resistant. (Note) In stand-by/back-up uses, if the battery continues to be used beyond the point where discharge duration has decreased to 50% of the initial (i.e. life judgment criteria), cracking of the battery case may occur, resulting in leakage of the electrolyte.

#### Long service life

Service life of our long-life series (LC-P, LC-X series) is approximately double that of the conventional (LC-R and LC-L series) batteries (Temperature 20°C, discharge rate 0.25 CA/1.75V/cell, discharge frequency every 6 months, 2.30V/cell charge).

#### Easy maintenance

Unlike conventional batteries in which electrolyte can flow freely, VRLA batteries do not need the specific-gravity check of the electrolyte or the water top up maintenance, this allows the battery to function fully with the minimum of maintenance.

#### No sulfuric acid mist or gases

Unlike conventional batteries in which electrolyte can flow freely, VRLA batteries generate no Sulphuric acid mist or gases under Panasonic recommended use conditions. If used under conditions other than recommended then gas generation may occur, therefore do not design the battery housing in a closed structure.

#### Exceptional deep discharge recovery

Our VRLA batteries show exceptional rechargeability even after deep discharge, which is often caused by failure to turn off the equipment switch, followed by standing (approx. 1 month at room temperature is assumed).

### 3 | Characteristics

#### 1. Charging

Charge characteristics (constant voltage-constant current charging) of VRLA batteries are exemplified below.

##### Example of constant-voltage charge characteristics by current

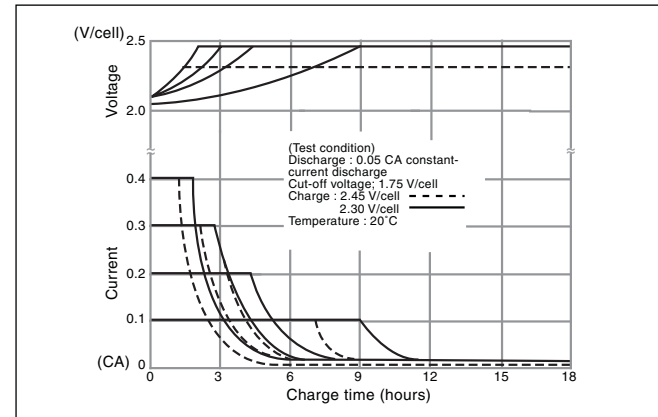

In order to fully utilize the characteristics of VRLA batteries, constant-voltage charging is recommended. For details of charging see pages 19 – 23.

#### 2. Discharging

##### a) Discharge current and discharge cut-off voltage

Recommended cut-off voltages for 6V and 12V batteries consistent with discharge rates are given in the figure below. With smaller discharge currents, the active materials in the battery work effectively, therefore discharge cut-off voltages are set to the higher side for controlling overdischarge. For larger discharge currents, on the contrary, cut-off voltages are set to the lower side. (Note) Discharge cut-off voltages given are recommended values.

##### Discharge current vs. Cut-off voltage

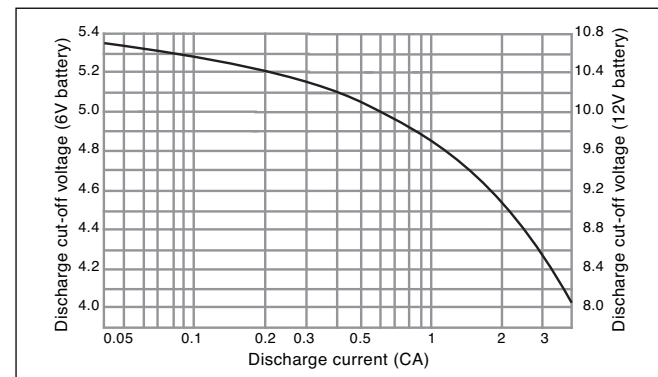

##### b) Discharge temperature

(1) Control the ambient temperature during discharge within the range from -15°C to 50°C for the reason described below.  
 (2) Batteries operate on electrochemical reaction which converts chemical energy to electric energy. The electrochemical reaction is reduced as the temperature lowers, thus, available discharge capacity is greatly reduced at temperatures as low as -15°C. For the high temperature side, on the other hand, the discharge temperature should not exceed 50°C in order to prevent deformation of resin materials which house the battery or deterioration of service life.

##### c) Effect of temperature on discharge characteristics

Available discharge capacity of the battery varies with ambient temperature and discharge current as shown in the figure below.

##### Discharge capacity by temperature and by discharge current

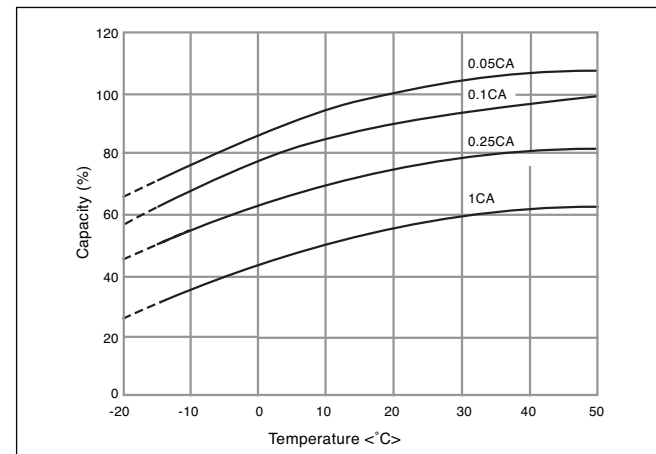

##### d) Discharge current

Discharge capability of batteries is expressed by the 20 hour rate (rated capacity). Select the battery for specific equipment so that the discharge current during use of the equipment falls within the range between 1/20 of the 20 hour rate value and 3 times that (1/20 CA to 3 CA): discharging beyond this range may result in a marked decrease of discharge capacity or reduction in the number of times of repeatable discharge. When discharging the battery beyond said range, please consult Panasonic in advance.

##### e) Depth of discharge

Depth of discharge is the state of discharge expressed by the ratio of amount of capacity discharged to the rated capacity.

### 3 | Characteristics

#### 3. Storage

##### a) Storage condition

Observe the following condition when the battery needs to be stored.

- (1) Ambient temperature: -15°C to 40°C (preferably below 30°C)
- (2) Relative humidity: 25 to 85%
- (3) Storage place free from vibration, dust, direct sunlight, and moisture.

##### b) Self discharge and refresh charge

During storage, batteries gradually lose their capacity due to self discharge, therefore the capacity after storage is lower than the initial capacity. For the recovery of capacity, repeat charge/discharge several times for the battery in cycle use; for the battery in trickle use, continue charging the battery as loaded in the equipment for 48 to 72 hours.

##### c) Refresh charge (Auxiliary charge)

When it is unavoidable to store the battery for 3 months or longer, periodically recharge the battery at the intervals recommended in the table below depending on ambient temperature. Avoid storing the battery for more than 12 months.

Storage temperature	Interval of auxiliary charge (refresh charge)
Below 20°C	12 months
20°C to 30°C	9 months
20°C to 40°C	6 months

##### d) Residual capacity after storage

The result of testing the residual capacity of the battery which, after fully charged, has been left standing in the open-circuit state for a specific period at a specific ambient temperature is shown in the figure below. The self discharge rate is very much dependent on the ambient temperature of storage. The higher the ambient temperature, the less the residual capacity after storage for a specific period. Self discharge rate almost doubles by each 10°C rise of storage temperature (Figure 1).

##### e) Open circuit voltage vs. residual capacity

Residual capacity of the battery can be roughly estimated by measuring the open circuit voltage as shown in the figure (2).

Fig. 1 Residual capacity test result

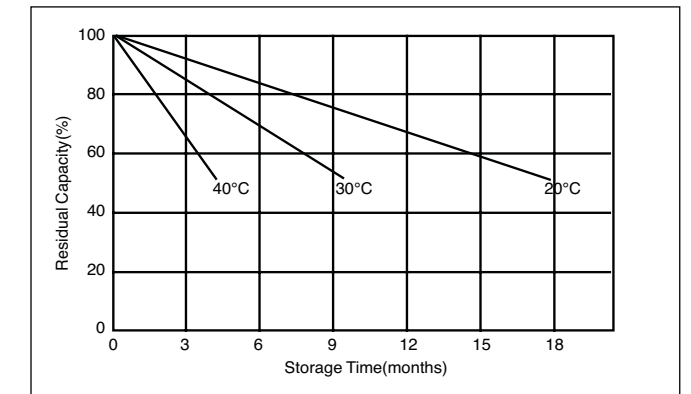
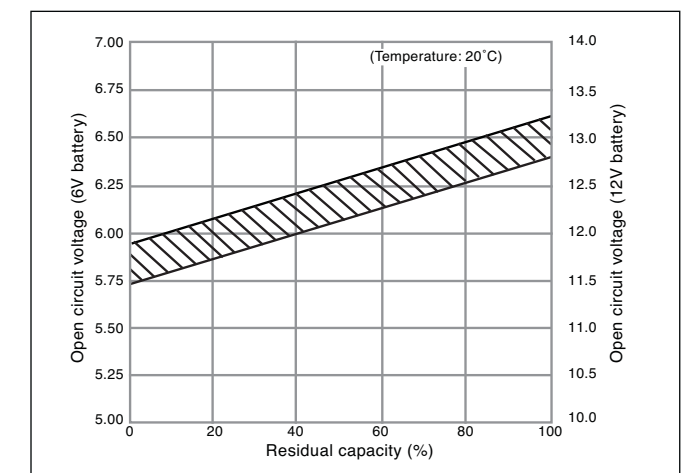
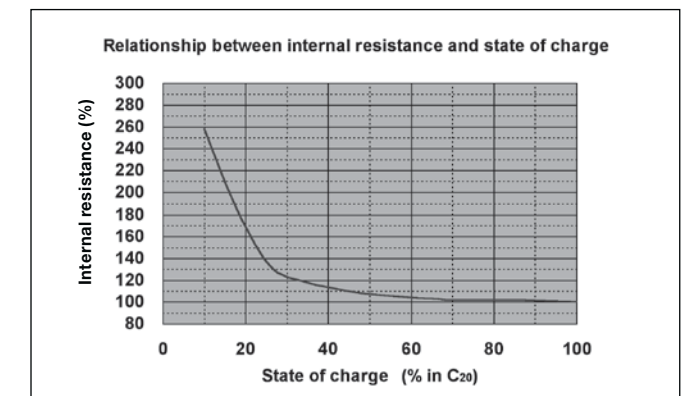

Fig. 2 Open circuit voltage vs. Residual capacity 20°C



#### 4. Internal Resistance

The internal resistance is an important parameter of batteries. Internal resistance varies with the state of charge of the battery and temperature as shown on the chart below.





### 3 | Characteristics

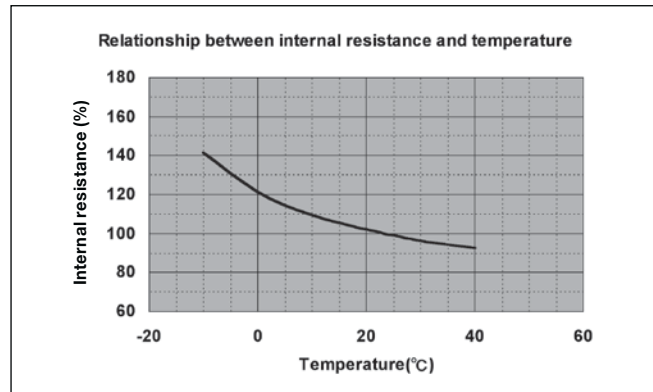

#### 5. Temperature conditions

Recommended temperature ranges for charging, discharging and storing the battery are tabulated below.

Charge	0°C ~ 40°C
Discharge	-15°C ~ 50°C
Storage	-15°C ~ 40°C

#### 6. Battery life

##### a) Cycle life

Cycle life (number of cycles) of the battery is dependent on the depth of discharge in each cycle. The deeper the discharge is, the shorter the cycle life (smaller number of cycles), providing the same discharge current. The cycle life (number of cycles) of the battery is also related to such factors as the type of the battery, charge method, ambient temperature, and rest period between charge and discharge. Typical cycle-life characteristics of the battery by different charge/discharge conditions are shown by the below figures. This data is typical and tested at a well-equipped laboratory. Cycle times are different for each battery model. Cycle times are also different from this data when using batteries under real conditions.

##### b) Trickle (Float) life

Trickle life of the battery is largely dependent on the temperature condition of the equipment in which the battery is used, and also related to the type of the battery, charge voltage and discharge current. The respective Figures show the influence of temperature on trickle life of the battery, an example of trickle (float) life characteristics of the battery, and the test result of the battery life in an emergency lamp.

#### Cycle life vs. Depth of discharge

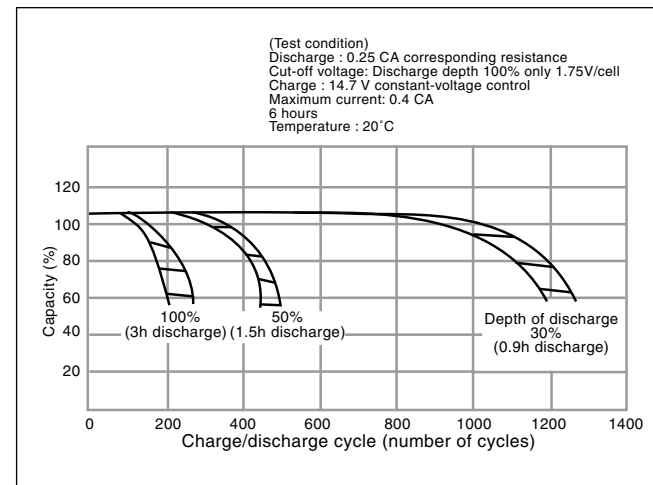

#### Influence of Temperature on Trickle life

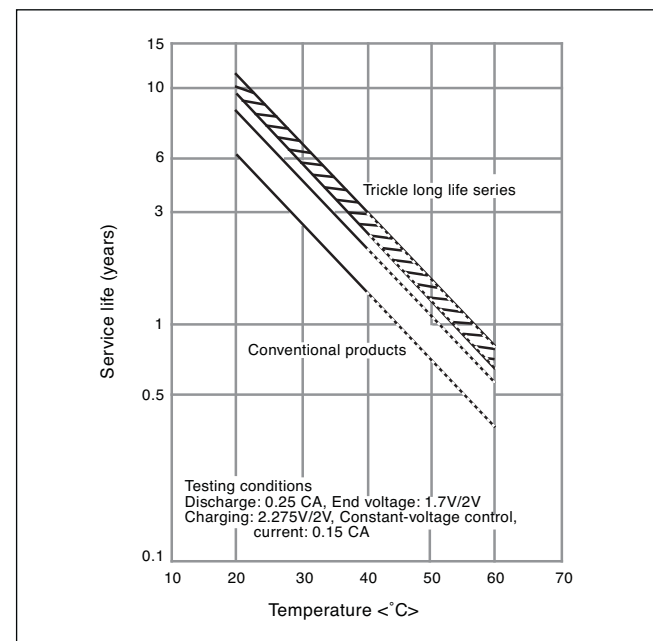

#### Trickle life characteristics at 50°C

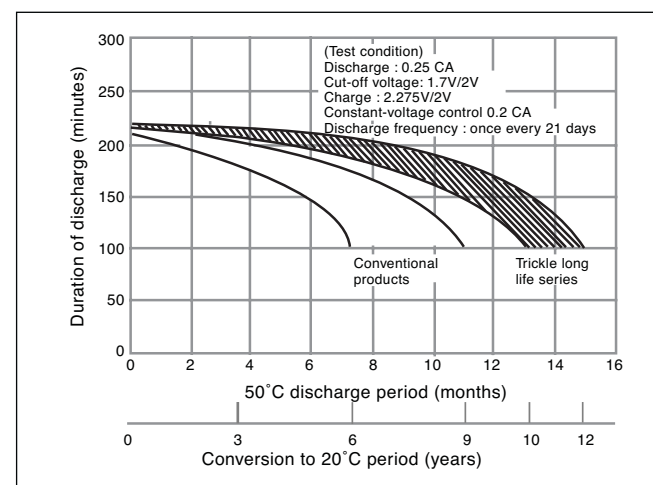

### 4 | Charging Methods

#### Methods of Charging the Valve Regulated Lead-Acid Battery

For charging the valve regulated lead-acid battery, a wellmatched charger should be used because the capacity and life of the battery is influenced by ambient temperature, charge voltage and other parameters. Charging methods are dependent on battery applications and are roughly classified into main power applications and stand-by/back-up power applications.

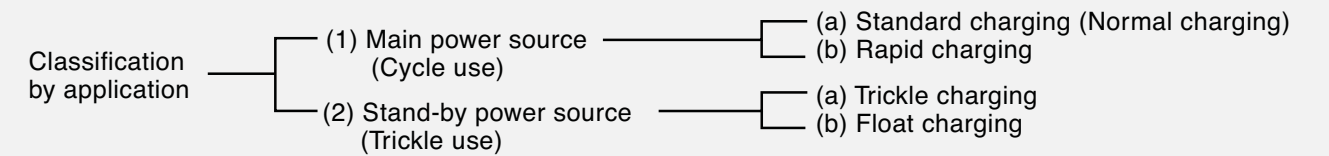

#### (1) Main Power cycle use

Cycle use is to use the battery by repeated charging and discharging.

##### (a) Standard charging (Normal charging)

For common applications of the battery, the constant voltage charge method is advantageous as it allows the battery to exert full performance.

##### • Constant voltage charging method

This method is to charge the battery by applying a constant voltage between the terminals. When the battery is charged by applying a voltage of 2.45 V per cell (unit battery) at a room temperature of 20°C to 25°C, charging is complete when the charge current continues to be stable for three hours. Valve regulated lead-acid batteries can be overcharged without constant voltage control. When the battery is overcharged, the water in the electrolyte is decomposed by electrolysis to generate more oxygen gas than what can be absorbed by the negative electrode. The electrolyte is changed to oxygen gas and hydrogen gas, and lost from the battery system. As the quantity of electrolyte is reduced, the chemical reactions of charge and discharge become inefficient and hence the battery performance is severely deteriorated. Therefore, exact voltage control and proper charging time in constant voltage charging are essential for securing the expected life of the battery.

##### • Constant voltage and constant-current charging method

This method is to charge the battery by controlling the current at 0.4 CA and controlling the voltage at 2.45 V / per cell at a room temperature of 20°C to 25°C. Proper charging time is 6 to 12 hours depending on depth of discharge.

#### Constant voltage constant-current charge characteristics

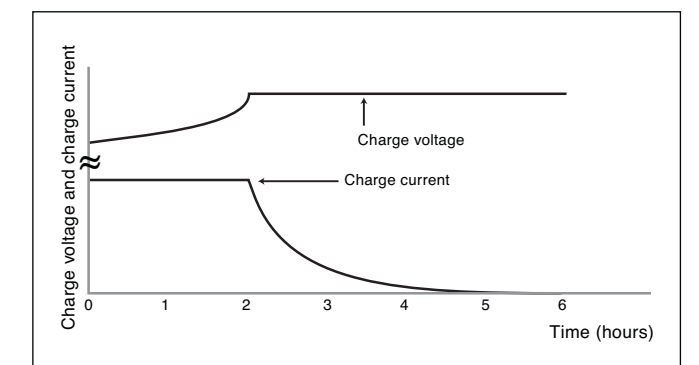

##### (b) Rapid charging

When rapidly charging the battery, a large charge current is required in a short time for replenishing the energy which has been discharged. Therefore, some adequate measures such as the control of charge current is required to prevent overcharging when the rapid charging is complete. Basic requirements for rapid charging are as follows:

- Sufficient charging should be made in a short time for fully replenishing the amount discharged.
  - Charge current should be automatically controlled to avoid overcharge even on prolonged charging.
  - The battery should be charged adequately in the ambient temperature range of 0°C to 40°C.
  - Reasonable cycle life of charge/discharge should be secured.
- Typical methods to control charging so as to satisfy the above requirements follow.

##### • Two-step constant voltage charge control method

Two-step constant voltage charge control method uses two constant-voltage devices. At the initial stage, the battery is charged by the first constantvoltage device SW(1) of high setup voltage (setup for cycle charge voltage). When the

## 4 | Charging Methods

charge current has reduced to the preset value, the device is switched over to the second SW(2) of low set-up voltage (setup for trickle charge voltage). This method has the advantage that the battery in trickle use can be charged in a comparatively short time for the next discharge.

### Charging characteristics of the two-step constant voltage control charger

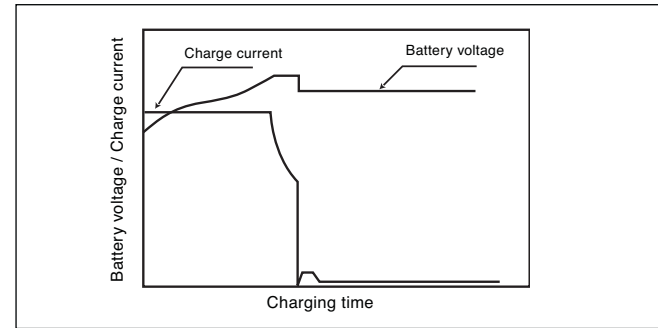

### Block diagram of the two-step constant voltage control charger

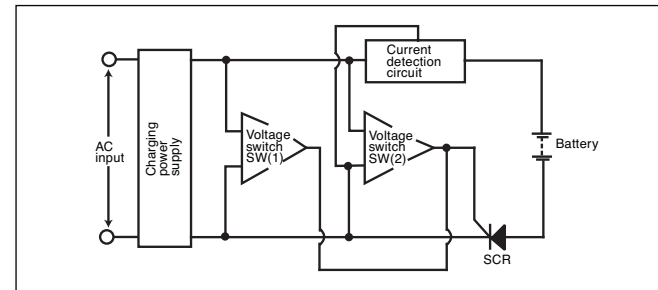

#### (2) Stand-by/Back-up use (Trickle use)

The application load is supplied with power from AC sources in normal state. Stand-by/back-up use is to maintain the battery system at all times so that it can supply power to the load in case the AC input is disrupted (such as a power failure). There are two methods of charging for this use.

#### (a) Trickle charge (Compensating charge)

##### Trickle charge

In this charge system, the battery is disconnected from the load and kept charged with a small current only for compensating self discharge while AC power is alive. In case of power failure, the battery is automatically connected to the load and battery power is supplied. This system is applied mainly as a spare power source for emergency equipment. In this use, if rapid recovery of the battery after discharge is required, it is necessary to consider the recovery charge with a comparatively large current followed by trickle charge, or alternative measures. While the type and capacity of the battery is de-

termined by the back-up time and the load (current consumption) during power failure, some reserve power should be taken into account considering such factors as ambient temperature, capability of the charger and depth of discharge.

### Trickle charge system model

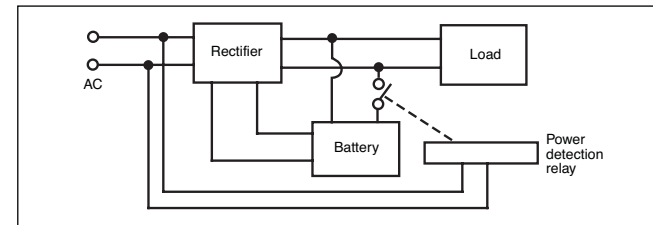

#### (b) Float charge

Float system is the system in which the battery and the load are connected in parallel to the rectifier, which should supply a constant power.

### Float charge system model

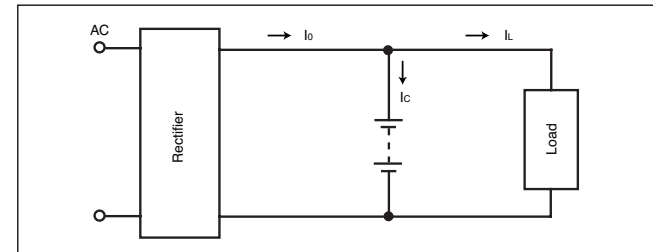

In the above-illustrated model, output current of the rectifier is expressed as:  $I_o = I_c + I_L$  where  $I_c$  is charge current and  $I_L$  is load current. Consideration should be given to secure adequate charging because, in fact, load current is not constant but irregular in most cases.

In the float system, capacity of the constant-voltage power source should be more than sufficient against the load. Usually, the rectifier capacity is set at the sum of the normal load current plus the current needed in order to charge the battery.

#### (Precautions on charging)

- As the battery continues to be charged over a long period, a small difference in charging voltage may result in a significant difference in the battery life. Therefore, charge voltage should be controlled within a narrow range and with little variation for a long period.
- As charge characteristics of the battery are dependent on temperature, compensation for temperature variation is required when the battery is used over a broad temperature range, and the system should be designed so that the battery and the charger are kept at the same temperature.

## 4 | Charging Methods

### Charging Methods and Applications of VRLA-Batteries

Application/ Charging Method	Normal charging in 6 or more hours; Constant voltage control	Two-step constant voltage control	Constant Current Control
Cycle Use	Control voltage: 7.25 to 7.45V / 6V battery 14.5 to 14.9V / 12V battery Initial current: 0.4 CA or smaller		
Trickle Use	Control voltage: 6.8 to 6.9 / 6V battery 13.6 to 13.8V / 12V battery	Initial charging with current of approx. 0.15 CA, followed by switching voltage to trickle charge	
Float Use	Control voltage: 6.8 to 6.9/6V battery; 13.6 to 13.8V / 12V battery. Float charging compensates for load fluctuations.		
Refresh charge (Auxiliary charge)*	When charging two or more batteries at a time, select only those which have been left under the same condition.		Charging with current of approx. 0.1 CA
Application example	General uses, Cellular phones (bag phones), UPS, Lanterns, Electric tools	Medical equipment, Personal radios	

Note \* Refresh (auxiliary) charge amount should be 120 to 130% of self-discharge amount. For details, please contact us.

#### (Precautions on charging)

- (a) in constant voltage charging (cycle use): Initial current should be 0.4 CA or smaller (C: rated capacity)  
(b) in constant voltage charging (trickle use): Initial current should be 0.15 CA or smaller (C: rated capacity)
- Relation between standard voltage value in constant voltage charging and temperature is given in the Table.

#### Relation between standard voltage value in constant voltage charging and temperature

		0°C	20°C	40°C
Cycle use	6V	7.7	7.4	7.1
	12V	15.4	14.7	14.2
Trickle use	6V	7.1	6.8	6.7
	12V	14.1	13.7	13.4

#### a) Temperature compensation of charge voltage

Charge voltage should be compensated to the ambient temperature near the battery, as shown by the figure below. Main reasons for the temperature compensation of charge voltage are to prevent the thermal runaway of the battery when it is used in high temperature conditions and to secure sufficient charging of the battery when it is used in low temperature conditions. Prolongation of service life of the battery by the above-described temperature compensation is expected as follows

- At 30°C: prolonged by approx. 5%
- At 35°C: prolonged by approx. 10%
- At 40°C: prolonged by approx. 15%

In low temperature zones below 20°C, no substantial prolongation of the battery life can be expected by the temperature compensation of charge voltage.

#### Compensated voltage value

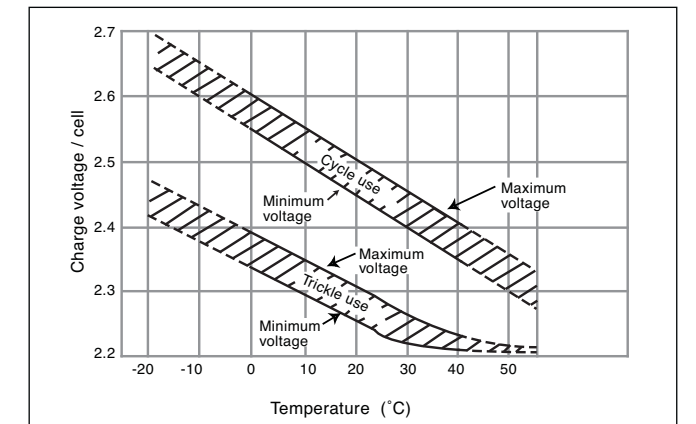

#### b) Charging time

Time required to complete charging depends on factors such as depth of discharge of the battery, characteristics of the charger and ambient temperature. For cycle charge, charging time can be estimated as follows:

- when charge current is 0.25 CA or greater:

$$Tch = Cdis / I + (3h \text{ to } 5h)$$

- when charge current is below 0.25 CA:

$$Tch = Cdis / I + (6h \text{ to } 10h), \text{ where}$$

Tch : Charging time required (hours),

Cdis : Amount of discharge before this charging (Ah)

I : Initial charge current (A)

Time required for trickle charge ranges from 24 to 48 hours.



## 4 | Charging Methods

### c) Charging temperature

- Charge the battery at an ambient temperature in the range from 0°C to 40°C.
- Optimum temperature range for charging is 5°C to 35°C.
- Charging at 0°C or below and 40°C or higher is not recommended: at low temperatures, the battery may not be charged adequately; at high temperatures, the battery may become deformed.
- For temperature compensation values, see a).

### d) Reverse charging

Never charge the battery in reverse, as it may cause leakage, heating or bursting of the battery.

### e) Overcharging

Overcharge is an additional charge after the battery is fully charged. Continued overcharging shortens the battery life. Select a charge method which is specified or approved for each application.

### f) Charging before use

Recharge the battery before use to compensate for capacity loss due to self-discharge during storage. (See "Refresh charge" (auxiliary charge) table on page 15.)

### Characteristics of constant voltage chargers

Even with the same voltage set-up, charging time varies with output V-I characteristics.

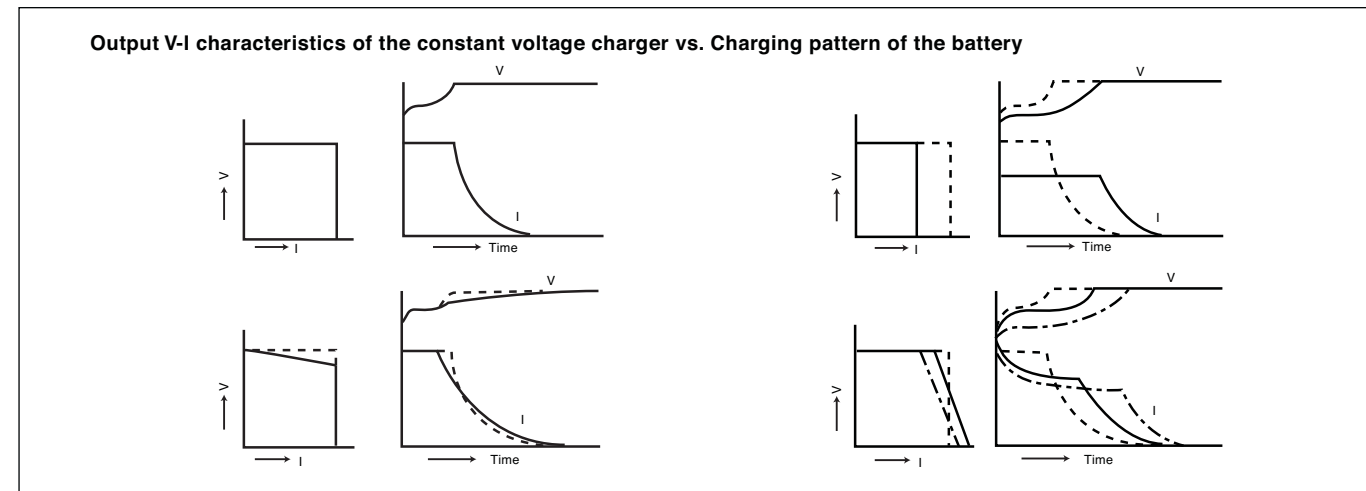

### Constant voltage charger circuitry (Concept diagram)

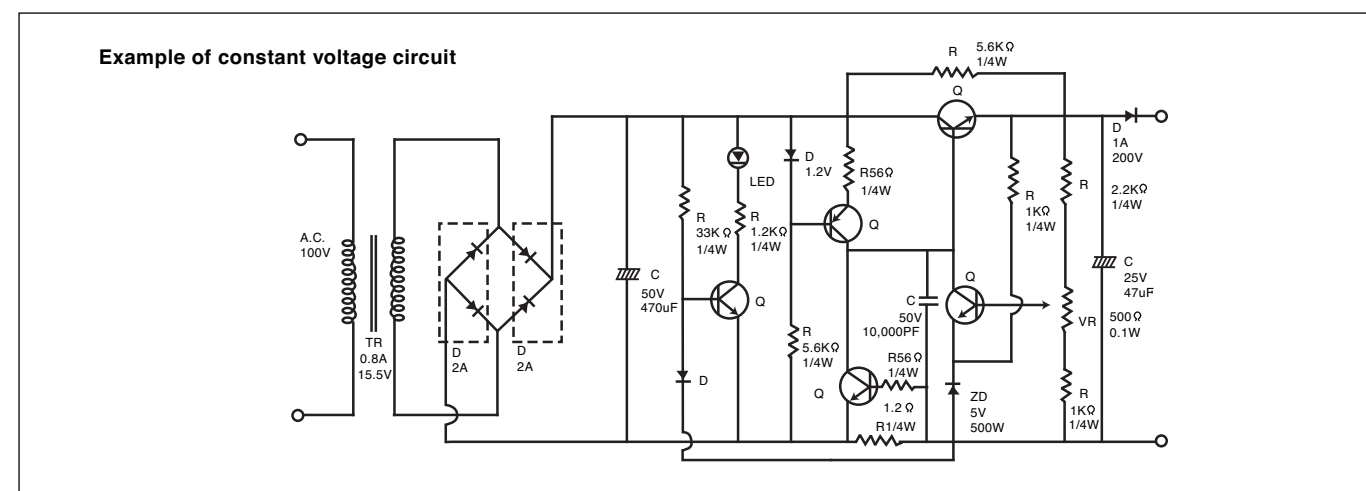

## 4 | Charging Methods

### Precautions

- When adopting charging methods and charging conditions other than those described in the specifications or the brochures, thoroughly check charging/discharging characteristics and life characteristics of the battery in advance. Selection of appropriate methods and conditions of charging is essential for safe use of the battery and for fully utilizing its discharge characteristics.
- In cyclic use of the battery, use a charger equipped with a charging timer or a charger in which charging time or charge amount is controlled by other means; otherwise, it will be difficult to judge the completion of the charge. Use of a charger as described above is recommended to prevent undercharge or overcharge which may cause deterioration of the battery characteristics.

- Continue charging the battery for the specified time or until the charge completion lamp, if equipped, indicates completion of charging. Interruption of charging may cause a shortening of service life.
- Do not recharge the fully charged battery repeatedly, as overcharge may accelerate deterioration of the battery.
- In cyclic use of the battery, do not continue charging for 24 hours or longer, as it may accelerate deterioration of the battery.
- In cyclic service of the battery, avoid charging two or more batteries connected in parallel simultaneously: imbalance of charge/discharge amount among the batteries may shorten the life of batteries.

## 5 | Terminal Data

### 1. Bold and Nut type

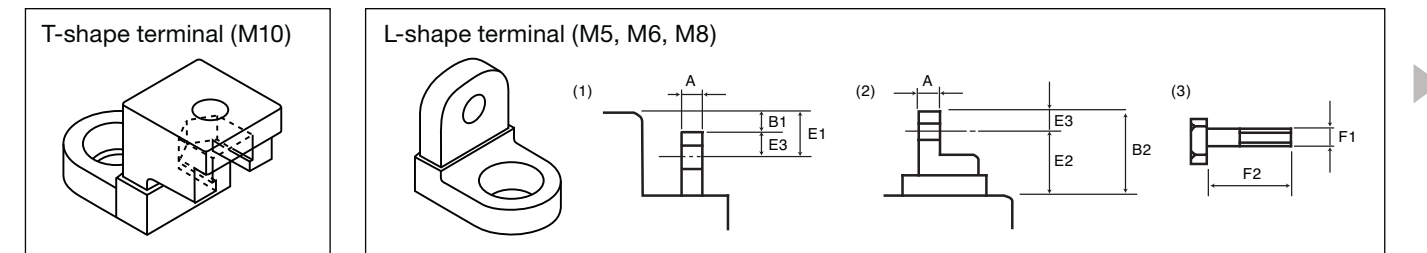

Type of Terminal	Terminal thickness A (1)	Height from battery case top		Terminal width	Hole diameter	Hole Position			Bolt		
		B1 (1)	B2 (2)			Distance from top: E1 (1)	Distance from top: E2 (2)	Distance from terminal top: E3 (2)	Diameter F1 (3)	Pitch	Length F2 (3)
M5 bolt and nut	5.0 ± 0.3	1.0	-	11 ± 0.4	5.5 ± 0.3	6.5	-	5.5 ± 0.3	M5	P = 0.8	15 ± 1.0
M6 bolt and nut	8.0 ± 0.5	5.0	16.5 ± 1.5	16 ± 0.8	6.5 ± 0.4	-	9 ± 1.0	7.5 ± 0.4	M6	P = 1.0	20 ± 1.0
M8 bolt and nut	8.0 ± 0.5	-	24 ± 1.5	-	6.5 ± 0.4	-	14 ± 1.0	10 ± 0.4	M8	P = 1.25	20 ± 1.0

### 2. Faston tab type

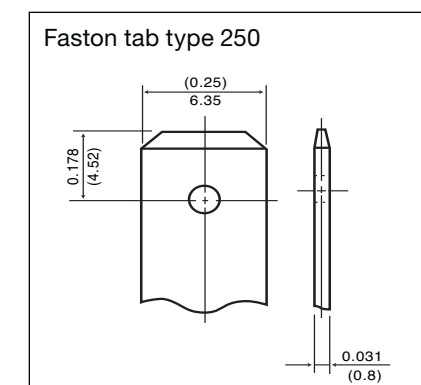
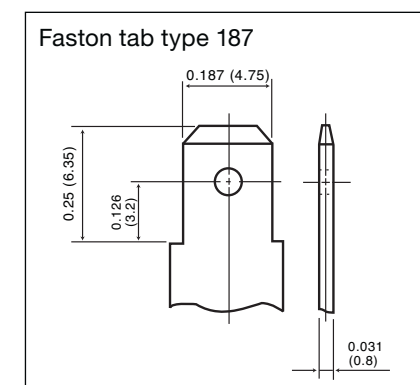

### 3. Threaded post type

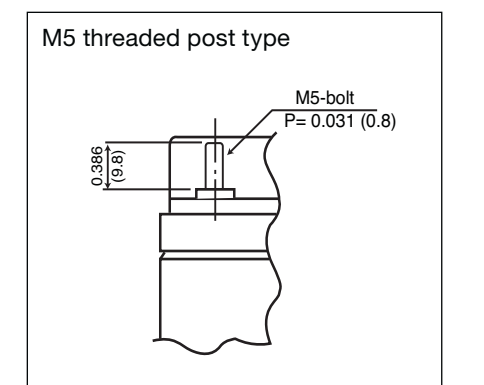

## 6 | Safety

### VRLA battery safety test items

Item	Test method	Check point
<b>1. Shock test (Drop test)</b> IEC 61056-1 and JIS C 8702 (These specifications are harmonized each other)	A fully charged battery is allowed to drop in the upright position from the height of 20 cm onto a hard board having a thickness of 10 mm or more. Test is repeated three times.	The battery should be free from noticeable breakage or leaks; and its terminal voltage should be held higher than the nominal voltage.
<b>2. Vibration test</b> IEC 61056-1 and JIS C 8702 (These specifications are harmonized each other)	A vibration frequency 1000 times/minute and amplitude 4 mm is applied to the X-, Y- and Z-axis directions of a fully charged battery for 60 minutes respectively.	No battery part should be broken; the battery should be free from leaks; and its terminal voltage should be held higher than the nominal voltage.
<b>3. Oven test</b> Panasonic internal standard	A fully charged battery is left standing in an atmosphere of 70°C for 10 hours.	The battery case should not be deformed; the battery should be free from leaks.
<b>4. Coldproof test</b> Panasonic internal standard	A fully charged battery is connected to a resistor equivalent to 60 hour rate discharge and left for 4 days; then the battery is left standing in an atmosphere of -30°C for 24 hours.	No crack should develop in the battery case; the battery should be free from leaks.
<b>5. Heat cycle test</b> Panasonic internal standard	A fully charged battery is exposed to 10 cycles of 2 hours at -40°C and 2 hours at 65°C.	No crack should develop in the battery case; the battery should be free from leaks.
<b>6. Short circuit test</b> Panasonic internal standard	A fully charged battery connected with a small resistor of 10 ohms or less is allowed to discharge.	The battery must not burn nor bust.
<b>7. Large current discharge test</b> Panasonic internal standard	A fully charged battery is allowed to discharge at 3CA to 4.8V / 6V battery level. (This test is not applicable to batteries having built-in thermostat.)	The battery should not burn or bust, and it should be free from battery case deformation, leaks and any irregularity internal connections.
<b>8. Vent valve function test</b> UL1998	A fully charged battery is submerged in liquid paraffin in a container, then overcharged at 0.4CA. (UL1989)	Release of gas from the vent should be observed.
<b>9. Overcharge test</b> Panasonic internal standard	A fully charged battery is overcharged at 0.1CA for 48 hours, left standing for one hour, and allowed to discharge at 0.05CA to 5.25V / 6V.	No irregularity should be noticed in the battery appearance; the battery should retain 95% or more of the initial capacity.

(Note) The above safety notes apply only to standalone batteries, not to embedded batteries.

## 7 | Safety Design

### Vent (One way valve)

If the internal pressure of the battery is raised to an abnormal level, the rubber one way valve opens to release excessive pressure; thus the valve protects the battery from danger of bursting. Since the rubber valve is instantly resealable, the valve can perform its function repeatedly whenever required.

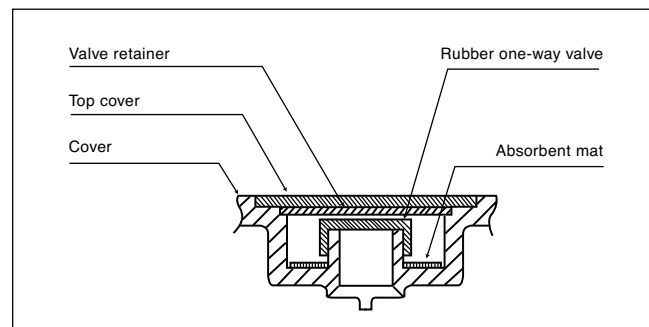

Example of Valve Construction

## 7 | Safety Design

VRLA batteries are inherently safe. However, there are some risks when VRLAs are used beyond a reasonable replacement time span, misapplied or abused. There are two main failure mode of VRLA battery used for trickle (float) application. In high temperatures and/or high voltage charging, dry-out is accelerated. This leads to loss of capacity and eventually the cell will fail open. Grid growth due to grid corrosion causes loss in mechanical strength and eventually leads to loss of contact with the grid. Battery should be replaced before these failures. If VRLA batteries are used after the end of life, the grid growth may cause a crack of container. Capillary action can result in a slight film of conductive electrolyte forming around the crack even though VRLA batteries contain significantly lower volumes of electrolyte and the electrolyte is immobilized. This electrolyte film will be in contact with an un-insulated metal component and this ground fault current could result in thermal runaway of a portion of the string or even a fire. And the grid growth may cause internal short between positive grid and negative strap in a cell. Continuing to charge a string of cells when one or more of the cells exhibit internal shorts, can result in thermal runaway. For example, assume a string of 12 cells is being charged at 27.3V (2.275V/cell) and the string continues in operation with two cells shorted. In this situation the average charging voltage on the remaining 10 good cells is 2.73V/cell. This will result in very high float current and cause thermal runaway.

Figure 1 is the mechanism of above phenomena.

Panasonic VRLA battery minimizes these risks by using less corrosive lead alloy and expanded positive grid. Figure 2 shows an example of cast grid and expanded grid. Expanded grid does not have enough strength to crack container case by grid growth. And an insulator between positive grid and negative strap is installed in the models as necessary.

Furthermore, Panasonic uses flame retardant battery container case for the models used for stand-by application. The cases are designed to be self-extinguishing and meet minimum flammability standards of UL94 V-0 and 28 L.O.I. (limiting oxygen index).

Figure 3 is the picture of self-extinguishing phenomenon.

Fig. 1 Mechanism of thermal runaway caused by grid growth

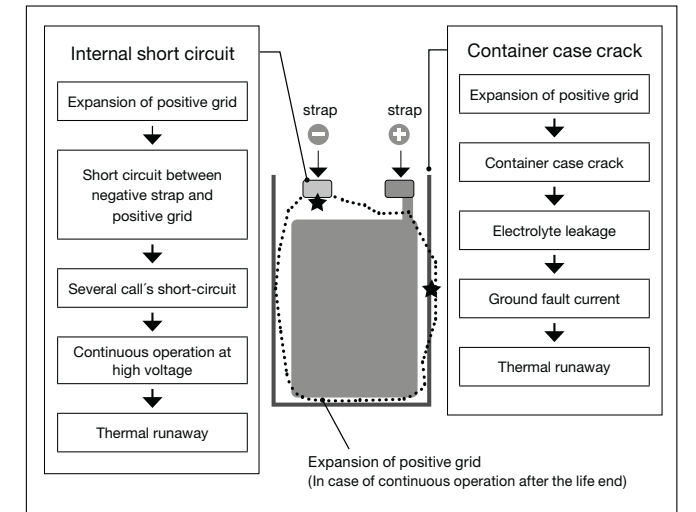

Fig. 2 Cast grid and expanded grid

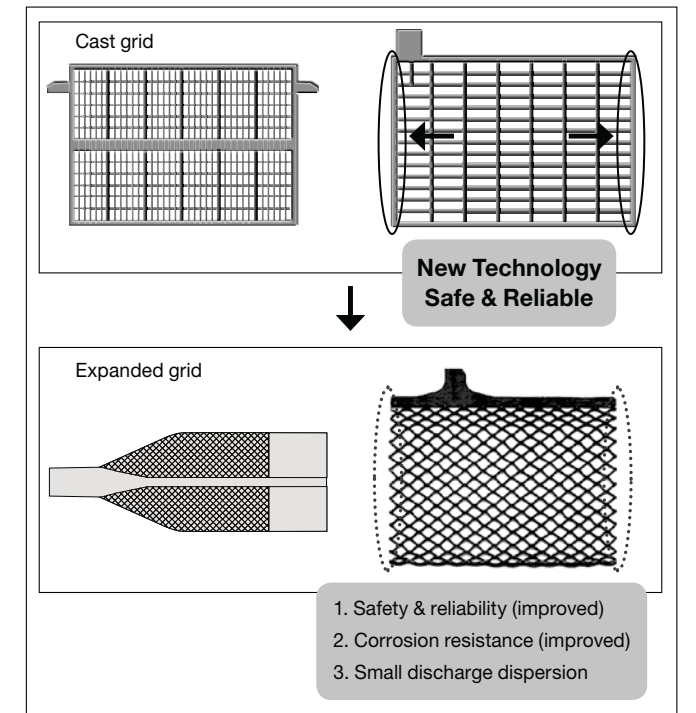
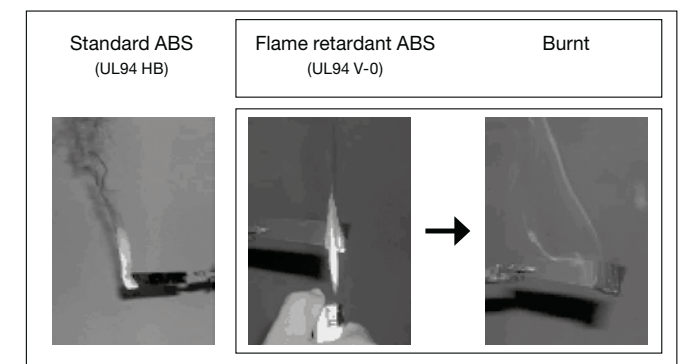

Fig. 3 Flame retardant case (Self-extinguish phenomenon)





## 8 | Model Numbers of VRLA-Batteries

### Composition of Model Numbers

Figure No.	1	2	3	4	5	6	7	8	9	10	11	12
Model No.	L	C	-	⊗	⊗	⊗	⊗	⊗	⊗	⊗	⊗	⊗

⊗ Corresponding model number descriptions are listed below.  
Please refer to the battery indexes for listings of available models.

#### No. 1 to 3

Product division codes (all of which are assigned by Panasonic). "LC" means Panasonic Valve Regulated Lead-Acid batteries.

#### No. 4

Fixed single-figure code (alphabetic letter) indicating properties, shape, etc. of the battery

- XC: Cycle long life products**
- X: Trickle long life products**
- P: Products combining trickle long life and flameretardant battery case**
- R: Small-sized common products (Under 17Ah)**
- V: Products of "R" and "L" types with flameretardant battery case (option)**

#### No. 5

Single code (alphabetic letter) for dividing products of the same type and the same capacity but having different shapes. (This figure may be omitted when not applicable, then the proceeding codes are advanced.)

**Examples:** LC-RD LC-XB

#### No. 5 to 7

Double-figure fixed codes indicating nominal voltage by numerical value.

**Examples:** 6V = 06, 12V = 12, etc.

#### No. 7 to 10

One- through four-figure (maximum) codes indicating capacity by numbers: decimal point is expressed by R (When some codes are not applicable, the proceeding codes are advanced.)

<b>Examples:</b>				
<b>Capacity (20 hour rate)</b>	4Ah	7.2Ah	12Ah	100Ah
	↓	↓	↓	↓
<b>Model Number</b>	4	7R2	12	100

#### No. 8 to 12

One- through five-figure (maximum) alphanumeric code for classifying products by terminal type, package form, destination code, etc.

**Examples:** P: English label  
J: Japanese label  
G: VdS certified products

(Note) 1) Country codes are subject to change.

## 8 | Model Numbers of VRLA-Batteries

### Composition of Model Numbers

UP-RW series (High power batteries for UPS)

Figure No.	1	2	3	4	5	6	7	8	9	10	11	12
Model No.	U	P	-	*	W	□	□	◇	◇	◇	◇	◇

#### No. 1 to 3

Production division codes of high power batteries for UPS.

#### No. 4

Alphanumeric code indicates properties, shape, etc. of the battery.

**R: Back-up power sources series.**

#### No. 5

Indication of wattage.

#### No. 6

Single alphabetic letter for dividing products of the same type and the same capacity but having different shapes. (This figure may be omitted when not applicable, then the proceeding codes are advanced.)

**Examples:** UP-RW, UP-RWA

#### No. 6 to 8

Double-figure fixed codes indicating nominal voltage by numerical value.

**Examples:** 12V = 12, 24V = 24

#### No. 8 to 10

Indicating wattage at 2V, 10 minute rate discharge.

#### No. 10 to 12

One-through five-figure (maximum) alphanumeric code for classifying products by terminal type, package form, destination code, etc.

**Examples:** J: Japanese label  
P: English label  
1: Faston 250

(Note) The last numbers of model number changes depending on the country of destination. Please consult Panasonic for more details. Division codes are subject to change.

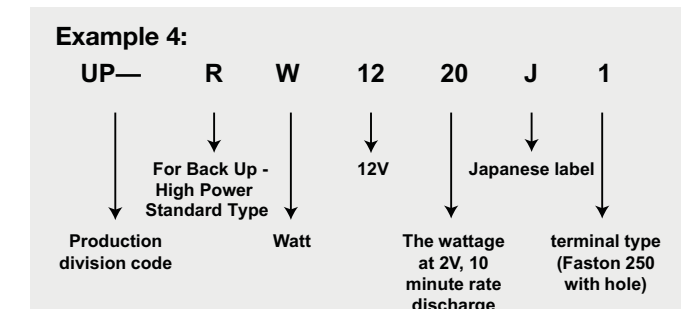
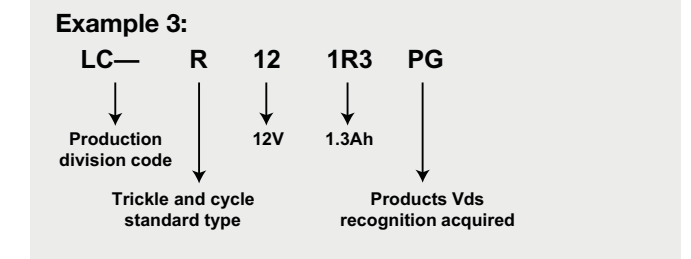
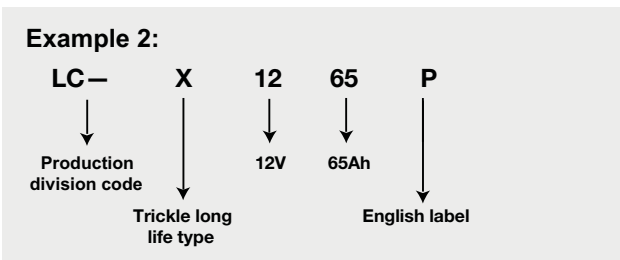
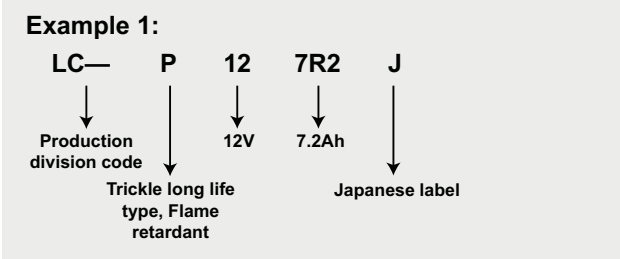

## 9 | Battery Selection Chart

Method of battery selection (Estimation of initial discharge time)

- (1) Determine discharge current.
- (2) Determine duration of discharge required.
- (3) Select batteries from the selection chart below. Then, select a battery which meets the specification of the equipment in which the battery is loaded such as voltage, dimensions and mass, from the "Battery Index" on page 28 to 29.

(4) Example

- Use condition: 2.9 A, 1.5 hours, 12 V; space allowable 100 mm x 160 mm x 105 mm
- 7.2 Ah is selected in the step (3).
- LC-R127R2P 94 mm x 151 mm x 100 mm is selected in the step (4).

(5) Refer to individual data sheets for detailed discharge characteristics of the battery.

(Note) Data given are the average values obtained within three cycles of charge/discharge, not the minimum values.

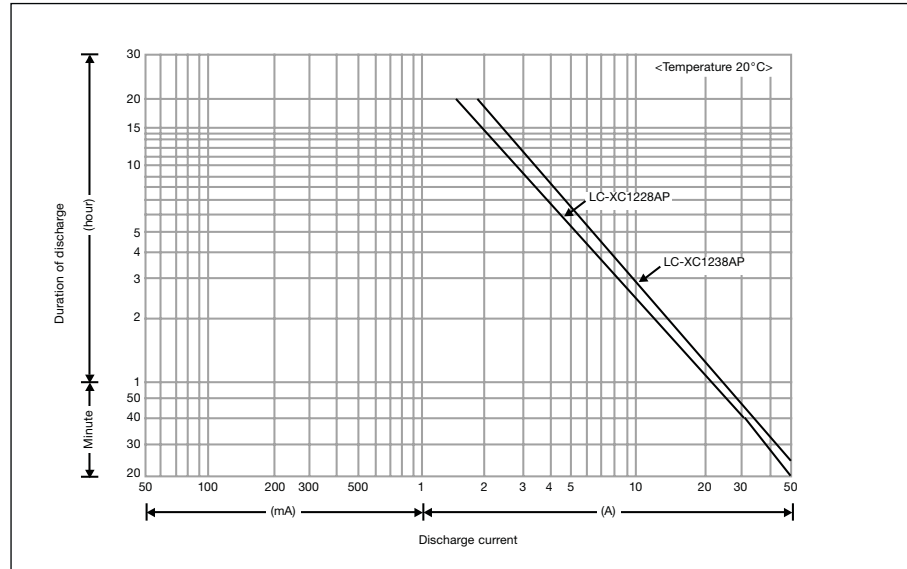

**VRLA battery for main power applications**

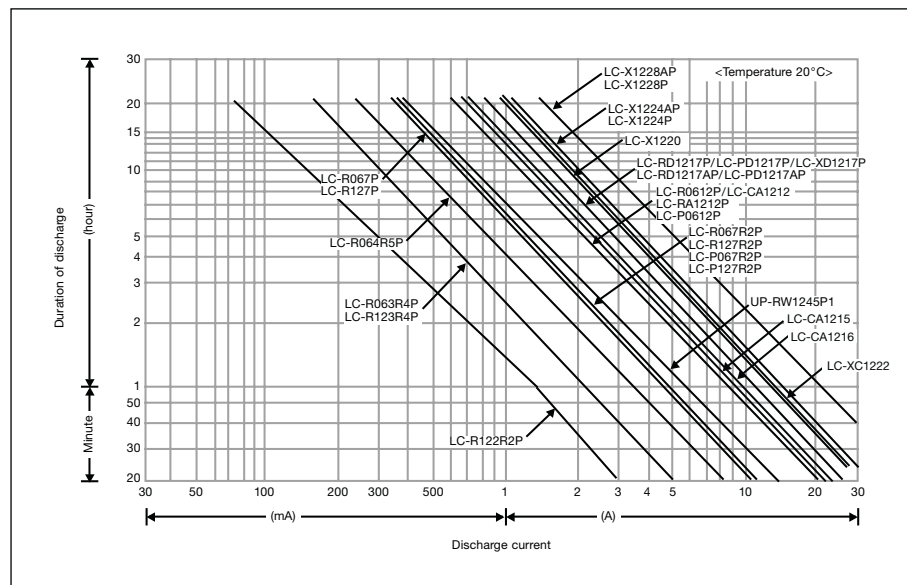

**VRLA battery for standby power applications (2.2 Ah to 28 Ah)**

## 9 | Battery Selection Chart

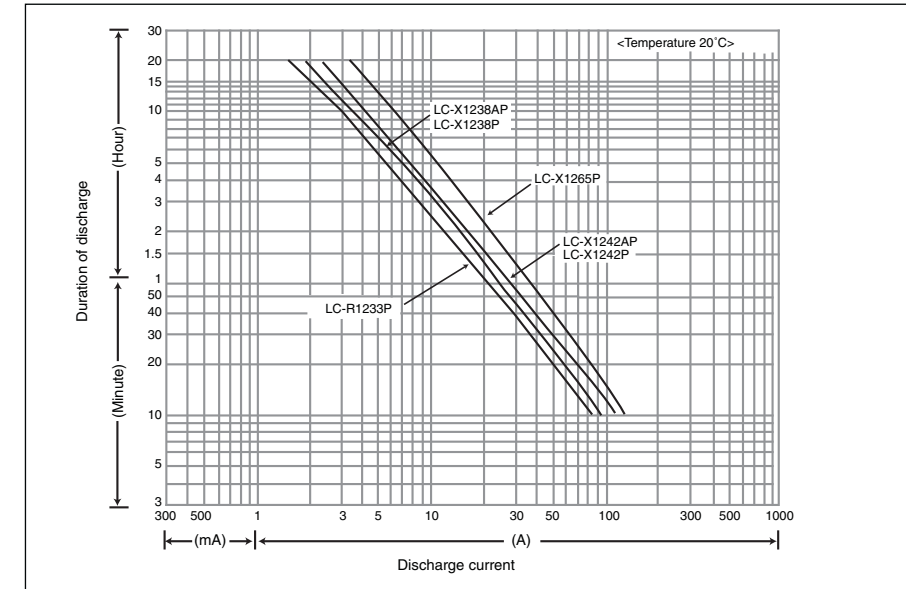

**VRLA battery for standby power applications (33Ah to 65Ah)**

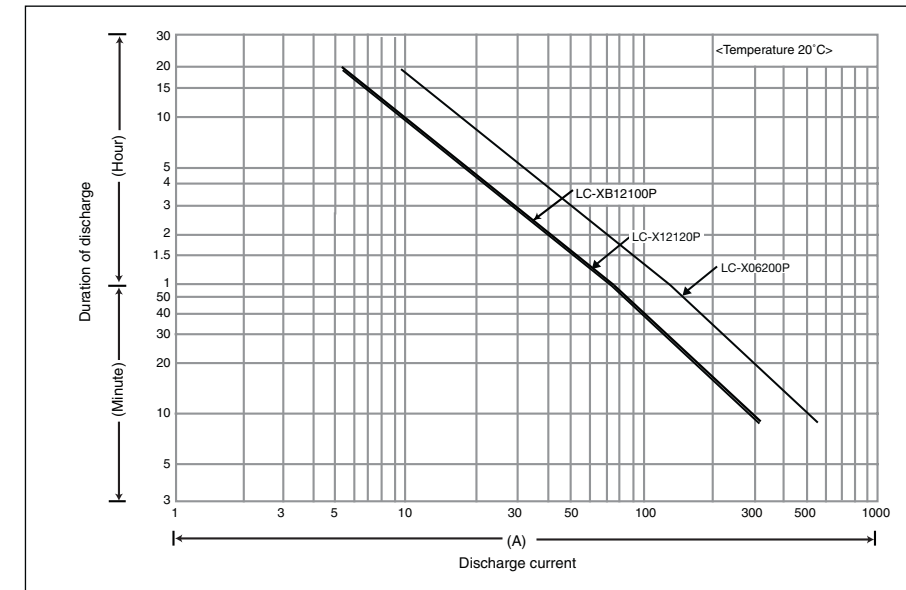

**VRLA battery for standby power applications (100Ah)**

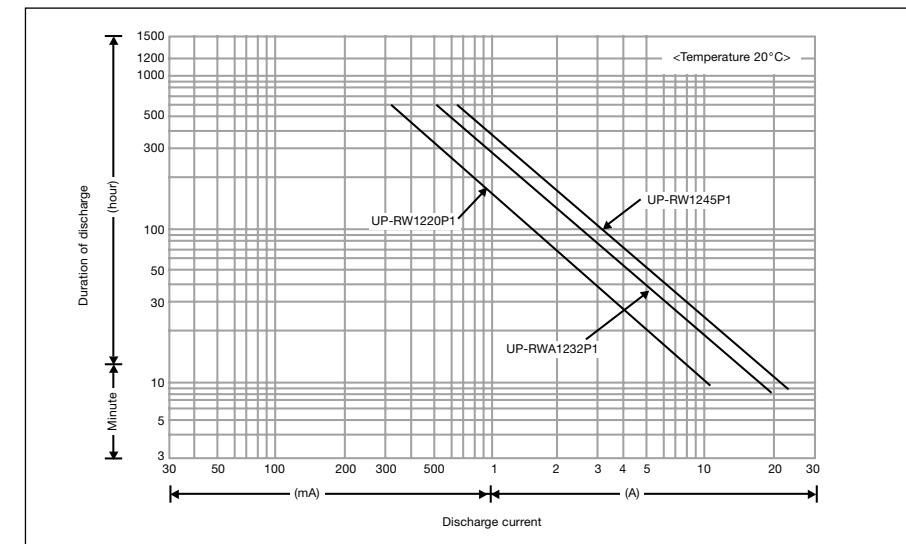

**VRLA battery for standby power applications (high-power for UPS)**

## 10 | Battery Selection Guide

Steps for selecting batteries are described below.

### Study of required specifications (draft)

Study the required specifications (draft) by checking the requirements for the battery with the battery selection criteria. Technical requirements for selecting the battery are presented below.

### Battery selection

First, select several candidate batteries by referring to the technical brochures and data sheets of the batteries presently available. Then from the candidates select a battery which can meet as many of the ideal requirements as possible. In fact, however, battery selection can be seldom made so smoothly. Practically, possible removal or easing of the requirements should be considered first; then depending on the result, a proper battery should be selected from those presently available. This way of proceeding

enables economic selection of the battery. Any questions at this stage should be asked to battery engineers in depth. Sometimes, new or improved batteries which are not carried in the brochures have become available, and an appropriate battery may be found among them. Usually, required specifications are finalized at this stage.

### Request for improving or developing batteries

If no battery which will satisfy special requirements can be found by the above-described approach, requests for improving or developing new batteries should be made to our technical department, and these requests should be coordinated as quickly as possible to allow enough time for studying: the study takes usually 6 to 12 months or even longer depending on the request. In this section, guidelines for selecting appropriate batteries for specific equipment were mentioned. If further information regarding the battery selection is required, please contact us.

### Technical requirements for battery selection

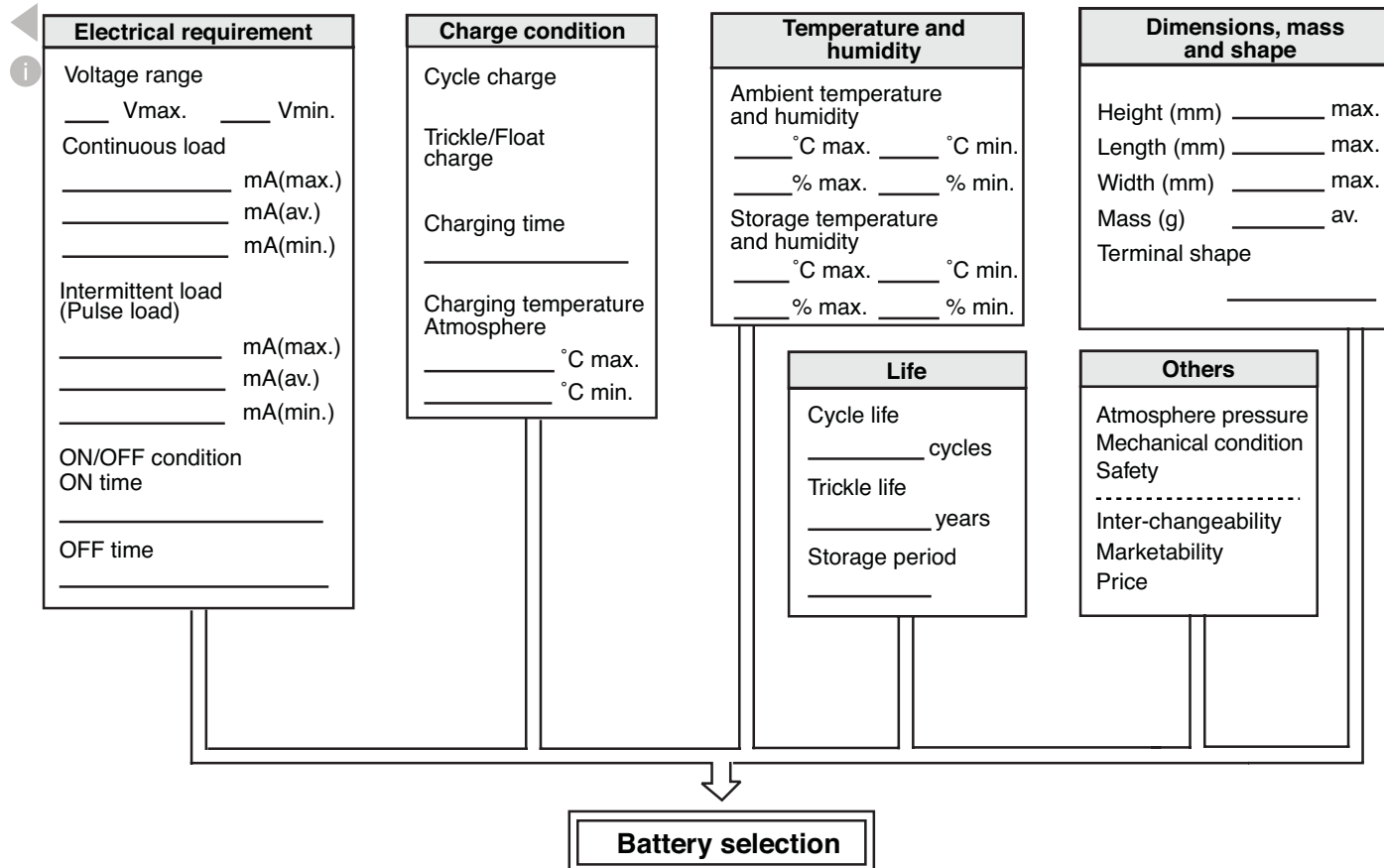

## 11 | Battery Index

### Battery Types and Model Numbers

Application	Series	Trickle Design Life (at 20°C)	Category	Standard ABS (UL94 HB)	FR ABS = Flame Retardant ABS (UL94 V-0)
Back Up	LC-V	6 – 9 years	Trickle standard type		●
	LC-X	10 – 12 years	Trickle long life type	●	
	LC-P	10 – 12 years	Trickle long life type		●
	LC-QA	15 years	Trickle super long life type		●
	UP-RW	6 – 9 years	High power standard type	●	
UP-PW	10 – 12 years	High power long life type		●	
Back Up and Main Power	LC-R	6 – 9 years	Trickle and cycle standard type	●	
Main Power	LC-CA	-	Cycle long life type	●	
	LC-XC	-	Cycle long life type	●	

### LC Series – Trickle Design Life 6 – 9 Years

Model Number	Nominal Voltage (V)	Rated Capacity (Ah) 20 hour rate	Dimensions (mm)				Mass approx. (kg)	Page	VdS VdS N°
			Length	Width	Height	Approx. Total Height			
LC-R061R3P*1	6	1.3	97	24	50	55	0.3	36	-
LC-R063R4P*1	6	3.4	134	34	60	66	0.6	38	-
LC-R064R5P*1	6	4.5	70	48	102	108	0.7	40	-
LC-R067R2P*1	6	7.2	151	34	94	100	1.3	42	-
LC-R0612P*1	6	12	151	50	94	100	2.0	44	-
LC-R0615P	6	15	151	50	94	100	2.1	46	-
LC-R121R3PG	12	1.3	97	47.5	50	55	0.6	48	G196049
LC-R122R2PG	12	2.2	177	34	60	66	0.8	50	G188151
LC-R123R4PG	12	3.4	134	67	60	66	1.2	52	G191053
LC-R124R5P	12	4.5	70	97	102	108	1.5	54	-
LC-R127R2PG*2	12	7.2	151	64.5	94	100	2.5	56	G193046
LC-RA1212PG	12	12	151	98	94	100	3.8	58	G100001
LC-RA1215P	12	15	151	98	94	100	4.2	60	-
LC-R1233P	12	33	195.6	130	155	180	12.0	62	-
LC-V1233P	12	33	195.6	130	155	180	11.1	64	-

### LC Series – Trickle Design Life 10 – 12 Years

Model Number	Nominal Voltage (V)	Rated Capacity (Ah) 20 hour rate	Dimensions (mm)				Mass approx. (kg)	Page	VdS VdS N°
			Length	Width	Height	Approx. Total Height			
LC-P067R2P	6	7.2	151	34	94	100	1.30	66	-
LC-P0612P	6	12	151	50	94	100	2.00	68	-
LC-X06200P*1	6	200	407	173	210	250	41.00	70	-
LC-P122R2P	12	2.2	177	34	60	66	0.80	72	-
LC-P123R4P	12	3.4	134	67	60	66	1.20	74	-
LC-P127R2P	12	7.2	151	64.5	94	100	2.50	76	-
LC-PA1212P	12	12	151	98	94	100	3.80	78	-
LC-XD1217PG/APG	12	17	181	76	167	167	6.50	80	G104101

\*1 This battery is also available with a flame retardant battery case resin (UL94 V-0).  
\*2 LC-R127R2P is available with flame retardant case resin (UL94 V-0) but with no VdS certification.



11 | Battery Index

LC Series – Trickle Design Life 10 – 12 Years

Model Number	Nominal Voltage (V)	Rated Capacity (Ah)	Dimensions (mm)				Mass approx. (kg)	Page	VdS VdS N°
		20 hour rate	Length	Width	Height	Approx. Total Height			
LC-X1220P/AP*1	12	20	181	76	167	167	6.6	82	-
LC-X1224PG/APG	12	24	165	125	175	179.5/175	9.0	84	G198049
LC-X1228P/AP*1	12	28	165	125	175	179.5/175	11.0	86	-
LC-X1238PG/APG	12	38	197	165	175	180/175	13.0	88	G100002
LC-X1242P/AP*1	12	42	197	165	175	180/175	16.0	90	-
LC-X1265PG	12	65	350	166	175	175	20.0	92	G199090
LC-X1275P*1	12	75	350	166	175	175	24.0	94	-
LC-XB12100P*1	12	100	407	173	210	236	37.0	96	-
LC-X12120P*1	12	120	407	173	210	236	37.0	98	-

LC Series – Cycle Long Life

Model Number	Nominal Voltage (V)	Rated Capacity (Ah)	Dimensions (mm)				Mass approx. (kg)	Page	VdS VdS N°
		20 hour rate	Length	Width	Height	Approx. Total Height			
LC-CA1212P	12	12	151	98	94	100	3.8	100	-
LC-CA1215P	12	15	151	98	94	100	4.2	102	-
LC-CA1216P	12	16	151	98	99	105	4.7	104	-
LC-XC1222P	12	22	181	76	167	167	6.6	106	-
LC-XC1228P	12	28	165	125	175	179.5	10.0	108	-
LC-XC1238P	12	38	197	165	175	179.5	15.0	110	-

UP-RW / PW Series – Trickle Design 6 – 9 and 10 – 12 Years

Model Number	Nominal Voltage (V)	Rated Power (W)	Dimensions (mm)				Mass approx. (kg)	Page	VdS VdS N°
		10 minute rate	Length	Width	Height	Approx. Total Height			
UP-RW0645P*1,2	6	135	151	34	94	100	1.3	112	-
UP-RW1220P*1,2	12	120	140	38.5	94	100	1.4	114	-
UP-RW1228P*1,2	12	200	151	64.5	94	100	1.9	116	-
UP-RWA1232P1/P2*1,2	12	192	151	51	94	100	2.0	118	-
UP-RW1236P*1,2	12	224	151	64.5	94	100	2.1	120	-
UP-RW1245P*1,2	12	270	151	64.5	94	100	2.6	122	-
UP-PW1245P*3	12	270	151	64.5	94	100	2.6	124	-

LC-QA Series – Trickle Design Life 15 Years

Model Number	Nominal Voltage (V)	Rated Capacity (Ah)	Dimensions (mm)				Mass approx. (kg)	Page	VdS VdS N°
			Length	Width	Height	Approx. Total Height			
LC-QA06210TP	6	210	407	173	210	250	36.5	126	-
LC-QA1224AP	12	24	165	125	175	175	10.0	128	-
LC-QA1242P/AP	12	42	197	165	175	180	16.0	130	-
LC-QA1270P	12	70	350	166	175	175	23.5	132	-
LC-QA12110TP	12	110	407	173	210	236	36.0	134	-

\*1 This battery is also available with a flame retardant battery case resin (UL94 V-0). \*2 Trickle Design Life 6 – 9 Years. \*3 Trickle Design Life 10 – 12 Years.

12 | Standards

Product Standards

Alarm security market / VdS approved batteries

Model Number	Nominal Voltage (V)	Rated Capacity (Ah)	VdS VdS N°	Country of origin
LC-R121R3PG	12	1,3	G196049	China
LC-R122R2PG	12	2,2	G188151	China
LC-R123R4PG	12	3,4	G191053	China
LC-R127R2PG	12	7,2	G193046	China
LC-RA1212PG	12	12	G100001	China
LC-XD1217PG/APG	12	17	G104101	China
LC-X1224PG/APG	12	24	G198049	China
LC-X1238PG/APG	12	38	G100002	China
LC-X1265PG	12	65	G199090	China

UL Standard

All our VRLA batteries are in compliance with UL 1989 (Standby Batteries) – file number MH 13723. UL 1989 requires that the battery is free from the hazard of bursting, that is, when the battery is overcharged the vent valve opens to release internal pressure.

JIS (Japan Industrial Standard)

All our VRLA batteries are in compliance with JIS C 8702 (almost harmonized with IEC 61056).

Factory Standards

ISO 9001 / ISO 14001

Quality Management System (ISO 9001) defines what the organization does to ensure that its products or services satisfy the customer's quality requirements and comply with any regulations applicable to those products or services. ISO 14000 is primarily concerned with "environmental management". In plain language, this means what the organization does to minimize harmful effects on the environment caused by its activities.

OHSAS 18001

OHSAS 18001 is an Occupation Health and Safety Assessment Series for health and safety management systems. It is intended to help organizations to control occupational health and safety risks. It was developed in response to widespread demand for a recognized standard against which to be certified and assessed.

Other applicable Standards

Following documents are established by consensus and approved by a recognized body, that provides, for common and repeated use, rules, guidelines or characteristics for activities or their results, aimed at the achievement of the optimum degree of order in a given context.

**NOTE:** Standards should be based on the consolidated results of science, technology and experience, and aimed at the promotion of optimum community benefits.

IEC standards cover a vast range of technologies from power generation, transmission and distribution to home appliances and office equipment, semiconductors, fibre optics, batteries, solar energy, nanotechnology and marine energy as well as many others.

IEC standards are also being adopted as harmonized standards by other certifying bodies such as BSI (Great Britain), CSA (Canada), UL & ANSI/INCITS (USA), SABS (South Africa), SAI (Australia), SPC/GB (China), DIN (Germany) and JIS (Japan). IEC standards harmonized by other certifying bodies generally have some noted differences from the original IEC standard.

## 12 | Standards

### **IEC 61056**

Specifies the general requirements, functional characteristics and methods of test for all general purpose lead acid cells and batteries of the valve regulated type for either cyclic or float charge application; in portable equipment, for instance, incorporated in tools, toys, or in static emergency, or uninterruptible power supply and general power supplies.

The cells of this kind of lead-acid battery may either have flat-plate electrodes in prismatic containers or have spirally wound pairs of electrodes in cylindrical containers. The sulfuric acid in these cells is immobilized between the electrodes either by absorption in a microporous structure or in a gelled form.

#### **IEC 61056-1**

General purpose lead acid batteries (valve-regulated types)  
Part 1: General requirements, functional characteristics-  
Method of test

#### **IEC 61056-2**

General purpose lead acid batteries (valve-regulated types)  
Part 2: Dimensions, terminals and marking

#### **IEC 60896-21**

Stationary lead-acid batteries. Valve regulated types.  
Methods of test.

This part of IEC 60896 applies to all stationary lead-acid cell and monobloc batteries of the valve regulated type for float charge applications, (i.e. permanently connected to a load and to a d.c. power supply), in a static location, (i.e. not generally intended to be moved from place to place) and incorporated into stationary equipment or installed in battery rooms for use in telecom uninterruptible power supply (UPS), utility switching, emergency power or similar applications.

Following standards are adopted as harmonized standards.

#### **EN 50272-2 [DIN VDE 0510 Part 2]**

Safety Requirements for Secondary Batteries and Battery Installations. Safety requirements for batteries and battery systems-stationary batteries. The ventilation requirements for safety rooms are specified herein. Apply the VRLA formula together with our batteries.

#### **GOST-R (GOSSTANDART of RUSSIA)**

Certifies quality of actually supplied goods and their compliance with contractual terms. A quality certificate contains a profile of goods or confirms their compliance with certain standards or specifications of a delivery order. A certificate of compliance is intended for certification of goods produced by Russian companies or shipped to Russia by an importer-company.