

TERMSERIES
TRS 60VUC 1CO EMPTY

Weidmüller Interface GmbH & Co. KG
Klingenbergstraße 16
D-32758 Detmold
Germany
Fon: +49 5231 14-0
Fax: +49 5231 14-292083
www.weidmueller.com

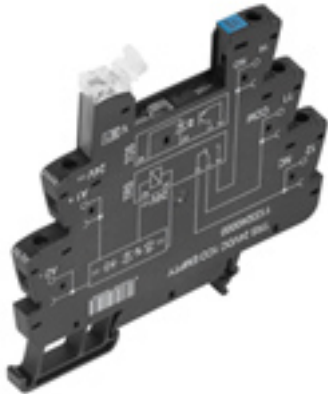

TERMSERIES accessories include:

- Spare relay
- Base
- Partition plates
- Cross-connections
- Power-feed modules

General ordering data

Type	TRS 60VUC 1CO EMPTY
Order No.	1123280000
Version	TERMSERIES, Relay base, Rated control voltage: 60 V UC ±10 %, Continuous current: 10 A, Screw connection
GTIN (EAN)	4032248905270
Qty.	10 pc(s).

TERMSERIES TRS 60VUC 1CO EMPTY

Weidmüller Interface GmbH & Co. KG
 Klingenbergstraße 16
 D-32758 Detmold
 Germany
 Fon: +49 5231 14-0
 Fax: +49 5231 14-292083
 www.weidmueller.com

Technische Daten

Dimensions and weights

Width	6.4 mm	Height	90 mm
Depth	88 mm	Net weight	34 g

Temperatures

Operating temperature	-40 °C...+60 °C	Storage temperature	-40 °C...+85 °C
-----------------------	-----------------	---------------------	-----------------

Input

Coil resistance	Protective circuit	Rectifier
Pull-inrop-out current, typ.	Rated control voltage	60 V UC ±10 %
Pull-inrop-out typ.	Status indicator	Green LED

Output

Rated switching voltage	250 V AC	Continuous current	10 A
-------------------------	----------	--------------------	------

General data

Wire connection method	Screw connection	UL 94 flammability rating	V-0
Wire cross-section, solid, max.	2.5 mm ²		

Insulation coordination

Protection degree	IP 20
-------------------	-------

Other technical data

Protective circuit	Rectifier	Status indicator	Green LED
--------------------	-----------	------------------	-----------

Further details of approvals / standards

Standards	DIN EN 50178
-----------	--------------

Connection data

Clamping range, rated connection	1.5 mm ²	Clamping range, rated connection, max.	1.5 mm ²
Clamping range, rated connection, min.	0.14 mm ²	Conductor cross-section, flexible, AEH (DIN 46228-1), max.	1.5 mm ²
Conductor cross-section, flexible, AEH (DIN 46228-1), min.	0.25 mm ²	Stripping length, rated connection	8 mm
Tightening torque, max.	0.4 Nm	Wire connection cross section AWG, max.	AWG 14
Wire connection cross section AWG, min.	AWG 26	Wire connection cross section, finely stranded, max.	1.5 mm ²
Wire connection cross section, finely stranded, two clampable wires, min.	0.5 mm ²	Wire connection method	Screw connection
Wire cross-section, finely stranded, max. (AWG)	AWG 14	Wire cross-section, finely stranded, min. (AWG)	AWG 26
Wire cross-section, finely stranded, two clampable wires, max.	1 mm ²	Wire cross-section, solid, max.	2.5 mm ²
Wire cross-section, solid, min.	0.14 mm ²		

Datenblatt**TERMSERIES
TRS 60VUC 1CO EMPTY****Weidmüller Interface GmbH & Co. KG**
Klingenbergstraße 16
D-32758 Detmold
Germany
Fon: +49 5231 14-0
Fax: +49 5231 14-292083
www.weidmueller.com**Technische Daten****Classifications**

eClass 6.2	27-37-16-01	eClass 7.1	27-37-16-01
------------	-------------	------------	-------------

Approvals

Approvals

**Downloads**

Declaration of Conformity	K438_10_12.pdf
PDF	Operating Instructions
	3D Modell

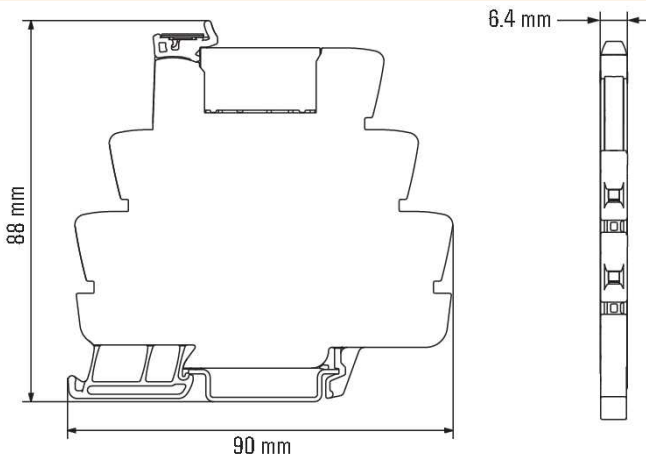
Datenblatt**TERMSERIES
TRS 60VUC 1CO EMPTY****Weidmüller Interface GmbH & Co. KG**
Klingenbergstraße 16
D-32758 Detmold
Germany
Fon: +49 5231 14-0
Fax: +49 5231 14-292083
www.weidmueller.com**Zeichnungen**

Datenblatt

**TERMSERIES
TRS 60VUC 1CO EMPTY**

Weidmüller Interface GmbH & Co. KG
 Klingenbergstraße 16
 D-32758 Detmold
 Germany
 Fon: +49 5231 14-0
 Fax: +49 5231 14-292083
 www.weidmueller.com

Zeichnungen

