

# R8 Recorder: Sampler Interface: Controller

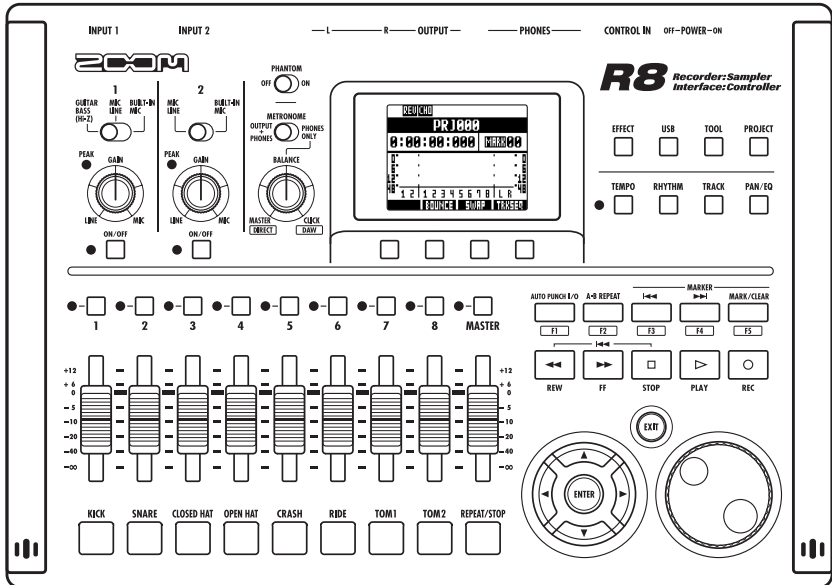

## OPERATION MANUAL

# ZOOM



© ZOOM Corporation

Reproduction of this manual, in whole or in part, by any means, is prohibited.



# Usage and safety precautions

## SAFETY PRECAUTIONS

In this manual, symbols are used to highlight warnings and cautions that you must read to prevent accidents. The meanings of these symbols are as follows:



	Warning Something that could cause serious injury or death.
	Caution Something that could cause injury or damage to the equipment.

Other symbols



	Required (mandatory) actions
	Prohibited actions

### Warning

#### Operation using an AC adapter

-  Use only a ZOOM AD-17 AC adapter with this unit.
-  Do not use in ways that exceed the ratings of an outlet or wiring or with currents other than 100 V. Before using this product in other countries (or regions) where the power voltage differs from AC 100 V, always consult with a store that handles ZOOM products and use a suitable AC adapter.

#### Operation using batteries



-  Use 4 conventional 1.5-volt AA batteries (alkaline or nickel-metal hydride).
-  Read battery warning labels carefully.
-  Always close the battery compartment cover when using the unit.

#### Alterations





-  Never open the case or attempt to modify the product.

### Precautions



#### Product handling

-  Do not drop, bump or apply excessive force to the unit.
-  Be careful not to allow foreign objects or liquids to enter the unit.



#### Operating environment

-  Do not use in extremely high or low temperatures.
-  Do not use near heaters, stoves and other heat sources.
-  Do not use in very high humidity or near splashing water.
-  Do not use in places with excessive vibrations.
-  Do not use in places with excessive dust or sand.



#### AC adapter handling

-  When disconnecting the AC adapter from an outlet, always pull the body of the adapter itself.
-  During lightning storms or when not using the unit for a long time, disconnect the power plug from the AC outlet.

#### Battery handling

-  Install the batteries with the correct +/- orientation.
-  Use a specified battery type. Do not mix new and old batteries or different brands or types at the same time.
-  When not using the unit for an extended period of time, remove the batteries from the unit. If a battery leak should occur, wipe the battery compartment and the battery terminals carefully to remove all battery residue.

#### Connecting cables with input and output jacks

-  Always turn the power OFF for all equipment before connecting any cables.
-  Always disconnect all connection cables and the AC adapter before moving the unit.

#### Volume

-  Do not use the product at a loud volume for a long time.

## Usage Precautions

#### Interference with other electrical equipment

In consideration of safety, the **RB** has been designed to minimize the emission of electromagnetic radiation from the device and to minimize external electromagnetic interference. However, equipment that is very susceptible to interference or that emits powerful electromagnetic waves could result in interference if placed nearby. If this occurs, place the **RB** and the other device farther apart.

With any type of electronic device that uses digital control, including the **RB**, electromagnetic interference could cause malfunction, corrupt or destroy data and result in other unexpected trouble. Always use caution.

#### Cleaning

Use a soft cloth to clean the panels of the unit if they become dirty. If necessary, use a damp cloth that has been wrung out well.

Never use abrasive cleansers, wax or solvents, including alcohol, benzene and paint thinner.

#### Malfunction

If the unit becomes broken or malfunctions, immediately disconnect the AC adapter, turn the power OFF and disconnect other cables. Contact the store where you bought the unit or Zoom service with the following information: product model, serial number and specific symptoms of failure or malfunction, along with your name, address and telephone number.

#### Copyrights

Except for personal use, unauthorized recording of copyrighted sources, including CDs, records, tapes, video products and broadcasts, is prohibited. Zoom Corporation does not bear any responsibility for consequences related to copyright law infringement.

- The SD  and  SDHC symbols are trademarks.
- Windows® and Windows Vista® are trademarks or registered trademarks of Microsoft®.
- Macintosh® and Mac OS® are trademarks or registered trademarks of Apple Inc.
- Steinberg and Cubase are trademarks or registered trademarks of Steinberg Media Technologies GmbH Inc.
- All other trademarks, product names and company names mentioned in this documentation are the property of their respective owners.
- All trademarks and registered trademarks mentioned in this manual are for identification purposes only and are not intended to infringe on the copyrights of their respective owners.

# Introduction

Please read through this manual carefully in order to understand the functions of the **RB** well so that you can use it happily for many years.  
After reading through this manual, please keep it along with the warranty in a safe place.  
Please note that some details might be changed without notice in order to improve the product.

Thank you very much for purchasing the ZOOM **RB**, which we will refer to as the **RB** in this manual. The **RB** has the following features.

## ■ Multitrack recorder that can use up to 32 GB SDHC cards

The **RB** can be an 8-track recorder that supports SDHC cards of up to 32 GB. After making linear PCM recordings (WAV format) at 16/24-bit and 44.1/48kHz sampling rate, you can transfer recorded files to your computer to use them in DAW software.

## ■ Hi-Speed USB 2.0 audio interface

You can use the **RB** and its various input and output jacks as a Hi-speed USB 2.0 audio interface that can handle 2 inputs and 2 outputs at up to 24-bit and 96 kHz. Its effects can even be used (at 44.1 kHz only) and it can also operate using USB bus power.

(See the Audio Interface Manual on the included SD card for details.)

## ■ DAW software control surface

The **RB** can be connected to a computer by USB cable and used as a control surface for DAW software. You can operate transport functions, including play, record and stop keys and physically control onscreen faders. You can also assign various DAW functions to the F1–F5 function keys. (The assignable functions depend on the DAW software.)

(See the Audio Interface Manual on the included SD card for details.)

## ■ Handles a variety of input sources including guitars, microphones and line-level equipment

The **RB** has 2 input jacks that accept both XLR and standard phone connectors. Both can supply phantom power (24 or 48 V) and one can handle high-impedance input. In addition to high-impedance guitars and basses, the inputs can handle all types of sources, including dynamic and condenser microphones, synthesizers and other line level instruments. The built-in high-performance microphones are convenient for recording acoustic guitars and vocals.

(See "Connecting instruments" on P.21.)

## ■ Sampler with 8 pads and 8 voices

Use the sampler to assign sounds to each track (pad) and create loops. Play the pads in real-time, and combine loops to create performances for a complete song. By simply lining up drum loops from the included SD card, anyone can easily create professional-quality backing parts and basic tracks. The recorder and sampler work together seamlessly, so you can record audio on other tracks while listening to loop playback.

(See "Using the sampler to make songs" on P.60.)

### Confirmation of included items

The package contains the following items. Please verify them.

**RB unit**

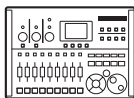

**SD card**



**USB cable**



**AC adapter  
(ZOOM AD-17)**



**Cubase LE Download  
access code sheet**



**Operation manual  
(this document)**



**Cubase LE  
Startup Guide**



Note: the Audio Interface Manual (PDF) is on the SD card.

# Contents

<b>Usage and safety precautions</b> . . . . .	2
<b>Introduction</b> . . . . .	3
Confirmation of included items . . . . .	3
<b>Contents</b> . . . . .	4
<b>Panel layout and functions</b> . . . . .	6
<b>Switch and key overview</b> . . . . .	8
<b>Display information</b> . . . . .	9
<b>Operation overview</b> . . . . .	10
<b>Connections</b> . . . . .	12
<b>SD card installation</b> . . . . .	13
<b>Powering the unit</b> . . . . .	14
<b>Turning the power on and off</b> . . . . .	15
<b>Setting the date and time</b> . . . . .	15
<b>Recording and playback</b> . . . . .	16
Recorder overview . . . . .	16
Preparations before recording . . . . .	17
Creating a new project . . . . .	17
Changing the time signature . . . . .	18
Setting the tempo . . . . .	19
Using the metronome . . . . .	20
Recording the first track . . . . .	21
Connecting instruments . . . . .	21
Adjusting the input gain . . . . .	22
Using insert effects . . . . .	23
Adjusting the recording level . . . . .	24
Selecting tracks for recording . . . . .	25
Recording . . . . .	26
Re-recording . . . . .	26
Recording to a new file . . . . .	27
Playing back recordings . . . . .	27
Overdubbing . . . . .	28
Stereo recording (stereo link) . . . . .	29
Changing playback takes . . . . .	30
Swapping two tracks . . . . .	31
Re-recording part of a track (punch-in/out) . . . . .	31
Manual punch-in/out . . . . .	32
Automatic punch-in/out . . . . .	33
Combining multiple tracks into 1–2 tracks (bouncing) . . . . .	34
Locating to the desired part of a song . . . . .	36
Repeat playback of a specific section (A-B repeat) . . . . .	38
<b>Mixing</b> . . . . .	40
Mixing overview . . . . .	40
Setting track level, EQ and pan . . . . .	42
Using send-return effects . . . . .	44
Using insert effects on tracks . . . . .	45
<b>Mixing down</b> . . . . .	46
Using a mastering effect . . . . .	46
Mixing down to the master track . . . . .	47
<b>Using the rhythm function</b> . . . . .	48
Overview of rhythm functions . . . . .	48
Rhythm pattern selection . . . . .	49
Changing the playback pattern . . . . .	49
Changing the drum kit . . . . .	49
Using the pads to play rhythm patterns . . . . .	50
Switching banks . . . . .	50
Repeating sounds (drum rolls) . . . . .	50
Adjusting the pad sensitivity . . . . .	49
Assigning rhythm patterns to tracks . . . . .	51
Creating a rhythm pattern . . . . .	52
Preparing to create a rhythm pattern . . . . .	52
Inputting a pattern in real-time . . . . .	53
Step input of a rhythm pattern . . . . .	54
Copying rhythm patterns . . . . .	55
Deleting rhythm patterns . . . . .	56
Renaming rhythm patterns . . . . .	57
Importing rhythm patterns from other projects . . . . .	58
Setting volume and stereo placement . . . . .	59

<b>Using the sampler</b> . . . . .	60	<b>Working with projects and audio files</b> . . . . .	90
Using the sampler to make songs . . . . .	60	Projects and audio files . . . . .	90
Using the sampler . . . . .	61	Protecting a project . . . . .	91
Assigning included drum loops to tracks . . . . .	63	Selecting a project . . . . .	91
Setting loops . . . . .	64	Viewing project and audio file information . . . . .	92
Setting a track to loop . . . . .	64	Copying projects and audio files . . . . .	93
Setting the loop interval . . . . .	65	Changing project and audio file names . . . . .	94
Playing the pads . . . . .	66	Deleting projects and audio files . . . . .	95
Setting the playback method . . . . .	66	Dividing audio files . . . . .	96
Set global quantization to . . . . .	66	Setting the recording format (bit length) . . . . .	97
control sound timing . . . . .	66	Setting the recording mode . . . . .	97
Changing the BPM of a track . . . . .	67	Sequential playback of projects . . . . .	98
Changing audio tempo without . . . . .	68	Loading audio files from other projects . . . . .	100
changing pitch . . . . .	68	<b>Using the USB connection</b> . . . . .	102
Trimming unnecessary parts of audio files . . . . .	70	USB function overview . . . . .	102
Setting fade-ins and fade-outs . . . . .	71	Exchanging data with a computer . . . . .	103
<b>Using the track sequencer</b> . . . . .	72	(card reader) . . . . .	103
Track sequencer overview . . . . .	72	Audio interface and . . . . .	105
Creating a sequence . . . . .	73	control surface functions . . . . .	105
Creating a sequence in real-time . . . . .	73	<b>Other functions</b> . . . . .	108
Creating a sequence using step input . . . . .	74	Using the tuner . . . . .	108
Inserting and deleting beats . . . . .	76	Adjusting the display . . . . .	109
Playing back a sequence . . . . .	78	Changing the SD card while . . . . .	110
<b>Using effects</b> . . . . .	80	the power is on . . . . .	110
Overview of effects . . . . .	80	Formatting an SD card . . . . .	111
Selecting effect patches . . . . .	83	Checking remaining card capacity . . . . .	111
Editing patches . . . . .	84	Setting the battery type . . . . .	112
Saving patches . . . . .	86	Setting phantom power voltage . . . . .	112
Importing patches from other projects . . . . .	87	Using a footswitch . . . . .	113
Changing patch names . . . . .	88	Checking the firmware version . . . . .	114
Using effects only for monitoring . . . . .	89	Upgrading the firmware . . . . .	114
		<b>Rhythm pattern list</b> . . . . .	116
		<b>Effect types and parameters</b> . . . . .	118
		<b>Effect patch list</b> . . . . .	129
		<b>Error message list</b> . . . . .	135
		<b>Troubleshooting</b> . . . . .	136
		<b>Specifications</b> . . . . .	137
		<b>Index</b> . . . . .	138

# Panel layout and functions

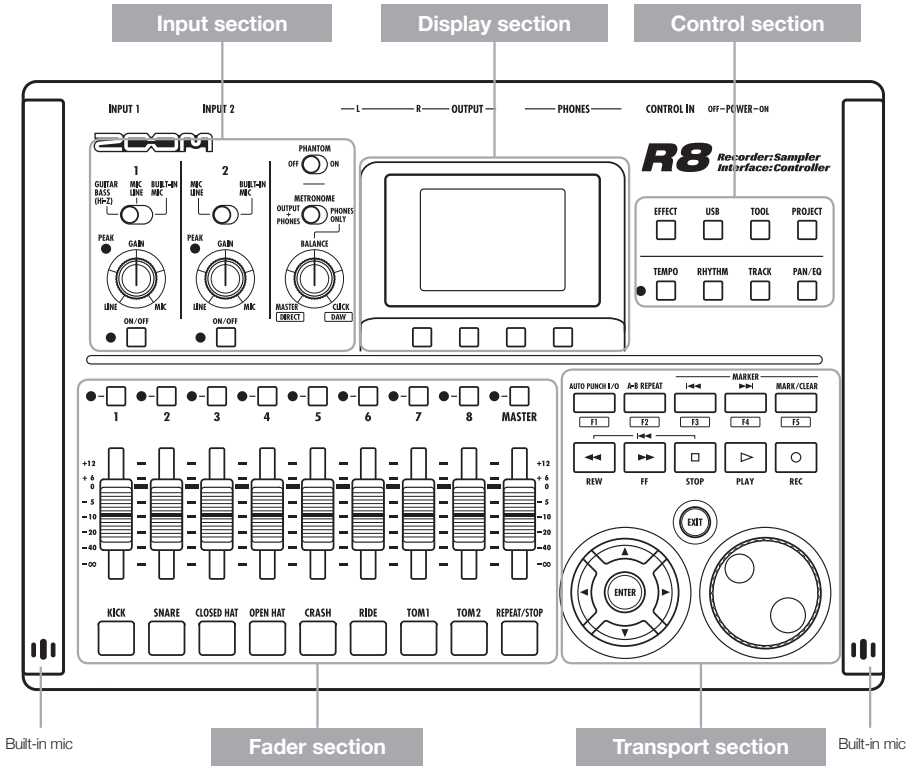

## Rear panel

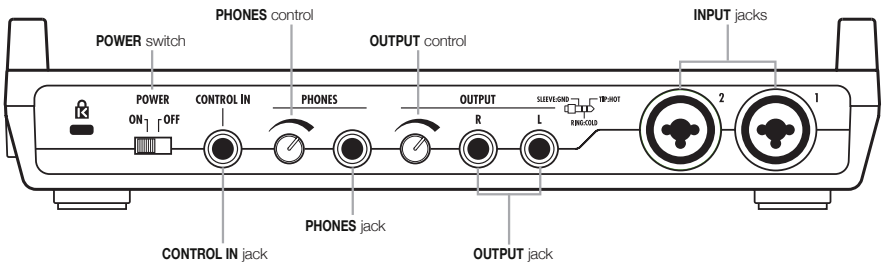

## Right side panel

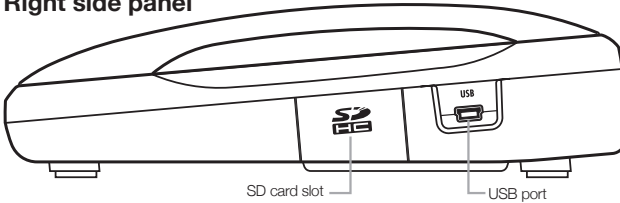

## Bottom panel (not shown)

Battery compartment

### Input section

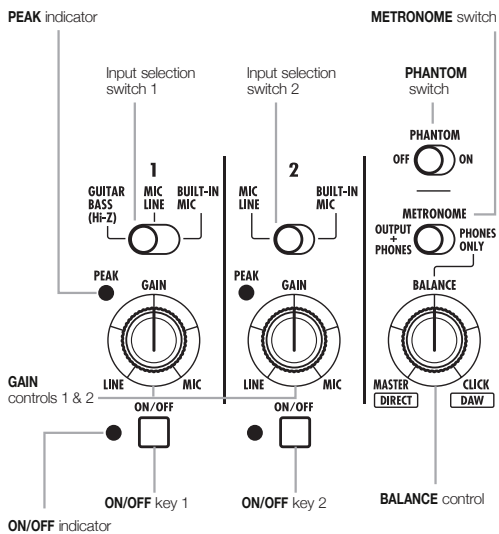

### Display section

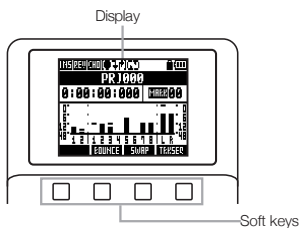

### Control section

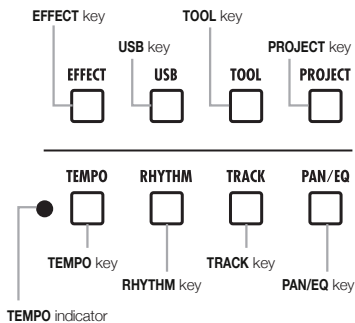

### Fader section

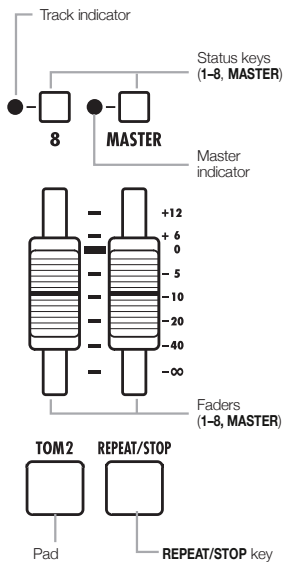



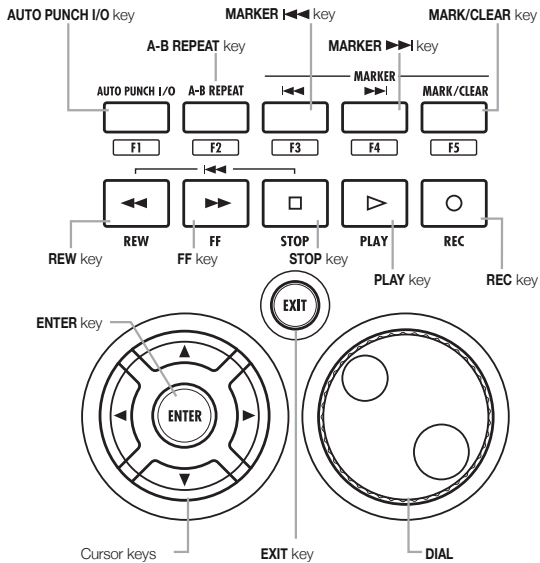



### Transport section







# Switch and key overview

Here we explain how to use the keys and switches of the **RB**.

## Transport section

 <b>REC</b> key	<p>Functions only when tracks are in recording standby.</p> <ul style="list-style-type: none"> <li>Stopped: starts recording standby</li> <li>Recording standby: ends standby</li> <li>Playing: starts recording (manual punch-in/out)</li> </ul>
 <b>PLAY</b> key	<ul style="list-style-type: none"> <li>Stopped: starts playback</li> <li>Recording standby: starts recording</li> </ul>
 <b>STOP</b> key	<ul style="list-style-type: none"> <li>During recording: stops recording</li> <li>During playback: stops playback</li> <li>Recording standby: stops transport</li> </ul>
 <b>FF</b> key	<ul style="list-style-type: none"> <li>When stopped or during playback: fast forwards</li> </ul>
 <b>REW</b> key	<ul style="list-style-type: none"> <li>When stopped or during playback: rewinds</li> <li>Hold <b>STOP</b> and press <b>REW</b> to return to the top of the song.</li> </ul> <div style="display: flex; align-items: center; justify-content: center;">  +  </div>

 <b>ENTER</b> key	<ul style="list-style-type: none"> <li>Confirm an item</li> </ul>
 <b>EXIT</b> key	<ul style="list-style-type: none"> <li>Press to go back.</li> <li>Press and hold to return to the top screen.</li> </ul>
 <b>DIAL</b>	<ul style="list-style-type: none"> <li>Change numbers and move among menus.</li> </ul>
	<ul style="list-style-type: none"> <li>Set, remove and move to marks</li> </ul>
	<ul style="list-style-type: none"> <li>Set and cancel auto punch-in/out and A-B repeat</li> </ul>



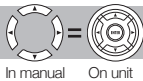





## Cursor appearance





Manual indications	
	In explanations, the usable directions are shown with dark lines.

The cursors are used to move up, down, left and right to choose items. They are shown as above in the manual.







## Control section

 <b>EFFECT</b> key	<ul style="list-style-type: none"> <li>Set the insert and send- return effects</li> </ul>
 <b>USB</b> key	<ul style="list-style-type: none"> <li>Use the audio interface, control surface and card reader</li> </ul>
 <b>TOOL</b> key	<ul style="list-style-type: none"> <li>Make metronome, tuner, system and SD card settings</li> </ul>
 <b>PROJECT</b> key	<ul style="list-style-type: none"> <li>Create, set up and work with projects</li> </ul>
 <b>TEMPO</b> key	<ul style="list-style-type: none"> <li>Set the tempo (the indicator flashes in time with the tempo)</li> </ul>
 <b>RHYTHM</b> key	<ul style="list-style-type: none"> <li>Play, create and set rhythm patterns</li> </ul>
 <b>TRACK</b> key	<ul style="list-style-type: none"> <li>Assign tracks and make settings</li> </ul>
 <b>PAN/EQ</b> key	<ul style="list-style-type: none"> <li>Access track mixer settings</li> </ul>

## Fader section

 <b>TRACK 1-8</b> status keys	<p>Change track status and check with indicator</p> <p>Green: play      Unlit: mute          Red: record</p> <p>Orange: loop track or rhythm pattern track playing back</p>
 <b>MASTER</b> status key	<p>Change master track status and check with indicator</p> <p>Green: play      Unlit: master          Red: mix down</p>

## Input section

 <b>Input selection switch 1</b>	<ul style="list-style-type: none"> <li>Set for the instrument or mic used</li> </ul>
 <b>Input selection switch 2</b>	<ul style="list-style-type: none"> <li>Set for the instrument or mic used</li> </ul>
 <b>PHANTOM</b> switch	<ul style="list-style-type: none"> <li>Phantom power <b>ON/OFF</b></li> </ul>
 <b>METRONOME</b> switch	<ul style="list-style-type: none"> <li>Set metronome output</li> <li>When set to <b>PHONES ONLY</b>, <b>BALANCE</b> control adjusts the performance/metronome balance</li> </ul>
 <b>GAIN</b> controls 1, 2	<ul style="list-style-type: none"> <li>Set input sensitivity</li> <li>Indicator lights when input level begins causing distortion</li> </ul>
 <b>ON/OFF</b> key 1, 2	<ul style="list-style-type: none"> <li>Turn input <b>ON/OFF</b></li> <li>Indicator flashes when recording level begins causing distortion</li> </ul>



# Display information

The display shows, for example, project data, connection and operation status as a recorder or a computer audio-interface, available functions and various menus.

## Display and screen information



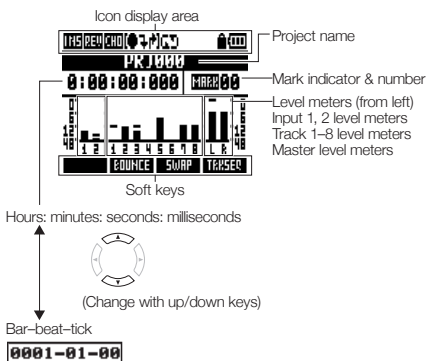

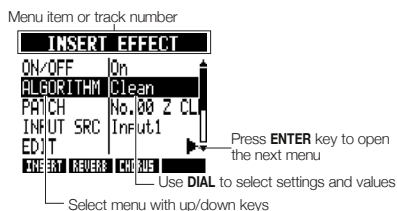

Top Screen: Shows the current project



Menu screen: Shows an operation menu



## Icon display and settings

	<b>Insert effect icon</b> Shown when insert effect enabled.	(P.23, 45, 46, 80) EFFECT To set: <input type="checkbox"/>
	<b>REVERB/CHORUS send-return icons</b> Shown when send-return effects enabled.	(P.44, 80, 82) EFFECT To set: <input type="checkbox"/>
	<b>AUTO PUNCH IN/OUT icons</b> Shown when auto punch-in/out enabled.	(P.33) AUTO PUNCH I/O To set: <input type="checkbox"/>
	<b>A-B REPEAT icon</b> Shown when A-B repeat enabled.	(P.38) A-B REPEAT To set: <input type="checkbox"/>
	<b>PROTECT icon</b> Shown when project protection enabled.	(P.91) PROJECT To set: <input type="checkbox"/>
	<b>Battery icon</b> Shown when using battery power (including remaining charge and when battery needs charged). (Not shown when running on USB.)	(P.14)

## Soft keys



The functions of the soft keys appear at the bottom of the display. Press the key under the indication to use that function.

## 1. Recording preparations

Do the following before starting recording.

### Preparing to record P.17

- To start a new song, make a project first.
  - Creating a new project (P.17)
- Set the song's time signature and tempo.
  - Setting the time signature (P.18)
  - Setting the tempo (P.19)
- Set the metronome to use as a guide when recording.
  - Using the metronome (P.20)

## 2. Recording

Record an instrument, vocal or other sound source to each track. You can also assign audio file loops using the sampler function and rhythm

### Recording the first track P.21

Record instruments and vocals to tracks in the project that you created.

- Connect instruments and mics, and adjust the input sensitivity.
  - Connecting instruments (P.21)
  - Adjusting the input gain (P.22)
  - Recording in stereo (stereo link) (P.29)
- Select tracks to record on and record.
  - Selecting tracks for recording (P.25)
  - Recording (P.26)
- You can use the following types of effects when recording.
  - Using insert effects (P.23)
  - Applying effects only for monitoring (P.89)
- You can also redo part or all of a recording.
  - Undoing the last action (UNDO/REDO) (P.26)
  - Recording part of a song again (punching in/out) (P.32)

### Using the sampler P.60

- Assign audio files to tracks and set loops.
  - Assigning included drum loops to tracks (P.63)
  - Make loop settings (P.64)

### Using rhythm functions P.48

- Assign rhythm patterns to tracks.
  - Assigning rhythm patterns to tracks (P.51)

patterns using the rhythm machine function to tracks, and arrange them in performance order using the track sequencer function.

### Playback P.27

Playback instruments, vocals and other recorded sounds.

- Play back from any position and loop any interval that you want
  - Move to a point in a song (locate) (P.36)
  - Repeat playback of a specific section (A-B repeat) (P.38)
- Change a take (audio file assigned to a track).
  - Changing playback takes (P.30)

### Overdubbing P.28

While playing back the recorded track, you can record (overdub) additional instruments and vocals to other tracks.

### Bouncing tracks P.34

- If you run out of tracks, you can bounce them to reduce the number.
  - Combining multiple tracks into 1-2 tracks (bouncing) (P.34)

### Using sequencer functions P.72

- Arrange loop tracks and rhythm pattern tracks in order to make performance data (sequence data) for one song.
  - Creating sequence data (P.73)
  - Playing back sequence data (P.78)

## 3. Mixing and mix down

After recording and preparing tracks, you can mix them and then make a stereo master track.

### On the *RS*

#### Mixing P.40

Balance the tracks and set the effects used on them (mixing).

- Adjust the balance of the tracks.
  - Setting volume, EQ and pan (P.42)
- You can apply the following types of effects to each track.
  - Applying send-return effects (P.44)
  - Using insert effects on tracks (P.45)

#### Mixing down to stereo P.46

You can rerecord multiple tracks as a final stereo master track (mix down).

- When mixing down, you can apply the following types of effects.
  - Applying mastering effects (P.46)
- Mix down the song to stereo.
  - Mixing down to master tracks (P.47)

### On a computer

By connecting the unit to a computer using a USB cable, you can use it as an audio interface, control surface and card reader. Doing so, you can use DAW software, for example, to mix and master your tracks.

- Audio interface/control surface (P.105)
- Exchanging data with a computer (card reader) (P.103)

Please see the Audio Interface Manual on the included SD card for information about the audio interface.

# Connections

Refer to the illustration below to connect instruments, mics, other audio equipment and a computer, for example.

## Outputs

- 1 Headphones
- 2 Stereo systems, speakers with built-in amplifiers, etc.

## Inputs

Connect cables with XLR or phone plugs (mono/stereo, balanced/unbalanced) to the **INPUT** jacks.

- 3 Microphones
  - Connect a mic to **INPUT 1** or **2**.
  - Set the input selection switch to **MIC LINE**.
  - Set the **PHANTOM** switch to **ON** to supply phantom power to a condenser mic.
- 4 Devices with stereo outputs  
When using a synthesizer, a CD player or other stereo devices:
  - Connect **OUTPUT** jack **L** to **INPUT 1** and **R** to **INPUT 2**.
  - Set both input selection switches to **MIC LINE**.
- 5 Guitar/bass  
To connect a passive electric guitar or bass directly:
  - Connect it to **INPUT 1**.
  - Set input selection switch **1** to **GUITAR BASS (Hi-Z)**.
- 6 Built-in microphones  
Use the built-in mics on the left and right of the unit to record drums or a band performance, for example.
  - Set both input selection switches (**1** for left and **2** for right) to **BUILT-IN MIC**.

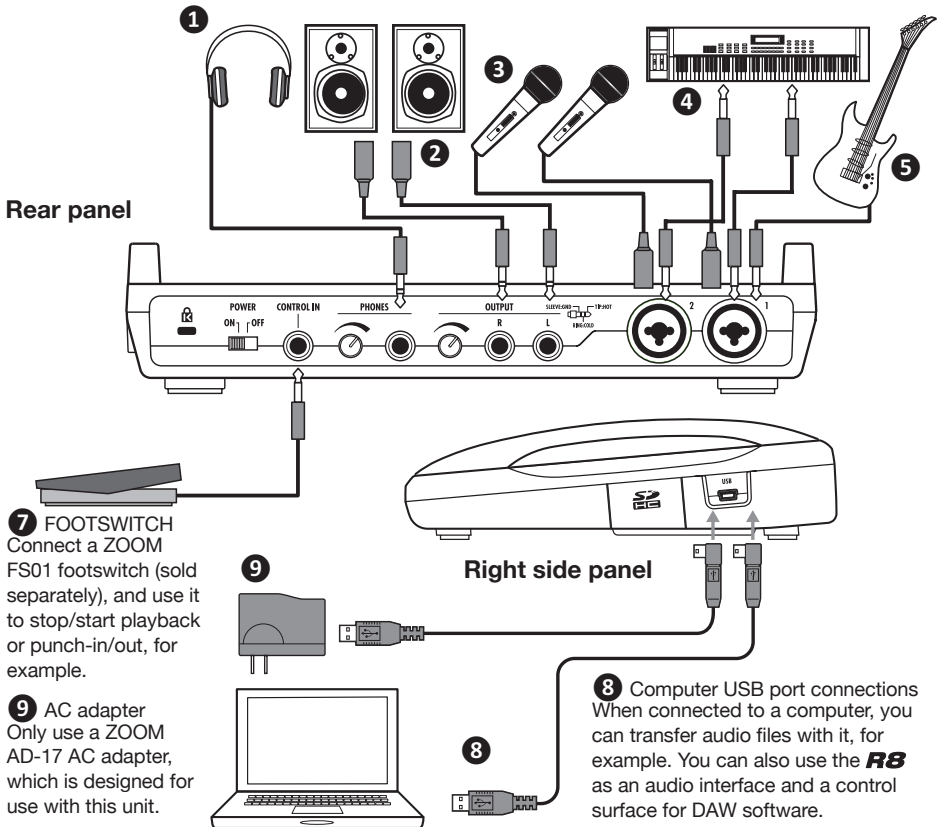

# SD card installation

The **RS** saves recording data and settings on SD cards.

To protect your data, turn the power off before inserting or ejecting a card.

An SD card is necessary for recording.

## Turn the power OFF and insert (ordinary use)

- 1 Turn the **POWER OFF** and remove the SD card slot cover.

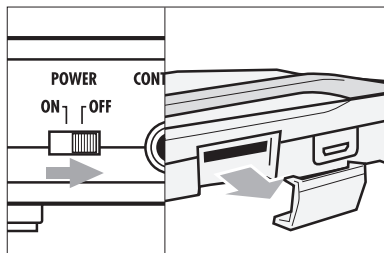

- 2 Insert an SD card that is not write-protected into the slot completely. To eject, push the card in first.

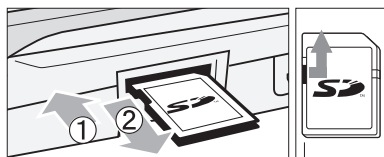

Unlock write-protection

## NOTE

If you want to change the SD card while the power is ON, you must follow special procedures. (P.110)

When inserting or removing an SD card, always turn the power OFF. Doing so when the power is ON could cause recording data to be lost.

If you cannot insert a card into the slot, you might be trying to insert it in the wrong direction or upside down. Do not force the card. Try again with the correct orientation. Forcing the card in could break it.

Always format an SD card that was used with a computer or a digital camera, for example, in the **RS** before using it.

If no SD card is inserted, the **REC** key will not function in Recorder Mode.

## If a message appears

“No Card”: No SD card is detected. Make sure an SD card is inserted properly

“Card Protected”: The SD card is write-protected. Slide the lock switch away from the lock position to disable write-protection.

## HINT

This unit can use 16 MB–2 GB SD cards and 4–32 GB SDHC cards.

You can find the most recent information about compatible SD cards on the ZOOM website. <http://www.zoom.co.jp>

## Preventing SD card theft

Remove the screw near the slot, and screw it into the hole in the SD card cover.

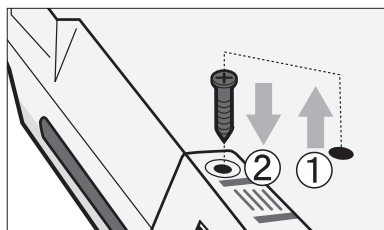

### Reference:

Changing SD cards with the power on

P.110

Formatting SD cards

P.111

# Powering the unit

Use the included AC Adapter or four AA batteries (sold separately) to power the unit.

## Using ordinary power (included AC adapter)

- 1 Turn the power OFF, and then plug the USB cable into the USB port on the right side of the unit.
- 2 Connect the other end of the USB cable to the AC adapter and plug the adapter into a power outlet.

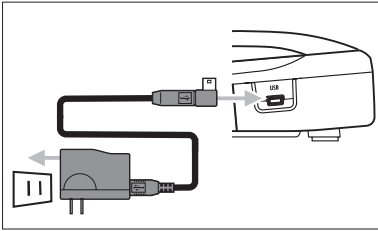

**Caution** Always use the included AC adapter (ZOOM AD-17), which is designed for use with the unit. Using any other adapter could damage the unit.

## HINT

### Power supply from USB

- When used with a computer connected by a USB cable, the computer supplies power to the unit.

## Using batteries

- 1 Turn the power OFF and open the battery case cover on the bottom of the unit.
- 2 Install the batteries and close the cover.

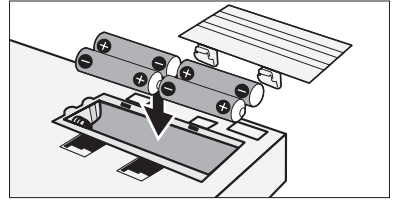

Battery indicator on screen		Battery power status
No indicator	Indicator on	
AC adapter in use	Batteries in use	FULL
		↑
		↓
		EMPTY
		Batteries must be changed. Power will turn OFF.

## NOTE

- Always turn the power OFF when you open or close the battery cover or connect or disconnect the AC adapter. Doing so when the power is ON might cause recording data to be lost.
- The unit can use alkaline or NiMH batteries. The approximate operation time when using alkaline batteries is about 5.5 hours.
- Replace the batteries when "Low Battery!" is shown. Turn the POWER switch to OFF immediately and install new batteries or connect the included AC adapter.
- Set the battery type to increase the accuracy of the remaining battery charge indicator.

Reference: Setting the battery type

**P.112**

# Turning the power on & off/Setting the date & time

Follow these precautions for starting-up and shutting down the unit.  
Follow these instruction to set the date and time for files and data.

## Turning the power on and off

- 1) Make sure all the equipment is OFF.
- 2) Confirm that the power, the instruments and the monitoring system (or headphones) are correctly connected.

### Turn the power ON to start the unit

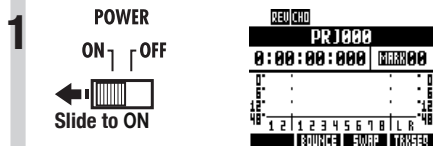

- 2 In order, turn connected instruments and the monitoring system ON.

### Turn the power OFF to shut down the unit

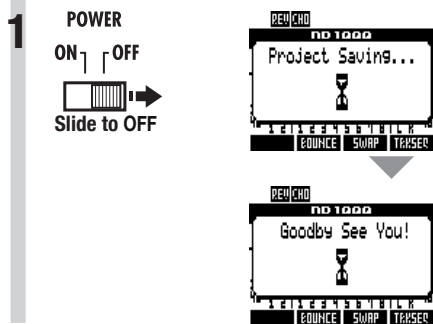

## NOTE

- Before turning the **POWER ON**, turn down the **RB PHONES** and **OUTPUT** controls and volume on monitors and other connected devices.
- If no power is supplied to the **RB** for more than a minute, the **DATE/TIME** setting will be reset to the default value.

## Setting the date and time TOOL > SYSTEM > DATE/TIME

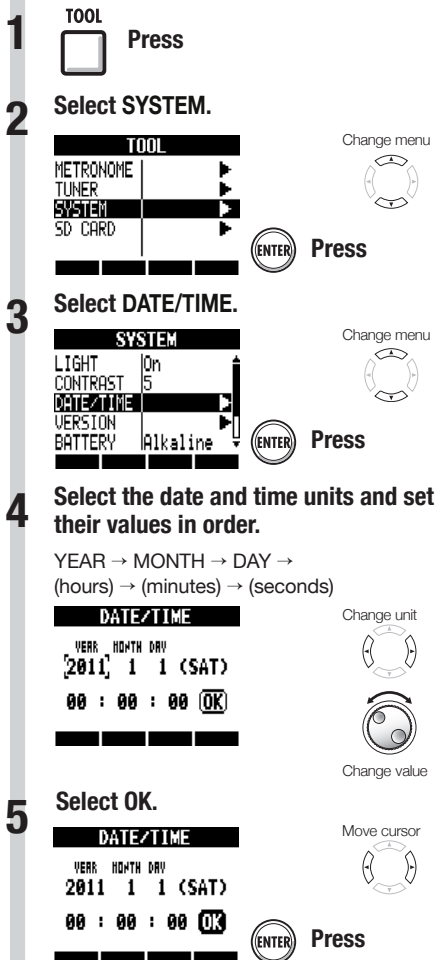

## If this message appears

Reset DATE/TIME

- The **DATE/TIME** setting has been set to its default value. Set the **DATE/TIME** again.

## Recorder overview

The **RB** is an 8-track recorder that can record up to 2 tracks at the same time and play back up to 8 tracks at the same time. The following types of tracks are used.

Track type	Function	Reference
Audio track	Plays its audio file from beginning to end.	–
Loop track	Plays part of an audio file repeatedly.	Using the sampler function (P.60)
Rhythm pattern track	Plays a rhythm pattern.	Using the rhythm function (P.48)

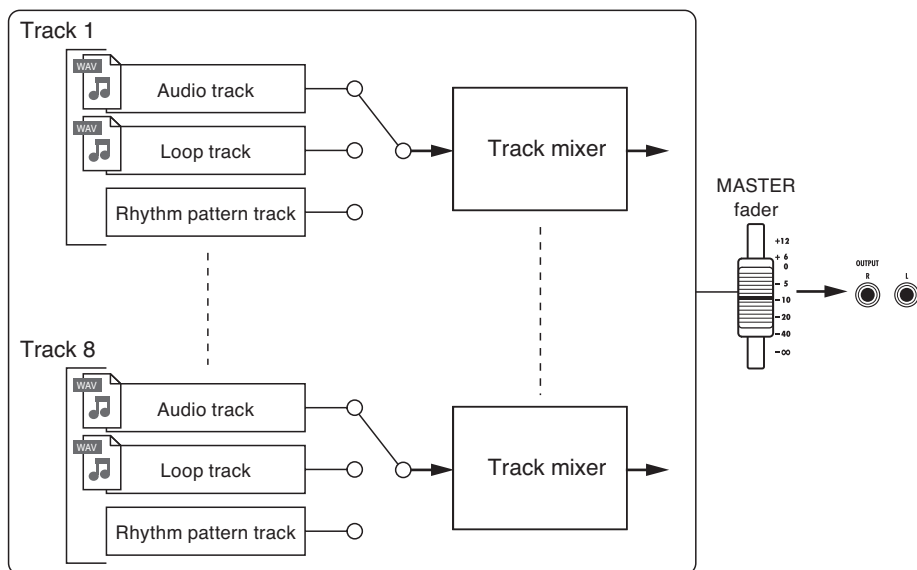

### Types of recording files

Depending on the recording destination track, the **RB** creates the following types of audio files.

- Mono track: mono WAV file
- Stereo linked track: stereo WAV file

The file format depends on the project and bit length settings.

### Types of playback files

Both mono and stereo WAV files can be assigned to **RB** audio and loop tracks. (A file cannot be assigned to a project, however, if its sampling rate is different from that of the project.)

Audio files created in DAW software can also be played by the **RB**.

There is no limit to the number of virtual tracks. Any audio file in the same project can be assigned to a track.

When a stereo file is assigned to a track, stereo link is turned on automatically.

 Reference: Changing the recording format

P97

# Preparations before recording

With the **RS** you can manage each song as a "project."  
 Before starting to record a new song, create a project first, and adjust the time signature (default: 4/4) and tempo (default: 120.0) as necessary.  
 You can also set the metronome as you wish to use as a guide during recording.

## Creating a new project

Create a new project. You can choose to use the same settings as the previous project and set the sampling rate.

**1** PROJECT  Press

**2** Select NEW.

PROJECT  
 NEW  
 SELECT  
 INFO  
 COPY  
 DELETE

Change menu

(ENTER) Press

**3** Select NAME.

NEW PROJECT  
 NAME PRJ003  
 SETTING Continue  
 RATE 44.1kHz  
 EXECUTE

Change menu

(ENTER) Press

**4** Change the name as needed.

NEW PROJECT NAME

PRJ003

(OK) ENTER (CANCEL) EXIT

DELETE INSERT

Move cursor

Delete character

Insert character

Change character

(ENTER) Press

**5** Set whether or not to continue using the previous settings.

NEW PROJECT  
 NAME PRJ003  
 SETTING Continue  
 RATE 44.1kHz  
 EXECUTE

Change menu

Change setting

**6** Set the sampling rate.

NEW PROJECT  
 NAME PRJ003  
 SETTING Continue  
 RATE 44.1kHz  
 EXECUTE

Change menu

Change setting

**7** Select EXECUTE.

NEW PROJECT  
 NAME PRJ003  
 SETTING Continue  
 RATE 44.1kHz  
 EXECUTE

Change menu

(ENTER) Press

## NOTE

- You can continue to use the settings and values of the last project in the new one.

Settings carried over with Continue
BIT LENGTH settings
INSERT EFFECT settings
Send-return EFFECT settings
Track status (PLAY/MUTE/REC) settings
BOUNCE settings
Track parameter settings
METRONOME settings
Reset
Default settings are used for each item.

The RATE can also be set to a sampling rate that is suitable for DVD audio.

RATE: sampling rate settings	
44.1 kHz	Standard (default)
48.0 kHz	For DVD audio, etc.

When set to 48 kHz, effects cannot be used.



## Changing the time signature

Use the track sequencer to set the time signature. The default is 4/4. Follow these steps to change to a different time signature.

1

TRACK



Press

2

Select TRK SEQ.



Change menu



Press

3

Start step input.



Press

REC

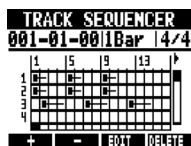

4

Move the cursor to where you want to change the time signature.

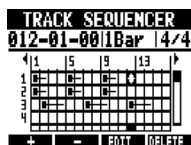

Move cursor



Go back 1 step

REW



Go forward 1 step

FF

Put the cursor at the beginning to change the time signature for the whole song, or at the point where you want to change it in the middle of the song.

5

### Move to the time signature area and change the setting.

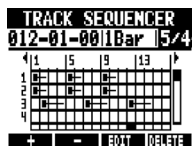

Move between areas



Change setting

Time signature options	
Setting	
1/4-8/4	Default: 4/4

6

### Complete the setting.



Press

STOP

## Delete an inserted time signature

1

### Move the cursor to where you want to delete the time signature.

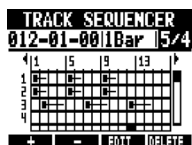

Move cursor



Go back 1 step

REW



Go forward 1 step

FF

2

### Move to the time signature area

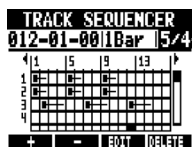

Move between areas



3

### Press beneath **DELETE**.

## Setting the tempo

1

TEMPO



Press

2



Turn the dial to change the setting.

OR

TEMPO



Tap repeatedly and the average tempo will be detected and set.



Tempo setting range

40.0-250.0

Default: 120.0

## NOTE

- The tempo setting is saved for each project.

## Using the metronome

You can change the volume, tone and stereo position of the metronome and use its pre-count function. You can also set it to only be heard through headphones.

- 1** **TOOL** Press
- 2** **Select METRONOME.**

**TOOL**

METRONOME ▶

TUNER ▶

SYSTEM ▶

SD CARD ▶

Change menu
- 3** **Select each menu item and adjust the settings.**

**METRONOME**

ON/OFF Off

LEVEL 50

PAN Center

SOUND Bell

PRE COUNT Off

Change menu

Change setting

### HINT

Use the **METRONOME** switch to change and adjust the metronome output.

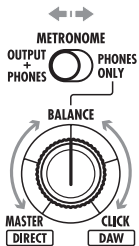

### OUTPUT + PHONES

The metronome sound is output through both **OUTPUT** and **PHONES** jacks.

### PHONES ONLY

The metronome sound is output only through the **PHONES** jack. Use the **BALANCE** knob to adjust the relative volumes of the **MASTER** fader signal and the metronome sound.



Metronome settings are saved for each project. You can use the metronome even when playing back the master track.

## Menu settings and setting values

ON/OFF: Set when operative	
Settings	
Play Only	During playback only
Rec Only	During recording only
Play & Rec	During both playback and recording
Off (default)	No metronome sound
LEVEL: Set the volume	
Setting range	
0–100	Default: 50
PAN: Set the stereo position	
Setting range	
L100 – R100	Default: Center
SOUND: Set the sound	
Settings	
Bell (default)	Click with bell accent
Click	Click sound only
Stick	Drum stick sound
Cowbell	Cowbell
Hi-Q	Synthesized click sound
Track1 – Track8	TRACK 1–8 sound (mono)
Track1/2 – Track7/8	TRACK 1/2–7/8 sound (stereo)
PRE COUNT: Set the count-in length	
Settings	
Off	None (default)
1–8	Enable pre-count sound for 1–8 beats.
Special	

### NOTE

- Be aware that if the metronome volume is set high, the accented beat of some sounds might become difficult to distinguish.
- If a track with a rhythm pattern assigned to it is selected in the **SOUND** setting, no sound will be output.
- The metronome follows the time signature used in the track sequencer.

# Recording the first track

After preparation, ready the recorder and start recording the first track in a project that you have created. Connect an instrument, record it and play back the recording. You can also apply various effects (insert) during recording.

## Connecting instruments

### Connecting passive-type guitars

Connect a high impedance instrument to **INPUT 1**, and set the input switch to **GUITAR BASS (Hi-Z)**.

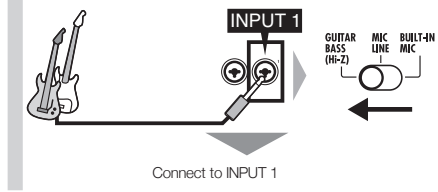

### Connecting low impedance instruments

Connect a low impedance instrument to **INPUT 1** or **2** and set its **INPUT** switch to **MIC LINE**.

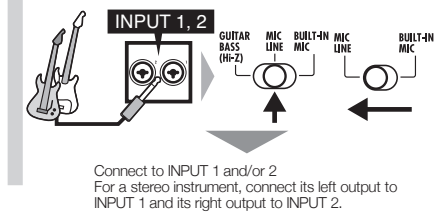

## Using phantom power

Connect a mic to an **INPUT (1 or 2)**, and set that **INPUT** switch to **MIC LINE**. Then, set the **PHANTOM** switch to **ON**.

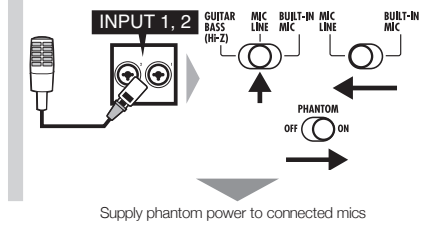

## Using the built-in mics

To use the left built-in mic set switch 1 to **BUILT-IN MIC**. To use the right built-in mic set switch 2 to **BUILT-IN MIC**.

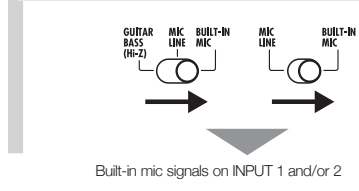

## NOTE

The total recordable time depends on the recording format and SD/SDHC card capacity. The table below shows times in hours and minutes.

Recording format	SD/SDHC card capacity					
	1 GB	2 GB	4 GB	8 GB	16 GB	32 GB
16-bit/44.1 kHz	3:07	6:14	12:28	24:56	49:53	99:46
16-bit/48 kHz	2:51	5:43	11:27	22:55	45:50	91:40
24-bit/44.1 kHz	2:04	4:09	8:18	16:37	33:15	66:30
24-bit/48 kHz	1:54	3:49	7:38	15:16	30:33	61:06

- Times are estimates for mono (1-track) recording. Times are halved for stereo (2-track) recording.
- The maximum continuous recording time, regardless of the number of recording tracks, is about 6 hours for 16-bit/44.1 kHz WAV format and about 4 hours for 24-bit/44.1 kHz WAV format.

## Adjusting the input gain

- 1 Push the **INPUT ON/OFF** switch for the connected input to turn it on, lighting the indicator red.



When red, input is possible

- 2 Adjust the input **GAIN**.



**Make noise!**

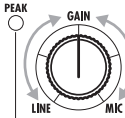

**Adjust the input gain**

Adjust so it does not light when maximum volume is input

## NOTE

- The **PEAK** indicator turns red when the signal exceeds the maximum detectable level of 0 dB, resulting in input clipping.
- If clipping happens, the recorded sound will be distorted, so you should reduce the recording level.

## Using insert effects

**1** EFFECT  Press

**2** Press  below **INSERT**.

**3** Select ON/OFF and set it to ON.

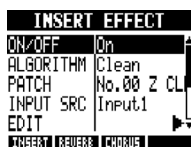

Change menu



Change setting

**4** Select an algorithm and patch.



Change menu



Algorithm or patch

**5** Select INPUT SRC and then set the connected input.



Change menu



Set the input source

**6**  Press to return to the top screen.



**7** Adjust the recording level.

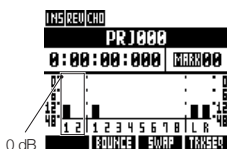

ON/OFF



When applying an insert effect, adjust the recording level so that the level meters do not touch the 0 dB mark and the input section ON/OFF switch indicators do not blink (see the following page).

## NOTE

- For more information about algorithms, patches and insert effects, see the "Guide to using effects" on P.80.
- You can also use insert effects just for monitoring while recording the unaffected signals. (See "Using effects only for monitoring" on P.89.)

## Adjusting the recording level

1  Press

TRACK1	
PAN	Center
EQ HI	0dB
EQ MID	0dB
EQ LO	0dB
REV SEND	0

2  ON/OFF  
Press  for an INPUT to adjust its recording level.

INPUT1	
PAN	Center
REV SEND	0
CHO SEND	0
REC LEVEL	100

3 Select REC LEVEL and adjust the recording level.

INPUT1	
PAN	Center
REV SEND	0
CHO SEND	0
REC LEVEL	100

Change menu



Change setting

ON/OFF

Set the recording level so that the ON/OFF switch indicator does not blink.

**Selecting tracks for recording**

**1** Press the status key for the recording destination track until it lights red.

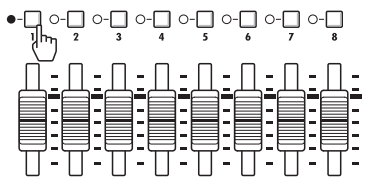

**2** Set both the MASTER and recording track faders to 0 dB once, and then raise them to adjust the monitoring volume of the instrument being recorded.



**NOTE**

● The relationship between inputs and tracks is as follows.

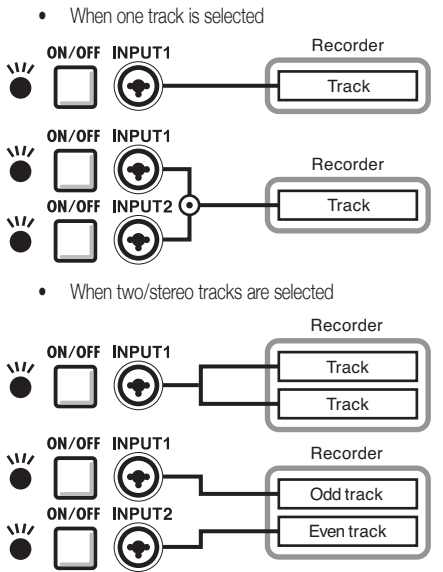



## Recording

1 Return to the beginning of the song (time counter).

Press and hold  and press  to return to the beginning.

Top screen

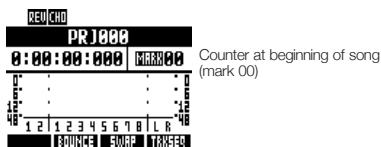

2 Arm the track for recording.

 Press  Lit red

3 Start recording.

 Press  Lit red  Lit green

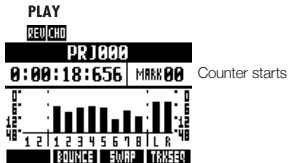

4 Stop recording.

 Press  Lit green  Unlit

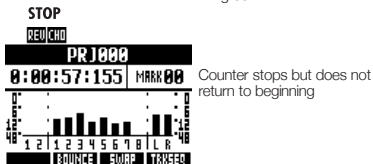

## Re-recording

If you record again on the same track, the previously recorded file will be overwritten. However, you can also use the **UNDO** function to erase the previous recording.

Moreover, you can also keep the previous file and record a second take in a separate file.

## HINT

- You can set whether when recording previous recordings are overwritten or saved and a new recording made. (See "Setting the recording mode" on P.97.)

## Redoing the previous recording (UNDO and REDO functions)

If you are not happy with a performance or the recording level setting was incorrect, for example, use the **UNDO** and **REDO** functions to re-record. Use the **UNDO** function to erase the recording and restore the unit to the previous state. You can also use **REDO** to cancel the **UNDO** operation.













Press  beneath  to UNDO.

Press  beneath  to REDO.

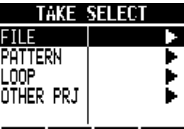
## NOTE

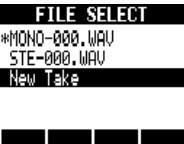
- The **UNDO** function only affects audio data recorded on a track.
- UNDO** can only be used to go back one recording step. Undoing more than one step is not possible.







## Recording to a new file

- 1 **TRACK**  
 Press
- 2 **Select the track for recording the new file.**  
 Select track  
  
 Ready to PLAY when green
- 3 **Select TAKE.**  
 Change menu  
  
 Press
- 4 **Select FILE.**  
 Change menu  
  
 Press
- 5 **Select New Take.**  
 Select file  
  
  
 Press

## HINT

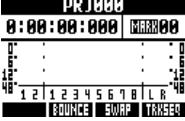
- "TAKE" shows the file name. File names are assigned automatically in order starting with "MONO-000.WAV" (for a stereo track "STE-000.WAV") followed by "MONO-001.WAV", "MONO-002.WAV" and so on. File names can be changed as necessary. (See "Changing project and audio file names" on P.94.)

## Playing back recordings

- 1 **Press the status key for the recording destination track until it lights green.**  
 Playback track  
 Press 1-2 times until lit green
- 2 **Return to the beginning of the song.**  
 Press REW while pressing and holding STOP to return to the beginning.
- 3 **Start playback.**  
   
 Press  Lit green
- 4 **Stop playback.**  
 Press  Lit green

## NOTE

- When the REC MODE is set to Overwrite, the recorded audio file will be overwritten on the track. If you return to the beginning of the song and record, the previous recording will be overwritten, so be careful. When a track is ready to PLAY, the file on it will be played back.

## HINT

- You can change the playback file to a different take. ("Changing the playback take" on P.30.)

# Overdubbing

After "Recording the first track," you can record (overdub) other instruments on other tracks while playing back the already recorded audio.

## Playing an already recorded track

Press the status key for the track to playback 1–2 times until its indicator lights green.



Press for the track to playback until it lights green

—Lit green: ready to PLAY

## Overdubbing

After preparing the already recorded track for playback, follow the instructions in "Recording the first track" (P.21) from "Connecting instruments" to "Recording" to record other tracks.

## HINT

- If you want to record on a track that has already been recorded on, assign the recorded file to another track to make the target track empty. Refer to "Changing the playback take" (P.30).
- You can also swap recorded tracks with unrecorded tracks. Refer to "Swapping two tracks" on (P.31).
- To make a new recording on the same track used for the first recording, you must swap tracks.
- To record to a new file, set the track to New Take. (Refer to "Recording to a new file" on P.27.)

## Playing back all tracks

1 Press the status keys for the tracks to playback 1–2 times until their indicators light green.



Press for the tracks to playback until they light green

—Lit green: ready to PLAY

2 Press and hold  and press  to return to the beginning.

3  Press to start playback.

PLAY  
▶ Lit green

4  Press to stop playback.

STOP  
■ Lit green

## NOTE

- When you move files on tracks, confirm that tracks to be recorded on are set to "New Take" so that no files are assigned to them.
- If there is a file assigned to a track, that recording will be overwritten by new recording.
- When the REC MODE is set to Overwrite, the recorded audio file will be overwritten on the track. If you return to the beginning of the song and record, the previous recording will be overwritten, so be careful. When a track is ready to PLAY, the file on it will be played back.

# Stereo recording (stereo link)

Enable stereo links to treat two adjacent tracks (1/2, 3/4, 5/6 and 7/8) as stereo tracks. When stereo link is set to ON, INPUT 1 and 2 can be used together for stereo input and recorded to a stereo track. When recording to a stereo track, a stereo WAV file is created.

## Stereo link

PAN/EQ > ST LINK

- 1 **PAN/EQ**  
 Press
- 2 **Select a track.**  

TRACK1	
PAN	Center
EQ HI	0dB
EQ MID	0dB
EQ LO	0dB
REV SEND	0



- 3 **Select ST LINK.**  

TRACK1	
EQ LO	0dB
REV SEND	0
CHO SEND	0
FADER	100
ST LINK	Off

- 4 **Select On.**  

TRACK1/2	
EQ LO	0dB
REV SEND	0
CHO SEND	0
FADER	100
ST LINK	On

Tracks with a stereo link are shown this way



### HINT

- Stereo link changes the setting from two mono tracks to one stereo track.
- Whatever track number you choose, an adjacent track will be linked. You cannot change these combinations.
- To adjust the volume of a stereo track, use the odd number fader. The even number fader has no effect. Use the pan parameter to adjust their relative volume balance.
- Stereo files can be assigned to stereo linked tracks. The left channel is on the odd track and the right is on the even track.

### NOTE

- If stereo link is turned on for a track that has a mono file assigned to it, that file assignment will be canceled.

## Stereo recording

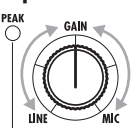
- 1 **ON/OFF**  
 Push the INPUT 1 and 2 ON/OFF switches to turn them on, lighting their indicators red.
- 2 **Adjust the input GAIN.**  



**Make noise!**

Adjust so it does not light when maximum volume is input
- 3 **Press a status key of the stereo linked tracks 1-2 times until both indicators light red.**  

Lit red: ready to record
- 4 **Set the MASTER and recording track faders to 0 dB and then use them to adjust the monitoring level of the instrument being recorded.**  

- 5 **Follow the procedures in the "Recording" section (P.26) of "Recording the first track" to record.**
  - The left channel is recorded on the odd track and the right on the even track.

# Changing playback takes

You can assign audio files to tracks freely.

By recording multiple takes of vocals, guitar solos and other parts in different files, you can later select and use the best takes (as though using virtual tracks).

1

TRACK



Press

2

Select the track to assign.



Select track

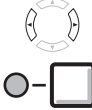

3

Select TAKE.



Change menu



Press

4

For an audio file, select FILE.

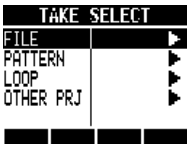

Change menu



Press

5

Select the audio file.

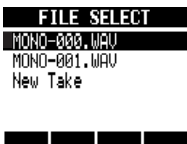

Select the file or pattern



Press

## NOTE

- If you assign a stereo file to a mono track, stereo link is turned on automatically. For example, if mono files are assigned to tracks 1 and 2, the stereo file will be assigned to track 1 and the mono file on track 2 will become unassigned.
- If you assign a mono file to a stereo track, stereo link will be turned off automatically.

## HINT

- You can also play the audio file being selected.



Play



Stop

- Files that are already assigned to tracks have an \* to the left of their names.

# Swapping two tracks

Use the swap function to exchange two tracks, including their assigned files, track sequence data and all track parameter information.

**1** Press  beneath **SWAP**.



**2** Select the first track to swap.



Indicators blink orange on tracks that can be selected. Press the status key of the track to swap.

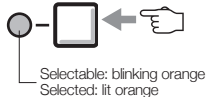

**3** Select the second track to swap.

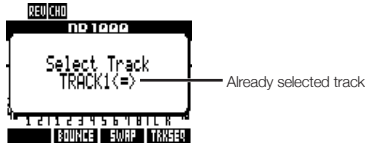

Indicators blink orange on tracks that can be selected. Press the status key of the track to swap.

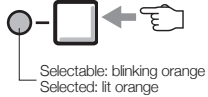

**4** Swap the tracks.

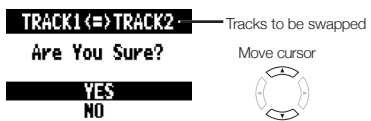

 Press

## Re-recording part of a track (punch-in/out)

Punch-in and punch-out allow you to re-record a single part of a recorded file. The point when the unit switches from playback to recording is the "punch-in" and the point when the unit switches from recording to playback is the "punch-out."

The **RS** allows both manual punch-in/out using keys on the front panel or a ZOOM FS01 footswitch (sold separately) and automatic punch-in/out in which you designate the punch-in/out points in advance.

### Manual punch-in/out

You can punch-in/out manually. During playback, press the REC key to start re-recording from that point.

### Prepare the track that you want to punch-in/out

- 

Raise the fader on the track you want to re-record.
- 

Press the status key 1-2 times until lit red.

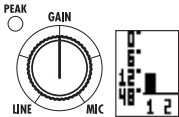
Lit red: ready to record
- 

Adjust the recording level and the GAIN to be the same as the already recorded part.

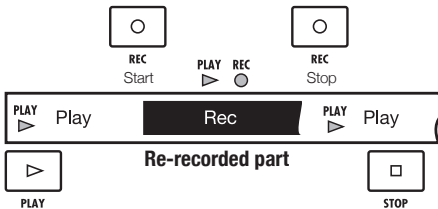



### Re-record by punching in and out

- 

Locate to before the punch-in point.
- 

Press PLAY to start playback.

PLAY Lit
- 

Perform (not recording)
- 

Press REC to punch-in and start recording.

PLAY Lit REC Lit
- 

Perform (recording)
- 

Press REC to punch-out, stop recording and start playback.

PLAY Lit REC Unlit
- 

Press to stop playback (and recording if not yet stopped).

PLAY REC Unlit



### NOTE

- Punch-in/out overwrites the recording on the track.
- If the track is set to **New Take**, the track will be silent before punching in and after punching out.
- If the REC MODE is set to **Always New**, a new file will be recorded.
- Use the **UNDO** soft key to cancel the re-recording.



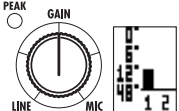

## Automatic punch-in/out

When punching in and out manually is difficult, you can set the points in advance to punch-in and punch-out automatically.

### Prepare the track that you want to punch-in/out

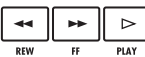
-  **Raise the fader on the track you want to re-record.**
-  **Press the status key 1-2 times until lit red.**  
Lit red: ready to record
-  **Adjust the recording level and the GAIN to be the same as the already recorded part.**

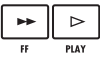



### Set the punch-in/out points

-  **Locate the starting (punch-in) point.**
-  **Press to set the punch-in point.**  
 Appearance on display
-  **Locate the ending (punch-out) point.**
-  **Press to set the punch-out point**  
 Appearance on display

## NOTE

- Once you set automatic punch-in and out points, you cannot change them. Cancel them first if you need to set them again.
- If the REC MODE is set to ALWAYS New, a new file will be recorded.







## Rehearsing

-  **Locate to a time before the punch-in point.**
-  **Press to start playback.**  
When the punch-in point is passed, the track is automatically muted. 
-  **Press to stop playback.**  
When the punch-out point is passed, the track is automatically unmuted. 

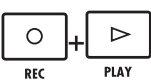
### Perform (not recording)

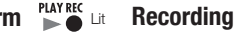
When the punch-out point is passed, the track is automatically unmuted.

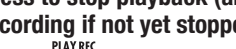
### Re-recording with punch-in and punch-out

-  **Locate to a time before the punch-out point.**
-  **Press REC and PLAY in order to start recording.**
-  **Perform**  **Recording**  
Punch-in point passed
-  **Perform**  **Recording**  
Punch-out point passed
-  **Press to stop playback (and recording if not yet stopped).**  

### Cancel punch-in/out

-  **Press**  
Indicators disappear from display

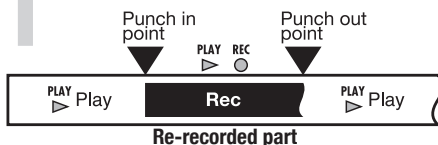









# Combining multiple tracks into 1–2 tracks (bouncing)

Bounce to mix and record multiple tracks as 1–2 tracks. This is also called “ping-pong recording.”

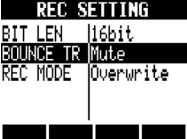

## Bounce destination track settings

PROJECT > REC > BOUNCE TR



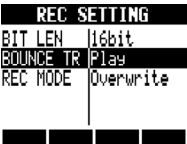

### Start from the Top Screen

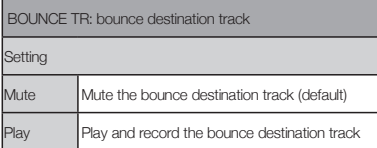
- 1  Press
- 2 **Select REC.**  

  
 Press
- 3 **Select BOUNCE TR.**  



### To include the bounce destination track

- 4 **Select Play.**  

  

- 5 **Return to the start of the project.**

## Bouncing (preparation)

- 1 **Select the bounce source tracks (set each track to play back).**  
 Press 1–2 times until indicator lights green  
 Lit green: ready to PLAY
- 2 **Select bounce destination track(s).**  
 Press 1–2 times until indicator lights red  
 Lit red: ready to record

## HINT

- Bouncing creates a new file in the same project.
- If you set the bounce destination to a mono track, the recorded signals are mixed to mono. If set to a stereo linked pair of tracks, the recorded signals will be mixed to stereo.
- You can also include signals input through the INPUT jacks when bouncing.
- For information about adjusting sounds and using effects while bouncing, refer to "Mixing" on P.40.

## Bouncing (execution)

- 3 Press  beneath **BOUNCE**.



BOUNCE ON appears on the display

Note: Press the BOUNCE soft key again to cancel bounce mode.

- 4 Press and hold  and press  to return to the beginning.

- 5  +  Press in order to start recording.

 Lit red     Lit green

- 6  Press to stop playback.

## Adjust the mix balance (audition)

- 1  Press to start playback.

- 2 Adjust the mix balance, including volume, pan and EQ, for each track.

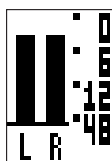

Make sure that the MASTER level meters do not reach 0 dB



- 3  Press to stop playback.

## Playback the track after bouncing

- 1 Enable playback of bounce destination tracks.

-  Press status keys 1–2 times until indicator lights green

— Lit green: ready to PLAY

- 2 Disable playback of bounce source tracks

-  Press status keys 1–2 times until unlit

— Unlit: muted

- 3 Press and hold  and press  to return to the beginning.

- 4  Press to start playback.

## NOTE

- This operation can be undone by pressing the UNDO soft key.
- If you bounce in stereo to two mono tracks, the pan of the odd number track will be set to L100, and the even number track will be set to R100.

# Locating to the desired part of a song

The counter on the display can be used to move (locate) to the desired time in hours: minutes: seconds: milliseconds or bars–beats–ticks (1/48 beat). You can also set marks in a project to locate to them easily.

## Using the counter to locate

To prepare, stop the recorder, select the project and start from the Top Screen.

### 1 Select the hours: minutes: seconds or bars–beats–ticks.

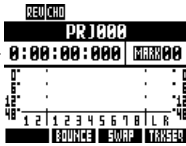

Change unit/digit



Change display



Hours: minutes: seconds: milliseconds\*  
or "Bars–beats–ticks"

### 2 Change the values.

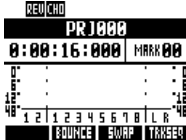

Change numbers



## NOTE

- You cannot change the counter this way during recording or playback.

## HINT

- After Step 2, you can start playback from the set counter position.
- Mark icon display
- Mark zero MARK00 is always set at counter 0 (project beginning) and cannot be changed.

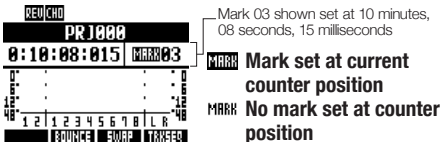

- If you add a mark at a time earlier than an existing mark, all the following marks will be automatically renumbered in order.
- One project can have a maximum of 100 marks, including the zero mark.

## Adding marks

Add a mark using the counter

### 1 Start from the top screen. Set the counter to the desired mark position.

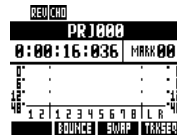

Change unit/digit



Change display



### 2 Press

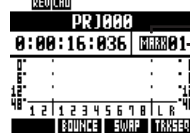

Adding a mark during recording/playback

### 1 Start recording or playback



### 2 Press



## Locate to the position of a mark

Use keys to move between marks in order

- 1 Press the and keys to set the desired mark.



Project

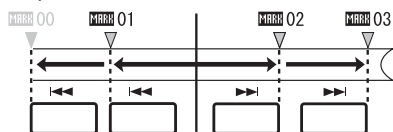

- 1 Select MARK.



Change unit/digit



Blinking

- 2 Select the mark number.

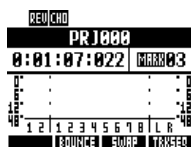

Change number



## Deleting marks

- 1 Press the and keys to set the desired mark.

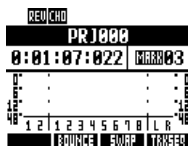

Mark icon highlighted

- 2 MARK/CLEAR Press



The highlighted mark is erased and the preceding mark is shown.

## NOTE

- A deleted mark cannot be recovered.
- **MARK00** at the beginning cannot be deleted.
- Press the **MARK/CLEAR** key when the mark icon is highlighted to delete that mark. Press **MARK/CLEAR** when the icon is not highlighted to create a new mark at that position.
- When marks are added and deleted between other marks, all the marks are automatically renumbered in order from the beginning.

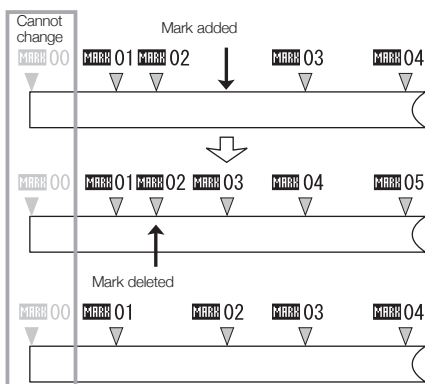



# Repeat playback of a specific section (A-B repeat)



You can set a beginning (A) point and an ending (B) point in a project and repeat playback between them.

## Setting A-B points

**1**  **Locate the beginning point**

**2** **A-B REPEAT** **Press**  
  
 Appearance on display

**3**  **Locate the end point.**

**4** **A-B REPEAT** **Press**  
  
 Appearance on display

## Use A-B repeat to loop playback

**5**  **Press to start playback.**  
 PLAY

**6**  **Press to stop playback.**  
 STOP

## Cancel repeat and clear points

**7** **A-B REPEAT** **Press to cancel**  
  
 Indicators disappear from display

## HINT

- When playback reaches point B, it automatically returns to point A and continues playback.
- While the A-B REPEAT icon appears, playback repeats continuously
- These settings can be made both during playback and when stopped.
- If you set point B at a time before point A, repeat playback will occur from point B to point A.
- To change the settings, press the **A-B REPEAT** key to cancel them once and then follow the procedures to set new ones.

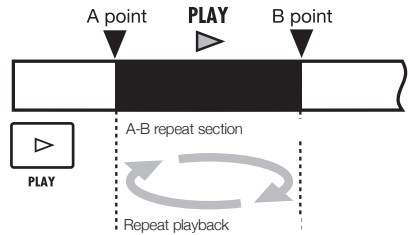



# Mixing overview

The **RB** has two built-in mixers. Input signals are sent to the input mixer, and track playback signals are sent to the track mixer.

Using the built-in mixer, you can adjust the volume and pan for each input signal and track, as well as use a 3-band parametric equalizer on the tracks.

## Input mixer

This mixer adjusts the input gain of each signal input through an **INPUT** jack, and sends each signal individually or both mixed together to a recorder track.

You can control the following **INPUT** parameters and monitor up to 8 playback tracks at the same time.

- Input signal pan (PAN)
- Send-return effect levels (REV SEND, CHO SEND)
- Input signal recording level (REC LEVEL)

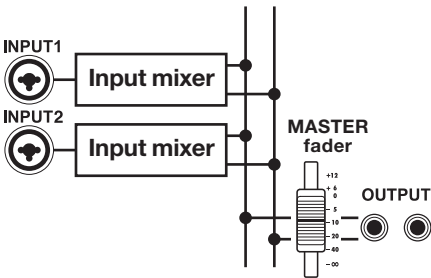

## Track mixer

This mixer mixes the output signals of recorder tracks to stereo.

Use the faders to adjust the volume. You can also adjust the pan and equalizer, for example, for each track.

You can control the following types of parameters using the track mixer.

- Track volume (FADER)
- Track pan (PAN)
- Equalizer (EQ HI, EQ MID, EQ LO) (EQ cannot be adjusted for rhythm pattern tracks)
- Send-return effect levels (REV SEND, CHO SEND)
- Stereo link settings (for mono audio tracks)
- Track phase (INVERT) (the phase of rhythm pattern tracks cannot be adjusted)

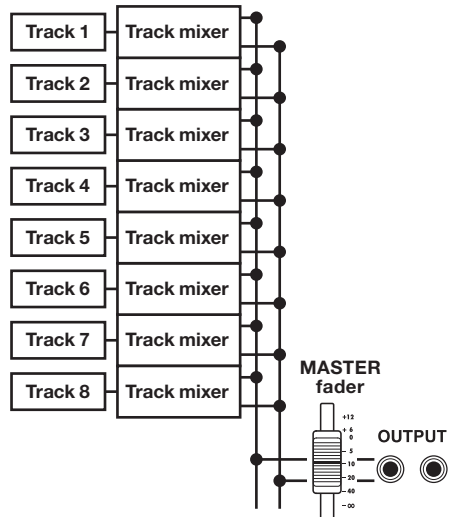

## Input signals and mixers

### If recording destination track is set

When the recording destination track has been set, the input signal does not pass through the input mixer. Instead, after passing through the REC LEVEL, the signal passes through the track mixer and is output.

Example: track 1 selected

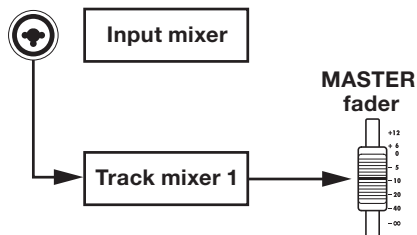

### If recording destination track is not set

When the recording destination track has not been set, the input signal passes through the input mixer and is output.

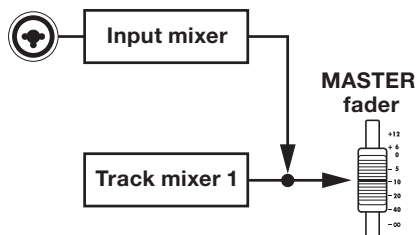



# Setting track level, EQ and pan

Use the input and track mixers to set track parameters that, for example, adjust pan and effect send levels for each track. Here, we explain the adjustment of track parameters.

**1** PAN/EQ  Press

**2** Select an input or track.

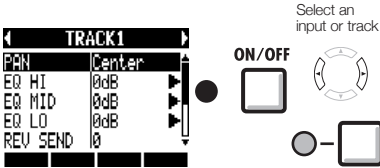

**3** Select a menu item and its setting.

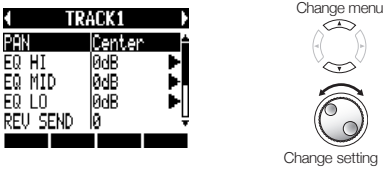

**4** Select EQ HI, EQ MID or EQ LO.

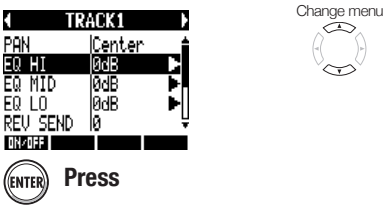

**5** Select each item and change settings.

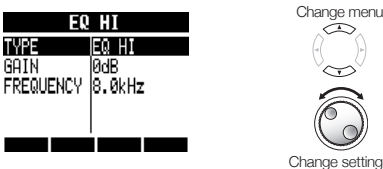

## NOTE

- Except for phase settings (INVERT), both left and right channels of stereo tracks share the same parameter values.
- Settings are stored separately for each project.
- The only setting for the MASTER track is volume (FADER level).
- Rhythm pattern tracks do not have EQ HI, EQ MID, EQ LO, ST LINK or INVERT settings.

The parameters that can be set for each type of track are as follows.

Mono tracks: 1-8  
Stereo tracks: 1/2-7/8

Display	Parameter	Setting range (default value)	Explanation	Mono tracks	Stereo tracks	Master track
PAN	PAN	L100-R100 (Center)	Adjusts a track's PAN. For stereo tracks adjusts the volume balance between the left and right channels.	<input type="radio"/>	<input type="radio"/>	
EQ HI	High-frequency range boost/cut					
EQ HI	TYPE	EQ HI, HI CUT (EQ HI)	Set whether to boost/cut the high-frequency range (EQ HI) or clearly cut unnecessary high frequencies (HI CUT). This parameter can only be accessed when EQ HI is on.	<input type="radio"/>	<input type="radio"/>	
	GAIN	-12dB~12dB (0dB)	Adjust amount of boost/out of high frequencies by -12 ~ +12 dB. This parameter is shown only when the TYPE is set to EQ HI. When set to HI CUT, it is not shown.	<input type="radio"/>	<input type="radio"/>	
	FREQUENCY	500Hz~18kHz (8.0kHz)	Adjust the EQ boost/cut frequency of high frequencies. This parameter can only be accessed when EQ HI is on.	<input type="radio"/>	<input type="radio"/>	
EQ MID	Middle-frequency range boost/cut					
EQ MID	GAIN	-12dB~+12dB (0dB)	Adjust amount of boost/out of middle frequencies by -12 ~ +12 dB. This parameter can only be accessed when EQ MID is on.	<input type="radio"/>	<input type="radio"/>	
	FREQUENCY	40Hz~18kHz (1.0kHz)	Adjust EQ boost/cut frequency of middle frequencies. This parameter can only be accessed when EQ MID is on.	<input type="radio"/>	<input type="radio"/>	
	Q	0.1~2.0 (0.5)	Adjust the width of the middle frequency band affected. This parameter can only be accessed when EQ MID is on.	<input type="radio"/>	<input type="radio"/>	
EQ LOW	Low-frequency range boost/cut					
EQ LO	TYPE	EQ LO, LO CUT (EQ LO)	Set whether to boost/cut the low-frequency range (EQ LO) or clearly cut unnecessary low frequencies (LO CUT). This parameter can only be accessed when EQ LO is on.	<input type="radio"/>	<input type="radio"/>	
	GAIN	-12dB~+12dB (0dB)	Adjust amount of boost/out of low frequencies by -12 ~ +12 dB. This parameter is shown only when the TYPE is set to EQ LO. When set to LO CUT, it is not shown.	<input type="radio"/>	<input type="radio"/>	
	FREQUENCY	40Hz~1.6kHz (125Hz)	Adjust EQ boost/cut frequency of low frequencies. This parameter can only be accessed when EQ LO is on.	<input type="radio"/>	<input type="radio"/>	
Effect send levels						
REV SEND	REVERB SEND LEVEL	0~100 (0)	Adjust the signal level sent from the track to the reverb effect.	<input type="radio"/>	<input type="radio"/>	
CHO SEND	CHORUS/DELAY SEND LEVEL	0~100 (0)	Adjust the signal level sent from the track to the chorus/delay effect.	<input type="radio"/>	<input type="radio"/>	
FADER	FADER	0~127 (100)	Adjust the current volume.	<input type="radio"/>	<input type="radio"/>	<input type="radio"/>
ST LINK	STEREO LINK	On/Off (Off)	Switch on/off to set the stereo link function that connects two mono tracks together.	<input type="radio"/>	<input type="radio"/>	
INVERT	INVERT	On/Off (Off)	Set whether the phase of a track is inverted or not. Set it to Off to use normal phase or ON to invert the phase.	<input type="radio"/>	<input type="radio"/>	

## NOTE

- Use the ON/OFF soft key to turn EQ HI, EQ MID, EQ LO, REV SEND, CHO SEND and INVERT parameters ON/OFF.
- When a stereo link is ON, the INVERT parameter is shown as INVERT L for the odd track, and as INVERT R for the even track.

# Using send-return effects

Send-return effects, which are routed internally by the mixers, can be applied to signals input to the input and track mixers. You can adjust the send-return effect levels for each input and track using their send levels, which set the amount of signal sent to the effect.

Here we explain how to select the send-return effect patch and adjust the amount applied to each track.

## Select an effect and patch

- 1 **EFFECT**  
 Press
- 2 Press  beneath **REVERB**.  
 OR  
 Press  beneath **CHORUS**.

3 Select ON/OFF and set it to ON.



Change menu



Change setting

4 Select PATCH and choose the patch.



Change menu



Change patch

## Adjust the send-return effect levels for each track

- 1 **PAN/EQ**  
 Press
- 2 Select an input or track.

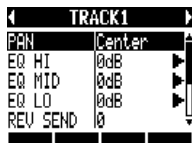

Select input or track

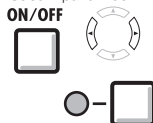

3 Select REV SEND or CHO SEND and adjust the setting.

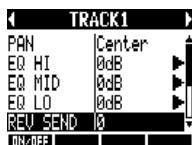

Change menu



Change setting

# Using insert effects on tracks

You can use an insert effect on already recorded tracks.

**1** **EFFECT** Press 

**Press  beneath **EFFECT** to access the insert effect**

**Accessing the effect settings**

**2** **Select ON/OFF and set it to On.**

**INSERT EFFECT**

ON/OFF	On
ALGORITHM	Clean
PATCH	No.00 Z CL
INPUT SRC	Input1
EDIT	

**Change menu** 

**Change setting** 

**3** **Select INPUT SRC and set the track.**

**INSERT EFFECT**

ON/OFF	On
ALGORITHM	Stereo
PATCH	No.07 Powe
INPUT SRC	Track1/2
EDIT	

**Change menu** 

**Change input source** 

Display	Signal source
Input1, Input2	One input
Input1/2	Both inputs
Track1–Track8	Output of one mono track
Track1/2–Track7/8	Output of one stereo track or two mono tracks
Master	Signal before the MASTER fader

**4** **Select PATCH and set it.**

**INSERT EFFECT**

ON/OFF	On
ALGORITHM	Stereo
PATCH	07 PowerBD
INPUT SRC	Track1/2
EDIT	

**Change menu** 

**Change patch** 

You can select the patch while playing back to hear the effect.

**PLAY**  **STOP** 

**5** **Press** 

# Using a mastering effect

Use a mastering effect as an insert effect to process the final stereo signal when mixing down to the master track.

Select a MASTERING algorithm to apply the effect to the signal before the MASTER fader.

## Insert an insert effect before the MASTER fader

1

**EFFECT**  
 Press

### Accessing the effect settings

Press  beneath **EFFECT** to access the insert effect

2

Select **ON/OFF** and set it to **ON**.

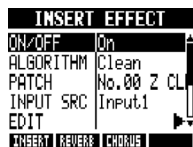

Change menu



Change setting

3

Select **ALGORITHM** and set it to **Mastering**.

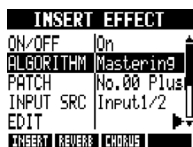

Change menu



Change setting

4

Select **INPUT SRC** and set it to **Master**.



Change menu



Change setting

5

Select **PATCH** and set it.

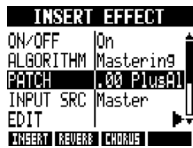

Change menu



Change setting

You can select the patch while playing back to hear the effect.



6



Press

## NOTE

- When the insert effect is applied before the MASTER fader in advance, the insert effect cannot also be applied to other tracks, either during recording or playback.
- At step 5, if you hear distortion when the mastering effect is applied to the signal, check the sound of the playback tracks and lower and readjust their faders. (If a track sound is distorted, adjust that track.)
- You can select Stereo, Dual, Mic or Mastering algorithms. If you set another algorithm, the insert position changes to Input 1.

## HINT

- Use a MASTERING algorithm effect to process the final stereo mix signal.

Master track recording signal flow

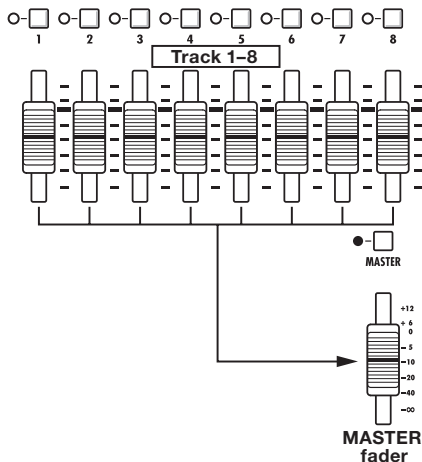

# Mixing down to the master track

Record the "final" stereo mix on the MASTER track, which is specifically for mixing down. Signals are sent to the master track after passing through the MASTER fader.

## Recording to the MASTER track

### Prepare by adjusting the signal levels

**1** Press and hold  and press  to return to the beginning. Press  to start playback.

**2** Adjust the level of the signal that passes through the master fader. Adjust the balance of the tracks during playback.

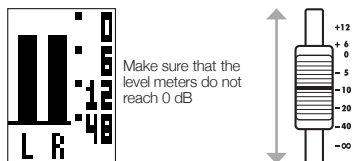

**3**  Press to stop playback.

### Record to the master track

**4**  Press the MASTER status key 1-2 times until the indicator lights red. Lit red: ready to record

**5** Press and hold  and press  to return to the beginning.

**6**  +  Press in order to start recording.

**7**  Press to stop playback.

## NOTE

- The pan, balance, insert and send-return effects of each track affect the signals sent to the MASTER track.

## Play the master track

**1**  Press the MASTER status key 1-2 times until the indicator lights green. Lit green: ready to PLAY

Doing this mutes all other tracks and disables all effects.

**2** Press and hold  and press  to return to the beginning.

 Press to start playback.

**3**  Press to stop playback.

## Disable MASTER track playback

**4**  Press the MASTER status key 1-2 times until the indicator is unlit.

Unlit: disabled Other tracks are unmuted and their status lights become as they were before.

## HINTS

- Each project can only have one active MASTER track at a time.
- You can assign an already recorded file to the MASTER track.
- Even if you mix down from the middle of a song, a new file will always be recorded.
- The signals that have passed through the MASTER fader are the same as those sent from the OUTPUT jacks.
- This operation can be undone by pressing the UNDO soft key.
- The final stereo mix recorded to the master track is saved as a WAV file. This file can be saved on a computer and, using disc writing software, for example, be written to a CD. (See "Exchanging data with a computer (card reader)" on P.103.)

 Reference: Sequential playback of projects (sequence play)

P.98

## Overview of rhythm functions

With the **RS**, you can perform rhythm parts using the built-in drum sounds.

Rhythm patterns can be assigned to tracks, and you can repeat simple patterns in place of a metronome, or perform rhythm parts for an entire song using the track sequencer function (see P.72), for example.

### Drum kits

The **RS** has 10 types of drum kits – sets of 16 types of percussion instruments, including kicks, snares and hi-hats.

Use the pads to play each different sound and create rhythm parts from them.

#### RS drum kits

BASIC
STUDIO
LIVE
ROCK
POP
FUNK
JAZZ
ACOUSTIC
TECHNO
URBAN

### Rhythm patterns

In one project, you can use 511 types of rhythm patterns. (Each pattern contains a drum performance of 1–99 bars in length.) You can edit parts of existing patterns and even create new rhythm patterns.

### Rhythm pattern tracks

To use a rhythm pattern in a song, assign the rhythm pattern to a track.

Tracks that have rhythm patterns assigned to them are called rhythm pattern tracks.

You can do the following with rhythm pattern tracks.

- Play them with the pads and set how they are played back (See "Using the pads to play rhythm patterns" on P.50.)
- Control them with the track sequencer (See "Using the track sequencer" on P.72.)
- Play back rhythm pattern tracks (See "Track playback overview" in "Using the sampler" on P.61.)



# Rhythm pattern selection

## Changing the playback pattern

Select a rhythm pattern and play it.

**1** RHYTHM  
Press

**2** Rhythm pattern selection

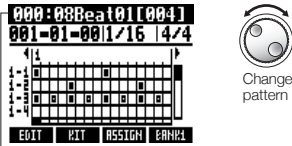

Rhythm pattern name

**3** Press to play.  
PLAY

Press to stop playback.  
STOP

Press and hold and press to return to the beginning.

## Changing the drum kit

Change the drum sounds.

**1** Press beneath **KIT**.

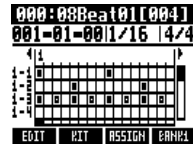

**2** Select a drum kit.

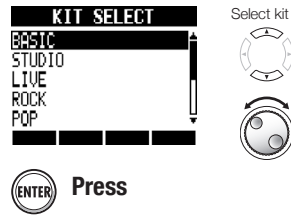

Press

## NOTE

- The drum kit setting is saved with each project.



# Using the pads to play rhythm patterns



You can play the velocity-sensitive pads beneath each of the track faders, adding accents in real time.

**1** **RHYTHM**  Press

**2** Play the pads.



## Switching banks

You can change the sounds of the pads.

Press  beneath **BANK1**.

Select **BANK1** for drum kit sounds and **BANK2** for percussion sounds.

## Repeating sounds (drum rolls)

You can set a pad sound to play repeatedly at a set interval.

This is convenient when entering hi-hat 16th notes, for example.

**1** Press  beneath **EDIT**.

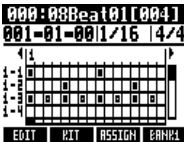

**2** Select **PAD ROLL** and set the repeat rate.



Change menu



Change setting

### PAD ROLL: repeat interval

Settings	
2/4-16/4	1/4 notes x 2-16
3/8, 1/3, 1/4, 3/16, 1/6, 1/8, 1/12, 1/16, 1/24, 1/32	Dotted 1/4 notes, 1/2 note triplets, 1/4 notes, dotted 8th notes, 1/4 note triplets, 8th notes, 8th note triplets, 16th notes, 16th note triplets, 32nd notes

**3** **REPEAT/STOP**  Press and hold **REPEAT/STOP**, and press the pad to play the roll.

If you release **REPEAT/STOP** before the pad, that sound continues rolling after the pad is released. Press the pad again to stop it.

## Adjusting the pad sensitivity

Set the pad sensitivity. You can set pads to respond to playing strength or to trigger sounds at a consistent volume regardless of how hard they are played.

**1** **TOOL**  Press

**2** Select **SYSTEM**.

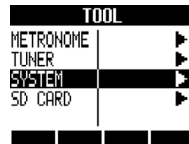

Change menu



 Press

**3** Select **PAD SENSE** and set it.

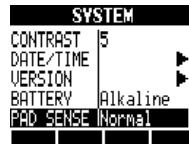

Change menu



Change setting

### PAD SENSE: pad sensitivity



Setting	
Soft	Regardless of playing strength, sounds are triggered with a soft volume.
Medium	Regardless of playing strength, sounds are triggered with a medium volume.
Loud	Regardless of playing strength, sounds are triggered with a loud volume.
Lite	Highest sensitivity—even light playing produces loud volume.
Normal	Medium sensitivity.
Hard	Low sensitivity—must play the pads hard to trigger with loud volume.
EX Hard	Lowest sensitivity—must play the pads very hard to trigger with loud volume.



# Assigning rhythm patterns to tracks

To use a rhythm pattern in a song, you must assign it to a track. A track that a rhythm pattern is assigned to is called a rhythm pattern track. Rhythm pattern tracks can be played using the pads and controlled with the track sequencer.

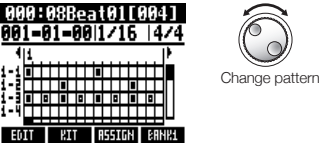

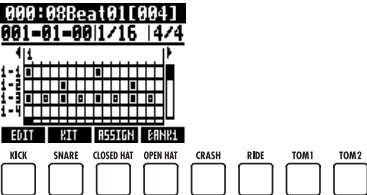

## Assigning from the RHYTHM menu

- 1** **RHYTHM**  
 **Press**
- 2** **Select a rhythm pattern**  

- 3** While pressing  beneath **RHYTHM**, press the pad of the track where you want to assign it.  

## NOTE

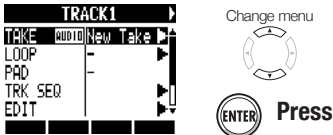
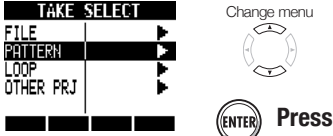

- If rhythm patterns are assigned to multiple tracks and played back simultaneously, or patterns with numerous note-on events are played, they might not all play as expected due to the maximum polyphony limitation of the unit.
- When a rhythm pattern is assigned to a track, it cannot be set to loop.
- When you press the ASSIGN soft key, the pads of tracks currently set to New Take blink.
- When you play a rhythm pattern track, the status key indicator changes from green to orange.

## Assigning from the TRACK menu

- 1** **TRACK**  
 **Press**
- 2** **Select the destination track.**  

- 3** **Select TAKE.**  

- 4** **Select PATTERN.**  

- 5** **Select a rhythm pattern**  

## HINT

- You can play the selected rhythm pattern.

-  Play the pattern
-  Stop pattern playback



# Creating a rhythm pattern

You can create your own original rhythm patterns. After preparing, you can create a rhythm pattern using real-time or step input.

## Preparing to create a rhythm pattern

Select an empty rhythm pattern and set the number of bars, time signature and quantization. You can also check the memory remaining for rhythm patterns.

### 1 RHYTHM

Press

### 2 Select an empty rhythm pattern (name is EMPTY).

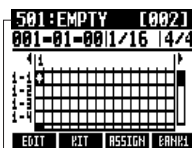

Rhythm pattern name

### 3 Move to the quantization area and set the value.

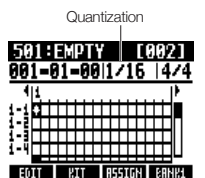

Quantization	
Setting	
1/4	Quarter note
1/8	8th note
1/8T	8th note triplet
1/16	16th note
1/16T	16th note triplet
1/32	32nd note
Hi	Tick

4 Press beneath **EDIT**.

### 5 Set number of bars and time signature.

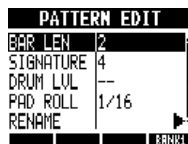

Change menu



Change setting

BAR LEN: number of bars	
Setting range	
1-99	Number of bars
SIGNATURE: time signature	
Setting	
1-8	Time signature (number of beats)
MEMORY	
Shows current amount of memory used	

### 6 Press

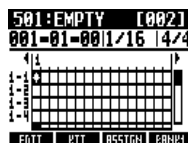

## Inputting a pattern in real-time

After preparing, play the pads along with the rhythm (metronome) to create a rhythm pattern with real-time input.

### 1

Start input. Press



PLAY

while pressing and holding



REC

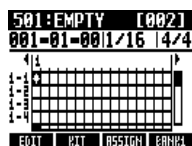

### 2

Play the pads in time with the rhythm to record the pattern.



Now Recording...



### 3

To delete sounds:

Press and hold  under **DELETE** and press a pad. While that pad is being pressed, data that has already been input for that pad will be erased.

Press  beneath **ALL DEL** to erase data that has already been input for all pads.

### 4

End input.



STOP

Press

## NOTE

- If your timing playing the pads is slightly off, it will be corrected to the rhythm in accordance with the quantize setting.
- Depending on the pad sensitivity setting, the force used to play the pads is also recorded.
- You can also set a metronome pre-count (see P.20).

## Step input of a rhythm pattern

After preparing, you can input notes one at a time (step input) to create a rhythm pattern.

### 1 Start input.



Press

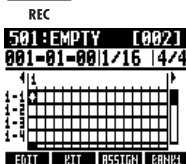

### 2 Move the cursor to the position where you want to input or delete notes.

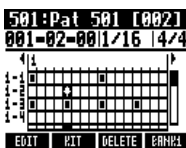

Move cursor



Go back one beat

REW



Advance one beat

FF

The horizontal axis shows the bars and the vertical axis shows the pads by number. One step (one box) is the length of the quantize setting.

### 3 Play a pad to input a note at the current position. Its volume will correspond to the strength you play it (and the sensitivity setting).



Press

Press ENTER to add a note with a fixed volume level at that position.

### 4 To delete an input a note or change its volume:

Press  beneath **DELETE** to delete the note at that position.



Turn to change the volume of the note at that position.



Loud (high velocity)



Quiet (low velocity)

Press and hold  beneath **DELETE** and press the lit pad to erase the note at that position.

### 5 End input.



Press

STOP

## NOTE

- Notes that are at locations that cannot be moved to with the current quantize setting cannot be deleted. A note at such a position appears as an "X".
- In Step 4, you can also use the dial to input and delete notes.



# Copying rhythm patterns

You can copy a rhythm pattern to create a new one based on it, for example.

**1** RHYTHM  Press

**2** Select the rhythm pattern that you want to copy.

Press  beneath **EDIT**.

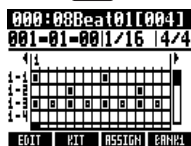

Change pattern

**3** Select COPY.



Change menu



 Press

**4** Select COPY TO.

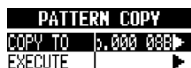

Change menu



 Press

**5** Select the copy destination.

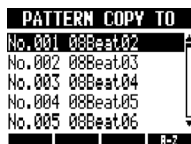

Select pattern



 Press

**6** Select EXECUTE.

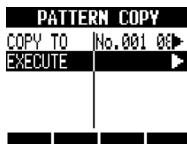

Change menu



 Press

## HINT

- In step 5, you can change the order of the pattern list.
- Press the A-Z soft key to list the patterns in alphabetical order.
- Press the No. soft key to list the patterns in numerical order.



# Deleting rhythm patterns

Rhythm patterns can be deleted.

**1** **RHYTHM**  
 Press

**2** Select the rhythm pattern that you want to delete.

Press  beneath **EDIT**.



Change pattern

**3** Select **DELETE**.



Change menu



 Press

**4** Select **YES**.

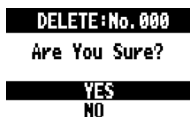

Move cursor



 Press



# Renaming rhythm patterns

You can change the names of rhythm patterns.

**1** RHYTHM  Press

**2** Select the rhythm pattern that you want to rename.

Press  beneath **EDIT**.

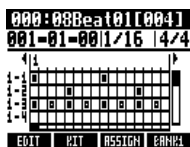

Change pattern

**3** Select RENAME.



Change menu



 Press

**4** Change the name.



Move cursor



Change character

**DELETE**

Delete character

**INSERT**

Insert character

 Press



# Importing rhythm patterns from other projects



You can import rhythm patterns from other projects.

You can import all the rhythm patterns (All) at once or one at a time (Each).

- 1** **RHYTHM** Press
- 2** Press beneath **EDIT**.
- 3** Select **IMPORT**.

Change menu

**ENTER** Press
- 4** Select **MODE** and set it to **All** or **Each**.

Change menu

Change setting
- 5** Select **PROJECT**.

Change menu

**ENTER** Press
- 6** Select the source project.

Select project

**ENTER** Press

- 7** Select **NEXT**.

Change menu

**ENTER** Press
- 8** Select the rhythm pattern to import (only when set to **Each**).

Select pattern

**ENTER** Press
- 9** Select the destination rhythm pattern to import (only when set to **Each**).

Select pattern

**ENTER** Press
- 10** Select **YES**.

Move cursor

**ENTER** Press

## NOTE

- Destination rhythm patterns will be overwritten. When set to All, all the original rhythm patterns in the project will be deleted. When set to Each, the rhythm pattern selected as the destination will be deleted.
- In step 8 or 9, you can change the order of the pattern list.
- Press the A-Z soft key to list the patterns in alphabetical order.
- Press the No. soft key to list the patterns in numerical order.



# Setting volume and stereo placement

You can change the volume of a rhythm pattern and the stereo placement of the drum kit.

**1** **RHYTHM**  
 Press

**2** Select the rhythm pattern for which you want to make settings.

Press  beneath **EDIT**.

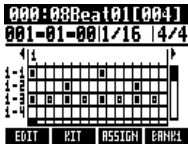

Change pattern

**3** Select a menu item and change the setting.



Change menu



Change setting

DRUM LVL: drum volume	
Setting	
1-15	Drum volume
POSITION: drum placement	
Setting	
Listener	Drums are placed from left to right as heard by the audience
Player	Drums are placed from left to right as heard by the drummer

## NOTE

- POSITION settings are saved for each project.

# Using the sampler to make songs

You can use the **RS** sampler functions to easily create backing tracks, rhythm parts and other foundation tracks that have high sound quality. These features can be used to make a wide variety of music, from demo songs to produced recordings.

## 1 Make a loop for the basic rhythm of the entire song.

Assign the included loops to tracks (pads) and set them to loop.

For example, you can develop a vision for an entire song by selecting drum loops and other materials that inspire you.

Reference:  
 Assigning included drum loops to tracks **P.63**  
 Setting loops **P.64**

## 2 As you listen to the rhythm loop that you prepared, record guitar, bass, keyboard and other instruments to create more loops.

Keep recording until you are satisfied with the performance of the riff, backing part or other musical phrase. You can loop only the parts of the recordings that you like.

Reference: Setting loops **P.64**

## 3 Repeat step 2 to record other phrases to use as loops.

Prepare all the phrases that are necessary to make your song.

## 4 When the loops are ready, play them with the pads while considering the structure of the entire song.

Play the pads with the rhythm while considering the flow of the entire song and how the loops combine.

Reference: Playing the pads **P.66**

## 5 After determining the structure of the song, create a sequence (loop performance data) for the entire song.

A sequence can be input by playing the pads along with a rhythm (metronome) in real time or input step by step. You can create basic tracks, including backing parts and rhythm parts, for an entire song this way.

Reference: Creating a sequence **P.73**

## 6 Record vocals, guitar solos and other parts as you listen to the sequence.

Record the main vocals and instruments in time with the basic tracks.

# Using the sampler

The **RS** has a sampler function that allows audio files to be played with the pads. You can use the included loops or other commercially-available loops to easily create high-quality rhythm tracks.

## Loop tracks

To use the sampler function, you must first set audio tracks to loop. When set to loop, we call these tracks "loop tracks." You can do the following with loop tracks.

- Play them with pads, and set how the loops playback when played (see "Playing the pads" on P.66)
- Conduct loop playback of a designated interval (see "Setting loops" on P.64)
- Control them with the track sequencer (see "Using the track sequencer" on P.72)

## Track playback overview

When you play audio tracks with the PLAY key, the files will usually be played until they end, but with loop tracks and rhythm pattern tracks, the designated loop interval will play back repeatedly.

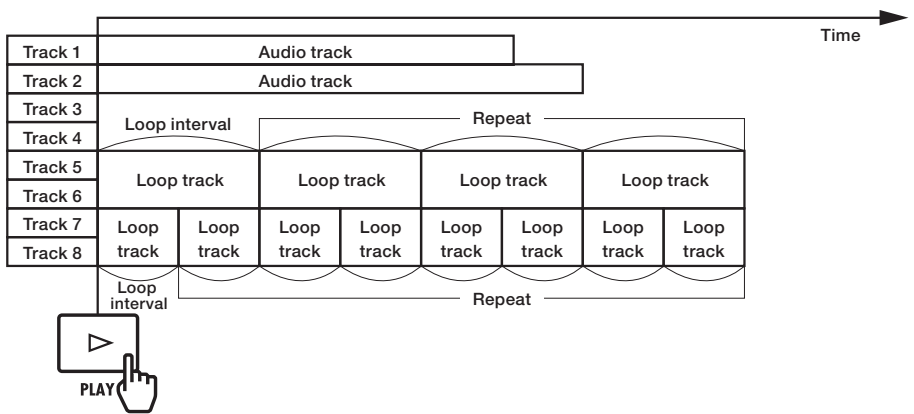

When the track sequencer is on, loop tracks and rhythm pattern tracks play back according to the sequence.

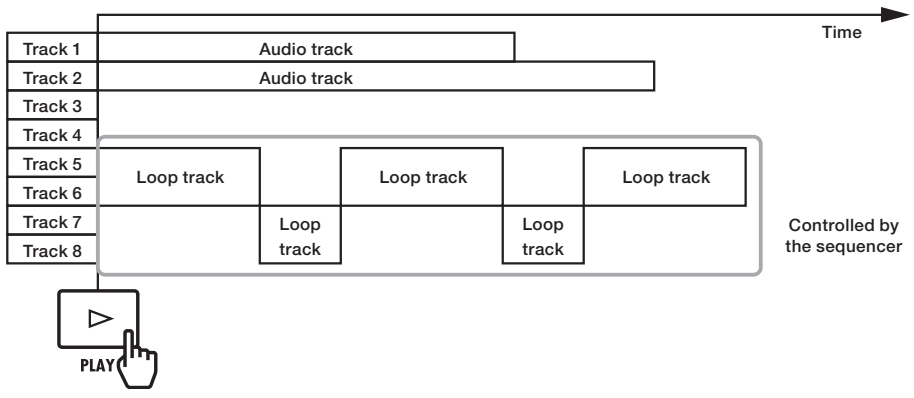

When using the pads for playback, press the pad for a loop track or rhythm pattern track to start playback of that track.  
 In the illustration below, after a pad for tracks 5/6 (loop track) is pushed to start playback, a pad for tracks 7/8 (loop track) is pushed to start playback of that loop.  
 In addition, how each loop track pad is played can be set individually (PAD parameter). In this example, they are set to "Gate", which causes playback to stop when the pad is released (see "Playing the pads" on P.66).

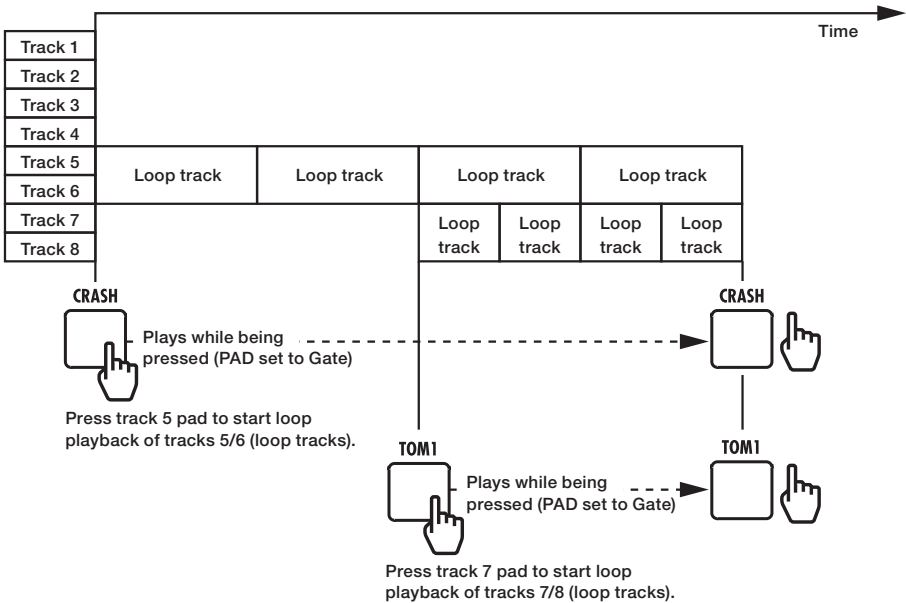



# Assigning included drum loops to tracks

To use the sampler function, first assign audio files and rhythm patterns to tracks. In this example, we explain how to assign loops that are on the included SD card.

**1** TRACK  
 Press

**2** Select the track to assign.



**3** Select TAKE.



Press

**4** Select LOOP.

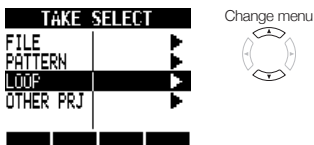

FILE	Audio files in the current project
PATTERN	Rhythm patterns
LOOP	Loops on the SD card
OTHER PRJ	Audio files in other projects

Press

**5** Select a loop.

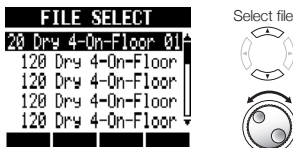

Press

## NOTE

- In a new project, the BPM (tempo) of the first audio file assigned to a track will set the BPM of the project.
- From the LOOP menu, you can select loop files in the LOOP folder on the SD card.
- The loops on the SD card are 44.1 kHz WAV files. For this reason, if the project sampling rate is set to 48 kHz, “Invalid File” appears and they cannot be assigned to tracks.

## HINT

- You can also play audio files and rhythm patterns as you select them.



**Start playback**

PLAY



**Stop playback**

STOP



# Setting loops

To use the sampler function, you must set a track to loop, making it a loop track. Here we explain how to make this setting.

## Setting a track to loop

Tracks can be individually set to loop.

**1** **TRACK**  
 **Press**

**2** **Select the track to loop.**

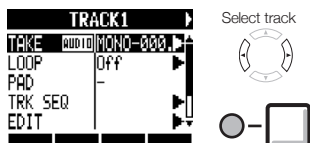

**3** **Select LOOP.**

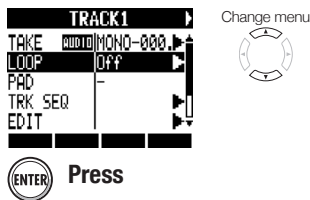

**4** **Select ON/OFF and set it to On to enable loop playback.**

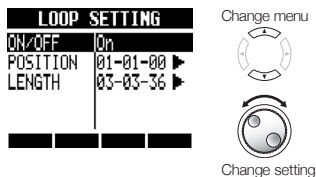

## NOTE

- The status key indicator of a track set to loop lights orange instead of green when enabled for playback. A track set to loop cannot be used to record (indicator will not light red). In addition, the following functions can be used when a track is set to loop.
  - The pad can be used to trigger the loop.
  - Pressing **PLAY** starts loop playback.
  - Sequence data can be recorded.
- When a rhythm pattern is assigned to a track, it cannot be set to loop.

## Setting the loop interval

The loop interval (starting point and length) can be set for loop tracks.

**1** **TRACK**  
 Press

**2** Select the track to be looped.

**TRACK3** Select track

TAKE	audio	MONO-004.WAV
LOOP	On	
PAD	Repeat	
TRK SEQ		
EDIT		

**3** Select LOOP.

**TRACK3** Change menu

TAKE	audio	MONO-004.WAV
LOOP	On	
PAD	Repeat	
TRK SEQ		
EDIT		



 Press

**4** Select POSITION.

**LOOP SETTING** Change menu

ON/OFF	On	
POSITION	01-01-00	
LENGTH	01-00-00	



 Press

**5** Set the loop starting point.

Starting point



**TRACK3** MONO-004.WAV Locate

1	2	3	4
---	---	---	---



**001-01-00**

**POSZ LENGTH ZOOM**

Change setting

**6** Press  beneath **LENGTH** to set the length of the loop.

Length

**TRACK3** MONO-004.WAV

1	2	3	4
---	---	---	---



**001-00-00**

**POSZ LENGTH ZOOM**

 Locate

 Change setting

## HINT

- You can use the **POSZ** and **LENGTH** soft keys to switch between setting the loop starting point and length.
- You can also play the audio file that you are setting.

 **Start playback**

PLAY

 **Stop playback**

STOP

 **Fast forward**

FF

 **Rewind**

REW

## Zooming in on the waveform

When setting the loop starting point and length, you can zoom in on the waveform that is displayed. Zooming up to 32x is possible.

Press  beneath **ZOOM** to zoom.

**TRACK3** MONO-004.WAV

1	2	3	4
---	---	---	---



**001-01-00**

**POSZ LENGTH ZOOM**

 Change setting





# Playing the pads

For loop tracks and rhythm pattern tracks, press the pad beneath a fader to play the audio file or rhythm pattern assigned to that track.

## 1 Press a pad.



**REPEAT/STOP** Press a pad while holding **REPEAT/STOP** to enable loop playback.

**REPEAT/STOP** Press the pad again while holding **REPEAT/STOP** to stop loop playback.

## Setting the playback method

Set how the pads function when played.

**1 TRACK** Press

**2** Select **PAD** and set the playback method.

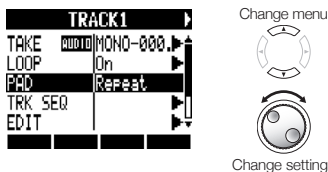

PAD: playback method	
Setting	
Repeat	Play loop repeatedly
Gate	Stop playback as soon as the pad is released
1Shot	Play the file once completely even if the pad is released

## NOTE

- When you press a pad, the sound will be delayed until it is in time with the set quantization (bar, note).
- The pad blinks during playback
- When you stop playback, the operation is delayed until it is in time with the set quantization (bar, note).

## Set global quantization to control sound timing

The unit can be set to correct timing errors when playing the pads or inputting sequence data in real time so that sounds are aligned with bars and beats.

**1 TRACK** Press

**2** Select **TRK SEQ.**



Press

**3** Move to the global quantization area, and change the setting.

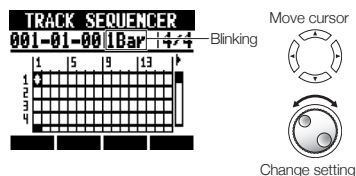

## Global quantization

Global quantization	
Setting	
8Bars, 4Bars, 2Bars, 1Bar (default)	8 bars, 4 bars, 2 bars, 1 bar
1/2, 1/2T, 1/4, 1/4T, 1/8, 1/8T, 1/16, 1/16T, 1/32	Half-note, half-note triplet, quarter-note, quarter-note triplet, eighth-note, eighth-note triplet, sixteenth-note, sixteenth-note triplet, thirty-second note
Hi	1 tick (1/48 of a quarter-note)

## NOTE

- This setting is set for the entire project.



# Changing the BPM of a track

The BPM of each track is automatically calculated when an audio file is assigned to it. Depending on the file, however, the calculated result might differ from the actual BPM.

If this occurs, use the following procedures to adjust the BPM. The set BPM is used as the standard tempo when changing the tempo of the audio without changing its pitch.

- 1** TRACK  Press

- 2** Select the track where you want to change the setting.



Select track



- 3** Select BPM and change the setting.

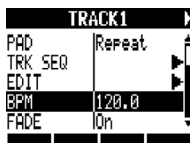

Change menu



Change setting

## NOTE

- BPM is calculated for an audio file assuming 4/4 time.
- When a track is recorded, the current BPM value is used.



# Changing audio tempo without changing pitch

When an audio file is assigned to a track, you can change its tempo without changing its pitch (time-stretching). You can change all tracks at once or individual tracks. Be aware that this operation will overwrite the original audio file.

**1** TRACK

**2** Select a track you want to change (or any track to change all).



**3** Select EDIT.



Press

**4** Select STRETCH.

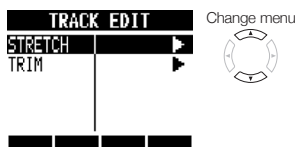

Press

**5** Select MODE and set it to Each to change only the current track or All to change all the tracks.

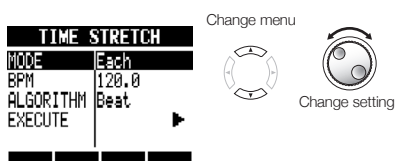

**6** Select BPM and set the new tempo after time-stretching.

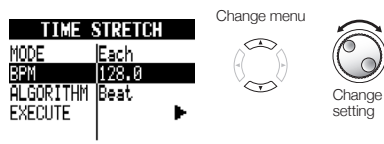

**7** Select ALGORITHM and set it according to the audio file.

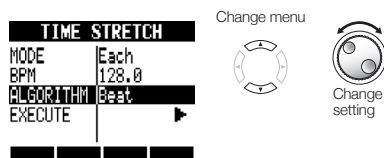

ALGORITHM	
Setting	
Beat	Stretching algorithm suitable for rhythmic sources and other sounds that have short notes
Tone	Stretching algorithm suitable for songs and sound sources with long notes

**8** Select EXECUTE.

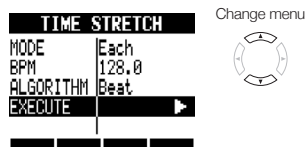

Press

**9** Select YES.

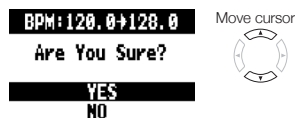

Press

## NOTE

- STRETCH operations cannot be undone (UNDO).
- STRETCH operations overwrite the original audio files. If you want to save the original files, make a copy of the project and files in advance (see P.93).
- The BPM of each track is automatically calculated when an audio file is assigned. Depending on the file material, however, the calculated result might differ from the actual BPM. Set the BPM of each track (TRACK > BPM) if this occurs (see P.67). The set BPM of a track is used as the standard tempo when changing the tempo without changing the pitch of the audio.
- The tempo of an audio file can be adjusted in a range from 50% to 150% of the original. If the stretched tempo value is outside this range, an error message appears, "TRACK X is out of the setting range" (X is the track number) and stretching is stopped.
- If a rhythm pattern has been assigned to a track, the rhythm pattern screen opens after Step 3.

## HINT

- You can listen to a preview of the results of time-stretching for individual tracks.



PLAY

**Press to start playback**

STOP

**Press to stop playback**



# Trimming unnecessary parts of audio files

You can designate the necessary audio data by setting the starting and ending points of a file, and delete the audio data that is outside these points. Be aware that this operation overwrites the original audio file.

- 1 **TRACK** Press
- 2 **Select the track that you want to trim.**



- 3 **Select EDIT.**



Press

- 4 **Select TRIM.**



Press

- 5 **Set the starting point.**

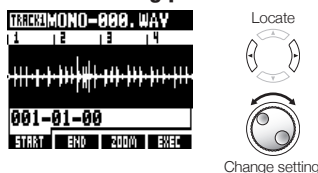

- 6 **Press beneath **END** to set the ending position.**

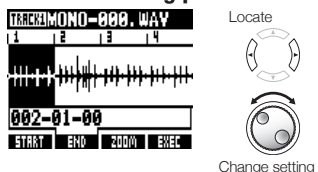

- 7 **Press beneath **EXEC**.**

- 8 **Select YES.**

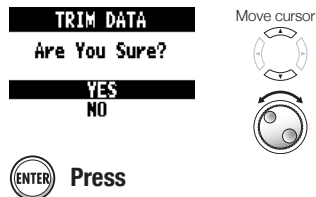

Press

## NOTE

- The TRIM operation cannot be undone (UNDO).
- The TRIM operation overwrites the original file. If you want to save the original files, make a copy of the project and files in advance (see P.93).
- If a rhythm pattern has been assigned to a track, the rhythm pattern screen opens after Step 3.

## HINT

- You can switch between setting the trim starting and ending points by using the START and END soft keys.
- Use the ZOOM soft key to view the waveform more closely.
- You can also play the audio file while setting its starting and ending points.

**Start playback**

PLAY

**Stop playback**

STOP

**Fast forward**

FF

**Rewind**

REW

+ **Return to starting point**

STOP

REW



# Setting fade-ins and fade-outs

When playing normal audio files, there are short fade-ins and fade-outs at their beginnings and ends. You can turn these off, however, for rhythm tracks and other sounds where the attack is important.

- 1** TRACK  Press

- 2** Select a track to change its settings.



- 3** Select FADE and set it to Off if you want to disable it.

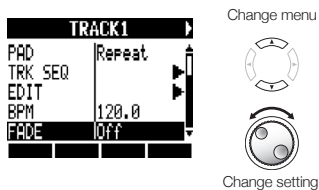

## Track sequencer overview

Using the track sequencer, you can arrange rhythm pattern tracks and loop tracks into performance order to play an entire song.

Each project can have only one set of track sequencer data.

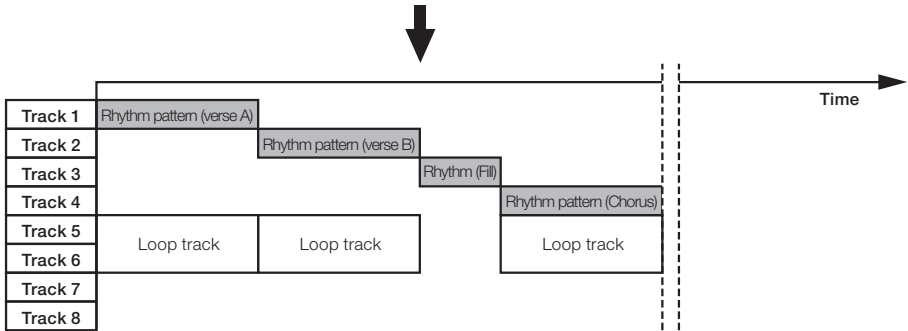
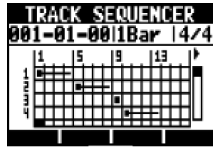

While playing back the track sequencer, you can bounce or record to the master track. You can use this feature when you are running out of tracks to open up some tracks.

When creating a sequence, you can include time signature changes. When the time signature changes, this affects the bars–beats–ticks on the top screen.

In the example shown above, the track sequencer data is played back and bounced in stereo to tracks 7/8, as shown in the illustration below.

After bouncing, a stereo audio file that is a combination of tracks 1–6 is created on tracks 7/8.

Since tracks 1–6 are no longer necessary, they can be used for new parts.

In this example, tracks 1–3 are used for audio tracks to record guitar, bass and vocals. (See “Recording to a new file” on P.27.)

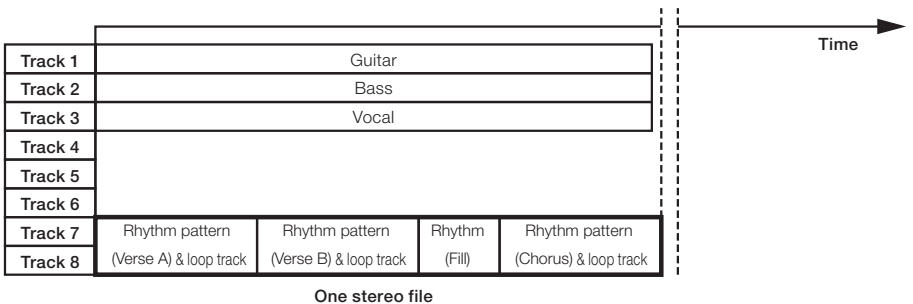



# Creating a sequence

Combine rhythm pattern tracks and loop tracks to create sequence data, including backing parts and rhythms, for an entire track. You can create a sequence with real-time or step input.

## Creating a sequence in real-time

You can create a sequence by playing the pads along with a rhythm (metronome) in real-time.

**1** TRACK  Press

**2** Select TRK SEQ.



Change menu



 Press

**3** Start real-time input by pressing and

holding  and pressing .

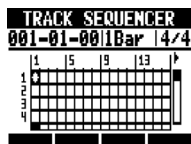

**4** Play the pads in time with the rhythm to input data.



Now Recordings...



**5** To delete input, press and hold  beneath **DELETE**.

Data that has already been input for a track will be deleted while its pad is being pressed.

**6** End input.  Press

STOP

## NOTE

- If your timing playing the pads is slightly off, it will be corrected in accordance with the quantize setting
- You can also be set a metronome pre-count (see P.20).



## Creating a sequence using step input

You can create a sequence one step at a time.

**1 TRACK**  
 Press

**2 Select TRK SEQ.**



Change menu



Press

**3 Start step input.**

Press

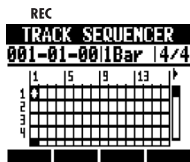

**4 Move the cursor to the position where you want to input or delete data.**

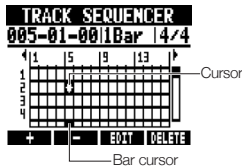

Move cursor



Go back 1 step

Go forward 1 step

Press  beneath  or  to change the length of one step to a bar, beat or 16th note.

**5 To input data, press a pad or ENTER.**

OR

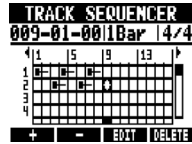

Note-on



Length of loop or rhythm pattern

**6 To delete data at the cursor, press  beneath .**

**7 End input.**

Press  
STOP

### Deleting data

When using step input, you can delete the data before or after the cursor at once.

**1** Move the cursor to the position of the data that you want to delete.

TRACK SEQUENCER  
007-01-001Bar 14/4

1 15 19 13

2

3

4

+ - EXIT DELETE

Move cursor

Go back 1 step

REW

Go forward 1 step

FF

**2** Press  beneath **EXIT**.

**3** Select **DEL EVENT**.

EDIT

INS BEAT

DEL BEAT

DEL EVENT

Change menu

Press

**4** Select **MODE** and set it to **Before** or **After** to delete data to the left or right of the cursor.

DELETE EVENT

MODE Before

EXECUTE

Change menu

Change setting

**5** Select **EXECUTE**.

DELETE EVENT

MODE Before

EXECUTE

Change menu

Press

## Inserting and deleting beats

When using step input for a sequence, you can insert and delete beats. You can even insert and delete a number of beats that differ from the project time signature, changing the time signature for only that part.

### 1 Start step input.

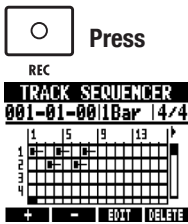

Press 

### 2 Press beneath or to change the length of one step to a bar, beat or 16th note.

### 3 Move the cursor to the position where you want to insert or delete beats.

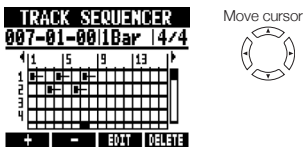

 Go back 1 step

 Go forward 1 step

### 4 Press beneath .

### 5 Select **INS BEAT** to insert beats or **DEL BEAT** to delete beats.



Change menu



 Press

### 6 Select **BEAT** and set the number of beats that you want to insert or delete.



Change menu



Change setting

### 7 Select **SIGNATURE** and set it to **No** to not change the time signature or **Add** to change the time signature.



Change menu



Change setting

### 8 Select **EXECUTE**.



Change menu



 Press

## NOTE

- When you insert beats, the sounds of loops and files playing back will be cut at that point.

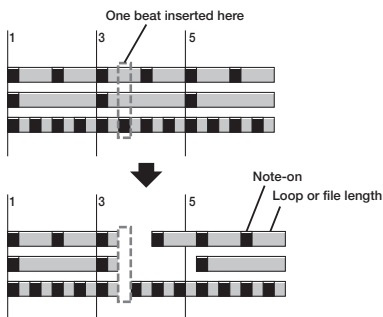

- When you delete beats, the sounds of loops and files playing back at that time will become shorter by the same amount.

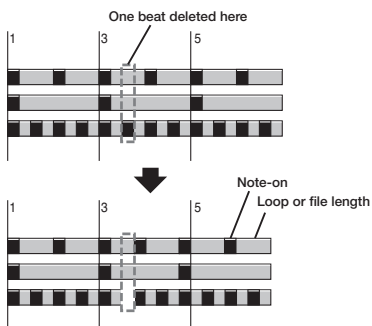

- If you insert or delete beats that differ from the set time signature, the time signature for that part might change depending on the SIGNATURE setting as follows.









SIGNATURE: time signature settings	
Setting	
No	<p>The time signature does not change. The beats are shifted by the amount inserted or deleted.</p> <p>If you insert beats, the time signature of the bar that contains the last inserted beat will change. For example, if 3 beats are inserted into a song with a 4/4 time signature, the bar where the 3rd beat is added will become 7/4.</p> <p>4/4</p> <p>1 2 3 4</p> <p>Three beats inserted here</p> <p>4/4 7/4 4/4</p> <p>1 2 3 4</p>
Add	<p>If you delete beats, the time signature of the bar that they are deleted from will change. For example, if 3 beats are deleted from a song with a 4/4 time signature, that bar will become 5/4.</p> <p>4/4</p> <p>1 2 3 4</p> <p>Three beats deleted here</p> <p>5/4 4/4</p> <p>1 2 3 4</p> <p>The time signature of only 1 bar changes, time signatures of other bars do not change.</p>





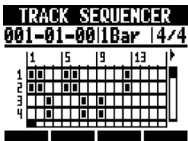



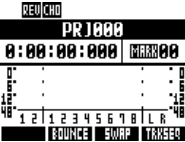

# Playing back a sequence

Use the following procedures to play back the sequence that you made.

## Playback from track sequencer screen

- 1 **TRACK**  
 Press
- 2 **Select TRK SEQ.**  
  **Change menu**  
 Press
- 3  Press  
  
 Press to stop playback  
 and press  to return to the beginning.

## Playback from the Top Screen

- 1 Press  beneath **TRACKED** to turn the track sequencer ON/OFF.  

- 2  Press  
  
Track sequencer ON  
 Press to stop playback  
 Press to fast forward  
 Press to rewind  
 and press  to return to the beginning.



# Overview of effects

The **RB** has two types of built-in effects: insert effects and send-return effects. These can be used at the same time.

Effects can only be used when the project sampling rate is 44.1 kHz.

## Insert effects

The **RB** has a variety of insert effects that are useful when recording, including for guitar, bass and mastering. Insert effects are applied to specific signal paths.

Insert effects can be placed in the following places according to the application.

### 1. Input (enabled inputs)

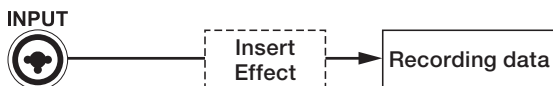

### 2. Track (enabled tracks)

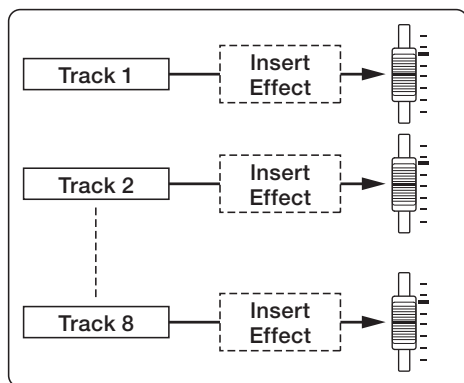

### 3. Master (just before the MASTER fader)

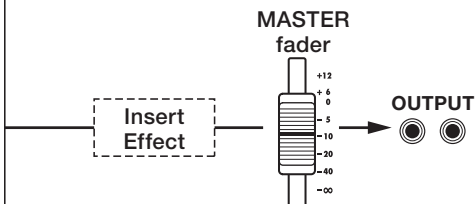

1. Input: Inserted after the input, you can record the input signal with the effect.  
(See “Applying insert effects” on P.23.)
2. Track: Inserted on a track, you can hear the effect during playback of that audio track.  
(See “Using the insert effects on tracks” on P.45.)
3. Master: Inserted just before the MASTER fader, you can apply the effect when mixing down (recording a final stereo mix to the master track).  
(See “Using a mastering effect” on P.46.)

## Algorithms and patches

Insert effects are arranged in groups called “algorithms” according to the instrument or application. An algorithm is a linear series of a variety of effect modules, such as compression, distortion and delay.

An effect module consists of two elements—the effect type and its parameters.

A “patch” is the saved combination of the effect types and parameters of each module.

Algorithm name	Display name	Number of patches (preprogrammed)
▼ Clean and crunchy sounds that are suitable for guitars		
Clean/Crunch	Clean	30 (21)
▼ Overdrive and other distorted sounds suitable for guitars		
Distortion	Distortion	50 (45)
▼ Instrument simulation algorithm that is suitable for guitars		
Aco/Bass SIM	Aco/Bass	20 (10)
▼ Algorithm that is suitable for recording bass guitars		
Bass	Bass	30 (20)
▼ Algorithm that is suitable for vocals and other mic recordings		
Mic	Mic	50 (30)
▼ Algorithm for two completely independent mic channels		
Dual Mic	Dual Mic	50 (30)
▼ Algorithm for synths, built-in mics and other stereo recording		
Stereo	Stereo	50 (40)
▼ Algorithm for processing final stereo mix signals		
Mastering	Mastering	30 (21)

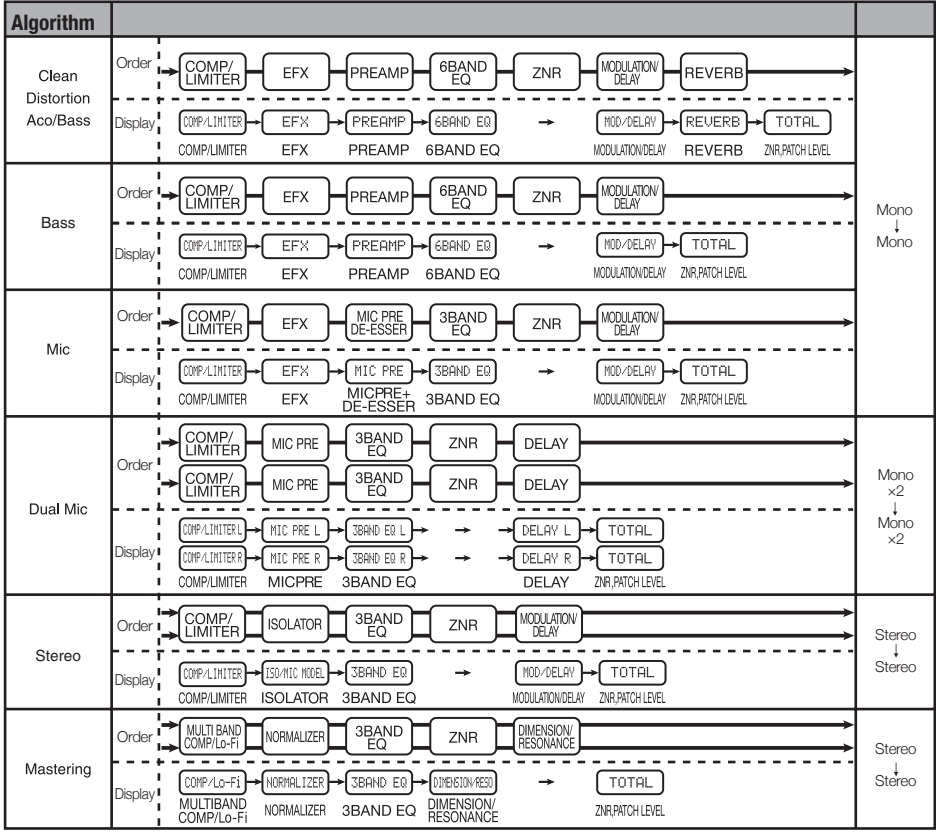
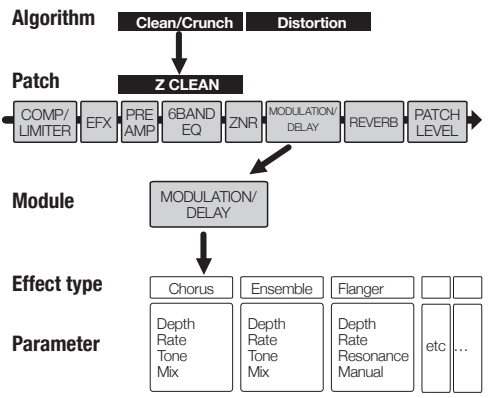



## Send-return effects

Send-return effects are connected internally to the track mixer send/return bus. The depth of the send-return effects can be adjusted with the track send levels (amounts of signal sent to the effect). When you raise a track's send level from 0, its signal is sent (input) to the send-return effect. The signal passes through the effect and is returned (routed) to before the MASTER fader, and mixed with the original sound of that track.

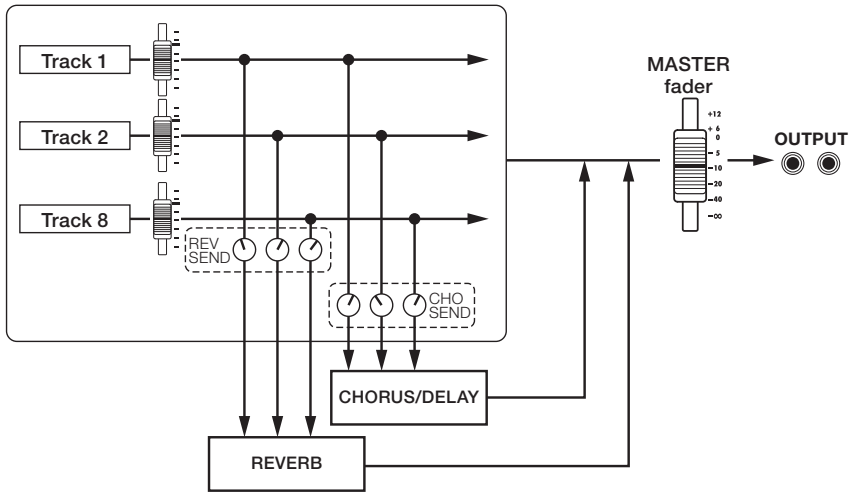

Algorithm (Display name)	Number of patches (already programmed patches)
REVERB (SEND REVERB)	30 (22)
CHORUS/DELAY (SEND CHORUS/DELAY)	30 (18)



# Selecting effect patches

Select the effect patch that you want to use. For the insert effect, choose an algorithm that is suitable for the instrument or application.

## 1 EFFECT

Press

### Accessing the effect settings

Press  beneath **INSERT** to select an insert effect.

Press  beneath **REVERB** to select a reverb send-return effect.

Press  beneath **CHORUS** to select a chorus/delay send-return effect.

## 2 Select ON/OFF and set it to ON.



Change menu



Change setting

## 3 Select an algorithm (when setting an insert effect).



Change menu



Change algorithm

## 4 Select a patch.

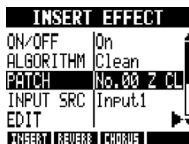

Change menu



Change patch



# Editing patches

You can change effect types and adjust effect parameters to create your own patches.

**1** **EFFECT** **Press**

**Accessing the effect settings**

Press beneath **INSERT** to select an insert effect.

Press beneath **REVERB** to select a reverb send-return effect.

Press beneath **CHORUS** to select a chorus/delay send-return effect.

**2** **Select ON/OFF and set it to On.**

**INSERT EFFECT**

ON/OFF	On
ALGORITHM	Clean
PATCH	No.00 Z CL
INPUT SRC	Input1
EDIT	

**INSERT REVERB CHORUS**

Change menu

Change setting

**3** **Select an algorithm and patch.**

**INSERT EFFECT**

ON/OFF	On
ALGORITHM	Clean
PATCH	No.00 Z CL
INPUT SRC	Input1
EDIT	

**INSERT REVERB CHORUS**

Change menu

Change setting

**4** **Select EDIT.**

**INSERT EFFECT**

ON/OFF	On
ALGORITHM	Clean
PATCH	No.00 Z CL
INPUT SRC	Input1
EDIT	

**INSERT REVERB CHORUS**

**Press**

**5** **Editing effect modules**

**Turn the effect type On to edit it.**

Effect module (TYPE) Off

**COMP/LIMITER** **Press ENTER or the ON/OFF soft key to turn the module on or off.**

TYPE Off

ON/OFF

Effect module (TYPE) on

**COMP/LIMITER** **Effect type**

TYPE	Compressor
Sense	1
Attack	Fast
Tone	8
Level	80

ON/OFF

E: Edit mark shown when a patch has been edited or changed

**6** **Selecting effect modules**

**Select the effect module.**

**COMP/LIMITER** **Change module**

TYPE	Compressor
Sense	1
Attack	Fast
Tone	8
Level	80

ON/OFF

**MOD/DELAY** **Change module**

TYPE	Exciter
Frequency	1
Depth	16
Low Boost	0

ON/OFF

**Adjust the patch level (final patch volume)**

**7** **Select the TOTAL effect module.** **Change module**

**8** **Select PATCH LVL and set the value.** **Change menu**

**TOTAL** **Change value**

PATCH LVL	25
ZNR	Off

**9** **Return to the main effect screen.** **Press**

**Adjusting effect parameters**

**1** **Select a parameter and set it.**

**MOD/DELAY** **Select parameter**

TYPE	Exciter
Frequency	1
Depth	16
Low Boost	0

ON/OFF

**Change value**

## HINTS

- In “Empty” patches none of the modules have been set yet.
- Adjust the ZNR module level on the TOTAL module screen.
- With the DUAL MIC ALGORITHM, you can edit the modules in the left and right channels separately. The left channel is selected when “L” appears in the effect module name and the right channel is selected when “R” appears.

## NOTE

- You cannot edit algorithms themselves, including their combinations and arrangements of effect modules.
- When you turn an effect module OFF, all its settings, including the type and parameters are disabled.
- If you switch to another patch without saving a patch that has been edited (showing the ‘E’ mark), changes will be lost. For information about how to save patches, see “Saving patches” on P.86.

# Saving patches

You can save a patch at any patch number within the same algorithm. You can also copy an existing patch to a different location.



- 1 Accessing the effect settings**

Press **ENTER** beneath **INSERT** to select an insert effect.

Press **ENTER** beneath **REVERSE** to select a reverb send-return effect.

Press **ENTER** beneath **CHORUS** to select a chorus/delay send-return effect.
- 2 Select the algorithm/patch.**

Change menu

```

INSERT EFFECT
ON/OFF On
ALGORITHM Clean
PATCH No.00 Z CL
INPUT SRC Input1
EDIT
INSERT REVERSE CHORUS
            
```

Change setting
- 3 Select SAVE.**

Change menu

```

INSERT EFFECT
ALGORITHM Clean
PATCH No.00 Z CL
INPUT SRC Input1
EDIT
SAVE
INSERT REVERSE CHORUS
            
```

Press
- 4 Select SAVE TO.**

Change menu

```

EFFECT PATCH SAVE
SAVE TO No.00:Z CL
EXECUTE
            
```

Press
- 5 Select where to save it.**

Patch number and name where it will be saved

```

PATCH SAVE TO
No.00:Z CLEAN
No.01:Z CHORUS
No.02:FdClean
No.03:UxCrunch
No.04:TWEED
            
```

Set save location

Press

See next page to import a patch

- 6 Select EXECUTE.**

Change menu

```

EFFECT PATCH SAVE
SAVE TO No.00:Z CL
EXECUTE
            
```

Press

- NOTE**
- These procedures are the same for both insert and send-return effects.
  - If you switch to another patch without saving a patch that has been edited (showing the 'E' mark), changes will be lost. Always save patches.
  - The import source and the import destination are different projects when using PATCH IMPORT.

# Importing patches from other projects

You can import one or all patches that have been created in another project for use in the current project.



- 3 Select IMPORT.**

Change menu

```

INSERT EFFECT
INPUT SRC Input1
EDIT
SAVE
RENAME
IMPORT
INSERT REVERSE CHORUS
            
```

Press
- 4 Select MODE and set it to All or Each.**

Change menu

```

PATCH IMPORT
MODE Each
PROJECT PRJ001
NEXT
            
```

Change setting

All	Import all patches from the source project
Each	Select and import one patch from the source

**Import all patches**  
IMPORT > All

- 1 Select PROJECT.**

Change menu

```

PATCH IMPORT
MODE All
PROJECT PRJ001
NEXT
            
```

Press
- 2 Select the project to import from.**

Import source project name

Select project

```

PROJECT SELECT
PRJ001
PRJ002
PRJ003
PRJ004
PRJ005
            
```

Press
- 3 Select NEXT.**

Change menu

```

PATCH IMPORT
MODE All
PROJECT PRJ001
NEXT
            
```

Press
- 4 Select YES.**

Move cursor

```

PATCH IMPORT
Are You Sure?
YES
NO
            
```

Press

**Import one patch**  
IMPORT > Each

- 1 Select PROJECT.**

Change menu

```

PATCH IMPORT
MODE Each
PROJECT PRJ001
NEXT
            
```

Press
- 2 Select the project to import from.**

Import source project name

Select project

```

PROJECT SELECT
PRJ001
PRJ002
PRJ003
PRJ004
PRJ005
            
```

Press
- 3 Select NEXT.**

Change menu

```

PATCH IMPORT
MODE Each
PROJECT PRJ001
NEXT
            
```

Press
- 4 Select the patch to import.**

Import source patch number and name

Change patch

```

PATCH IMPORT FROM
No.00 Z CLEAN
No.01 Z CHORUS
No.02 FdClean
No.03 UxCrunch
No.04 TWEED
            
```

Press
- 5 Select the destination patch.**

Import destination patch number and name

Change patch

```

PATCH IMPORT TO
No.00 Z CLEAN
No.01 Z CHORUS
No.02 FdClean
No.03 UxCrunch
No.04 TWEED
            
```

Press
- 6 Select YES.**

Move cursor

```

PATCH IMPORT
Are You Sure?
YES
NO
            
```

Press



# Changing patch names

You can change the name of the patch that is currently selected.

## Changing patch names

Change the name of the current patch.

**1** **EFFECT**  
 Press

### Accessing the effect settings

Press  beneath **INSERT** to select an insert effect.

Press  beneath **REVERB** to select a reverb send-return effect.

Press  beneath **CHORUS** to select a chorus/delay send-return effect.

**2** Select **ON/OFF** and set it to **On**.

INSERT EFFECT	
ON/OFF	On
ALGORITHM	Clean
PATCH	No.00 Z CL
INPUT SRC	Input1
EDIT	
REVERB	REVERB
CHORUS	CHORUS

Change menu



Change setting

**3** Select the algorithm and patch.

INSERT EFFECT	
ON/OFF	On
ALGORITHM	Clean
PATCH	No.00 Z CL
INPUT SRC	Input1
EDIT	
REVERB	REVERB
CHORUS	CHORUS

Change menu



Change setting

**4** Select **RENAME**.

INSERT EFFECT	
PATCH	No.00 Z CL
INPUT SRC	Input1
EDIT	
SAVE	
RENAME	
REVERB	REVERB
CHORUS	CHORUS

 Press

**5** Change the name.

**PATCH RENAME**

**Z CLEAN**

 ENTER  CANCEL EXIT

 DELETE  INSERT

 Press

Change menu



Move cursor



Change character



Delete character



Insert character



# Using effects only for monitoring

When an insert effect is applied to an input, usually the sound with the effect applied is recorded to the track. By applying an insert effect only to monitoring, input signals can be recorded without effects to tracks.

For example, you can record vocals without an effect, but use a mic insert effect on the monitoring signal to make it easier for the vocalist to sing.

## 1 EFFECT Press



### Accessing the effect settings

Press  beneath **INSERT** to select an insert effect.

## 2 Select the algorithm and patch.



Change menu



Change setting

## 3 Select REC SIG and make the setting.



Change menu



Change setting

Wet	Input signals are recorded to tracks after being processed by the insert effect. (Default)
Dry	Input signals are recorded to tracks before being processed by the insert effect. The input signal monitored from the <b>OUTPUT</b> and <b>PHONES</b> jacks, however, is processed by the insert effect.

## HINT

- The settings made here are stored for each project separately.
- If necessary, reset to **Wet** before recording other parts.

## Projects and audio files

The **RS** manages the data and settings that are necessary to play back songs that you have created in units called “projects.” Track audio recordings are saved as WAV files.

### Data saved in a project

- Audio data for every track including the master
- Mixer settings
- Effect settings
- Mark information
- Metronome settings
- Tuner settings
- Sampler settings
- Rhythm settings
- Track sequencer settings
- Recorder settings

### Projects on the SD cards

When a project is created, a folder with the same name is created inside the PROJECT folder on the SD card.

All the data for that project is saved inside that folder. The audio data for that project is saved in the AUDIO subfolder inside that project's folder.

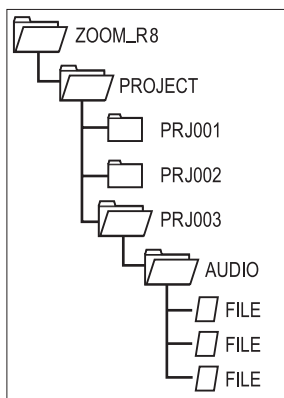



# Protecting and selecting projects

## Protecting a project

PROJECT &gt; PROTECT

You can protect the currently loaded project to prevent it from being saved or deleted so that its contents cannot be changed.

1 PROJECT  Press

2 Select PROTECT.



Change menu



3 Select On.



Change

## NOTE

- When a project is protected, you cannot record in it or edit it, and any changes will not be saved to the SD card. Set PROTECT to Off if you want to record in it or edit it again.
- Projects that are not protected will be automatically saved to the SD card when you turn the **POWER** switch OFF or load another project.
- We recommend setting PROTECT to On once you complete a piece of music to avoid mistakenly saving unwanted changes later.

## HINT

- This icon appears when a project is protected.



## Selecting a project

PROJECT &gt; SELECT

Load a project saved on the SD card.

1 PROJECT  Press

2 Select SELECT.

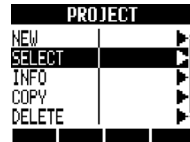

Change menu



ENTER Press

3 Select the project.

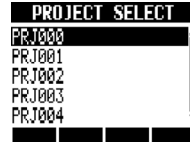

Change project

ENTER Press

## NOTE

- You can only playback and record to the project that is currently loaded. You cannot use multiple projects at the same time.

## HINT

- When you turn the **RS** power ON, the project loaded the last time the unit was used will be loaded automatically.





# Viewing project and audio file information

You can display information about the currently loaded project and audio files, including their names, creation dates, sizes and recording times.

## Project information

PROJECT > INFO

Follow these procedures after opening the project with the information you want to see.

1 **PROJECT**  
 Press

2 **Select INFO.**

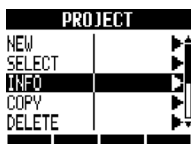

Change menu



Press

3 **Check the information.**

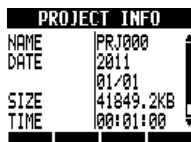

Scroll



PROJECT INFO: project information	
NAME	Project name
DATE	Year/month/date of creation
SIZE	Card capacity used
TIME	Recording time
RATE	Sampling rate

## HINT

- Project and file information can only be viewed on the PROJECT INFO screen. It cannot be edited.

## Audio file information

PROJECT > FILE > INFO

1 **PROJECT**  
 Press

2 **Select FILE.**

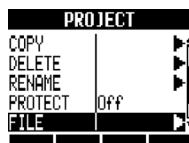

Change menu



Press

3 **Select the file.**

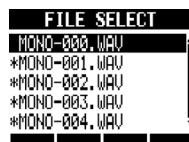

Change file

Press

4 **Select INFO.**

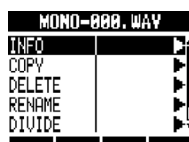

Change menu



Press

5 **Check the information.**

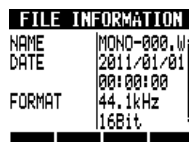

Scroll



FILE INFORMATION	
NAME	File name
DATE	Year/month/date of creation
FORMAT	File format
SIZE	File size
TIME	Length of recording



# Copying projects and audio files

You can copy a saved project as a new project.

An audio file can be copied within a project after changing the file name.

## Copying a project

PROJECT > COPY

Follow these procedures after opening the project that you want to copy.

- 1 PROJECT**  
Press **Press**
- 2 Select COPY.**  
 **Change menu**  
 **Press**
- 3 Select NAME.**  
 **Change menu**  
 **Press**
- 4 Change the project name.**  
 **Move cursor**  
 **DELETE** Delete character  
 **INSERT** Insert character  
 **Change character**  
 **Press**
- 5 Select EXECUTE.**  
 **Press**

## NOTE

- You cannot make a copy without changing the name to something different from the original.

## Copying an audio file

PROJECT > FILE > COPY

- 1 PROJECT**  
Press **Press**
- 2 Select FILE.**  
 **Change menu**  
 **Press**
- 3 Select the file to copy.**  
 **Change file**  
 **Press**
- 4 Select COPY.**  
 **Change menu**  
 **Press**
- 5 Select NAME.**  
 **Change menu**  
 **Press**
- 6 Change the file name.**  
 **Move cursor**  
 **DELETE** Delete character  
 **INSERT** Insert character  
 **Change character**  
 **Press**
- 7 Select EXECUTE.**  
 **Press**



# Changing project and audio file names

You can change the names of the currently loaded project and audio files.

## Changing a project name

PROJECT > RENAME

Open the project that you want to change the name of and follow these procedures.

**1** **PROJECT**  
 Press

**2** **Select RENAME.**

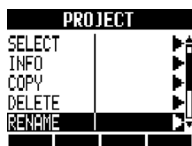

 Press

**3** **Change the characters.**

**NEW PROJECT NAME**

Move cursor

**DELETE**

Delete character

**INSERT**

Insert character

PRJ003

 ENTER  EXIT

 Press



## NOTE

- You cannot change the name to the same name as that of another project.
- The project name is also given to the corresponding project folder in the ZOOM\_R8/PROJECT folder on the SD card.

## HINT

- Project names
  - Max. number of characters: 8
  - Alphabet: A-Z (uppercase)
  - Symbols: \_ (underscore)
  - Numerals: 0-9
- File names
  - Max. number of characters: 219 (not incl. extension)
  - Alphabet: A-Z, a-z
  - Symbols: (space) ! # \$ % & ' ( ) + , - ; = @ [ ] ^ \_ ` { } ~
  - Numerals: 0-9

## Changing an audio file name

PROJECT > FILE > RENAME

**1** **PROJECT**  
 Press

**2** **Select FILE.**

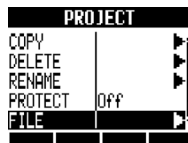

Change menu



 Press

**3** **Select the file name.**

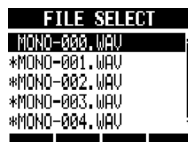

Change file

 Press

**4** **Select RENAME.**

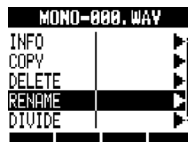

Change menu



 Press

**5** **Change the characters.**

**FILE RENAME**

Move cursor

**DELETE**

Delete character

**INSERT**

Insert character

MONO-000

 ENTER  EXIT

 Press

Change character





# Deleting projects and audio files

You can delete a selected project or file.

## Deleting a project

PROJECT > DELETE

- 1** **PROJECT**  **Press**
- 2** **Select DELETE.**

PROJECT	
NEW	
SELECT	
INFO	
COPY	
DELETE	
RENAME	
PROTECT	Off
FILE	

 **Change menu**

 **Press**
- 3** **Select the project to delete.**

PROJECT DELETE	
PRJ002	
PRJ003	
PRJ004	
PRJ005	
PRJ006	

 **Change project**

 **Press**
- 4** **Select YES.**

DELETE:PRJ003	
Are You Sure?	
YES	
NO	

 **Move cursor**

 **Press**

## NOTE

- Once a project or file is deleted, it cannot be recovered. Please delete with care.
- If PROTECT is On for a project, that project and its files cannot be deleted.

## Deleting an audio file

PROJECT > FILE > DELETE

- 1** **PROJECT**  **Press**
- 2** **Select FILE.**

PROJECT	
COPY	
DELETE	
RENAME	
PROTECT	Off
FILE	

 **Change menu**

 **Press**
- 3** **Select the file name.**

FILE SELECT	
MONO-000.WAV	
*MONO-001.WAV	
*MONO-002.WAV	
*MONO-003.WAV	
*MONO-004.WAV	

 **Change file**

 **Press**
- 4** **Select DELETE.**

MONO-000.WAV	
INFO	
COPY	
DELETE	
RENAME	
DIVIDE	

 **Change menu**

 **Press**
- 5** **Select YES.**

DELETE:MONO-000.WA	
Are You Sure?	
YES	
NO	

 **Move cursor**

 **Press**



# Dividing audio files

You can divide an audio file at any point to make two files.

Do this to delete unnecessary portions of recordings or to divide long recordings.

**1** **PROJECT**  **Press**

**2** **Select FILE.**

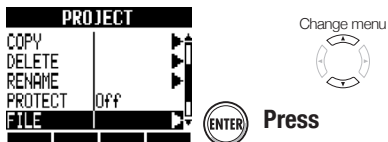

**3** **Select the file.**

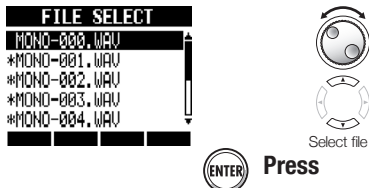

**4** **Select DIVIDE.**

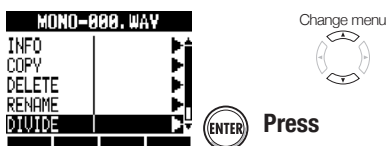

**5** **Set the division point.**

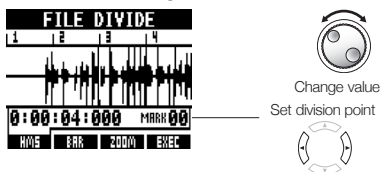







**6** **Press  beneath EXEC.**

**7** **Select YES.**



You can use the following keys to listen to a file and to set the division point.

 PLAY	Press to start playback
 STOP	Press to stop playback
 FF	Press to fast forward
 REW	Press to rewind
 STOP + REW	Press together to return to the beginning of the file
	Use the mark keys to move to marks

## HINT

- When a file is divided, files with new names will be created automatically in the same folder. "A" is added to the end of the name of the file of the part before the dividing point. "B" is added to the end of the name of the file of the part after the dividing point.
- The original divided file is deleted.

 Reference:  
Locating to the desired part of a song

P.36



# Setting the recording format and mode

## Setting the recording format (bit length)

PROJECT &gt; REC &gt; BIT LEN

You can record at 16-bit, which is ordinary CD quality, or higher-quality 24-bit format.

**1** PROJECT  
 Press

**2** Select REC. Change menu



 Press

**3** Select BIT LEN. Change menu



**4** Set the bit length.



16-bit/24-bit

## HINT

- When overwriting, recording will be at the bit rate of the original file. For example, you cannot overwrite a file recorded at 16-bit with a 24-bit file.
- Settings are stored separately for each project.
- The default value is 16bit.
- If you record at 44.1kHz/24bit, 48kHz/16bit or 48kHz/24bit formats, you will have to convert files to 44.1kHz/16bit to create an audio CD.

## Setting the recording mode

PROJECT &gt; REC &gt; REC MODE

When recording, you can either overwrite the previous recording or keep it and create a new recording.

This is convenient for recording band performances and drums, for example, when you want to record multiple takes.

**1** PROJECT  
 Press

**2** Select REC. Change menu

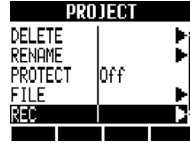

 Press

**3** Select REC MODE. Change menu



**4** Set the recording mode.



Change setting

REC MODE: recording mode	
Setting	
Overwrite	Previous recordings are overwritten (default)
Always New	Previous recordings are always saved and new recordings are always made



# Sequential playback of projects

The playback order of multiple projects can be registered and managed in playlists. Use these to play songs consecutively, for live performance accompaniment and when outputting to an external recorder, for example.

## Playing back a playlist

PROJECT > SEQ PLAY > PLAY

- 1 PROJECT**  
Press
  - 2 Select SEQ PLAY.**  
Change menu  
Press
  - 3 Select the playlist.**  
SEQUENCE PLAY LIST  
List1:2Songs  
List2:1Song  
List3:2Songs  
List4:Empty  
List5:Empty  
Number of projects in list  
Select list  
"Empty" shown when no songs in list  
Press
  - 4 Select PLAY.**  
Change menu  
Press
- Screen appearance during playback
- TR001:PRJ002 — Playlist number  
0:00:06:708 — Project name  
— Elapsed playback time
- Playback (track) number  
Playback stops at the end of the last project.

## HINT

### Key operation during playback

	Play from the beginning of the current project
	Stop playback and return to the beginning of the current project
	Play from the beginning of the first project (TR001)
	Stop playback and start playback from the beginning of the next project
	Stop playback and start playback from the beginning of the previous project

## Editing playlists

PROJECT > SEQ PLAY > EDIT

- 4 Select EDIT.**  
Change menu  
Press
- 5 Register projects or edit a playlist**  
Select the first project (or the project to change).  
Change tracks  
End of list indication  
Change project
- 6 Register project to be played.**  
Change project
- 7 Select and register more projects.**  
Change tracks  
Change project
- 8 Press to return to the previous menu.**  
EXIT

## Remove a project from a list

## 5 Select a project to remove.

```
EDIT>List4
1 PRJ002
2 PRJ001
3 End of List
```

Change tracks



```
DELETE:INBERT
```

6 Press  beneath **DELETE**.

```
EDIT>List4
1 PRJ002
2 End of List
```

```
DELETE:INBERT
```

## Insert a project into a list

## 5 Select the track number to insert to.

```
EDIT>List4
1 PRJ002
2 End of List
```

Change tracks



```
DELETE:INBERT
```

6 Press  beneath **INBERT**.

```
EDIT>List4
1 PRJ002
2 PRJ002
3 End of List
```

```
DELETE:INBERT
```

This inserts the currently selected project

## Delete a playlist

PROJECT &gt; SEQ PLAY &gt; DELETE

Follow steps 1–3 in "Playing back a playlist" on the previous page to select a playlist and then delete it as follows.

4 Select **DELETE**.

```
List4:2Songs
EDIT
DELETE
PLAY
```

Change menu



```
ENTER
```

Press

5 Select **YES**.

```
DELETE>List4
Are You Sure?
YES
NO
```

Move cursor



```
ENTER
```

Press

## NOTE

- If the master track or the file assigned to the master track is deleted, the playlist will become empty.
- Assign the recordings that you want to hear to the master tracks of the projects that you register in a playlist.
- To change the file of a registered project, set its master track and edit the playlist.
- The maximum number of playlists is 10. Each playlist can have a maximum of 99 projects.
- A project cannot be registered if its master track is not set or its file is less than 4 seconds long.



Reference:  
Mixing down to the master track

P.47





# Loading audio files from other projects

You can copy audio files from other projects saved on the SD card and import them into the current project.

- 1** **TRACK** **Press**
- 2** **Select the track that you want to assign the file to.**

**TRACK1**

TAKE **AUDIO** New Take ▶

LOOP

PAD

TRK SEQ

EDIT

Select track

**ENTER** **Press**
- 3** **Select TAKE.**

**TRACK1**

TAKE **AUDIO** New Take ▶

LOOP

PAD

TRK SEQ

EDIT

Change menu

**ENTER** **Press**
- 4** **Select OTHER PRJ.**

**TAKE SELECT**

FILE

PATTERN

LOOP

OTHER PRJ ▶

Change menu

**ENTER** **Press**
- 5** **Select PROJECT.**

**FILE IMPORT**

PROJECT | PRJ001 ▶

EXT

Change menu

**ENTER** **Press**
- 6** **Select the project that contains the file you want to load.**

**PROJECT SELECT**

RJ001

RJ002

Select project

**ENTER** **Press**
- 7** **Select NEXT.**

**FILE IMPORT**

PROJECT | PRJ001 ▶

NEXT ▶

Change menu

**ENTER** **Press**
- 8** **Select the file that you want to load.**

**FILE SELECT**

MONO-000.WAV

MONO-001.WAV

Select file

**ENTER** **Press**
- 9** **Change the file name.**

**FILE RENAME**

MONO-000

OK ENTER CANCEL EXIT

DELETE INSERT

Move cursor

DELETE Delete character

INSERT Insert character

Change character

**ENTER** **Press**
- 10** **Select YES.**

**IMPORT: MONO-003.WAV**

Are You Sure?

YES

NO

Move cursor

**ENTER** **Press**

## HINT

- Projects with sampling rates that differ from the current project will not be shown. If there are no projects with the same sampling rate, "No Project" will be shown.



## USB function overview

The **R8** has a USB jack (mini-B type) on its right side.

In addition to connecting the included USB adapter to an electrical outlet to power the **R8**, you can also connect it with a computer and use it as a card reader, audio interface and control surface.

### Card reader

You can access the SD card in the **R8** using a computer to backup and restore projects.

In addition, audio data on the **R8** can be saved on a computer, and WAV files on a computer can be loaded to the **R8**.

### Audio interface

The **R8** can be used as an interface between a computer and instruments and other audio equipment

You can also connect high impedance instruments and microphones that require phantom power when used as an audio interface.

### Control surface

You can use the **R8** to control DAW software. Use its faders and keys to control transport and mixer operations in your DAW software.

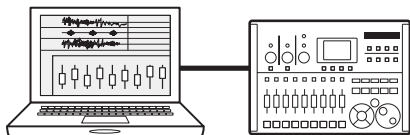

## NOTE

- To import an audio file into the **R8**, its format must be WAV with a sampling rate of 44.1 or 48 kHz and a bit rate of 16 or 24.
- To use a WAV file in a project, it must use the sampling rate as set for the project when it was created (RATE).
- File names can have up to 219 characters (not including the extension). The following characters are allowed  
Alphabet: A-Z, a-z  
Numerals: 0-9  
Symbols: (space) ! # \$ % & ' ( ) + , - ; = @ [ ] ^ \_ ` { } ~
- If the name of an imported file includes double-byte characters, its file name will be shown with "R8\_" as a prefix in this format: "R8\_xxxxx.WAV".
- You can connect the **R8** with a computer by USB when either has its power ON.
- When using the **R8** as a card reader or as an audio interface, it cannot be used as a recorder at the same time.

## HINT

- Card reader OS compatibility  
Windows: Windows XP and later  
Macintosh: Mac OS x 10.5 and later
- Project data is saved to the corresponding PROJECT folder in the ZOOM\_R8 folder on the SD card. Folders are created and managed for each project.
- Audio data is saved as WAV files inside the AUDIO folder of its project folder.
- The "PRJINFO.TXT" file inside each AUDIO folder shows the names of files assigned to tracks.
- MASTER tracks and stereo tracks are stereo WAV files.

## Exchanging data with a computer (card reader)



You can access the **RB** SD card using a computer to backup and restore projects and audio files and import audio data created in DAW software, for example.

### Backing up a project on a computer

**RB** project data is saved in project folders on the SD card. To backup a project, copy its project folder to the computer hard disk.

The folders on the SD card are organized as follows:

```

"ZOOM_RB" folder
  > "PROJECT" folder
      > (Project) folder*
  
```

\*Project folders have the same names as their projects.

### Restoring a project from its backup

To restore a project that has been backed up on a computer, copy its project folder from the computer to the "PROJECT" folder on the SD card in the **RB**.

The folders on the SD card are organized as follows:

```

"ZOOM_RB" folder
  > "PROJECT" folder
      > (Project) folder*
  
```

\*Project folders have the same names as their projects.

### Saving audio data from the **RB** to a computer

Audio recordings on the **RB** are stored as WAV files in "AUDIO" folders on the SD card.

The folders on the SD card are organized as follows:

```

"ZOOM_RB" folder
  > "PROJECT" folder
      > (Project) folder*
          "AUDIO" folder
  
```

\*Project folders have the same names as their projects.

To copy WAV files to the computer, copy the WAV files in the "AUDIO" folder to the computer hard disk.

The "PRJINFO.TXT" file inside each "AUDIO" folder shows the names of files assigned to tracks.

### Copying WAV files from a computer to the **RB**

To copy WAV files from a connected computer to the **RB**, copy the WAV files to an "AUDIO" folder on the SD card.

The folders on the SD card are organized as follows:

```

"ZOOM_RB" folder
  > "PROJECT" folder
      > (Project) folder*
          "AUDIO" folder
  
```

\*Project folders have the same names as their projects.

To play back these WAV files on the **RB**, select that project and assign the copied WAV files to tracks.

(See "Changing the playback take" on P.30.)

## Using the card reader function

USB &gt; READER

1 Connect the **RS** and computer with the USB cable and turn the power on.

2  Press

3 Select **READER**.

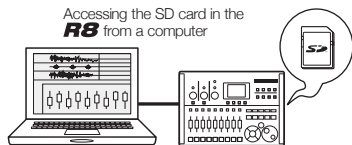
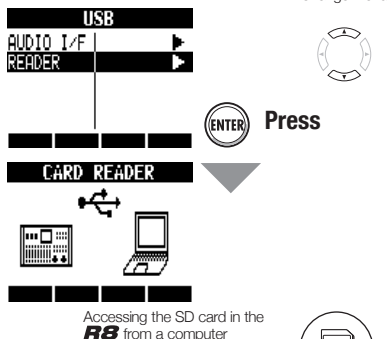

## HINT

- To import WAV files from a computer, copy them to the "AUDIO" folder in the project folder where you want to use them. Use the **RS** to assign the files to tracks.

## Disconnecting

1 Eject the **RS** volume icon from your computer to end the connection.

2 Press  or  to disconnect.

3 Select **YES**.

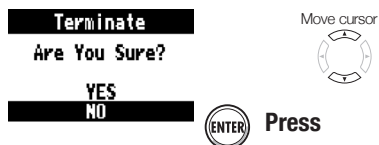

## NOTE

- To import an audio file into the **RS**, its format must be WAV with a sampling rate of 44.1 or 48 kHz and a bit rate of 16 or 24.
- To use a WAV file in a project, it must use the sampling rate that was set for the project when it was created (RATE).
- File names can have up to 219 characters (not including the extension). The following characters are allowed.  
 Alphabet: A-Z, a-z  
 Numerals: 0-9  
 Symbols: (space) ! # \$ % & ' ( ) + , - ; = @ [ ] ^ \_ ` { } ~
- If the name of an imported file includes double-byte characters, its file name will be shown with "R8\_" as a prefix in this format: "R8\_XXXXXX.WAV".

## HINT

- Card reader OS compatibility  
 Windows: Windows XP and later  
 Macintosh: Mac OS x 10.5 and later
- The "PRJINFO.TXT" file inside each AUDIO folder shows the names of files assigned to tracks.
- MASTER tracks and stereo tracks are stereo WAV files.



# Audio interface and control surface functions

Connect the **R8** to a computer to use it to input and output sound and as a controller for DAW software.

## Connecting as an audio interface or control surface

### 1 Audio interface

The **R8** can be used as an interface between a computer and instruments and other audio equipment, allowing audio to be recorded in DAW software, for example. You can even connect high-impedance instruments and microphones that require phantom power.

### 2 Control surface

You can use the faders and keys on the **R8** to control transport and mixer operations in computer DAW software.

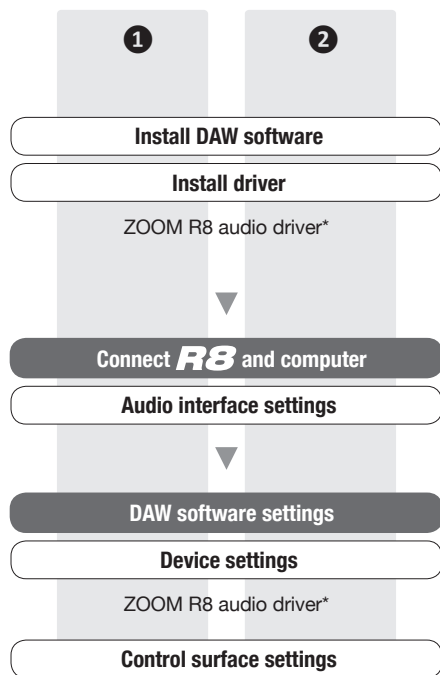

\*No driver is necessary for use with a Macintosh

## Connecting the **R8** to a computer for the first time

### 1 Install the ZOOM R8 Audio Driver on the computer.

(No driver is necessary for use with a Macintosh.)

Reference: Cubase LE5 Startup Guide

### 2 Connect the **R8** to the computer.

#### Set and connect the **R8**

(See the next page)

### 3 Make DAW software settings.

Device settings

Control surface settings

## NOTE

- To use the **R8** as an audio interface for DAW software (for example, Cubase LE 5) it is necessary to install the “ZOOM R8 Audio Driver”. (No driver is necessary for use with a Macintosh.) Install it correctly according to the directions given in the included installation guide.
- Download the latest **R8** audio driver from the ZOOM website.  
[http:// www.zoom.co.jp](http://www.zoom.co.jp)

### Connecting and setting the **RB**

Follow these procedures after the first time

**1** Connect the **RB** and computer with a USB cable and turn the power ON.

**2**  Press

**3** Select **AUDIO I/F**.



**ENTER** Press

**4** Select whether or not to use the settings of the previous project.



**Change menu**

**Change setting**

**5** Select **EXECUTE**.



**ENTER** Press

A USB icon appears when connection completes.



### Disconnecting

**1**  Press  
Or, press  beneath **EXIT**.

**2** Select **YES**.



**Terminate**  
**Are You Sure?**

**YES**  
**NO**

**ENTER** Press



### NOTE

Select "Continue" to use the same settings as last time.

- Insert effect settings
- Send-return effect settings
- Mixer settings
- Tuner settings

Reset

Restore default settings for each item

- The audio interface and control surface functions can be used while powered through the USB cable.
- We recommend always using the latest **RB** system software. If you use an **RB** running an older system, a computer might not recognize it properly.







# Using the tuner

The **RB** has a multifunction tuner that includes chromatic tuning, which detects notes by semitones, standard guitar/bass tuning and half-step-down tuning.

1 **TOOL** Press

2 Press the ON/OFF key for the INPUT that the instrument is connected too until its indicator lights red.

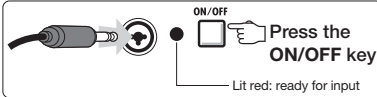

3 Select **TUNER**.



## Chromatic tuner

4 Tune the instrument

Shows whether the pitch is higher or lower than the note indicated.

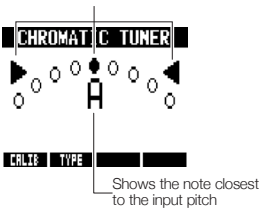

## Other tuner types

5 Press beneath **TYPE**.

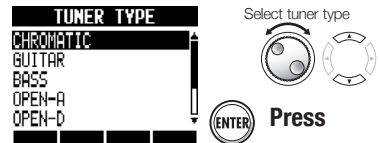

6 Select the note name/string number and tune

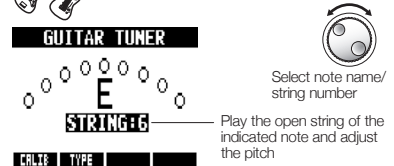

## Changing the standard pitch

7 Press beneath **CALIB** and set the standard pitch.

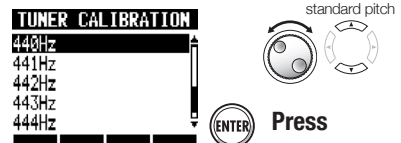

## HINT

- The pitch indicator responds to an **INPUT** when its **ON/OFF** indicator lights red.
- The standard pitch can be set between 435–445 Hz in 1 Hz units. The default setting is 440 Hz.
- With the tuner types other than chromatic, the calibration can be used to lower the pitch by 1–3 semitones (*b–bbb*).
- The standard pitch setting is saved with each project.

Tuner type	GUITAR	BASS	OPEN A	OPEN D	OPEN E	OPEN G	DADGAD
String/ note	String:1	E	G	E	D	E	D
	String:2	B	D	C#	A	B	A
	String:3	G	A	A	F#	G#	G
	String:4	D	E	E	D	E	D
	String:5	A	B	A	A	B	A
	String:6	E		E	D	E	D
	String:7	B					



# Adjusting the display

You can adjust the backlight and contrast of the display.

## Turning the backlight ON/OFF

TOOL > SYSTEM > LIGHT

**1** **TOOL** Press

**2** Select **SYSTEM**.

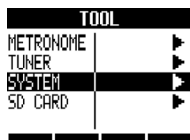

Change menu



Press

**3** Select **LIGHT**.

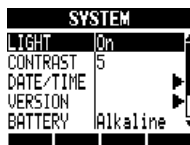

Change menu



**4** Select the setting.

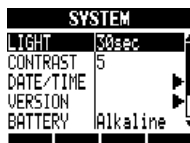

Change value



On	Backlight lit (default)
Off	Backlight unlit
15sec	Backlight darkens if the unit is not used for 15 seconds
30sec	Backlight darkens if the unit is not used for 30 seconds

## Adjusting the contrast

TOOL > SYSTEM > CONTRAST

**1** **TOOL** Press

**2** Select **SYSTEM**.

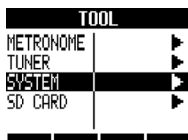

Change menu



Press

**3** Select **CONTRAST**.

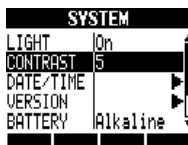

Change menu



**4** Set the value.

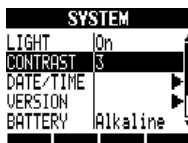

Change value



1	Low contrast	
2		
3		
4		
5		(Default value)
6		
7		
8		High contrast

## HINT

- Turn the backlight off to conserve batteries.

## Changing the SD card while the power is on



You can change the SD card while the power is on. Do this if the remaining capacity of the inserted card is low or if you need to import previously recorded data from a different SD card.

- 1 **TOOL** **Press**
- 2 **Select SD CARD.**  

Change menu
- 3 **Select EXCHANGE.**  

Change menu
- 4 **Remove the SD card.**  

Card replacement possible
- 5 **Insert the other SD card.**

### NOTE

- If the inserted SD card is already formatted for the **RB**, proceed to Step 6 of “Load data from another SD card” or “Save data to another SD card”.
- If you insert an SD card that has not been formatted follow the procedures in “Formatting an SD card” on the next page.

### Load data from another SD card

- 6 **Select LOAD.**  

Change menu

**Press**

### Save data to another SD card

- 6 **Select SAVE.**  

Change menu

**Press**

### 7 Select SAVE TO, and choose the destination project.

Change menu

Change setting

### 8 Select EXECUTE.

**Press**

See NOTE on the next page

## Formatting SD cards/Checking card capacities



### Formatting an SD card

TOOL > SD CARD > FORMAT

You should follow these steps to format SD cards for use with the **RB**. All card contents will be erased during formatting.

- 1 **TOOL** **Press**
- 2 **Select SD CARD.**  

Change menu
- 3 **Select FORMAT.**  

Change menu
- 4 **Select YES.**  

Move cursor

**Press**

### NOTE

- Disable write-protection on an SD card before inserting it.
- SAVE includes various data for the project in use, but no audio data is saved.

### Checking remaining card capacity

TOOL > SD CARD > REMAIN

You can check the remaining capacity of the SD card.

- 1 **TOOL** **Press**
- 2 **Select SD CARD.**  

Change menu
- 3 **Select REMAIN.**  

Change menu

**Press**

Card open space  
 Remaining recording time for the current recording format

### NOTE

- If you format an SD card, all its data will be permanently erased.
- When you format an SD card, all the data on the card is deleted and folders and files that are exclusively for **RB** use are created.
- If the remaining capacity of the SD card is less than the amount of the data being recorded, recording will fail. Change the card before you run out of space.

# Setting the battery type and phantom power voltage



## Setting the battery type

TOOL > SYSTEM > BATTERY

Set the battery type that you are currently using to make display of the remaining battery charge more accurate.

1

TOOL  
 Press

2

Select SYSTEM.

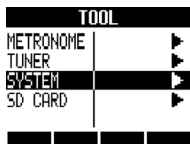

Change menu



Press

3

Select BATTERY.

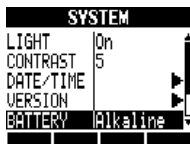

Change menu



4

Set the battery type.

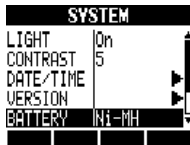

Change type

Alkaline	Alkaline batteries (default)
Ni-MH	Nickel-metal hydride batteries

## Setting phantom power voltage

TOOL > SYSTEM > PHANTOM

Set the **PHANTOM** switch to **ON** to supply phantom power to **INPUT 1** and **2**.  
 To conserve batteries, you can reduce the voltage to 24 V.

1

TOOL  
 Press

2

Select SYSTEM.

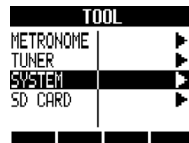

Change menu



Press

3

Select PHANTOM and set the value.

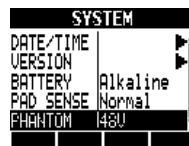

Change menu



Change setting

## NOTE

- Use only alkaline or nickel-metal hydride batteries.



# Using a footswitch

Connect a ZOOM FS01 footswitch (sold separately) to the **CONTROL IN** jack to start and stop playback, punch-in and out manually and change effect patches with your foot.

**1** **TOOL**  
 **Press**

**2** **Select SYSTEM.**

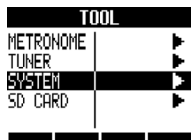

Change menu



 **Press**

**3** **Select CTRL IN.**

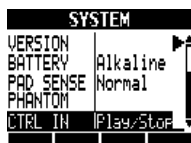

Change menu



 **Press**

**4** **Choose the setting.**

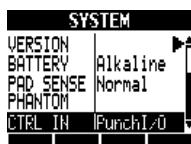

Change setting



CTRL IN: CONTROL IN setting	
Play/Stop	Each footswitch press alternately starts or stops playback.
Play/Rew	Each footswitch press alternately starts playback or rewinds
Punch/O	Allows manual punch-in and punch-out (pressing the footswitch has the same effect as pressing the REC key)
PatchUp	Pressing the footswitch increases the selected insert effect patch number by one
PatchDown	Pressing the footswitch decreases the selected insert effect patch number by one



# Checking and upgrading the firmware

## Checking the firmware version

TOOL &gt; SYSTEM &gt; VERSION

You can check the current firmware versions.

- 1 **TOOL**  
 Press

- 2 **Select SYSTEM.**

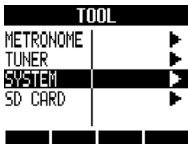

Change menu



- Press

- 3 **Select VERSION.**

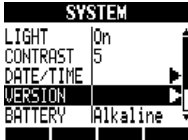

Change menu



- Press

- 4 **Check the versions.**

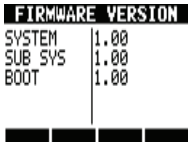

## Upgrading the firmware

You can upgrade the firmware when necessary.

You must connect the AC adapter before upgrading.

- 1 **Put the upgrade file in the root directory of an SD card.**

- 2 **Put the SD card with the upgrade file in the *RS*.**

- 3 **Connect the *RS* with the AC adapter.**

- 4 Press and hold and turn the **POWER switch ON.**

- 5 **Select OK.**



Move cursor



- Press

The upgrade starts.

- 6 **When a message shows that the upgrade has been completed, turn the *RS* power off once and restart it.**

## NOTE

- For the latest upgrade files, check the ZOOM website.  
<http://www.zoom.co.jp>



# Rhythm pattern list

Patterns 35 ~ 234 are typical patterns and fills for various genres.

No.	Pattern	Bars	43	ROCKs2FA	1	90	INDTs1Va	1	137	HIPs1VC	2	184	BALDs1VB	2
Variation			44	ROCKs2VB	2	91	INDTs1FA	1	138	HIPs1VC	1	185	BALDs1VB	1
0	08Beat01	4	45	ROCKs2Vb	1	92	INDTs1VB	2	139	HIPs1Vd	2	186	BALDs1VB	1
1	08Beat02	4	46	ROCKs2FB	1	93	INDTs1Vb	1	140	HIPs1Vd	1	187	BLUSs1VA	2
2	08Beat03	4	47	ROCKs3VA	1	94	INDTs1FB	2	141	HIPs2VA	2	188	BLUSs1Va	1
3	08Beat04	4	48	ROCKs3FA	1	95	POPs1VA	2	142	HIPs2Va	1	189	BLUSs1FA	1
4	08Beat05	4	49	ROCKs3VB	1	96	POPs1Va	1	143	HIPs2VB	2	190	BLUSs1VB	2
5	08Beat06	4	50	ROCKs3FB	1	97	POPs1FA	1	144	HIPs2Vb	1	191	BLUSs1Vb	1
6	08Beat07	4	51	ROCKs4VA	2	98	POPs1VB	2	145	HIPs2FB	1	192	BLUSs1FB	1
7	08Beat08	4	52	ROCKs4Va	1	99	POPs1Vb	1	146	HIPs2VC	2	193	CNTRs1VA	2
8	08Beat09	4	53	ROCKs4FA	1	100	POPs1FB	1	147	HIPs2VC	1	194	CNTRs1Va	1
9	08Beat10	4	54	ROCKs4VB	2	101	RnBs1VA	2	148	HIPs2VD	2	195	CNTRs1FA	1
10	08Beat11	4	55	ROCKs4Vb	1	102	RnBs1Va	1	149	DANCs1VA	1	196	CNTRs1VB	2
11	08Beat12	4	56	ROCKs4FB	1	103	RnBs1FA	1	150	DANCs1FA	1	197	CNTRs1Vb	1
12	16Beat01	4	57	HRKs1VA	1	104	RnBs1VB	2	151	DANCs1VB	1	198	CNTRs1FB	1
13	16Beat02	2	58	HRKs1FA	1	105	RnBs1Vb	1	152	DANCs1FB	1	199	JAZZs1VA	2
14	16Beat03	4	59	HRKs1VB	1	106	RnBs1FB	1	153	DANCs2VA	2	200	JAZZs1Va	1
15	16Beat04	4	60	HRKs1FB	1	107	RnBs2VA	2	154	DANCs2Va	1	201	JAZZs1FA	1
16	16Beat05	4	61	HRKs2VA	2	108	RnBs2Va	1	155	DANCs2FA	1	202	JAZZs1VB	2
17	16Beat06	4	62	HRKs2Va	1	109	RnBs2FA	1	156	DANCs2VB	2	203	JAZZs1Vb	1
18	16Beat07	2	63	HRKs2FA	1	110	RnBs2VB	2	157	DANCs2Vb	1	204	JAZZs1VB	1
19	16Beat08	2	64	HRKs2VB	2	111	RnBs2Vb	1	158	DANCs2VB	1	205	AFROs1VA	2
20	16Beat09	4	65	HRKs2Vb	1	112	RnBs2FB	1	159	HOUss1FA	1	206	AFROs1Va	1
21	16Beat10	4	66	HRKs2FB	1	113	MTNs1VA	2	160	HOUss1FA	1	207	AFROs1FA	1
22	16Beat11	4	67	MTLs1VA	1	114	MTNs1Va	1	161	HOUss1VB	1	208	AFROs1VB	2
23	16Beat12	4	68	MTLs1FA	1	115	MTNs1FA	1	162	HOUss1VB	1	209	AFROs1Vb	1
24	16FUS01	2	69	MTLs1VB	1	116	MTNs1VB	2	163	TECHs1FA	1	210	AFROs1FB	1
25	16FUS02	2	70	MTLs1FB	1	117	MTNs1Vb	1	164	TECHs1FA	1	211	REGGs1VA	2
26	16FUS03	4	71	FUSs1VA	2	118	MTNs1FB	1	165	TECHs1VB	1	212	REGGs1Va	1
27	16FUS04	2	72	FUSs1Va	1	119	FUNKs1VA	2	166	TECHs1FB	1	213	REGGs1FA	1
28	04JAZZ01	4	73	FUSs1FA	1	120	FUNKs1Va	1	167	DnBs1VA	2	214	REGGs1VB	1
29	04JAZZ02	4	74	FUSs1VB	2	121	FUNKs1FA	1	168	DnBs1Va	1	215	REGGs1Vb	1
30	04JAZZ03	4	75	FUSs1Vb	1	122	FUNKs1VB	2	169	DnBs1FA	1	216	REGGs1FB	1
31	04JAZZ04	4	76	FUSs1FB	1	123	FUNKs1Vb	1	170	DnBs1VB	2	217	LATNs1VA	2
32	DANCE	2	77	FUSs2VA	2	124	FUNKs1FB	1	171	DnBs1Vb	1	218	LATNs1Va	1
33	CNTRY	2	78	FUSs2Va	1	125	FUNKs2VA	2	172	DnBs1FB	1	219	LATNs1FA	1
34	68BLUS	4	79	FUSs2FA	1	126	FUNKs2Va	1	173	TPs1VA	1	220	LATNs1VB	2
			80	FUSs2VB	2	127	FUNKs2FA	1	174	TPs1FA	1	221	LATNs1Vb	1
No.	Pattern	Bars	81	FUSs2Vb	1	128	FUNKs2VB	2	175	TPs1VB	1	222	LATNs1FB	1
Genre fills/variations			82	FUSs2FB	1	129	FUNKs2Vb	1	176	TPs1FB	1	223	LATNs2VA	2
35	ROCKs1VA	2	83	FUSs3VA	2	130	FUNKs2FB	1	177	AMBs1VA	2	224	LATNs2Va	1
36	ROCKs1Va	1	84	FUSs3Va	1	131	HIPs1VA	2	178	AMBs1Va	1	225	LATNs2FA	1
37	ROCKs1FA	1	85	FUSs3FA	1	132	HIPs1Va	1	179	AMBs1FA	1	226	LATNs2VB	2
38	ROCKs1VB	2	86	FUSs3VB	2	133	HIPs1FA	1	180	AMBs1FB	1	227	LATNs2Vb	1
39	ROCKs1Vb	1	87	FUSs3Vb	1	134	HIPs1VB	2	181	BALDs1VA	2	228	LATNs2FB	1
40	ROCKs1FB	1	88	FUSs3FB	1	135	HIPs1Vb	1	182	BALDs1Va	1	229	MidEs1VA	2
41	ROCKs2VA	2	89	INDTs1VA	2	136	HIPs1VB	1	183	BALDs1FA	1	230	MidEs1Va	1
42	ROCKs2Va	1												



231	MidEs1FA	1	281	FUS04	2	333	HIP14	2	385	BALD09	2	437	LATN12	2
232	MidEs1VB	2	282	FUS05	2	334	HIP15	2	386	BALD10	2	438	BOSSA01	4
233	MidEs1Vb	1	283	FUS06	2	335	HIP16	2	387	BALD11	4	439	BOSSA02	4
234	MidEs1FB	1	284	FUS07	2	336	HIP17	2	388	BLUS01	2	440	SAMBA01	4
No.	Pattern	Bars	285	FUS08	2	337	HIP18	2	389	BLUS02	2	441	SAMBA02	4
	Standard		286	POP01	2	338	HIP19	2	390	BLUS03	2	442	MidE01	2
235	ROCK01	2	287	POP02	2	339	HIP20	2	391	BLUS04	2	443	MidE02	2
236	ROCK02	2	288	POP03	2	340	HIP21	2	392	BLUS05	2	444	MidE03	2
237	ROCK03	2	289	POP04	2	341	HIP22	2	393	BLUS06	2	445	MidE04	2
238	ROCK04	2	290	POP05	2	342	HIP23	2	394	CNTR01	2	446	INTRO01	1
239	ROCK05	2	291	POP06	2	343	DANC01	2	395	CNTR02	2	447	INTRO02	1
240	ROCK06	2	292	POP07	2	344	DANC02	2	396	CNTR03	2	448	INTRO03	1
241	ROCK07	2	293	POP08	2	345	DANC03	2	397	CNTR04	2	449	INTRO04	1
242	ROCK08	2	294	POP09	2	346	DANC04	2	398	JAZZ01	2	450	INTRO05	1
243	ROCK09	2	295	POP10	2	347	DANC05	2	399	JAZZ02	2	451	INTRO06	1
244	ROCK10	2	296	POP11	2	348	DANC06	2	400	JAZZ03	2	452	INTRO07	1
245	ROCK11	4	297	POP12	2	349	HOUS01	2	401	JAZZ04	2	453	INTRO08	1
246	ROCK12	2	298	RnB01	2	350	HOUS02	2	402	JAZZ05	2	454	INTRO09	1
247	ROCK13	2	299	RnB02	2	351	HOUS03	2	403	JAZZ06	2	455	INTRO10	1
248	ROCK14	2	300	RnB03	2	352	HOUS04	2	404	JAZZ07	4	456	INTRO11	1
249	ROCK15	2	301	RnB04	2	353	TECH01	2	405	SHFLO1	2	457	INTRO12	1
250	ROCK16	2	302	RnB05	2	354	TECH02	2	406	SHFL02	2	458	INTRO13	1
251	ROCK17	2	303	RnB06	2	355	TECH03	2	407	SHFL03	2	459	INTRO14	1
252	ROCK18	2	304	RnB07	2	356	TECH04	2	408	SHFL04	2	460	INTRO15	1
253	ROCK19	2	305	RnB08	2	357	TECH05	2	409	SHFL05	2	461	INTRO16	1
254	ROCK20	2	306	RnB09	2	358	TECH06	2	410	SKA01	2	462	INTRO17	1
255	ROCK21	2	307	RnB10	2	359	TECH07	2	411	SKA02	2	463	INTRO18	1
256	ROCK22	2	308	FUNK01	2	360	TECH08	2	412	SKA03	2	464	ENDING01	1
257	ROCK23	2	309	FUNK02	2	361	TECH09	2	413	SKA04	2	465	ENDING02	1
258	ROCK24	2	310	FUNK03	2	362	TECH10	2	414	REGG01	2	466	ENDING03	1
259	ROCK25	2	311	FUNK04	2	363	DnB01	2	415	REGG02	2	467	ENDING04	1
260	ROCK26	2	312	FUNK05	2	364	DnB02	2	416	REGG03	2	468	ENDING05	1
261	ROCK27	2	313	FUNK06	2	365	DnB03	2	417	REGG04	2	469	ENDING06	1
262	ROCK28	2	314	FUNK07	2	366	DnB04	2	418	AFRO01	2	470	ENDING07	1
263	HRK01	2	315	FUNK08	2	367	DnB05	2	419	AFRO02	2	471	COUNT	2
264	HRK02	2	316	FUNK09	2	368	DnB06	2	420	AFRO03	2	472		
265	HRK03	2	317	FUNK10	2	369	TRIP01	2	421	AFRO04	2	-	EMPTY	2
266	HRK04	2	318	FUNK11	2	370	TRIP02	2	422	AFRO05	2	510		
267	HRK05	2	319	FUNK12	2	371	TRIP03	2	423	AFRO06	2			
268	HRK06	2	320	HIP01	2	372	TRIP04	2	424	AFRO07	2			
269	HRK07	2	321	HIP02	2	373	AMB01	2	425	AFRO08	2			
270	MTL01	2	322	HIP03	2	374	AMB02	2	426	LATN01	2			
271	MTL02	2	323	HIP04	2	375	AMB03	2	427	LATN02	2			
272	MTL03	2	324	HIP05	2	376	AMB04	2	428	LATN03	2			
273	MTL04	2	325	HIP06	2	377	BALD01	2	429	LATN04	2			
274	THRS01	2	326	HIP07	2	378	BALD02	2	430	LATN05	2			
275	THRS02	2	327	HIP08	2	379	BALD03	2	431	LATN06	2			
276	PUNK01	2	328	HIP09	2	380	BALD04	2	432	LATN07	2			
277	PUNK02	2	329	HIP10	2	381	BALD05	2	433	LATN08	2			
278	FUS01	2	330	HIP11	2	382	BALD06	2	434	LATN09	2			
279	FUS02	2	331	HIP12	2	383	BALD07	2	435	LATN10	2			
280	FUS03	2	332	HIP13	2	384	BALD08	2	436	LATN11	2			

# Effect types and parameters 1

## INSERT effects

Clean/Crunch, Distortion, Aco/Bass SIM algorithms

- COMP/LIMITER module

Type	Parameters			
Compressor	Sense	Attack	Tone	Level
	MXR Dynacomp type compressor.			
Rack Comp	Threshold	Ratio	Attack	Level
	Compressor with more detailed adjustments.			
Limiter	Threshold	Ratio	Release	Level
	Limiter for suppressing signal peaks above a certain level.			

### Parameter Explanations

Parameters	Setting range	Explanation
Sense	0 ~ 10	Adjusts compressor sensitivity.
Attack	Compressor: Fast, Slow	Selects compressor response speed.
	Rack Comp: 1 ~ 10	Adjusts compressor response speed.
Tone	0 ~ 10	Adjusts tonal quality.
Level	2 ~ 100	Adjusts signal level after passing module.
Threshold	0 ~ 50	Adjusts threshold for compressor/limiter action.
Ratio	1 ~ 10	Adjusts compressor/limiter compression ratio.
Release	1 ~ 10	Adjusts delay until compressor/limiter release from time when signal level falls below threshold level.

# Effect types and parameters 2

□ EFX module

Type	Parameters						
Auto Wah	Position	Sense	Resonance	Level			
	Auto wah dependent on dynamics of input signal.						
Tremolo	Depth	Rate	Wave	Level			
	Periodically varies the volume level.						
Phaser	Position	Rate	Color	Level			
	Produces a swooshing sound.						
Ring Modulator	Position	Frequency	Balance	Level			
	Produces a metallic ringing sound. Adjusting the Frequency parameter results in a drastic change of sound character.						
Slow Attack	Position	Time	Curve	Level			
	Slows down the attack rate of the sound.						
Fix-Wah	Position	Frequency	Dry Mix	Level	RTM Mode	RTM Wave	RTM Sync
	Changes the wah frequency according to rhythm tempo.						
Booster	Range	Tone	Level				
	Increases signal gain to make the sound more powerful.						

## Parameter Explanations

Parameters	Setting range	Explanation
Position	Before, After	Sets connection position of EFX module to before or after preamp.
Sense	-10 ~ -1, 1 ~ 10	Adjusts auto wah sensitivity.
Resonance	0 ~ 10	Adjusts resonance intensity.
Level	2 ~ 100	Adjusts signal level after passing through module.
Depth	0 ~ 100	Adjusts modulation depth.
Rate	0 ~ 50 ♪ (P.127 Table 1)	Adjusts modulation rate. Can be set in rhythm tempo note units.
Wave	4Up 0 ~ 9, Down 0 ~ 9, Tri 0 ~ 9	Sets modulation waveform to "Up" (rising sawtooth), "Down" (falling sawtooth) or "Tri" (triangular). Higher values result in stronger clipping, emphasizing the effect.
Color	4Stage, 8Stage, Invert4, Invert8	Selects sound type.
Frequency	Ring Modulator: 1 ~ 50	Adjusts frequency used for modulation.
	Fix-Wah: 1 ~ 50	Adjusts wah center frequency.
Balance	0 ~ 100	Adjusts balance between original sound and effect sound.
Time	1 ~ 50	Adjusts rise time for sound.
Curve	0 ~ 10	Adjusts volume rise curve.
Dry Mix	0 ~ 10	Adjusts original sound mix ratio.
RTM Mode	P.127 Table 2	Adjusts change range and direction.
RTM Wave	P.127 Table 3	Selects control waveform.
RTM Sync	♪ (P.127 Table 4)	Adjusts control wave frequency.
Range	1 ~ 5	Selects frequency range to boost.
Tone	0 ~ 10	Adjusts tone.

# Effect types and parameters 3

• PREAMP module

Type	Parameters			
<b>FD Combo</b>	Modeled sound of Fender Twin Reverb ('65 model) favored by guitarists of many music styles			
<b>VX Combo</b>	Modeled sound of combo amp VOX AC-30 operating in class A			
<b>US Blues</b>	Crunch sound of FENDER Tweed BASSMAN			
<b>BG Crunch</b>	Crunch sound of Mesa Boogie MkIII combo amp			
<b>HW Stack</b>	Modeled sound of legendary all-tube Hiwatt Custom 100 from Britain			
<b>MS Crunch</b>	Crunch sound of legendary Marshall 1959			
<b>MS Drive</b>	High gain sound of Marshall JCM2000 stack amp			
<b>PV Drive</b>	High gain sound of Peavey 5150 developed in cooperation with a world-famous hard rock guitarist			
<b>DZ Drive</b>	High gain sound using channel 3 the Diezel Herbert hand-made German guitar amp with three separately controllable channels			
<b>BG Drive</b>	High gain sound of Mesa Boogie Dual Rectifier red channel (vintage mode)			
<b>OverDrive</b>	Modeling of BOSS OD-1 effect pedal that was the world's first overdrive effect of its kind			
<b>T Scream</b>	Simulation of the Ibanez TS808, which is loved by many guitarists as a booster and has inspired numerous clones			
<b>Governor</b>	Simulation of the Guv'nor distortion effect from Marshall			
<b>Dist +</b>	Simulation of the MXR distortion+ effect that made distortion popular worldwide			
<b>Dist 1</b>	Simulation of the Boss DS-1 distortion pedal, which has been a long-seller			
<b>Squeak</b>	Simulation of the PROCO Rat famous for its edgy distortion sound			
<b>FuzzSmile</b>	Simulation of the Fuzz Face, which has made rock history with its humorous panel design and smashing sound			
<b>GreatMuff</b>	Simulation of the Electro-Harmonix Big Muff, which is loved by famous artists around the world for its fat, sweet fuzz sound			
<b>MetalWRLD</b>	Simulation of the Boss Metal Zone, which is characterized by long sustain and a powerful lower midrange			
<b>HotBox</b>	Simulation of the compact Matchless Hotbox pre-amplifier with a built-in tube			
<b>Z Clean</b>	ZOOM original unadorned clean sound			
<b>Z Wild</b>	A high gain sound with even more overdrive boost.			
<b>Z MP1</b>	An original sound created by merging characteristics of an ADA MP1 and a MARSHALL JCM800.			
<b>Z Bottom</b>	A high gain sound that emphasizes low and middle frequencies			
<b>Z Dream</b>	A high gain sound for lead playing based on the Mesa Boogie Road King Series II Lead channel			
<b>Z Scream</b>	An original high gain sound balanced from low to high frequencies			
<b>Z Neos</b>	A crunch sound modeled on the sound of a modified VOX AC30			
<b>Lead</b>	A bright and smooth distortion sound			
<b>ExtremeDS</b>	This distortion effect boasts the highest gain in the world			
	<b>Gain</b>	<b>Tone</b>	<b>Cabinet</b>	<b>Level</b>
	FD Combo ~ ExtremeDS types have the same parameters			
<b>Acoustic Sim</b>	<b>Top</b>	<b>Body</b>	<b>Level</b>	
	Makes an electric guitar sound like an acoustic guitar			
<b>Bass Sim</b>	<b>Tone</b>	<b>Level</b>		
	Makes an electric guitar sound like a bass guitar			

Parameter Explanations

Parameters	Setting range	Explanation
<b>Gain</b>	0 ~ 100	Adjusts preamp gain (distortion intensity).
<b>Tone</b>	0 ~ 30	Adjusts tonal quality.
<b>Cabinet</b>	Matched	Optimizes cabinet settings according to the drive effect type.
	Combo	Simulates 2x12 Fender combo amp cabinet.
	Tweed	Simulates 4x10 Fender Tweed amp cabinet.
	Stack	Simulates 4x12 Marshall stack amp cabinet.
<b>Level</b>	1 ~ 100	Adjusts signal level after passing through module.
<b>Top</b>	0 ~ 10	Adjusts characteristic acoustic guitar string resonance.
<b>Body</b>	0 ~ 10	Adjusts characteristic acoustic guitar body resonance.

• 6BAND EQ module

Type	Parameters						
<b>6Band EQ</b>	<b>Bass</b>	<b>Low-Mid</b>	<b>Middle</b>	<b>Treble</b>	<b>Presence</b>	<b>Harmonics</b>	<b>Level</b>
	This is an equalizer with 6 frequency bands						

Parameter Explanations

Parameters	Setting range	Explanation
<b>Bass</b>	-12 dB ~ 12 dB	Adjusts low frequency range (160 Hz) boost/cut.
<b>Low-Mid</b>	-12 dB ~ 12 dB	Adjusts mid-low-frequency range (400 Hz) boost/cut.
<b>Middle</b>	-12 dB ~ 12 dB	Adjusts middle-frequency range (800 Hz) boost/cut.
<b>Treble</b>	-12 dB ~ 12 dB	Adjusts high-frequency range (3.2 kHz) boost/cut.
<b>Presence</b>	-12 dB ~ 12 dB	Adjusts super-high-frequency range (6.4 kHz) boost/cut.

# Effect types and parameters 4

Parameters	Setting range	Explanation
Harmonics	-12 dB ~ 12 dB	Adjust harmonics (12 kHz) boost/cut.
Level	2 ~ 100	Adjusts signal level after passing through module.

• MOD/DELAY module

Type	Parameters			
Chorus	Depth	Rate	Tone	Mix
	Mixes a variable pitch-shifted component with the original sound, resulting in full-bodied resonating tone			
Ensemble	Depth	Rate	Tone	Mix
	Chorus ensemble features three-dimensional movement			
Flanger	Depth	Rate	Resonance	Manual
	Produces a resonating and strongly undulating sound			
Pitch	Shift	Tone	Fine	Balance
	Shifts the pitch up or down			
Vibe	Depth	Rate	Tone	Balance
	Adds automatic vibrato			
Step	Depth	Rate	Resonance	Shape
	Special effect makes sound changes in steps			
Cry	Range	Resonance	Sense	Balance
	Changes sound like a talking modulator			
Exciter	Frequency	Depth	Low Boost	
	Enhances the sound outline, making it more prominent			
Air	Size	Reflex	Tone	Mix
	Recreates the airy ambience of a room, adding a feeling of depth			
Delay	Time	Feedback	Hi Damp	Mix
	Delay effect with a maximum setting of 2000 ms			
Analog Delay	Time	Feedback	Hi Damp	Mix
	Warm analog delay simulation with up to 2000 msec delay length			
Reverse Delay	Time	Feedback	Hi Damp	Balance
	Reverse delay with a maximum length of 1000 msec			
ARRM Pitch	Type	Tone	RTM Wave	RTM Sync
	Changes pitch of original sound in time with the rhythm tempo			

Parameter Explanations

Parameters	Setting range	Explanation
Depth	Exciter: 0 ~ 30	Adjusts depth of effect.
	Other: 0 ~ 100	Adjusts modulation depth.
Rate	Chorus, Ensemble: 1 ~ 50	Adjusts modulation speed.
	Flanger, Vibe, Step: 0 ~ 50 ♪ (P.127 Table 1)	Adjusts modulation speed. Using the rhythm tempo as reference, setting in note units is also possible.
Tone	0 ~ 10	Adjusts tonal quality.
Mix	0 ~ 100	Adjusts mix ratio of effect sound to original sound.
Resonance	Flanger: -10 ~ 10	Adjusts resonance intensity. Negative values result in the effect sound phase being emphasized.
	Step, Cry: 0 ~ 10	Adjusts resonance intensity.
Manual	0 ~ 100	Adjust the frequency range that is effected.
Shift	-12 ~ 12, 24	Sets pitch shift in semitones.
Fine	-25 ~ 25	Sets pitch shift in cents (1/100 semitone).
Balance	0 ~ 100	Adjusts balance between original sound and effect sound.
Shape	0 ~ 10	Sets effect sound envelope.
Range	1 ~ 10	Adjusts the frequency range that is affected.
Sense	-10 ~ -1, 1 ~ 10	Sets the sensitivity of the effect.
Frequency	1 ~ 5	Adjusts the frequencies that are effected.
Low Boost	0 ~ 10	Emphasizes low-frequency range.
Size	1 ~ 100	Sets size of simulated space.
Reflex	0 ~ 10	Adjusts the amount of reflections from the walls.
Time	Delay, Analog Delay: 1 ~ 2000 ms ♪ (P.127 Table 1)	Adjusts delay time.
	Reverse Delay: 10 ~ 1000 ms ♪ (P.127 Table 1)	
Feedback	0 ~ 100	Adjusts feedback amount.
Hi Damp	0 ~ 10	Adjusts the high-frequency attenuation of the delay sound.
Type	P.127 Table 5	Selects the type of pitch change.
RTM Wave	P.127 Table 3	Selects the wave shape of the effect.
RTM Sync	P.127 Table 4	Sets the frequency of the wave.

# Effect types and parameters 5

- REVERB module

Type	Parameters			
Hall	Decay	PreDelay	Tone	Mix
	Simulates the acoustics of a concert hall			
Room	Decay	PreDelay	Tone	Mix
	Simulates the acoustics of a room			
Spring	Decay	PreDelay	Tone	Mix
	Simulates a spring reverb			
Arena	Decay	PreDelay	Tone	Mix
	Simulates the acoustics of an arena-sized venue			
TiledRoom	Decay	PreDelay	Tone	Mix
	Simulates the acoustics of a tiled room			

## Parameter Explanations

Parameters	Setting range	Explanation
Decay	1 ~ 30	Adjusts reverb time.
PreDelay	1 ~ 100	Adjusts pre-delay time.
Tone	0 ~ 10	Adjusts tonal quality.
Mix	0 ~ 100	Adjusts effect sound level.

- ZNR module

Type	Setting range	Explanation
ZNR	Off, 1 ~ 30	Adjusts sensitivity.
	Set value as high as possible without causing unnatural decay to reduce noise. ZOOM original noise reduction for reducing noise during playing pauses without affecting the overall tone.	

## Bass algorithm

- COMP/LIMITER module

Type	Parameters
Rack Comp	For an explanation of types and parameters, see Clean/Crunch, Distortion, Aco/Bass SIM algorithms.
Limiter	

- EFX module

Type	Parameters				
Auto Wah	Position	Sense	Resonance	Dry Mix	Level
	This effect varies the wah action according to the intensity of the input signal.				
Tremolo	For an explanation of types and parameters, see Clean/Crunch, Distortion, Aco/Bass SIM algorithms.				
Phaser					
Ring Modulator					
Slow Attack					
Fix-Wah					

## Parameter Explanations

Parameters	Setting range	Explanation
Position	Before, After	Sets insert position of module to before or after PREAMP module.
Sense	-10 ~ -1, 1 ~ 10	Adjusts auto wah sensitivity.
Resonance	0 ~ 10	Adjusts resonance intensity.
Dry Mix	0 ~ 10	Adjusts original sound mix ratio.
Level	2 ~ 100	Adjusts signal level after passing through module.

- PREAMP module

Type	Parameters				
SVT	Simulation of Ampeg SVT sound.				
Bassman	Simulation of Fender Bassman 100 sound.				
Hartke	Simulation of Hartke HA3500 sound.				
Super Bass	Simulation of Marshall Super Bass sound.				
SANSAMP	Simulation of Sansamp Bass Driver DI sound.				
Tube Preamp	ZOOM original tube preamplifier sound.				
	Gain	Tone	Cabinet	Balance	Level
All preamp modules have the same parameters.					

# Effect types and parameters 6

## Parameter Explanations

Parameters	Setting range	Explanation
Gain	0 ~ 100	Adjusts preamp gain (distortion depth).
Tone	0 ~ 30	Adjusts tonal quality of effect.
Cabinet	0 ~ 2	Adjusts intensity of speaker cabinet sound.
Balance	0 ~ 100	Adjusts mix balance of signal before and after module.
Level	1 ~ 100	Adjusts signal level after passing through module.

### • 6BAND EQ module

Type	Parameters						
6Band EQ	Sub-Bass	Bass	Low-Mid	Hi-Mid	Treble	Presence	Level
	This is an equalizer with 6 frequency bands.						

## Parameter Explanations

Parameters	Setting range	Explanation
Sub-Bass	-12 dB ~ 12 dB	Adjusts super-low frequency range (70 Hz) boost/cut.
Bass	-12 dB ~ 12 dB	Adjusts low frequency range (150 Hz) boost/cut.
Low-Mid	-12 dB ~ 12 dB	Adjusts mid-low-frequency range (450 Hz) boost/cut.
Hi-Mid	-12 dB ~ 12 dB	Adjusts high-mid-frequency range (1 kHz) boost/cut.
Treble	-12 dB ~ 12 dB	Adjusts high-frequency range (3 kHz) boost/cut.
Presence	-12 dB ~ 12 dB	Adjusts super-high-frequency range (6 kHz) boost/cut.
Level	2 ~ 100	Adjusts signal level after passing through module.

### • MOD/DELAY module

Type	Parameters
Chorus ~ ARRM Pitch	For an explanation of types and parameters, see Clean/Crunch, Distortion, Aco/Bass SIM algorithms.

### • ZNR module

Type	Parameters
ZNR	For an explanation of types and parameters, see Clean/Crunch, Distortion, Aco/Bass SIM algorithms.

Mic algorithm

### • COMP/LIMITER module

Type	Parameters
Rack Comp Limiter	For an explanation of types and parameters, see Clean/Crunch, Distortion, Aco/Bass SIM algorithms.

### • EFX module

Type	Parameters
Tremolo	For an explanation of types and parameters, see Clean/Crunch, Distortion, Aco/Bass SIM algorithms.
Phaser	
Ring Modulator	
Slow Attack	
Fix-Wah	

### • MIC PRE module

Type	Parameters				
Mic Pre	Type	Tone	Level	De-Esser	Low Cut
	This is a preamplifier for use with external microphones.				

## Parameter Explanations

Parameters	Setting range	Explanation
Type	Vocal, AcousticGt, Flat	Selects preamp characteristics.
Tone	0 ~ 10	Adjusts tonal quality of effect.
Level	1 ~ 100	Adjusts signal level after passing through module.
De-Esser	Off, 1 ~ 10	Sets the reduction of sibilant sounds.
Low Cut	Off, 80 ~ 240 Hz	Sets frequency of filter that reduces low-frequency noise easily picked up by mics.

# Effect types and parameters 7

- 3BAND EQ module

Type	Parameters			
3Band EQ	Bass	Middle	Treble	Level
	This is a 3-band equalizer.			

Parameter Explanations

Parameters	Setting range	Explanation
Bass	-12 dB ~ 12 dB	Boosts/cuts low-frequency range.
Middle	-12 dB ~ 12 dB	Boosts/cuts middle-frequency range.
Treble	-12 dB ~ 12 dB	Boosts/cuts high-frequency range.
Level	2 ~ 100	Adjusts signal level after passing through module.

- MOD/DELAY module

Type	Parameters
Chorus ~ ARRMR Pitch	For an explanation of types and parameters, see Clean/Crunch, Distortion, Aco/Bass SIM algorithms.

- ZNR module

Type	Parameters
ZNR	For an explanation of types and parameters, see Clean/Crunch, Distortion, Aco/Bass SIM algorithms.

## Dual Mic algorithm

- COMP/LIMITER L module

Type	Parameters			
Compressor	Threshold	Ratio	Attack	Level
	Reduces variation in signal level.			
Limiter	Threshold	Ratio	Release	Level
	Attenuates signals that exceed a certain level.			

Parameter Explanations

Parameters	Setting range	Explanation
Threshold	-24 ~ 0	Adjusts threshold level of compressor/limiter.
Ratio	Compressor: 1 ~ 26	Adjusts compression ratio of compressor/limiter.
	Limiter: 1 ~ 54, ∞	
Attack	0 ~ 10	Adjusts speed that at which the compressor is activated.
Level	2 ~ 100	Adjusts module output level.
Release	0 ~ 10	Adjusts speed of limiter release after signal falls below threshold level.

- MIC PRE L module

Type	Parameters
Mic Pre	For an explanation of types and parameters, see Mic algorithm.

- 3BAND EQ L module

Type	Parameters
3Band EQ	For an explanation of types and parameters, see Mic algorithm.

- DELAY L module

Type	Parameters		
Delay	Time	Feedback	Mix
	Delay effect with a maximum setting of 2000 ms.		
Echo	Time	Feedback	Mix
	Warm delay effect with a maximum setting of 2000 ms.		
Doubling	Time	Tone	Mix
	Doubling effect that creates body by adding a short delay.		

Parameter Explanations

Parameters	Setting range	Explanation
Time	Delay, Echo: 1 ~ 2000 ms ♪ (P.127 Table 1)	Adjusts delay time.
	Doubling: 1 ~ 100 ms	
Feedback	0 ~ 100	Adjusts feedback amount.
Tone	0 ~ 10	Adjusts tonal quality.
Mix	0 ~ 100	Adjusts mix ratio of effect sound to original sound.



# Effect types and parameters 8

- COMP/LIMITER R module

Type	Parameters
<b>Compressor</b>	For an explanation of types and parameters, see COMP/LIMITER L module.
<b>Limiter</b>	

- MIC PRE R module

Type	Parameters
<b>Mic Pre</b>	For an explanation of types and parameters, see Mic algorithm.

- 3BAND EQ R module

Type	Parameters
<b>3Band EQ</b>	For an explanation of types and parameters, see Mic algorithm.

- DELAY R module

Type	Parameters
<b>Delay</b>	For an explanation of types and parameters, see DELAY L module.
<b>Echo</b>	
<b>Doubling</b>	

- ZNR module

Type	Parameters
<b>ZNR L</b>	For an explanation of types and parameters, see Clean/Crunch, Distortion, Aco/Bass SIM algorithms.
<b>ZNR R</b>	For an explanation of types and parameters, see Clean/Crunch, Distortion, Aco/Bass SIM algorithms.

## Stereo algorithm

- COMP/LIMITER module

Type	Parameters												
<b>Compressor</b>	For an explanation of types and parameters, see Dual Mic algorithms.												
<b>Limiter</b>													
<b>Lo-Fi</b>	<table border="1"> <thead> <tr> <th>Character</th> <th>Color</th> <th>Dist</th> <th>Tone</th> <th>EFX Level</th> <th>Dry Level</th> </tr> </thead> <tbody> <tr> <td colspan="6">This effect intentionally reduces the quality of the sound.</td> </tr> </tbody> </table>	Character	Color	Dist	Tone	EFX Level	Dry Level	This effect intentionally reduces the quality of the sound.					
Character	Color	Dist	Tone	EFX Level	Dry Level								
This effect intentionally reduces the quality of the sound.													

### Parameter Explanations

Parameters	Setting range	Explanation
<b>Character</b>	0 ~ 10	Adjusts filter characteristics.
<b>Color</b>	1 ~ 10	Adjusts sound color.
<b>Dist</b>	0 ~ 10	Adjusts distortion.
<b>Tone</b>	0 ~ 10	Adjusts tonal quality of effect.
<b>EFX Level</b>	0 ~ 100	Adjusts effect sound level.
<b>Dry Level</b>	0 ~ 100	Adjusts original sound level.

- ISO/MIC MODEL module

Type	Parameters										
<b>Isolator</b>	<table border="1"> <thead> <tr> <th>Xover Lo</th> <th>Xover Hi</th> <th>Mix High</th> <th>Mix Mid</th> <th>Mix Low</th> </tr> </thead> <tbody> <tr> <td colspan="5">Divides the signal into three frequency bands and allows the mix amount of each band to be adjusted separately.</td> </tr> </tbody> </table>	Xover Lo	Xover Hi	Mix High	Mix Mid	Mix Low	Divides the signal into three frequency bands and allows the mix amount of each band to be adjusted separately.				
Xover Lo	Xover Hi	Mix High	Mix Mid	Mix Low							
Divides the signal into three frequency bands and allows the mix amount of each band to be adjusted separately.											
<b>Mic Modeling</b>	<table border="1"> <thead> <tr> <th>Mic Type</th> </tr> </thead> <tbody> <tr> <td>Changes built-in mic characteristics.</td> </tr> </tbody> </table>	Mic Type	Changes built-in mic characteristics.								
Mic Type											
Changes built-in mic characteristics.											

### Parameter Explanations

Parameters	Setting range	Explanation
<b>Xover Lo</b>	50 Hz ~ 16 kHz	Adjusts low-to-mid crossover frequency.
<b>Xover Hi</b>	50 Hz ~ 16 kHz	Adjusts mid-to-high crossover frequency.
<b>Mix High</b>	Off, -24 ~ 6	Adjusts high frequency range mix level.
<b>Mix Mid</b>	Off, -24 ~ 6	Adjusts mid frequency range mix level.
<b>Mix Low</b>	Off, -24 ~ 6	Adjusts low frequency range mix level.
<b>Mic Type</b>	SM57	Simulation of SM57 mic, which is great for recording electric guitars and other analog instruments.
	MD421	Simulation of MD421, which is a professional standard mic that is indispensable in broadcasting, recording and live performances.
	U87	Simulation of U87, a "go-to" condenser microphone that is used in studios worldwide.
	C414	Simulation of C414, a famous microphone highly trusted in recording situations.

# Effect types and parameters 9

## • 3BAND EQ module

Type	Parameters
3Band EQ	For an explanation of types and parameters, see Mic algorithm.

## • MOD/DELAY module

Type	Parameters						
Chorus	Depth		Rate		Mix		
	Mixes a variable pitch-shifted component with the original sound, resulting in full-bodied resonating tone.						
Flanger	Depth		Rate		Resonance		
	Produces a resonating and strongly undulating sound.						
Phaser	Rate		Color		LFO Shift		
	Produces a swooshing sound.						
Tremolo	Depth		Rate		Clip		
	Periodically varies the volume level.						
Auto Pan	Width		Rate		Clip		
	Pans the sound alternately left and right.						
Pitch	Shift		Tone		Fine		Balance
	Shifts the pitch up or down.						
Ring Modulator	For an explanation of types and parameters, see Clean/Crunch, Distortion, Aco/Bass SIM algorithms.						
Delay	Time		Feedback		Mix		
	Delay effect with a maximum setting of 2000 ms.						
Echo	Time		Feedback		Mix		
	Warm delay effect with a maximum setting of 2000 ms.						
Doubling	Time		Tone		Mix		
	Doubling effect which creates body by adding a short delay.						
Dimension	Rise1		Rise2				
	Expands sound spatially.						
Resonance	Depth	Freq OFST	Rate	Filter	Resonance	EFX Level	Dry Level
	Resonant filter with LFO.						

## Parameter Explanations

Parameters	Setting range	Explanation
Depth	0 ~ 100	Adjusts modulation depth.
Resonance	-10 ~ 10	Adjusts resonance intensity. Negative values result in the effect sound phase being emphasized.
Color	4Stage, 8Stage, Invert4, Invert8	Selects sound type.
LFO Shift	0 ~ 180	Adjusts left/right phase shift.
Width	0 ~ 10	Adjusts auto pan width.
Rate	Chorus: 1 ~ 50	Adjusts modulation speed.
	Flanger, Phaser, Tremolo, Auto Pan: 0 ~ 50 ♪ (P.127 Table 1) Resonance: 1 ~ 50 ♪ (P.127 Table 1)	Adjusts modulation speed. Using the rhythm tempo as reference, setting in note units is also possible
Clip	0 ~ 10	Adds emphasis by clipping the modulation waveform.
Shift	-12 ~ 12, 24	Adjusts the pitch shift in semitones.
Time	Delay, Echo: 1 ~ 2000 ms ♪ (P.127 Table 1) Doubling: 1 ~ 100 ms	Adjusts delay time.
Feedback	0 ~ 100	Adjusts feedback amount.
Mix	0 ~ 100	Adjusts mix ratio of effect sound to original sound.
Tone	0 ~ 10	Adjusts tonal quality.
Fine	-25 ~ 25	Adjusts the pitch shift in cents (1/100 semitone).
Balance	0 ~ 100	Adjusts balance between original sound and effect sound.
Rise1	0 ~ 30	Adjusts stereo component intensity.
Rise2	0 ~ 30	Adjusts width including mono elements.
Freq OFST	1 ~ 30	Adjusts LFO offset.
Filter	HPF, LPF, BPF	Selects filter type.
Resonance	1 ~ 30	Adjusts resonance intensity.
EFX Level	0 ~ 100	Adjusts effect sound level.
Dry Level	0 ~ 100	Adjusts original sound level.

## • ZNR module

Type	Parameters
ZNR	For an explanation of types and parameters, see Clean/Crunch, Distortion, Aco/Bass SIM algorithms.

# Effect types and parameters 10

Table 1 Parameters marked with ♪ allow values to be set in note units, using the song/pattern tempo as reference. The note durations for the setting values are shown below.

♪	32nd note	♪.	Dotted 16th note	♪.	Dotted 8th note	♪x2	Delay, Analog Delay and Echo can use up to x8. Reverse Delay can use up to x4.
♪	16th note	♪	8th note	♪	Quarter note	:	
♪3	Quarter note triplet	♪3	Half note triplet	♪.	Dotted quarter note	♪x20	

**NOTE**

- The note range actually available depends on the parameter.
- Depending on the combination of tempo setting and selected note symbol, the parameter variation range could be exceeded. In such a case, the value is automatically halved (or set to 1/4 if the range is still exceeded).

Table 2

Setting	Explanation
<b>Off</b>	Frequency does not change.
<b>Up</b>	Frequency changes from minimum to maximum along with the controlling waveform.
<b>Down</b>	Frequency changes from maximum to minimum along with the controlling waveform.
<b>Hi</b>	Frequency changes from patch setting to maximum along with the controlling waveform.
<b>Lo</b>	Frequency changes from minimum to patch setting along with the controlling waveform.

Table 3

Setting	Explanation	Setting	Explanation
<b>Up Saw</b>	Rising sawtooth wave	<b>Tri</b>	Triangular wave
<b>Up Fin</b>	Rising fin wave	<b>TriTri</b>	Squared triangular wave
<b>DownSaw</b>	Falling sawtooth wave	<b>Sine</b>	Sine wave
<b>DownFin</b>	Falling fin wave	<b>Square</b>	Square wave

Table 4

Setting	Explanation	Setting	Explanation
♪	8th note	<b>1 bar</b>	1 measure
♪	Quarter note	<b>2 bars</b>	2 measures
♪	Half note	<b>3 bars</b>	3 measures
♪.	Dotted half note	<b>4 bars</b>	4 measures

Table 5

Setting	Explanation
<b>1</b>	1 semitone lower → original sound
<b>2</b>	Original sound → 1 semitone lower
<b>3</b>	Doubling → detune + original sound
<b>4</b>	Detune + original sound → doubling
<b>5</b>	Original sound → 1 octave higher
<b>6</b>	1 octave higher → original sound
<b>7</b>	Original sound → 2 octaves lower
<b>8</b>	2 octaves lower → original sound

Setting	Explanation
<b>9</b>	1 octave lower + original sound – 1 octave higher + original sound
<b>10</b>	1 octave higher + original sound – 1 octave lower + original sound
<b>11</b>	Complete fifth down + original sound → complete fourth up + original sound
<b>12</b>	Complete fourth up + original sound → complete fifth down + original sound
<b>13</b>	0 Hz + original sound – 1 octave up
<b>14</b>	1 octave up – 0 Hz + original sound
<b>15</b>	0 Hz + original sound – 1 octave up + original sound
<b>16</b>	1 octave up + original sound – 0 Hz + original sound

## Mastering algorithm

- COMP/Lo-Fi module

Type	Parameters							
<b>3Band Comp</b>	<b>Xover Lo</b>	<b>Xover Hi</b>	<b>Sense Hi</b>	<b>Sense Mid</b>	<b>Sense Low</b>	<b>Mix High</b>	<b>Mix Mid</b>	<b>Mix Low</b>
	Compressor that divides signal into 3 bands that can be compressed and mixed separately.							
<b>Lo-Fi</b>	For an explanation of types and parameters, see Stereo algorithm.							

Parameter Explanations

Parameters	Setting range	Explanation
<b>Xover Lo</b>	50 Hz ~ 16 kHz	Adjusts low-to-mid crossover frequency.
<b>Xover Hi</b>	50 Hz ~ 16 kHz	Adjusts mid-to-high crossover frequency.
<b>Sense Hi</b>	0 ~ 24	Adjusts high range compressor sensitivity.
<b>Sense Mid</b>	0 ~ 24	Adjusts mid range compressor sensitivity.
<b>Sense Low</b>	0 ~ 24	Adjusts low range compressor sensitivity.
<b>Mix High</b>	Off, -24 ~ 6	Adjusts high frequency range mix level.
<b>Mix Mid</b>	Off, -24 ~ 6	Adjusts mid frequency range mix level.
<b>Mix Low</b>	Off, -24 ~ 6	Adjusts low frequency range mix level.

# Effect types and parameters 11

- NORMALIZER module

Type	Parameters	
Normalizer	Gain	
	Adjusts COMP/Lo-Fi module input level.	

Parameter Explanations

Parameters	Setting range	Explanation
Gain	-12 ~ 12	Adjusts level.

- 3BAND EQ module

Type	Parameters
3Band EQ	For an explanation of types and parameters, see Mic algorithm.

- DIMENSION/RESO module

Type	Parameters
Dimension Resonance	For an explanation of types and parameters, see Stereo algorithm.

- ZNR module

Type	Parameters
ZNR	For an explanation of types and parameters, see Clean/Crunch, Distortion, Aco/Bass SIM algorithms.

## Send-return effect

- CHORUS/DELAY module

Type	Parameters					
Chorus	LFO Type	Depth	Rate	Pre Delay	EFX Level	
	Mixes a variable pitch-shifted component with the original sound, resulting in full-bodied resonating tone.					
Delay	Time	Feedback	Hi Damp	Pan	EFX Level	Rev Send
	Delay effect with a maximum setting of 2000 ms.					

Parameter Explanations

Parameters	Setting range	Explanation
LFO Type	Mono, Stereo	Sets LFO phase to mono or stereo.
Depth	0 ~ 100	Adjusts effect depth.
Rate	1 ~ 50	Adjusts modulation speed.
Pre Delay	1 ~ 30	Adjusts pre-delay time.
EFX Level	0 ~ 100	Adjusts effect sound level.
Rev Send	0 ~ 30	Adjusts delay sound reverb send level.
Time	1 ~ 2000 ms ♪ (P.127 Table 1)	Adjusts delay time.
Feedback	0 ~ 100	Adjusts feedback amount.
Hi Damp	0 ~ 10	Adjusts amount high-frequency range in delay sound is reduced.
Pan	Left10 ~ Left1, Center, Right1 ~ Right10	Adjusts delay sound panning.

- REVERB module

Type	Parameters					
Hall	Simulates the acoustics of a concert hall.					
Room	Simulates the acoustics of a room.					
	Pre Delay	Decay	EQ High	EQ Low	E.R.Mix	EFX Level
Hall and Room have the same parameters.						
Spring	Simulates a spring reverb.					
Plate	Simulates a plate reverb.					
	Pre Delay	Decay	EQ High	EQ Low	EFX Level	
Spring and Plate have the same parameters.						

Parameter Explanations

Parameters	Setting range	Explanation
Pre Delay	1 ~ 100	Adjusts pre-delay time.
Decay	1 ~ 30	Adjusts reverb time.
EQ High	-12 ~ 6	Adjusts volume of high-frequency range effect sound.
EQ Low	-12 ~ 6	Adjusts volume of low-frequency range effect sound.
E.R.Mix	0 ~ 30	Adjusts mix ratio of early reflections.
EFX Level	0 ~ 30	Adjusts effect sound level.

# Effect patch list 1

## Insert effect

Clean/Crunch algorithm		
No.	Patch name	Description
0	<b>Z CLEAN</b>	ZOOM original unadorned clean sound
1	<b>Z CHORUS</b>	Sound combines "Z CLEAN" with "Chorus" for a clear sound that is great for arpeggios
2	<b>FdClean</b>	Clean-crunch sound of Fender Twin Reverb black panel loved by guitarists of various genres
3	<b>VxCrunch</b>	British crunch sound of a VOX AC30 operating in Class A
4	<b>TWEED</b>	Fender Bassman recreation dry crunch sound with a suitable amount of sustain
5	<b>BgCrunch</b>	Mesa/Boogie MKIII combo amp crunch sound
6	<b>HwLight</b>	Hiwatt Custom 100 from clean to crunch
7	<b>MsCrunch</b>	Marshall 1959 crunch sound becomes cleaner as the guitar volume is reduced
8	<b>HwCrunch</b>	Hiwatt Custom 100 fat crunch sound
9	<b>JM Lead</b>	Compressed lead sound of John Mayer's "Gravity"
10	<b>BS Riff</b>	Brian Setzer's rockabilly sound from the Stray Cats' "Rock This Town"
11	<b>BROTHER</b>	George Benson's unique fat jazz sound is mellow but with an attack
12	<b>Edge</b>	Bright and clean sound with U2 guitarist The Edge's finely calculated delay added
13	<b>ClnStep</b>	Special effect sound that imagines water using "Z CLEAN" and "Step"
14	<b>CutPhase</b>	Phase sound with great attack is perfect for cutting guitar and other playing techniques
15	<b>Ambient</b>	Combination of "Slow Attack" and delay to create an ambient sound
16	<b>Space</b>	Combination of "Reverse Delay" and phaser creates a clean sound with width
17	<b>FdComp</b>	Fender Twin Reverb and compressor clean sound great for cutting guitar
18	<b>Fd Wah</b>	Auto-wah patch with the natural distortion of an FD Combo amp added as the secret ingredient
19	<b>60sSPY</b>	Bizarre sound similar to a 60's spy movie
20	<b>Flower</b>	Combination of phaser and "Vibe" crates a psychedelic worldly sound
21-29	<b>Empty</b>	

Distortion algorithm		
No.	Patch name	Description
0	<b>MsDrive</b>	Marshall 1959 drive sound that follows volume changes and provides outstanding dynamics
1	<b>MdRhythm</b>	Marshall JCM2000 sound for backing parts is very heavy, but still has the unique Marshall character
2	<b>PvRhythm</b>	Peavey 5150 backing part sound with bite that stands out when riffing fast
3	<b>DzRhythm</b>	Diezel Herbert sound for heavy backing parts
4	<b>Recti</b>	Unique powerful thick sound of the MESA/BOOGIE Rectifier
5	<b>FullVx</b>	Sound of Vox AC30 at full volume with room reverb that creates a boxy feeling.
6	<b>TexasMan</b>	Texas blues sound of a Fender Bassman with the volume all the way up
7	<b>BgLead</b>	MESA/BOOGIE MKIII beautiful drive sound great for lead play with long sustain
8	<b>FatOd</b>	Natural overdriven sounds like OD-1 with EQ and can be used backing part and solos
9	<b>TsDrive</b>	Tube Screamer overdrive good for all around use
10	<b>GvDrive</b>	Guv'nor pedal is great for hard rock sound
11	<b>dist+</b>	Drive sound with distortion
12	<b>DS1</b>	DS-1 sound modified with extra low end
13	<b>RAT</b>	Well sustained lead sound of RAT
14	<b>FatFace</b>	Fuzz sound with enhanced FUZZ FACE low end
15	<b>MuffDrv</b>	BIG MUFF high gain sound
16	<b>M World</b>	Shrapnel-style guitarist sound using Metal Zone
17	<b>HOT DRV</b>	Mild driven sound with the tube saturation of HOT BOX tubes
18	<b>Z NEOS</b>	Recreation of modified VOX AC30 creamy crunch sound.
19	<b>Z WILD</b>	ZOOM's original hard overdrive sound with extra boost creates a compressed feeling
20	<b>Z MP1</b>	Hybrid sound from combination of ADA MP1 and Marshall JCM800
21	<b>Z Bottom</b>	ZOOM original high gain sound with rich mids and lows that is great for 80's metal
22	<b>Z DREAM</b>	ZOOM original high gain sound great for leads
23	<b>Z SCREAM</b>	ZOOM original high gain sound with balanced low to high frequencies that cuts through mix
24	<b>LEAD</b>	ZOOM's classic lead sound with strong mid-boost and long sustain necessary for soloing
25	<b>EXT DS</b>	Extreme digital distortion that pushes the limits
26	<b>EC LEAD</b>	Recreation of Eric Clapton's "Layla" lead Fender crunch sound is great sound for guitars with single-coil pickups.
27	<b>JimiFuzz</b>	Jimi Hendrix phase sound simulates Octavia using pitch-shifting
28	<b>DT Slide</b>	Tight tube-amp sound of "Leaving Trunk" by Derek Trucks
29	<b>KC Solo</b>	Nirvana "Smells Like Teen Spirit" sound

# Effect patch list 2

30	<b>Every BG</b>	Buddy Guy's blues sound is dry and overdriven and adds color to any blues lick
31	<b>EVH1959</b>	Early Eddie Van Halen sound
32	<b>BrianDrv</b>	Brian May drive sound recreated using "Z Neos"
33	<b>RitchStd</b>	Sound that Deep Purple's Ritchie Blackmore used recording "Machine Head"
34	<b>Carlos</b>	Smooth sound used by Carlos Santana in album recording recreated using "BG Crunch"
35	<b>PeteHW</b>	Pete Townshend crunch sound using Hiwatt with clean amp turned all the way up for a powerful tone
36	<b>JW Talk</b>	Recreation of the talkbox sound used by Joe Walsh in his "Rocky Mountain Way" solo
37	<b>Kstone</b>	Keith Richards's classic intro sound can be heard in The Rolling Stones' "Satisfaction"
38	<b>RR Mtl</b>	80's Metal sound with distinctive midrange based on the Metal Zone
39	<b>SV LEAD</b>	Stack sound that boldly cuts through the midrange is good for huge guitar solos
40	<b>Monster</b>	Weird tone that mixes a heavy sound with doubling an octave down
41	<b>FatMs</b>	Drive sound with detuning added to thicken the sound is great for power chords and backing parts
42	<b>SlowFlg</b>	Jet sound combining slow attack with flanger
43	<b>DmgFuzz</b>	Psychedelic tone that adds ring modulator to fuzz sound that drastically cuts low frequencies
44	<b>RectiWah</b>	Bold high gain sound with auto-wah and a short delay added
45-49	<b>Empty</b>	

## Acoustic/Bass SIM algorithm

No.	Patch name	Description
0	<b>Ensemble</b>	Gorgeous sound with deep ensemble effect.
1	<b>Delay LD</b>	Lively acoustic guitar sound for lead playing.
2	<b>Chorus</b>	Chorus sound suitable for everything from rhythm guitar to lead guitar.
3	<b>FineTune</b>	Detuning increases sonic depth.
4	<b>Air Aco</b>	Air sound makes it sound like recording with a mic.
5	<b>Standard</b>	Standard bass sound with many uses.
6	<b>CompBass</b>	Bass sound comes alive with compressor and exciter.
7	<b>WarmBass</b>	Bass sound with warm and round feeling.
8	<b>Flanging</b>	Flanging sound covers a lot of ground from 16-beat phrases to melody playing.
9	<b>Auto Wah</b>	Funky bass sound that makes good use of auto wah.
10-19	<b>Empty</b>	

## Bass algorithm

No.	Patch name	Description
0	<b>SVT</b>	Royal rock sound great for finger-picking and flatpicking.
1	<b>BASSMAN</b>	Vintage rock sound for any occasion.
2	<b>HARTKE</b>	Hartke simulation with all the grit and glitter.
3	<b>SUPER-B</b>	Great for guitar unison riffing and solo play.
4	<b>SANS-A</b>	Edgy sound with a strong core that is a good match for flatpicking.
5	<b>TUBE PRE</b>	All-around tube sound.
6	<b>Attack</b>	Compression sound effective for slap and flatpick playing.
7	<b>Wah-Solo</b>	Solo sound with distortion and a touch of wah. Pitch shifting is the secret ingredient.
8	<b>Talk&amp;Cry</b>	Typical special effect that makes a crying sound like a talking modulator.
9	<b>Melody</b>	Chorus sound for melody, solo, chord and harmonic playing.
10	<b>SlapJazz</b>	Basic slap sound in the jazz bass style.
11	<b>Destroy</b>	Smashing sound mixing distortion, pitch shifting and ring modulation.
12	<b>Tremolo</b>	Great match for moody bass lines and chord playing.
13	<b>SoftSlow</b>	Melody or solo play tone that is great for fretless bass.
14	<b>Limitter</b>	Limitter evens out the sound when using a pick.
15	<b>X'over</b>	Flanger sound for picking, typical of the crossover genre.
16	<b>CleanWah</b>	Auto wah sound that has many uses.
17	<b>Exciter</b>	All-around sound with a fresh and transparent character.
18	<b>ClubBass</b>	Sound that simulates the ambience of a small club and is suitable for walking bass lines.
19	<b>DriveWah</b>	Auto wah sound with variable drive that follows picking dynamics.
20-29	<b>Empty</b>	

## Mic algorithm

No.	Patch name	Description
0	<b>Rec Comp</b>	Conventional preamp and compression sound for recording.
1	<b>RoomAmbi</b>	Simulates the ambience of a radio station studio.
2	<b>VocalDly</b>	Delay effect that works best with wet vocals. .
3	<b>Rock</b>	Heavy compression sound for rock vocals

# Effect patch list 3

4	<b>Long DLY</b>	Long delay sound for vocals (2-beat at 120 bpm)
5	<b>InTheBox</b>	This effect seems to put the entire sound into a small box
6	<b>Limiter</b>	Limiter effect that is very useful for recording
7	<b>AG MIC</b>	Preamp tone that is great for recording acoustic guitar
8	<b>AG Dub</b>	Doubling sound that gives a stroke more of a pick feeling
9	<b>12st Cho</b>	Chorus sound for 12-string guitar
10	<b>AG-Jumbo</b>	Increases the apparent body size of an acoustic guitar
11	<b>AG-Small</b>	Reduces the apparent body size of an acoustic guitar
12	<b>AG Lead</b>	Delay sound for acoustic guitar leads
13	<b>Live AMB</b>	Bright reverb sound for acoustic guitar increases live feeling
14	<b>Tunnel</b>	Simulation of tunnel reverb
15	<b>Filter</b>	Filter effect lets you change the sound character during a song, for example.
16	<b>BrethCmp</b>	Fairly strong compressor sound emphasizes breathiness
17	<b>Vib MOD</b>	Crafty vocal sound combines phaser and vibrato
18	<b>Duet Cho</b>	Detuned sound creates an instant duet
19	<b>Ensemble</b>	Fresh ensemble sound great for chorus
20	<b>VocalDub</b>	Conventional doubling sound
21	<b>Sweep</b>	Voice sound with slow phase sweep
22	<b>VoiceFlg</b>	Flanging chorus sound with strong modulation
23	<b>PH Voice</b>	Gimmicky phase sound seasoned with delay
24	<b>VibVoice</b>	Clear-cut vibrato sound
25	<b>FutureVo</b>	A message from the aliens
26	<b>M to F</b>	Transforms male vocals into a female sound
27	<b>F to M</b>	Transforms female vocals into a male sound
28	<b>WaReWaRe</b>	Special effect sounds like a talking spaceman
29	<b>Hangul</b>	Special effect makes Japanese sound like Korean
30-49	<b>Empty</b>	

## Dual Mic algorithm

No.	Patch name	Description	Suggested left/right inputs
0	<b>Vo/Vo 1</b>	For duets	Vocals
1	<b>Vo/Vo 2</b>	Chorus for main vocals	Vocals
2	<b>Vo/Vo 3</b>	For harmony singing	Vocals
3	<b>AG/Vo 1</b>	Creates a story-like character	Acoustic guitar/Vocal
4	<b>AG/Vo 2</b>	Similar to AG/Vo 1 but vocal character different	Acoustic guitar/Vocal
5	<b>AG/Vo 3</b>	Aggressively modifies vocal character	Acoustic guitar/Vocal
6	<b>ShortDLY</b>	Short delay sound with effective doubling	Microphones
7	<b>FatDrum</b>	For drum recording with single point stereo mic	Microphones
8	<b>BothTone</b>	Condenser mic sound for a man on L channel and a woman on R channel	Vocals
9	<b>Condnsr</b>	Simulates condenser mic sound with dynamic mic input	Vocals
10	<b>DuoAttack</b>	Chorus for lead vocals with emphasized attack	Vocals
11	<b>Warmth</b>	Warm sound with prominent midrange	Vocals
12	<b>AM Radio</b>	Simulates AM mono radio	Vocals
13	<b>Pavilion</b>	For narration that captures sound of demonstration at an exposition booth	Vocals
14	<b>TV News</b>	TV newscaster sound	Vocals
15	<b>F-Vo/Pf1</b>	For female pop vocal piano ballads	Vocal/Piano
16	<b>JazzDuo1</b>	Simulates jazz session LP with slightly lo-fi sound	Vocal/Piano
17	<b>Cntmprry</b>	All-around sound with distinct variation	Vocal/Piano
18	<b>JazzDuo2</b>	JazzDuo 1 for male vocals	Vocal/Piano
19	<b>Ensemble</b>	For balance of guitar with strong attack and mellow piano	Acoustic guitar/Piano
20	<b>Enhanced</b>	Emphasizes sound characteristics, optimal for ballads	Acoustic guitar/Vocal
21	<b>Warmy</b>	Moderates overbright tone	Acoustic guitar/Vocal
22	<b>Strum+Vo</b>	Smooth fat sound with midrange enhancement	Acoustic guitar/Vocal
23	<b>FatPlus</b>	Augments weak midrange	Acoustic guitar/Vocal
24	<b>Arp+Vo</b>	Overall solid sound	Acoustic guitar/Vocal
25	<b>ClubDuo</b>	Simulates live sound in small club	Acoustic guitars
26	<b>BigShape</b>	Enhances overall clarity	Acoustic guitars
27	<b>FolkDuo</b>	Fresh and clean sound	Acoustic guitars
28	<b>GtrDuo</b>	Suitable for acoustic guitar duos	Acoustic guitars
29	<b>Bright</b>	Bright, sharp, global feeling	Acoustic guitars
30-49	<b>Empty</b>		

# Effect patch list 4

Stereo algorithm		
No.	Patch name	Description
0	<b>Syn-Lead</b>	For single-note synthesizer lead
1	<b>OrganPha</b>	Phaser for synthesizer/organ
2	<b>OrgaRock</b>	Boomy distortion for rock organ
3	<b>EP-Chor</b>	Beautiful chorus for electric piano
4	<b>ClavFlg</b>	Wah for Clavinet
5	<b>Concert</b>	Concert hall effect for piano
6	<b>Honkey</b>	Honky-tonk piano simulation
7	<b>PowerBD</b>	Gives bass drum more power
8	<b>DrumFlng</b>	Conventional flanger for drums
9	<b>LiveDrum</b>	Simulates outdoor live doubling
10	<b>JetDrum</b>	Phaser for 16-beat hi-hat
11	<b>AsianKit</b>	Changes a standard kit to an Asian kit
12	<b>BassBost</b>	Emphasizes low-frequency range
13	<b>Mono-&gt;St</b>	Gives spaciousness to a mono source
14	<b>AM Radio</b>	AM radio simulation
15	<b>WideDrum</b>	Wide stereo effect for (built-in) drum machine tracks
16	<b>DanceDrm</b>	Reinforces bass frequencies for dance rhythms
17	<b>Octaver</b>	Adds sound one-octave lower
18	<b>Percushn</b>	Gives air, presence, and stereo spread to percussion
19	<b>MoreTone</b>	Increases midrange frequencies, giving more body to distorted guitar
20	<b>SnrSmack</b>	Emphasizes snappiness of snare sound
21	<b>Shudder!</b>	Sliced sound for techno tracks
22	<b>SwpPhase</b>	Phaser with powerful resonance
23	<b>DirtyBiz</b>	Lo-fi distortion using ring modulator
24	<b>Doubler</b>	Doubling for vocal track
25	<b>SFXlab</b>	Gives synthesizer powerful special effect sound
26	<b>SynLead2</b>	Old-style jet sound for synthesizer lead
27	<b>Tekepiko</b>	For sequenced phrases or single-note muted guitar
28	<b>Soliner</b>	Simulates analog strings ensemble
29	<b>HevyDrum</b>	For hard rock drums
30	<b>SM57Sim</b>	Simulation of SM57 mic, which is great for recording electric guitars and other analog instruments.
31	<b>MD421Sim</b>	Simulation of MD421 professional standard mic that is indispensable in broadcasting, recording and live.
32	<b>U87Sim</b>	Simulation of U87, a condenser microphone that sets standards and is used in studios worldwide.
33	<b>C414Sim</b>	Simulation of C414, a famous microphone highly trusted in recording situations.
34	<b>Doubling</b>	Doubles the entire sound for thickness
35	<b>ShortDLY</b>	Delay sound suitable for vocals and field recordings that has a gimmicky effect
36	<b>Lo-Fi</b>	Creates lo-fi sound with a retro feeling as if coming from a radio
37	<b>Limiter</b>	A limiter very effective on band rehearsals and live recording
38	<b>BoostPls</b>	Adds overall sound pressure during recording
39	<b>All Comp</b>	Compressor evens out volume differences between instruments in a band performance, for example
40-49	<b>Empty</b>	



# Effect patch list 5

Mastering algorithm		
No.	Patch name	Description
0	<b>PlusAlfa</b>	Enhances the overall power
1	<b>All-Pops</b>	Conventional mastering
2	<b>StWide</b>	Wide-range mastering
3	<b>DiscoMst</b>	For club sound
4	<b>Boost</b>	For hi-fi finish
5	<b>Power</b>	For a powerful low range
6	<b>Live</b>	Adds a live feel
7	<b>WarmMst</b>	Adds a warm feeling
8	<b>TightUp</b>	Adds a tight feeling
9	<b>1930Mst</b>	Mastering with 1930's sound
10	<b>LoFi Mst</b>	Lo-fi mastering
11	<b>BGM</b>	Mastering for background music
12	<b>RockShow</b>	Gives a rock style mix a live feel
13	<b>Exciter</b>	Lo-fi effect with slight distortion in mid and upper range
14	<b>Clarify</b>	Emphasizes high-end range
15	<b>VocalMax</b>	Brings buried vocals to the foreground
16	<b>RaveRez</b>	Special sweep effect using sharp filter
17	<b>FullComp</b>	Strong compression over full frequency range
18	<b>ClearPWR</b>	Power tuning emphasizes midrange and adds sound pressure and clarity
19	<b>ClearDMS</b>	Enhances clarity and spaciousness
20	<b>Maximizr</b>	Boosts overall sound pressure level
21-29	<b>Empty</b>	

# Effect patch list 6

## Send-return effects

REVERB		
No.	Patch name	Description
0	<b>TightHal</b>	Hall reverb with a hard tonal quality
1	<b>BrgtRoom</b>	Room reverb with a hard tonal quality
2	<b>SoftHall</b>	Hall reverb with a mild tonal quality
3	<b>LargeHal</b>	Simulates the reverberation of a large hall
4	<b>SmallHal</b>	Simulates the reverberation of a small hall
5	<b>LiveHous</b>	Simulates the reverberation of a club
6	<b>TrStudio</b>	Simulates the reverberation of a rehearsal studio
7	<b>DarkRoom</b>	Room reverb with a gentle tonal quality
8	<b>VcxRev</b>	Tuned to enhance vocals
9	<b>Tunnel</b>	Simulates the reverberation of a tunnel
10	<b>BigRoom</b>	Simulates the reverberation of a gym-sized room
11	<b>PowerSt.</b>	Gate reverb
12	<b>BrittHall</b>	Simulates the bright reverb of a concert hall
13	<b>BudoKan</b>	Simulates the reverberation at the Budokan in Tokyo
14	<b>Ballade</b>	For slow ballads
15	<b>SecBrass</b>	Reverb for brass section
16	<b>ShortPla</b>	Reverb with a short release
17	<b>RealPlat</b>	Plate reverb simulation
18	<b>Dome</b>	Reverb simulates playing in a domed-stadium
19	<b>VinSprin</b>	Simulates analog spring reverb
20	<b>ClearSpr</b>	Clear reverb with short reverb time
21	<b>Dokan</b>	Simulates the reverberation of a clay pipe
22-29	<b>Empty</b>	

CHORUS/DELAY		
No.	Patch name	Description
0	<b>ShortDLY</b>	Standard short delay
1	<b>GtChorus</b>	Chorus to enhance weak guitar sound
2	<b>Doubling</b>	Versatile doubling
3	<b>Echo</b>	Showy analog-style delay
4	<b>Delay3/4</b>	Dotted-8th-note delay in sync with tempo
5	<b>Delay3/2</b>	Dotted-quarter-note delay in sync with tempo
6	<b>FastCho</b>	Fast-rate chorus
7	<b>DeepCho</b>	Versatile deep chorus
8	<b>Vocal</b>	Chorus that enhances vocals
9	<b>Deep dB L</b>	Deep doubling
10	<b>SoloLead</b>	Keeps fast phrases tight
11	<b>WarmyDly</b>	Simulates warm analog delay
12	<b>EnhanCho</b>	Enhancer that uses phase-shifted doubling
13	<b>Detune</b>	For instruments with strong harmonics such as a digital electronic piano or synthesizer
14	<b>Natural</b>	Chorus with low modulation suitable for backing parts
15	<b>Whole</b>	Whole-note delay in sync with tempo
16	<b>Delay2/3</b>	Quarter-note triplet delay in sync with tempo
17	<b>Delay1/4</b>	16th-note delay in sync with tempo
18-29	<b>Empty</b>	

## Error message list

If you see a message like “---Error” push the EXIT key. When other errors and messages occur, they will automatically disappear in three seconds.

Message	Meaning	Response
<b>Messages that indicate something is missing</b>		
No Card	There is no card inserted.	Make sure that an SD card is inserted correctly.
No Project	There is no project.	Check that the project has not been deleted or moved to a different place.
No File	There is no file in the project.	Check that the file has not been deleted or stored in a different place.
<b>Messages that are shown frequently</b>		
Reset DATE/TIME	Setting lost because the batteries died.	Set the DATE/TIME again. (See “Setting the date & time” on P.14.)
Low Battery!	Time to change the batteries.	Change batteries or connect the adapter.
Stop Recorder	The function you tried cannot be accessed during playback/recording.	Stop the recorder first, and then try again..
<b>Messages that indicate the object is protected</b>		
Card Protected	The SD card is protected.	Eject the SD card, unlock its write-protection and then insert it again. See “SD card installation” on P.13.)
Project Protected	The project is protected.	Disable using the PROTECT menu. (See “Protecting and selecting projects” on P.91.)
File Protected	This file is read-only, so you cannot write to it.	Disable the read-only status of the file using a computer, for example.
<b>Messages that indicate the capacity or structural limit has been exceeded</b>		
Card Full	The card is full.	Change to a new card or delete unneeded data.
Project Full	No more projects can be saved on the card.	Delete unneeded projects.
File Full	The maximum number of files has been reached.	Delete unneeded files.
<b>Messages that indicate access failure</b>		
Card Access Error	Unable to read or write to the card.	Press <b>EXIT</b> and try the operation again.
Project Access Error	Unable to read or write to the project.	Press <b>EXIT</b> and try the operation again.
File Access Error	Unable to read or write to the file.	Press <b>EXIT</b> and try the operation again.
Card Format Error	This card is not in a format the <b>RB</b> can use.	Change the card format to one that the unit can use.
File Format Error	This file is not in a format the <b>RB</b> can use.	Change the file format to one that the unit can use.
<b>Other error messages</b>		
Card Error	An error of some kind is occurring.	Press <b>EXIT</b> and try the operation again.
Project Error		
File Error		

# Troubleshooting

If you think there is a problem with the operation of the **RS**, check the following tips first.

## Problems during playback

---

- ◆ **No sound, or sound is very weak**
  - Check the connections with the monitoring system and its volume settings.
  - Make sure that status indicators in the mixer section are lit green and that their faders are raised. If a track's indicator is not green, press its key repeatedly until it lights green.
  - Make sure that the [MASTER] status key is not lit and that the [MASTER] fader is raised.

- ◆ **Moving the fader does not affect the volume**

- On channels for which stereo link is turned ON, the fader of the even-numbered channel will have no effect. Either turn stereo link OFF (see P.29), or use the fader of the odd-numbered channel in the pair.

- ◆ **Input signal cannot be heard or is very weak**

- Make sure that the **GAIN** control for that input is turned up.
- Check that the status light is green (playback enabled) and that the fader of the track is raised.

- ◆ **An operation does not work and the message "Stop Recorder" is shown on the display**

- Some operations are not possible while the recorder is operating. Press the **STOP** key to stop the recorder and then conduct the operation.

## Problems during recording

---

- ◆ **Cannot record on a track**

- Make sure that you have selected a track for recording.
- Check whether you have run out of free space on the SD card (see P.111).
- Recording is not possible if the project is protected. Either set "PROTECT" to "OFF" (see P.91), or use a different project.

- ◆ **The recorded sound is distorted**

- Make sure that the input **GAIN** knobs and recording levels are not set too high.
- Lower the faders so that the level meters do not reach 0 dB.
- If EQ gain in the track mixer is set extremely high, the sound may be audibly distorted even if the fader is lowered. Lower EQ gain to a suitable value.

- If an insert effect is applied to an input, check whether the effect output level (patch level) setting is suitable.

## Problems with effects

---

- ◆ **Insert effect is not working**

- Check that the insert effect [INS] icon is shown on the display. If it is not shown, press the **EFFECT** key, then press the **INSERT** soft key and set ON/OFF to On.
- Make sure that the insert effect is inserted in the desired location (See P.23, 45, 46 and 80)

- ◆ **Send-return effect is not working**

- Confirm that the REV or CHO icon is shown on the display. If it is not shown, press the **EFFECT** key, then press the **REVERB** or **CHORUS** soft key and set ON/OFF to On.
- Make sure that the send levels for the tracks are raised (see P.44 and 82).

## Other problems

---

- ◆ **Cannot save a project**

- The project cannot be saved if the project is protected. Set "PROTECT" to "OFF" (see P.91).

- ◆ **Cannot create a new project or copy a project**

- If "Project Full" appears on the display, no more projects can be created on the card. Delete unneeded projects to free up memory.

- ◆ **An error message is shown when attempting to execute a command**

- Please check the error message list (see P.135).

# Specifications

Section		<i>RB</i>	
Recorder	Track count	8 (mono)	
	Maximum number of simultaneous recording tracks	2	
	Maximum number of simultaneous playback tracks	8 audio + metronome	
	Recording format	44.1/48 kHz, 16/24-bit WAV format	
	Maximum recording time	200 minutes/1 GB (mono tracks)	
	Projects	1000	
	Markers	100/project	
	Locator	Hours/minutes/seconds/milliseconds and bars/beats/ticks	
	File editing	Divide, trim	
	Other functions	Punch-in/out (manual, auto), bounce, A-B repeat, undo/redo	
Audio interface	Number of recording channels	2	
	Number of playback channels	2	
	Bit rate	24	
Mixer	Sampling frequency	44.1, 48, 88.2, 96 kHz	
	Faders	9 (mono x 8, master x 1)	
	Track parameters	3-band equalizer, pan (balance), effect send x2, invert	
Effect	Stereo link	Tracks 1/2 ~ 7/8 selectable in pairs	
	Algorithms	8 (CLEAN, DISTORTION, ACO/BASS SIM, BASS, MIC, DUAL MIC, STEREO, MASTERING)	
	Patches	310 insert, 60 send-return	
	Effect modules	7 insert, 2 send	
	Tuner	Chromatic, guitar, bass, open A/D/E/G, D modal	
Rhythm	Voices	8	
	Sound format	16-bit linear PCM	
	Drum kits	10	
	Pads	8 (velocity-sensitive)	
	Precision	48 ppqn	
	Rhythm patterns	511/project	
Sampler	Tempo	40.0 ~ 250.0 BPM	
	Playback formats	44.1/48 kHz, 16/24-bit WAV format	
	Editing functions	Trim, time-stretch	
Hardware	Recording media	SD card (16MB ~ 2 GB), SDHC card (4 ~ 32 GB)	
	Analog-digital conversion	96 kHz 24-bit delta-sigma ADC	
	Digital-analog conversion	96 kHz 24-bit delta-sigma DAC	
	Display	128x64 pixel LCD (with backlight)	
	Inputs	INPUT 1 ~ 8	2 XLR/standard phone combo jacks Input impedance: (Balanced input) 1 K $\Omega$ balanced (2 hot) (Unbalanced input) 50 K $\Omega$ unbalanced (1 with Hi-Z, input impedance 470 k $\Omega$ (Hi-Z on), 2 with phantom power) Input level: -50 dBm < continuous < +4 dBm
		Built-in stereo mic pair	Omnidirectional condenser microphones Gain: -50 dBm < continuous < +4 dBm
	Phantom power	48 V, 24 V	
	Outputs	OUTPUT	TRS phone type (balanced)
		PHONES	Standard stereo phone jack 20 mW x 2 (32 $\Omega$ load)
	S/N ratio	93 dB	
	Control input	FS01	
	USB	Mini-B type (USB 2.0 Hi-Speed): operation as audio interface/control surface and mass storage	
	Power	DC 5V 1A AC adapter (ZOOM AD-17) 3 AA batteries (5.5-hour continuous operation time with backlight on and phantom power off)	
Dimensions	257 mm (W) x 190 mm (D) x 51 mm (H)		
Weight	780 g		

# Index

## A

- A-B REPEAT key . . . . . 7, 8, 38
- A-B repeat function . . . . . 38
- Algorithms . . . . . 80, 118-128, 129-134
- Audio
  - Changing tempo without changing pitch. . . . 68
  - Trimming unnecessary parts . . . . . 70
- Audio interface . . . . . 102, 105
- AUTO PUNCH I/O key . . . . . 7, 8, 33
- Automatic punch-in/out . . . . . 33

## B

- Bit rate . . . . . 97
- Bounce . . . . . 34
- BPM . . . . . 67
- Built-in mic . . . . . 6, 12

## C

- Card reader . . . . . 102, 103
- Changing names . . . . . 57, 88, 94
- Chromatic tuner . . . . . 108
- Connections . . . . . 6, 12, 21
- Contrast . . . . . 109
- Control surface . . . . . 102, 105

## D

- Date and time . . . . . 15
- Deleting data
  - Files . . . . . 95
  - Marks . . . . . 37
  - Projects . . . . . 95
  - SD cards . . . . . 111
- Display
  - Backlight . . . . . 109
  - Contrast . . . . . 109
  - Display . . . . . 9
- Drum kits . . . . . 48, 49, 59

## E

- EFFECT key . . . . . 7, 8, 23, 44-46, 83-89
- Effects
  - Effect modules . . . . . 80, 84, 118-128, 129-134
  - Effect parameters . . . . . 80, 84, 118-128, 129-134
  - Effect types . . . . . 80, 84, 118-128, 129-134
  - Insert effects . . . . . 23, 45, 46, 80, 89
  - Mastering effects . . . . . 46
  - Send-return effects . . . . . 44, 80, 82

- Effect patches . . . . . 80
  - Changing names . . . . . 88
  - Editing . . . . . 84
  - Effect patch list . . . . . 129-134
  - Importing . . . . . 87
  - Initialization. . . . . PDF
  - Saving . . . . . 86
  - Selecting . . . . . 83
- ENTER key . . . . . 7, 8
- EQ . . . . . 42
- EXIT key . . . . . 7, 8

## F

- Fade-in/out . . . . . 71
- FF key . . . . . 7, 8
- Files . . . . . 16, 90, 102
  - Changing names . . . . . 94
  - Copying . . . . . 93
  - Deleting . . . . . 95
  - File names . . . . . 27, 94, 102
  - Importing . . . . . 100, 102, 103
  - Viewing information . . . . . 92
- Firmware version and upgrading . . . . . 114

## G

- GAIN . . . . . 7, 8, 22

## H

- Hi-Z (high impedance) . . . . . 7, 8, 12, 21

## I

- Input gain . . . . . 22
- Input mixer . . . . . 40
- Insert effects . . . . . 23, 45, 46, 80, 89
  - Inserting before the MASTER fader . . . . . 46
  - Insertion points. . . . . 80
  - Using only for monitoring . . . . . 89

## L

- Locate function . . . . . 36
- Loop tracks . . . . . 61
- Loops . . . . . 64

## M

- MARK/CLEAR key . . . . . 7, 8, 36
- MARKER keys . . . . . 7, 8, 36
- Marks . . . . . 36
- Master tracks . . . . . 47
- Mastering effects . . . . . 46
- Manual punch-in/out . . . . . 32
- Metronome . . . . . 20
- Mixdown . . . . . 46, 47

- Mixer . . . . . 40
- Mixing . . . . . 40
- Linking two tracks . . . . . 29
- O**
- Overdubbing . . . . . 28
- P**
- Pads . . . . . 50, 66
- Panning . . . . . 42, 59
- PAN/EQ key . . . . . 7, 8, 24, 29, 42, 44
- Patches . . . . . see Effect patches
- Phantom power . . . . . 12, 21, 112
- PLAY key . . . . . 7, 8
- Playlists . . . . . 98
- Power . . . . . 12, 14, 15, 21, 112
- Changing batteries . . . . . 14
- ON/OFF . . . . . 15
- Setting battery type . . . . . 112
- PROJECT key . . . . . 7, 8, 17, 34, 91-98
- Projects . . . . . 17, 90
- Changing names . . . . . 94
- Copying . . . . . 93
- Creating . . . . . 17
- Deleting . . . . . 95
- Protecting . . . . . 91
- Selecting . . . . . 91
- Sequential playback . . . . . 98
- Viewing information . . . . . 92
- Punch-in/out . . . . . 32
- Automatic punch-in/out . . . . . 33
- Manual punch-in/out . . . . . 32
- Q**
- Quantization . . . . . 66
- R**
- REC key . . . . . 7, 8, 26
- REW key . . . . . 7, 8
- Recording
- Additional tracks . . . . . 28
- Assigning to tracks . . . . . 30
- First track . . . . . 21
- Formats . . . . . 21, 97
- Levels . . . . . 23, 24
- Master track . . . . . 47
- Modes . . . . . 97
- Overdubbing . . . . . 28
- Preparations before recording . . . . . 17
- Times . . . . . 21
- Rhythm functions . . . . . 48-59
- RHYTHM key . . . . . 7, 8, 49-59
- Rhythm pattern tracks . . . . . 48
- Rhythm patterns . . . . . 48, 116-117
- Assigning . . . . . 51
- Changing names . . . . . 57
- Copying . . . . . 55
- Creating . . . . . 52
- Deleting . . . . . 56
- Importing . . . . . 58
- Selecting . . . . . 49
- S**
- Sampler functions . . . . . 60-71
- SD card
- Card reader . . . . . 103
- Changing while the power is on . . . . . 110
- Checking capacity . . . . . 21, 111
- Formatting . . . . . 111
- Installation . . . . . 13
- Send-return effects . . . . . 44, 80, 82
- Sequence data
- Creation . . . . . 73
- Editing . . . . . 76
- Playback . . . . . 78
- Sequence play . . . . . 98
- Shutdown . . . . . 15
- Specifications . . . . . 137
- Stereo links . . . . . 29
- Stereo tracks . . . . . 29
- STOP key . . . . . 7, 8
- Swapping files . . . . . 31
- Switches . . . . . 7, 8
- T**
- Tempo . . . . . 19
- TEMPO key . . . . . 7, 8, 19
- Time signature . . . . . 18, 76
- TOOL key . . . . . 7, 8, 20, 50, 108-114
- TRACK key . . . . . 7, 8, 18, 27, 30, 51, 63-71, 73-78, 100
- Track mixer . . . . . 40
- Track sequencer . . . . . 72-78
- Tracks . . . . . 21, 25, 30, 31, 34, 45, 51, 61, 63, 67
- Assigning . . . . . 30, 51, 63
- Parameters . . . . . 42
- Tuner . . . . . 108
- U**
- USB . . . . . 102
- DAW software operation . . . . . PDF
- Exchanging files with a computer . . . . . 103
- USB key . . . . . 7, 8, 103-106

### **FCC regulation warning (for U.S.A.)**

This equipment has been tested and found to comply with the limits for a Class B digital device, pursuant to Part 15 of the FCC Rules. These limits are designed to provide reasonable protection against harmful interference in a residential installation. This equipment generates, uses, and can radiate radio frequency energy and, if not installed and used in accordance with the instructions, may cause harmful interference to radio communications. However, there is no guarantee that interference will not occur in a particular installation. If this equipment does cause harmful interference to radio or television reception, which can be determined by turning the equipment off and on, the user is encouraged to try to correct the interference by one or more of the following measures:

- Reorient or relocate the receiving antenna.
- Increase the separation between the equipment and receiver.
- Connect the equipment to an outlet on a circuit different from that the receiver is connected to.
- Consult the dealer or an experienced radio/TV technician for help.

For EU Countries



Declaration of Conformity

# **ZOOM**

4-4-3 Kanda-Surugadai, Chiyoda-ku, Tokyo 101-0062 Japan  
Web site: <http://www.zoom.co.jp>