



CS Commercial Solution Series

CSM-21 & CSM-32

Mixer User Guide



This guide does not include all of the details of design, production, or variation of the equipment. Nor does it cover every possible situation which may arise during installation, operation or maintenance.

The information provided in this manual was deemed accurate as of the publication date. However, updates to this information may have occurred.

Trademark Notice: JBL is registered trademark of Harman. Other trademarks are the property of their respective owners.

© 2011 JBL Commercial, 8760 South Sandy Parkway, Sandy, UT 84070 USA. All Rights Reserved.

Contents

Important Safety Instructions	2
Quick Start.....	4
1.0 Introduction	5
1.1 JBL Commercial CSM-21 and CSM-32 Mixer.....	5
1.2 Other Mixer Features.....	5
2.0 Installation	6
2.1 Unpacking	6
2.2 Mechanical Requirements.....	6
2.3 Installing the Mixer	6
2.4 Audio Input and Output Wiring Convention	7
3.0 Rear Panel.....	8
4.0 Front Panel	11
5.0 Knowing Your Mixer	13
5.1 Source	13
5.2 Zones.....	13
5.3 Volume	13
5.4 AutoWarmth™.....	13
5.5 LevelGuard™.....	13
6.0 Setup	14
6.1 Determining Source Priorities.....	14
6.2 Connecting Sources.....	14
6.3 Adjusting Source Gain	14
6.4 Using EQ	14
6.5 Using the Subwoofer Crossover.....	15
6.6 Setting Up AutoWarmth™ Method 1	15
6.7 Setting Up AutoWarmth™ Method 2	15
6.8 Setting Up LevelGuard™	16
6.9 Security Cover	16
Appendix A. Optional Item - CSR Series Remote Controls	17
Appendix B: Block Diagrams.....	19
Appendix C: Specifications.....	20

IMPORTANT SAFETY INSTRUCTIONS



CAUTION

RISK OF ELECTRIC SHOCK
DO NOT OPEN



ATTENTION: RISQUE DE CHOC ELECTRIQUE - NE PAS OUVRI

WARNING: TO REDUCE THE RISK OF FIRE OR ELECTRIC SHOCK DO NOT EXPOSE THIS EQUIPMENT TO RAIN OR MOISTURE

The symbols shown above are internationally accepted symbols that warn of potential hazards with electrical products. The lightning flash with arrowpoint in an equilateral triangle means that there are dangerous voltages present within the unit. The exclamation point in an equilateral triangle indicates that it is necessary for the user to refer to the owner's manual.

These symbols warn that there are no user serviceable parts inside the unit. Do not open the unit. Do not attempt to service the unit yourself. Refer all servicing to qualified personnel. Opening the chassis for any reason will void the manufacturer's warranty. Do not get the unit wet. If liquid is spilled on the unit, shut it off immediately and take it to a dealer for service. Disconnect the unit during storms to prevent damage.

SAFETY INSTRUCTIONS

NOTICE FOR CUSTOMERS IF YOUR UNIT IS EQUIPPED WITH A POWER CORD.

WARNING: THIS APPLIANCE SHALL BE CONNECTED TO A MAINS SOCKET OUTLET WITH A PROTECTIVE EARTHING CONNECTION.

The cores in the mains lead are coloured in accordance with the following code:

GREEN and YELLOW - Earth BLUE - Neutral BROWN - Live

As colours of the cores in the mains lead of this appliance may not correspond with the coloured markings identifying the terminals in your plug, proceed as follows:

- The core which is coloured green and yellow must be connected to the terminal in the plug marked with the letter E, or with the earth symbol, or coloured green, or green and yellow.
- The core which is coloured blue must be connected to the terminal marked N or coloured black.
- The core which is coloured brown must be connected to the terminal marked L or coloured red.

This equipment may require the use of a different line cord, attachment plug, or both, depending on the available power source at installation. If the attachment plug needs to be changed, refer servicing to qualified service personnel who should refer to the table below. The green/yellow wire shall be connected directly to the units chassis.

CONDUCTOR		WIRE COLOR	
		Normal	Alt
L	LIVE	BROWN	BLACK
N	NEUTRAL	BLUE	WHITE
E	EARTH GND	GREEN/YEL	GREEN

WARNING: If the ground is defeated, certain fault conditions in the unit or in the system to which it is connected can result in full line voltage between chassis and earth ground. Severe injury or death can then result if the chassis and earth ground are touched simultaneously.

WARNING FOR YOUR PROTECTION READ THE FOLLOWING:

KEEP THESE INSTRUCTIONS

HEED ALL WARNINGS

FOLLOW ALL INSTRUCTIONS

THE APPARATUS SHALL NOT BE EXPOSED TO DRIPPING OR SPLASHING LIQUID AND NO OBJECT FILLED WITH LIQUID, SUCH AS VASES, SHALL BE PLACED ON THE APPARATUS

CLEAN ONLY WITH A DRY CLOTH.

DO NOT BLOCK ANY OF THE VENTILATION OPENINGS. INSTALL IN ACCORDANCE WITH THE MANUFACTURER'S INSTRUCTIONS.

DO NOT INSTALL NEAR ANY HEAT SOURCES SUCH AS RADIATORS, HEAT REGISTERS, STOVES, OR OTHER APPARATUS (INCLUDING AMPLIFIERS) THAT PRODUCE HEAT.

ONLY USE ATTACHMENTS/ACCESSORIES SPECIFIED BY THE MANUFACTURER.

UNPLUG THIS APPARATUS DURING LIGHTNING STORMS OR WHEN UNUSED FOR LONG PERIODS OF TIME.

Do not defeat the safety purpose of the polarized or grounding-type plug. A polarized plug has two blades with one wider than the other. A grounding type plug has two blades and a third grounding prong. The wide blade or third prong are provided for your safety. If the provided plug does not fit your outlet, consult an electrician for replacement of the obsolete outlet.

Protect the power cord from being walked on or pinched particularly at plugs, convenience receptacles, and the point where they exit from the apparatus.

Use only with the cart stand, tripod bracket, or table specified by the manufacture, or sold with the apparatus. When a cart is used, use caution when moving the cart/apparatus combination to avoid injury from tip-over.



Refer all servicing to qualified service personnel. Servicing is required when the apparatus has been damaged in any way, such as power-supply cord or plug is damaged, liquid has been spilled or objects have fallen into the apparatus, the apparatus has been exposed to rain or moisture, does not operate normally, or has been dropped.

POWER ON/OFF SWITCH: For products provided with a power switch, the power switch DOES NOT break the connection from the mains.

MAINS DISCONNECT: The plug shall remain readily operable. For rack-mount or installation where plug is not accessible, an all-pole mains switch with a contact separation of at least 3 mm in each pole shall be incorporated into the electrical installation of the rack or building.

FOR UNITS EQUIPPED WITH EXTERNALLY ACCESSIBLE FUSE RECEPTACLE: Replace fuse with same type and rating only.

MULTIPLE-INPUT VOLTAGE: This equipment may require the use of a different line cord, attachment plug, or both, depending on the available power source at installation. Connect this equipment only to the power source indicated on the equipment rear panel. To reduce the risk of fire or electric shock, refer servicing to qualified service personnel or equivalent.

If connected to 240V supply, a suitable CSA/UL certified power cord shall be used for this supply.

IMPORTANT SAFETY INSTRUCTIONS

DECLARATION OF CONFORMITY

Manufacturer's Name: JBL Professional
 Manufacturer's Address: 8760 S. Sandy Parkway
 Sandy, Utah 84070, USA

declares that the product:

Product name: JBL CSM-21, CSM-32
 Note: Product name may be suffixed by the EU.

Product option: None

conforms to the following Product Specifications:

Safety: IEC 60065 -01+Amd 1

EMC: EN 55022:2006
 EN 55024:1998
 FCC Part 15

Supplementary Information:

The product herewith complies with the requirements of the:
 Low Voltage Directive 2006/95/EC
 EMC Directive 2004/108/EC.
 RoHS Directive 2002/95/EC
 WEEE Directive 2002/96/EC

With regard to Directive 2005/32/EC and EC Regulation 1275/2008 of 17 December 2008, this product is designed, produced, and classified as Professional Audio Equipment and thus is exempt from this Directive.

Roger Johnsen
 Director, Engineering
 Signal Processing
 8760 S. Sandy Parkway
 Sandy, Utah 84070, USA
 Date: January 28, 2011

European Contact: Your local JBL Sales and Service Office or

Harman Signal Processing
 8760 South Sandy Parkway
 Sandy, Utah
 84070 USA
 Ph: (801) 566-8800
 Fax: (801) 568-7583

U.K. MAINS PLUG WARNING

A molded mains plug that has been cut off from the cord is unsafe. Discard the mains plug at a suitable disposal facility. **NEVER UNDER ANY CIRCUMSTANCES SHOULD YOU INSERT A DAMAGED OR CUT MAINS PLUG INTO A 13 AMP POWER SOCKET.** Do not use the mains plug without the fuse cover in place. Replacement fuse covers can be obtained from your local retailer. Replacement fuses are 13 amps and MUST be ASTA approved to BS1362.

ELECTROMAGNETIC COMPATIBILITY

This device complies with part 15 of the FCC Rules and the Product Specifications noted on the **Declaration of Conformity**. Operation is subject to the following two conditions:

- this device may not cause harmful interference, and
- this device must accept any interference received, including interference that may cause undesired operation.

Operation of this unit within significant electromagnetic fields should be avoided.

- use only shielded interconnecting cables.



If you want to dispose this product, do not mix it with general household waste. There is a separate collection system for used electronic products in accordance with legislation that requires proper treatment, recovery and recycling.

Private household in the 25 member states of the EU, in Switzerland and Norway may return their used electronic products free of charge to designated collection facilities or to a retailer (if you purchase a similar new one).

For Countries not mentioned above, please contact your local authorities for a correct method of disposal. By doing so you will ensure that your disposed product undergoes the necessary treatment, recovery and recycling and thus prevent potential negative effects on the environment and human health.

Quick Start

1. Connect the included JBL power supply to the **POWER** jack on the rear panel of the mixer.
2. On the front panel of the mixer, switch the **POWER** switch to the on position.
3. Connect a stereo audio source to the **SOURCE 1** input. Do not put any audio through the mixer at this time.
4. Turn the **SOURCE 1 GAIN** knob, on the rear panel of the unit, all the way counter-clockwise.
5. Turn the **ZONE 1 LEVEL** knob, on the front panel, all the way counter-clockwise.
6. On the front panel, select source 1 with the **ZONE 1 SELECT** knob.
7. Connect the **ZONE 1** output to your power amplifier. Make sure the amplifier you are connecting to is not powered up while making this connection, this will prevent any nasty pops.
8. Turn on your power amplifier.
9. Turn on your audio source.
10. Slowly turn up the **SOURCE 1 GAIN** knob, on the rear panel, until the **SIGNAL** LED consistently lights green.
11. Now turn up the source level by rotating the **ZONE 1 LEVEL** knob, on the front panel, until you hear audio through your speakers.
12. Adjust the **EQ** until the desired tone is achieved.
13. See page 14 to 15 for setting **AutoWarmth™** and **LevelGuard™**.

1.0 Introduction

1.1 JBL Commercial CSM-21 and CSM-32 Mixer

The JBL Commercial[®] CSM-21 and CSM-32 mixers (hereafter referred to as 'mixer') were specifically designed to provide signal routing flexibility and multiple audio source control. To facilitate this, JBL has equipped the mixers with a wide array of input and output capabilities.

These features allow you to bring the same audio quality – that many of your patrons are used to hearing at home – into your place of business. The CSM mixers have been designed to make them easier to operate than any other product in their class. In reality, the feature set provided by the CSM mixers puts them in a class all by themselves.

CSM-32 mixers provide 3 stereo source inputs and 2 full range stereo zone outputs (with dedicated subwoofer outputs), and are equipped with functional I/O that provide connections for your microphones, fire alarm system, auxiliary devices, and CSR remote controls. CSM-21 mixers provide 2 stereo source inputs, 1 full range stereo zone output (with dedicated subwoofer output), and are equipped with I/O that provide connections for your microphones, fire alarm system, and CSR remote controls. For further information on the CSM's connections and controls, please refer to later chapters in this guide.

JBL's AutoWarmth™ and LevelGuard™ controls give you superb, easy to use equalization and dynamics control. This function allows the signal to be tailored for a wide variety of rooms, taste, and volume requirements.

1.2 Other Mixer Features

The mixers also feature linking capabilities. This is accomplished by connecting standard Cat 5 UTP cables to the mixer's LINK ports.

The linking of multiple mixers provides additional output zones, allowing you to expand the systems output capabilities. Please note that linking mixers does not increase the number of inputs. SOURCE linking allows multiple mixers to share the same input source, eliminating the need for Y-cables. MAIN linking allows multiple mixers to share MIC input, MUSIC MUTE, and DIRECT INPUT functions. When multiple units are linked, there is no master or slave designation. The functions are simply paralleled so that sources, MIC input, MUSIC MUTE, and DIRECT INPUT can be fed to any of the linked mixers.

JBL offers several optional remote controls: CSR-V, CSR-2SV, and CSR-3SV. These remote controls provide remote source selection and/or volume adjustments from within a zone location.

2.0 Installation

Method 1 - Attaching the brackets to the front panel for rack mounting

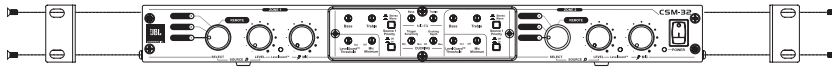

Method 2 - Attaching the brackets to the sides of the unit for wall mounting



2.1 Unpacking

This product was carefully inspected before packing to ensure flawless appearance and operation.

Please unpack and inspect your CSM mixer for any damage that may have occurred during transit. If damage is found, notify the transportation company immediately. Only you can initiate a claim for shipping damage. We will be happy to help as needed. Save the shipping carton as evidence of damage for the shipper's inspection.

We also recommend that you save all packing materials so you will have them if you ever need to transport the unit.

2.2 Mechanical Requirements

We recommend leaving sufficient space around the sides, top, and rear of the mixer to ensure proper ventilation. Forced cooling is not required. The mixer requires a vertical rack space of 1U. Failure to do so may damage the mixer and invalidate the warranty.

2.3 Installing the Mixer

CAUTION: Before you begin, make sure that your mixer is disconnected from the power source and all level controls are turned completely down (counter-clockwise).

To install the mixer, you can use one of the following approaches:

- Install the mixer in a rack enclosure.
 1. Using the original brackets that came with the mixer, align the bracket's holes with the holes on the mixer's chassis.
 2. Fasten the bracket with the provided screws.
 3. Follow steps 1 and 2 to install the remaining bracket(s) to the case, according to your application.
 4. Install the mixer into the cabinet. For further details about rack installation, refer to your cabinet's user guide.
- Install the mixer to the wall. See 'Method 2' in the above figure.
- Stack mixer and amps without using a cabinet.

NOTE: WHEN TRANSPORTING, THE MIXER SHOULD BE SUPPORTED AT BOTH THE FRONT AND BACK.

2.4 Audio Input and Output Wiring Convention

Balanced wiring - The convention for balanced wiring (2-wire plus shield) is:

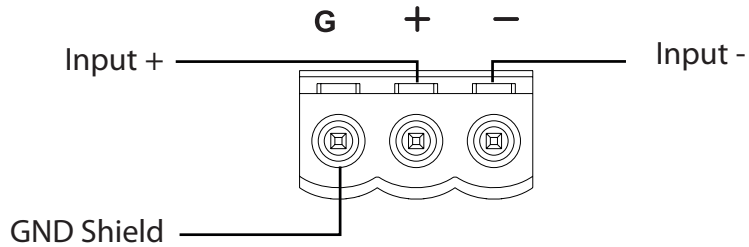

Unbalanced wiring - The convention for unbalanced wiring to the inputs (1-wire plus shield) is:

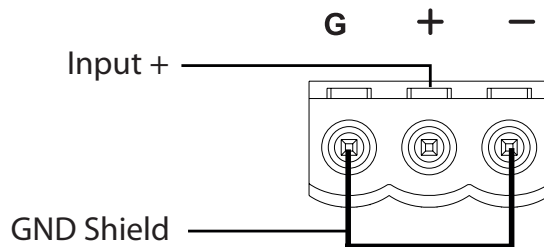

NOTE: THE ABOVE WIRING CONVENTIONS ARE APPLICABLE FOR THE FOLLOWING CONNECTORS: MIC INPUT, DIRECT INPUT, ISO AUX OUTPUT AND ZONE OUTPUT.

3.0 Rear Panel

CSM-32 illustration

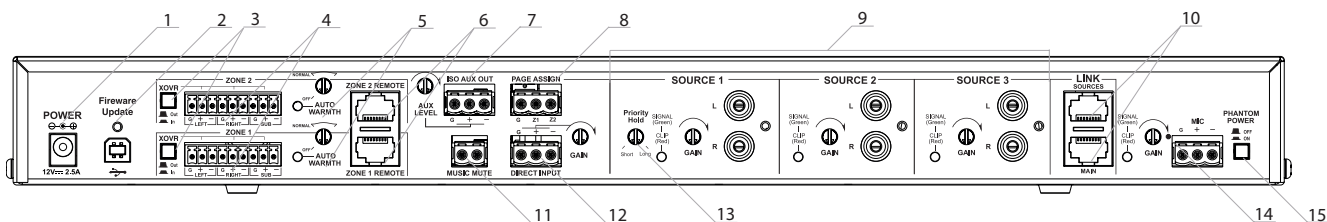

CSM-21 illustration

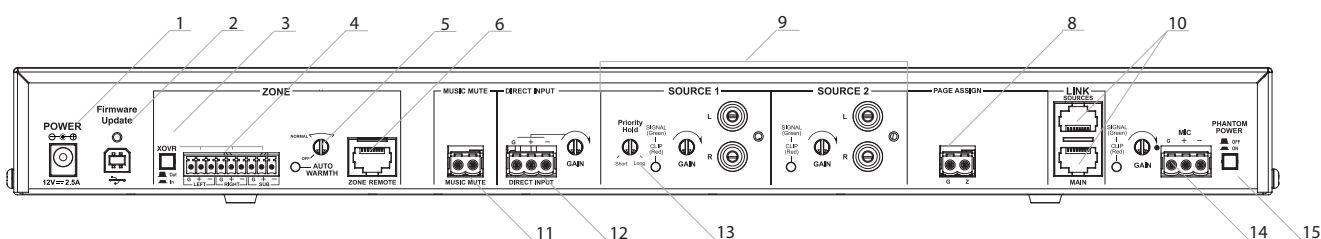

1. Power Supply Input

Connect the included JBL power supply here.

2. Firmware Update

The USB connector allows you to connect your computer to the mixer for updating the firmware.

To retrieve the firmware version of your mixer, observe the LEDs on the rear panel while the mixer boots. The LED in the SOURCE 1 section represents major. The LED in the SOURCE 2 section represents minor. The LED in the SOURCE 3 section represents build. The LED beside the MIC connector represents revision. Each LED will flash green a number of times for the numeral it stands for. The format is “major.minor[.build[.revision]]”. For example, if the first released version is “v1.0.0.0”, when you switch the mixer on, the LED in the SOURCE 1 section will flash green once, and the remaining LEDs will turn red. The unit is then ready for use.

3. Crossover

This switch activates the crossover feature for the left, right, and subwoofer ZONE outputs. When the crossover switch is “in”, the left and right outputs will allow frequencies above 125Hz to pass and the subwoofer output will allow frequencies below 125 Hz to pass. When the crossover is switch is “out”, the left, right, and subwoofer outputs will pass full-range audio to allow the end-user to utilize the built-in crossover functionality on their speakers, if desired. Use this crossover feature if the bass response of your room is too boomy when you are using inexpensive loudspeaker transformers or in conjunction with the subwoofer crossover (see subwoofer crossover section).

4. Zone Output(s)

The mixer ZONE outputs utilize balanced Euroblock connectors. These outputs carry the Left, Right, and Subwoofer signals. Connect these outputs to your power amplifier(s).

5. AutoWarmth™ Indicator and Trim Pot

These indicators flash green when the AutoWarmth function is triggered. This trim pot adjusts the point at which the signal level must drop to before AutoWarmth™ will kick in (referred to as threshold).

6. Zone Remote Jacks

These inputs are for the optional remote controls: CSR-V, CSR-2SV, and CSR-3SV.

7. Isolated Auxiliary Output*

This output sends a transformer isolated mono signal for a music-on-hold system, or for a separate mono auxiliary zone (please note that paging and emergency announcements will not be sent to this zone). The +/- outputs are 600 Ohm transformer isolated so that they can interface to another system (telephone or remote amplifier) without having undesirable ground interaction. The level control adjusts the output level to match a variety of applications.



P11

NOTE: THE P11 JUMPER IS LOCATED ON THE MIXER'S PCB. FROM THE FACTORY, THIS JUMPER IS SET SO THAT THE SOURCE FEEDING THE AUXILIARY OUTPUT IS SELECTED BY THE ZONE 1 SOURCE SELECTOR. IN OTHER WORDS, WHATEVER SOURCE IS SELECTED BY ZONE 1 IS WHAT COMES OUT OF THE AUXILIARY OUTPUT. THIS CAN BE CHANGED TO ALWAYS BE SOURCE 3 BY REMOVING THE INTERNAL JUMPER CAP.

8. Page Assign

This connection allows you to assign pages between output zones (referred to as page steering). This can be accomplished with a simple remote selector switch or can be hard wired if pages are to the same zone every time. Connecting a zone pin (Z1, Z2, or both) to the "G" pin, assigns the page to that zone.

9. Source Inputs

Connect your RCA equipped source signals here.

10. Link Jacks

These inputs allow you to network multiple CSM mixers together. The units are connected by standard Cat 5 UTP cables. For proper operation, the length of the linking cable cannot exceed 2.4 meters.

11. Music Mute

This can be wired to a switch that mutes the background music when pin 2 is connected to pin 1 (ground).

NOTE 1: MUSIC MUTE DOES NOT MUTE THE PAGING MIC AND DIRECT INPUT. IN AN EMERGENCY SITUATION, THE SYSTEM USER MAY NEED TO USE THE PAGING MIC FOR EMERGENCY ANNOUNCEMENTS.

NOTE 2: WHEN THE CSM-21 AND CSM-32 MIXERS ARE LINKED TO PROVIDE AN ADDITIONAL OUTPUT ZONE, MUSIC MUTE WILL BE APPLIED TO OTHER CSM-21 AND CSM-32 MIXERS THROUGH THE LINK CONNECTION.

12. Direct Input

The Direct Input signal is buffered and sent directly to the outputs. This is useful for alarms, emergency pages, or for another priority level of paging. The gain control adjusts the volume of the Direct Input to the Zones.

NOTE: THE DIRECT INPUT REQUIRES A LINE-LEVEL SIGNAL, A MICROPHONE PRE-AMP IS NEEDED TO BOOST A MIC LEVEL SIGNAL BEFORE IT CAN BE RUN INTO THE DIRECT INPUT. Items with * are the controls only found on the CSM-32 mixer.

13. Priority Hold

Priority Hold smoothly adjusts the time it takes for the normal, or ducked, input source to become audible again after the priority source ceases. This allows for compatibility with the many different types of priority sources that exist in business environments.

14. Microphone Input

Connect the paging microphone here.

NOTE 1: LINE LEVEL PAGING OUTPUTS FROM TELEPHONE SYSTEMS MUST BE EXTERNALLY TRANSFORMER ISOLATED AND REDUCED IN VOLUME – DOWN TO MICROPHONE LEVEL – BEFORE CONNECTING THEM TO THIS INPUT.

NOTE 2: MICROPHONE AUDIO WILL NOT BE ROUTED TO OUTPUT ZONES UNLESS PAGE ASSIGN CONTACTS ARE ACTIVE.

15. Phantom Power

This switch allows +48 V phantom power – for condenser microphones – to be turned on and off.

4.0 Front Panel

CSM-32 illustration

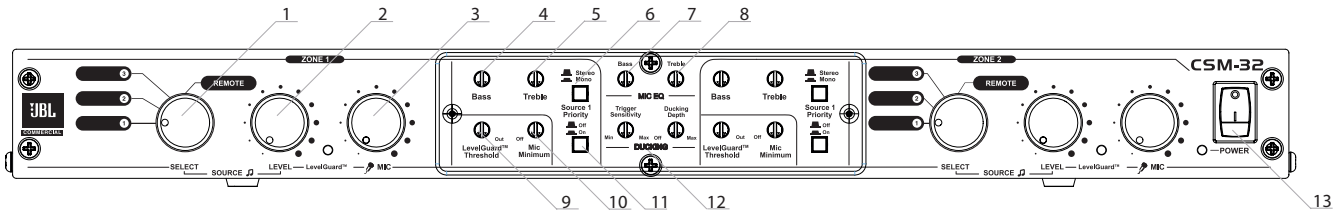

CSM-21 illustration

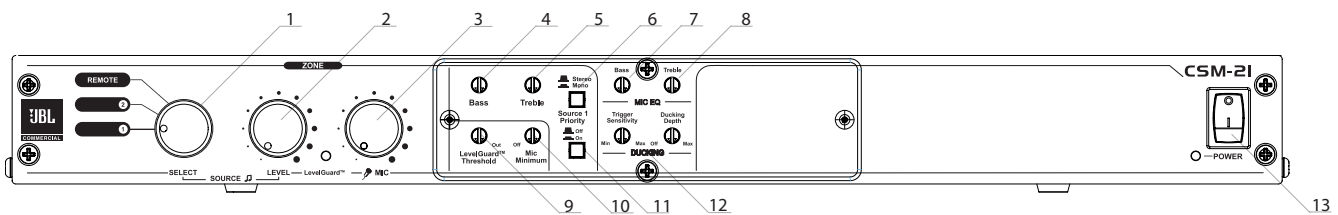

1. Source Selector

The **SELECT** knob selects which source is fed to each zone, or selects the REMOTE option – when using a remote control for source selection. To activate remote source selection control, this control must be set to the **REMOTE** position.

2. Source Level Knob

This **LEVEL** knob increases or decreases the output level of the background music. The range of this knob is: -inf, -48 to +15dB of DSP gain.

3. Microphone Level Knob

This **MIC** level knob increases or decreases the level of the paging mic. The range of the knob is: -inf, -30 to 0dB.

NOTE: THE RANGE OF THE MIC LEVEL KNOB IS DETERMINED BY THE MIC MINIMUM SETTING. WHEN THE **MIC MINIMUM** TRIM POT IS SET TO THE FULL CLOCK-WISE POSITION, THE RANGE OF THE MIC LEVEL KNOB IS LIMITED TO -10 TO 0 dB.

4. Bass Zone EQ

The **Bass** trim pot applies cut or boost to the zone's low frequencies.

5. Treble Zone EQ

The **Treble** trim pot applies cut or boost to the zone's high frequencies.

6. Stereo/Mono Switch

This switch sums the stereo image to mono. This is helpful for accommodating mono input sources, or for feeding stereo input sources into a mono sound system.

7. Bass Mic EQ

The **Bass** trim pot applies cut or boost, by up to +/-6 dB, to the Microphone's low frequencies.

8. Treble Mic EQ

The **Treble** trim pot applies cut or boost, by up to +/-6 dB, to the Microphone's high frequencies.

9. LevelGuard™ Threshold

This LED flashes amber when the LevelGuard™ function has been triggered. This threshold pot adjusts the point at which LevelGuard™ will kick in.

10. Mic Minimum Volume Trim Pot

Sets the desired minimum paging microphone level, enabling the microphone's lowest preferred level to be set. This ensures that the main mic level control cannot be accidentally set too low, thereby preventing a page from being heard from a zone.

11. Source Priority Switch

Selects whether or not Sources 2 and 3 are overridden by the Source 1 input.

12. Ducking

Ducking automatically decreases the level of the background music when a page takes place. Set the Sensitivity control so that the ducking occurs reliably whenever a mic page occurs. Set the depth control to suit the application. Typical ducking would be with the control straight up, letting through some of the background music during a page. You can set the depth for full, minimal, or no ducking of the music, as required.

13. Power Switch

Turns the CSM mixer on/off.

5.0 Knowing Your Mixer

5.1 Source

What is a Source? This is a line-level input signal such as programmed music, CD player, VCR/DVD, satellite feed, tape player, radio, message repeater, or juke box. These sources are then equalized, dynamically controlled, and routed by your selections and priorities on the mixer.

5.2 Zones

What is a zone? This is the area where you wish the signal to be heard. The mixer outputs a stereo or mono signal to your chosen zone. A built-in crossover and subwoofer output allows you to include a subwoofer in each zone, if desired. This allows you to attain the wide bandwidth sound your patrons are used to hearing.

5.3 Volume

What is a good volume? Determining a good volume is a balance of art and science. You need maximum coverage without interfering with the workplace environment or customer comfort and communication.

The mixer gives you the tools you need in the form of AutoWarmth™ and LevelGuard™ to get the best sound quality from the volume that each application requires. Once you have set your volume preferences, AutoWarmth™ and LevelGuard™ help you keep it that way.

5.4 AutoWarmth™

What is AutoWarmth™? In its simplest terms JBL's AutoWarmth™ can be thought of as being similar to the "loudness" control on a home stereo, except its actual functions are considerably more complex. AutoWarmth™ operates on a variable basis, automatically making the proper adjustments to maintain an even tonal perception. This function constantly adjusts for the ear's tendency to hear less low frequencies at low volumes, and more low frequencies at high volumes. AutoWarmth™ automatically ensures full music fidelity at all volumes.

5.5 LevelGuard™

What is LevelGuard™? The LevelGuard™ feature helps keep the volumes of various sources consistent by sensing the level of the incoming audio source and automatically processing the signal to a user selected preference.

6.0 Setup

6.1 Determining Source Priorities

Determining the hierarchy of your sources is easier than it sounds. Generally, it follows this order:

1. Emergency/Alarm (Direct Input with MUSIC MUTE engaged)
2. Pages (Paging Mic)
3. Prerecorded announcements (or another source into SOURCE 1 with Priority engaged).
4. Background music (SOURCE 2 and SOURCE 3)

In this example, your alarms would connect to the Direct Input, your page microphone connects to the MIC Input, prerecorded announcements connect to SOURCE 1, and background music connects to SOURCE 2 and 3.

NOTE: MUSIC MUTE DOES NOT MUTE THE PAGING MIC. IN AN EMERGENCY SITUATION IT IS USUALLY BEST TO KEEP ALL MICROPHONES ACTIVE FOR EMERGENCY ANNOUNCEMENTS.

6.2 Connecting Sources

Connecting your sources is also very simple. Just connect the left and right outputs of your source to the left and right input of the mixer.

6.3 Adjusting Source Gain

Check the input level LEDs, they should light green for continuous signal. Red will flash if the input is too strong. Occasional flashes into the red are not harmful if no distortion is apparent.

6.4 Using EQ

The best determination for needed equalization is to trust your ears. Does the output sound boomy? Reduce the bass setting or engage the high pass filter, this will reduce the bass frequencies. Does it sound dark or muffled? Turn up the treble. Or if it sounds thin or harsh, decrease the treble. Just like the tone controls on a car or home stereo.

6.5 Using the Subwoofer Crossover

When the XOVR switch is engaged, the main speakers are high-passed at 125 Hz and the subwoofer outputs are low-passed at 125 Hz (both using a Butterworth 24 dB per octave filter), forming a full subwoofer crossover. When the XOVR switch is NOT engaged, the main speaker outputs and the subwoofer outputs will all pass a full-range signal.

6.6 Setting Up AutoWarmth™ Method 1

To set up AutoWarmth™, begin by turning the AutoWarmth™ trim pot to the twelve o'clock position. Use this as your "baseline" setting. Now turn up the source volume (located on the front panel) to a typical operating level for that zone. Check the AutoWarmth™ indicator LED, on quieter passages the indicator should flash green. If it does not, start turning the trim pot clockwise until it does. If the indicator is constantly on, turn the trim pot counter-clockwise until it flashes only occasionally.

Then adjust the bass and treble tone controls for that zone. To check the adjustments, turn the volume down to as low as its ever going to be used in that zone and make sure the tone sounds full enough. If not, then turn the AutoWarmth™ trimmer further clockwise to increase its effect. Go back and forth between typical level, low level, and high level. Adjust AutoWarmth™ for the best overall sound at all the compared levels.

6.7 Setting Up AutoWarmth™ Method 2

An alternate method is to turn the AutoWarmth™ trimmer full counter-clockwise. Turn the Source volume (located on the front panel) to the highest volume at which that zone will be operated. Adjust the AutoWarmth™ trimmer clockwise until the green LED just starts to light on musical peaks. Then turn the AutoWarmth™ trimmer back counter-clockwise until it does not light at all. Next turn the zone's level down to normal operating level and adjust the bass and treble controls for that zone, the AutoWarmth LED will light.

With either of these setup methods, AutoWarmth™ should shut off when operating at higher volumes and be lit at both normal and lower volumes.

6.8 Setting Up LevelGuard™

To set up LevelGuard™, begin by turning the LevelGuard™ trim pot to twelve o' clock. Use this as your "baseline" setting. Now turn up the Source volume to the level desired for a particular zone. Check the LevelGuard™ indicator LED, on quieter passages the indicator should be off. On peak volumes the indicator should flash amber. If the indicator is constantly on, turn the trim pot clockwise until it flashes only occasionally. It is useful to set LevelGuard™ so that the LED stays unlit during very low music volume use, flashes on and off during normal volume use, and then lights continuously as the volume increases. For best sound quality, use a combination of LED visual cues and adjustments by ear.

6.9 Security Cover

Once system calibration is complete, affix the security panel over the front panel controls to prevent tampering.

Appendix A. Optional Item - CSR Series Remote Controls

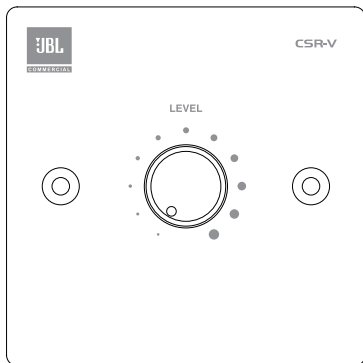

CSR-V

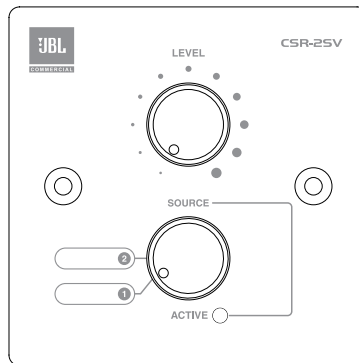

CSR-2SV

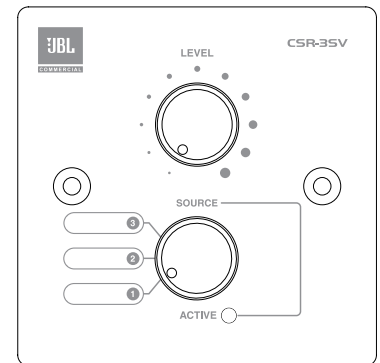

CSR-3SV

Compatibility Between CSR Remote Control and CSM Mixers

Remote Control	Mixer	
	CSM-21	CSM-32
CSR-V	✓	✓
CSR-2SV	✓	✓*
CSR-3SV		✓

*when using two input sources

Optional remote controls are available from JBL to provide source selection and volume control from a remote location other than your mixer.

Selecting Sources

The Source Selection control on the remote control only functions when the Source Selector switch for that zone is set to “REMOTE” on the mixer. When the remote control is active, the green LED on the remote control, below the Source switch (labelled ACTIVE), lights. When this LED is not lit, the remote source control is not operational.

Controlling Volume

The LEVEL on the mixer is ALWAYS operational, regardless whether the Source Selector function is active or not. This remote control is ATTENUATE ONLY.

To set the volume control of the remote control, you can follow these steps:

1. Turn the remote control LEVEL to maximum (full clockwise).
2. Set the volume control on the mixer to the loudest you will ever need the system to be.
3. Turn the remote control LEVEL knob down to a comfortable or typical operating level. Now the volume control on the remote control cannot turn the volume up above what is set on the mixer.

RJ-45 (8-Position)	Color	CSR-V	CSR-2SV/CSR-3SV
Pin 1	White/Orange	+VREF 3.3VDC	+VREF 3.3VDC
Pin 2	Orange	Volume Control	Volume Control
Pin 3	White/Green	Not used	Source Selection
Pin 4	Blue	Not used	LED (+2.8VDC)
Pin 5	White/Blue	Not used	Not used
Pin 6	Green	Not used	Not used
Pin 7	White/Brown	Not used	Not used
Pin 8	Brown	Ground	Ground

Appendix B: Block Diagrams

JBL CSM-21 DSP Signal Diagram

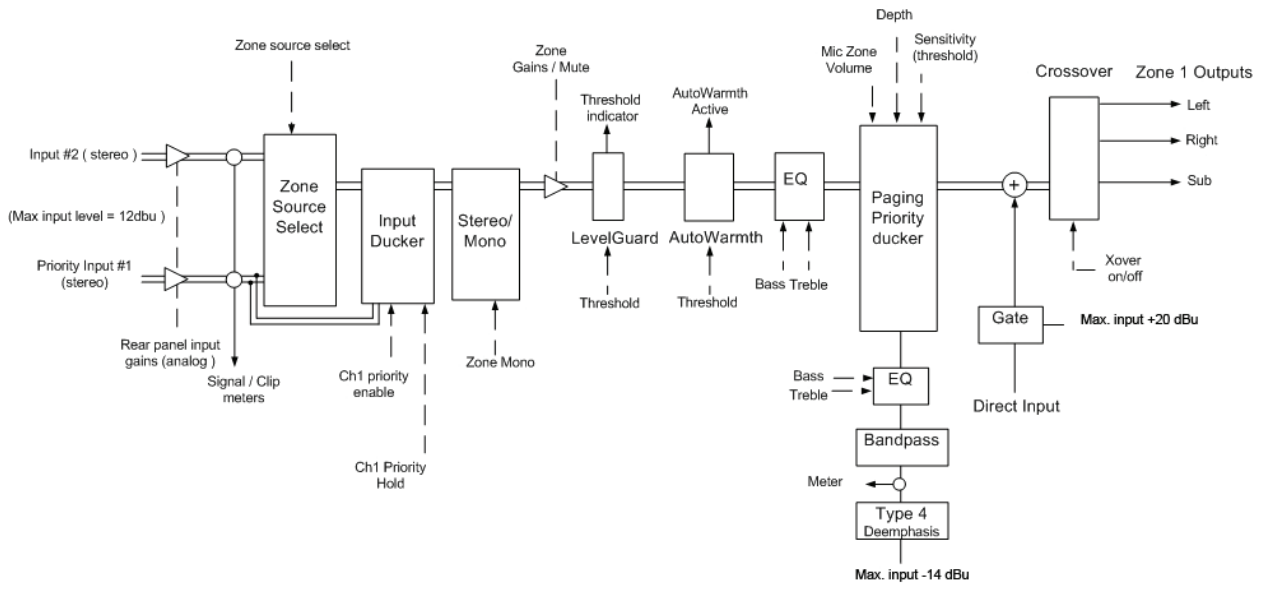

JBL CSM-32 DSP Signal Diagram

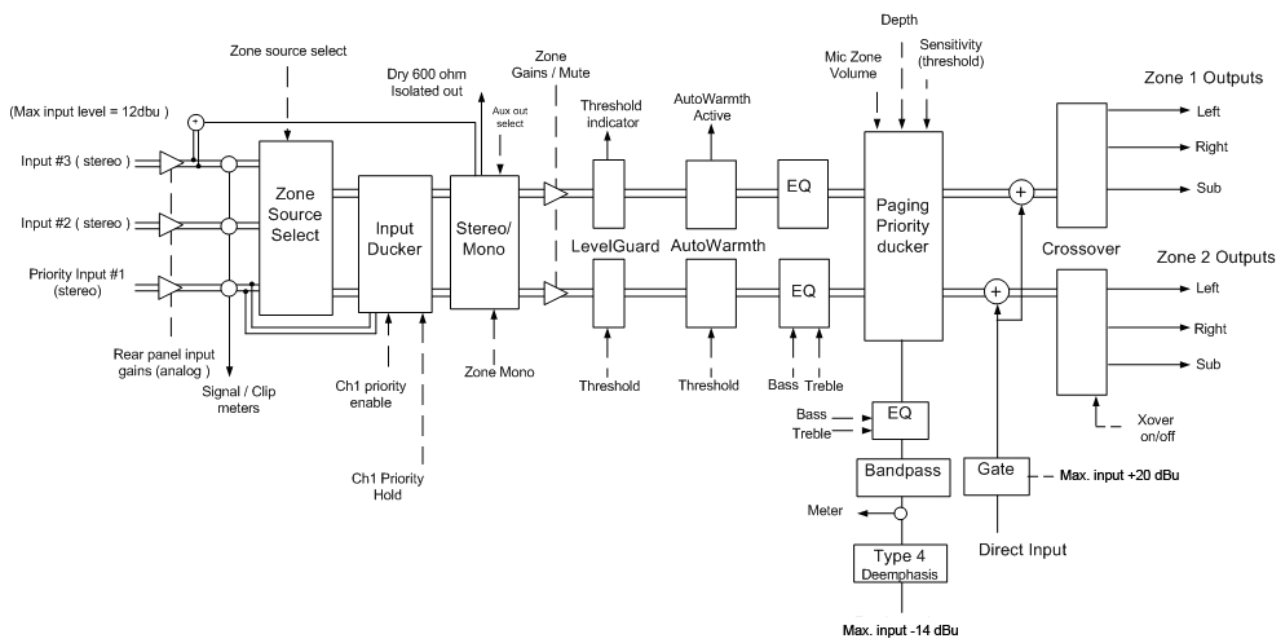

Appendix C: Specifications

LINE INPUTS

Type:	Unbalanced, RCA connector x 2 (stereo) CSM-32 – 3 stereo RCA inputs CSM-21 – 2 stereo RCA inputs
Nominal Sensitivity:	-10dBV
Input Impedance:	20k ohms
Maximum Input:	+12dBu
Equalization:	Bass +/- 10dB @ 80Hz, Treble +/- 10dB @ 8kHz, 6dB/Octave Shelf

MIC INPUT

Type:	Balanced, 5.08mm, Euroblock connector
Input Impedance:	2k ohms
Noise:	EIN <117 dB, 150 ohm, DSP band-limited 120Hz-8kHz, BW24
Maximum Input:	+20dBu
Equalization:	Bass +/-6dB @ 250Hz, Treble +/-6dB @ 2kHz, 6dB/Octave Shelf
CMRR:	>40dB, typically >55dB @ 1kHz
Pre-Amp Gain:	+30dB to +60dB adjustable
Phantom Power:	+48VDC, 10mA

ZONE OUTPUTS

Type:	Balanced, 3.5mm, Euroblock connectors; Each Zone = Left, Right, Sub CSM-32 – 2 Zone Outputs CSM-21 – 1 Zone Output
Output Impedance:	120 ohm balanced
Max. Output Level:	+20dBu
XOVR specifications:	“Out” Left, Right: 20Hz-20kHz Sub: 20Hz-20kHz (mono summed) “In” Left, Right: 125Hz High-Pass (BW24) Sub: 125Hz Low-Pass (BW24)

REAR PANEL LED INDICATORS

Source Inputs:	Signal Present LED (turns on at -20dBu) Signal Clip LED (turns on at +10dBu)
Mic Input:	Signal Present LED (turns on at -20dBu) Signal Clip LED (turns on at +18dBu)

SYSTEM PERFORMANCE

Frequency Response:	20Hz-20kHz, +/- 0.1dB
Dynamic Range:	104dB, A-Weighted, 20Hz-20kHz
Converter Type:	Mic input implements dbx Type IV™ Conversion System
Sample Rate:	48kHz
Crosstalk:	>75dB
THD+N:	0.005% typical at +4dBu, 20Hz-20kHz, 0dB gain

MISCELLANEOUS

Direct Input:	Balanced, 5.08mm Euroblock connector
Input Impedance:	10k ohms
Maximum Input:	+20dBu
Frequency response:	20Hz-20kHz
Isolated Aux Output:	600 ohm, balanced, transformer isolated, 250Hz – 8kHz, +/- 1dB, max level +10dBu (CSM-32 only)
Music Mute:	2-pin 5.08mm Euroblock connector Connecting the pins mutes all Source inputs, does not mute Mic input
Page Assign:	CSM-21: 2-pin 5.08mm Euroblock connector CSM-32: 3-pin 5.08mm Euroblock connector Connecting zone pin to ground assigns page to that respective zone
Source Link:	RJ45, CAT3 or higher. Max length 2.4m
Main Link:	RJ45, CAT3 or higher. Max length 2.4m

GENERAL

Power Consumption:	10W
Power Requirements:	100-240V Thermal fuse in external transformer
Dimensions (WxHxD):	19.0" x 1.8"(no feet) x 7.0" (including knobs and connectors)
Weight:	5.3 lbs (2.4kg)



JBL Commercial
8760 South Sandy
Parkway
Sandy, UT 84070
USA
(801) 566-8800

Part Number: 18-6401-A Issue: 06/11