

DDR-31+

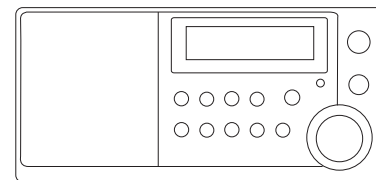

GB

Version 1

Contents

<i>Controls</i>	2-4	<i>Bass control</i>	29
<i>Mains operation</i>	5	<i>Mute function</i>	30
<i>Operating your radio</i>	6	<i>Display backlight dimmer</i>	30
<i>Selecting a station – DAB</i>	7	<i>Factory reset</i>	31
<i>Display modes – DAB</i>	8	<i>Software version</i>	32
<i>Finding new stations - DAB</i>	9	<i>USB socket for software upgrade</i>	33
<i>Secondary services – DAB</i>	9	<i>Headphone socket</i>	33
<i>Manual tuning – DAB</i>	10	<i>Auxiliary input socket</i>	33
<i>Dynamic Range Control (DRC) – DAB</i>	11	<i>Line Out socket</i>	34
<i>Operating your radio – FM auto-tune</i>	12	<i>Cautions</i>	34
<i>Manual tuning - FM</i>	12	<i>Specifications</i>	35
<i>Display modes – FM</i>	13	<i>Circuit features</i>	35
<i>Presetting stations - DAB and FM</i>	14		
<i>Recalling a preset station - DAB and FM</i>	14		
<i>Scan sensitivity setting</i>	15		
<i>Stereo / Mono setting – FM</i>	16		
<i>Clock display</i>	17		
<i>Setting the time and the date manually</i>	18-21		
<i>Setting the alarm times</i>	22-25		
<i>Stop the alarm</i>	26		
<i>Canceling alarms</i>	26		
<i>Sleep timer</i>	27		
<i>EQ function</i>	28		
<i>Treble control</i>	29		

Controls (front)

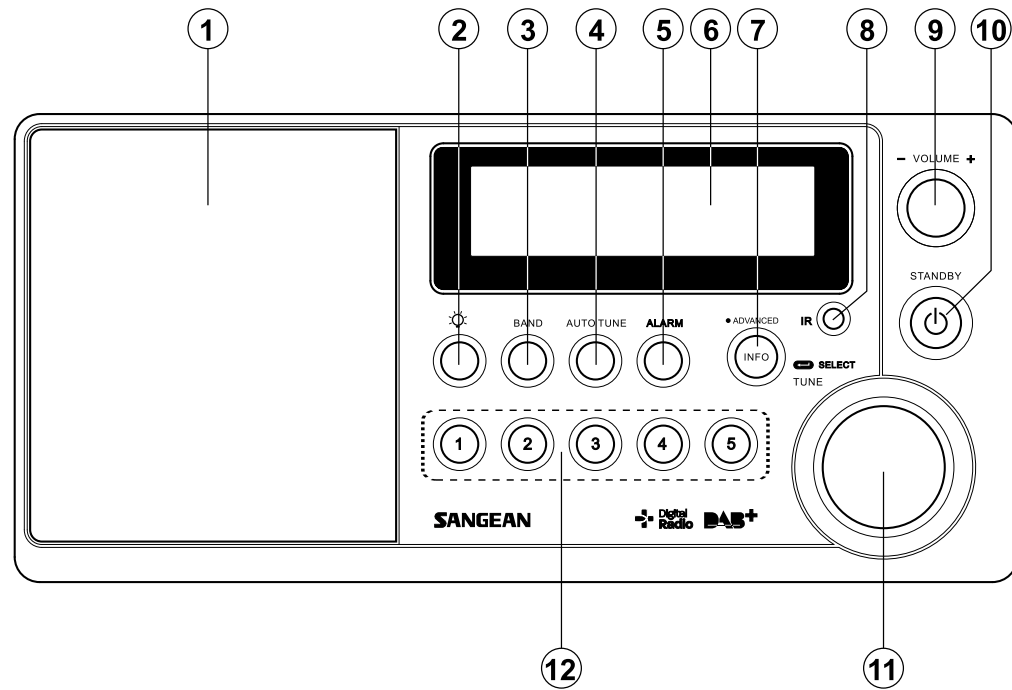

1. Loudspeaker
2. Light button
3. Band button
4. Auto tune button
5. Alarm button
6. LCD display

7. Advanced / INFO button
8. Infra-red sensor
9. Volume knob
10. On / StandBy button
11. Tuning control / Select knob
12. Preset buttons

GB

Controls (rear)

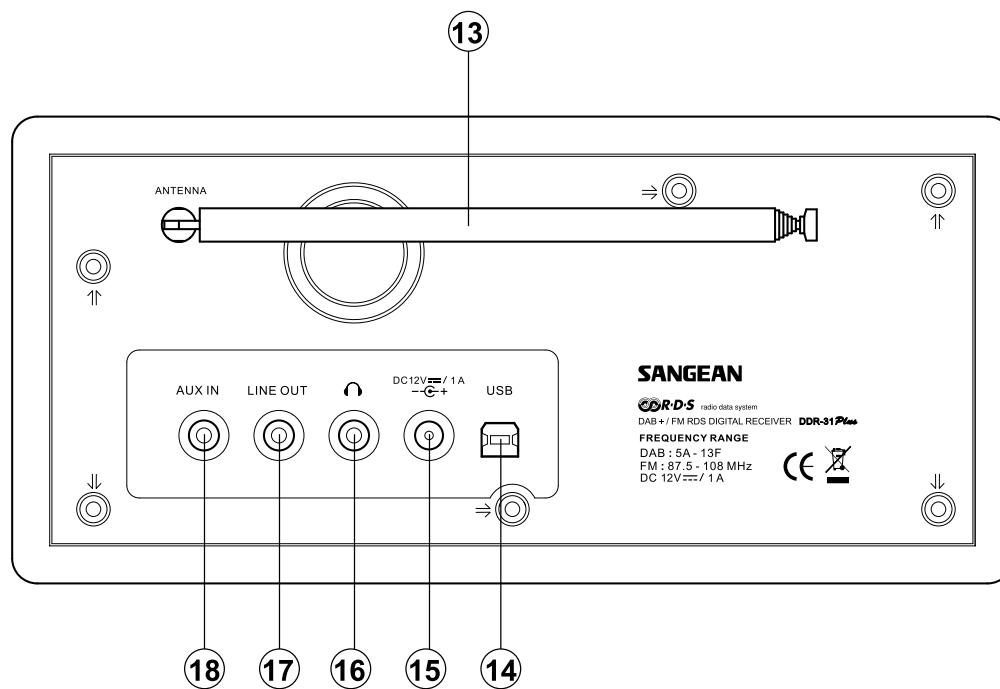

- 13. Telescopic aerial for DAB+ / FM
- 14. USB socket for software upgrade
- 15. DC power in socket

- 16. Headphone socket
- 17. Line Out socket
- 18. Auxiliary input socket

Controls (remote control)

- A. On / Standby button
- B. Mute button
- C. Preset button
- D. Select button
- E. Tuning Down button
- F. Advanced button
- G. Auto tune button
- H. Band / Auxiliary input Mode button
- I. Alarm button
- J. Info button
- K. EQ button
- L. Tuning Up button
- M. Sleep button
- N. Volume Up or Down buttons
- O. Dimmer button

Note:

For the sake of clarity, the instructions for the use of the controls throughout this instruction manual show the buttons on the remote control. The buttons on the clock radio can be used if you prefer.

Note:

The operations described below for the panel are the same as the operations for the remote control.

1. Rotate the Tuning Knob on the panel is the same as pressing the Tuning Up or Down buttons on the remote control.
2. Press and hold in the Tuning Knob on the panel is the same as pressing and release the Select button on the remote control.
3. Press and hold in the Info button on the panel is the same as pressing and release the Advanced button on the remote control.
4. Rotate the Volume Knob on the panel is the same as pressing the Volume Up or Down buttons on the remote control.

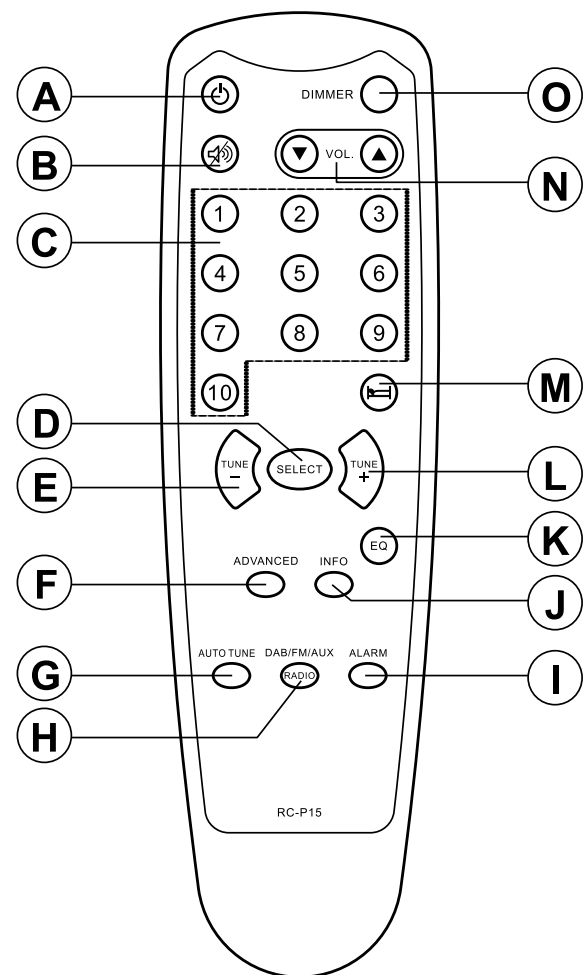

GB

Mains operation

1. Place your clock radio on a flat surface.
2. Plug the mains lead into the Socket located on the rear of your clock radio ensuring that the plug is pushed fully into the socket.
3. Plug the other end of the mains lead into a wall socket and switch on the wall socket.

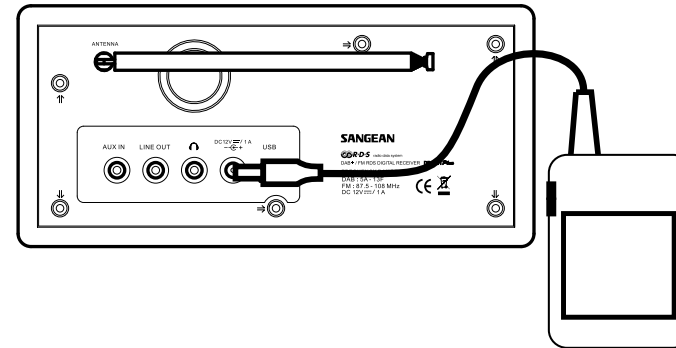

Operating your radio - DAB

1. Fully extend the telescopic aerial. Fully extend the telescopic aerial located on the rear of your clock radio. Place the telescopic antenna so that it is as vertical as possible extending either above or below the radio.
2. Insert the adaptor plug into the DC socket located on the rear of your clock radio. Plug the adaptor into a standard mains outlet. The display will show "Welcome to Digital Radio" for a few seconds and then the display will show "Time is not set". (If the radio has been used before the radio is to find a clock radio stations. After a while the current time will appear on the display.)
3. Press and release the On / StandBy button to switch on your clock radio.
4. During the scanning process, the lower line of the display shows a bar-graph indicating progress of the scan.
5. If the radio has been used before, the last used station will be selected.
6. When the scanning is completed the first station (in numeric-alpha order 0...9...A....Z) will be selected.
7. If this is the first time that the radio has not been used, then the first station in the list of stations found during scanning will be played. The display will show the station name on the display.
8. If the station list is still empty after the Auto tune your clock radio will display "No DAB Station".
9. If no signals are found it may be necessary to relocate your clock radio to a position giving better reception.

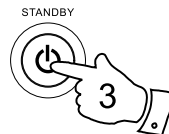

Welcome to
Digital Radio

00:00:00
Time is not set

No DAB Station

GB

Selecting a station - DAB

1. The top line of the display shows the name of the station currently selected.
2. Press the Tuning Up or Down buttons to scroll through the list of available stations. Stop pressing the Tuning Up or Down buttons when you find the station that you wish to hear.
3. Press and release the Select button to select the station. The display may show "Now Tuning" while your clock radio finds the new station.
4. Adjust the Volume Up or Down buttons to the required settings.

Note:

If there is no sound after selecting a station, press and release the Info button to check scrolling text, the display continues to show "Service not available" it may be necessary to relocate your clock radio to a position giving better reception.

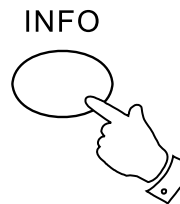
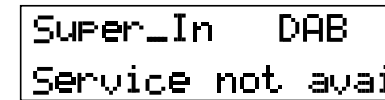
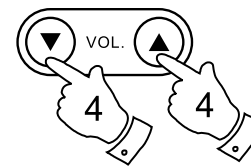
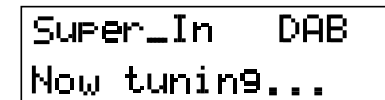
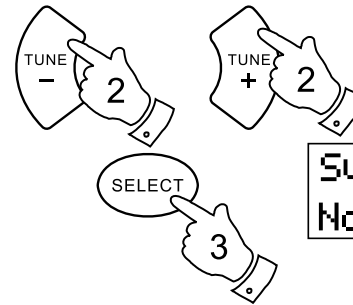
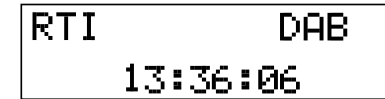

Display modes – DAB

Your clock radio has a range of display modes:-

1. Press and release the Info button to cycle through the various modes.

- | | |
|--------------------------|--|
| a. Scrolling Text | Displays scrolling text messages such as artist/track name, phone in number etc. |
| b. Signal Strength | Displays a graph showing the signal strength for the station being received. |
| c. Program Type | Displays the type of station being listened to e.g. Pop, Classic, News etc. |
| d. Multiplex Name | Displays the name of DAB multiplex to which the current station belongs. |
| e. Channel & Frequency | Displays the frequency and channel of the DAB multiplex for the station listened to. |
| f. Bit Rate & Audio Type | Displays the digital bit rate & audio type for the station being listened to. |
| g. Time | Displays the current time. |
| h. Date | Displays the current date. |



- | | |
|---|--|
| a | |
| b | |
| c | |
| d | |
| e | |
| f | |
| g | |
| h | |

GB

Finding new radio stations – DAB

As time passes new stations may become available. To find new stations proceed as follows:-

1. With the radio switched on and in DAB mode, press and release the Auto Tune button. The display will show “Scanning...” and your clock radio will perform a scan of the Band III DAB channels. As new radio stations are found the station counter on the right-hand side of the display will increase and the radio stations will be added to the list stored in the radio.

AUTO TUNE



Secondary services - DAB

1. Certain radio stations have one or more secondary services associated with them. If a station has a secondary service associated with it the display will show “>>” next to the station name on the station list. The secondary service will then appear immediately after the primary service as you press the Tuning Up or Down buttons to clockwise.

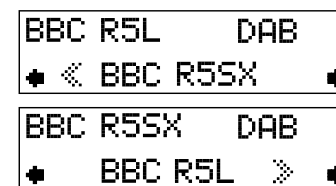
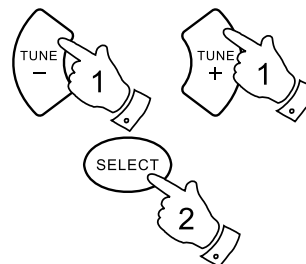

2. Press and release the Select button to select the station.

3. When the secondary service shuts down, your clock radio will automatically switch back to the main radio station (or primary service) if it is available.

Manual Tuning – DAB

Manual tuning allows you to tune your clock radio to a particular DAB frequency. Any new stations found will be added to the station list. Note that DAB stations are located in the range of 5A-13F.

1. With the radio switched on and in DAB mode, press and release the Advanced button, the display shows “Manual tune”.
2. Press and release the Select button to enter manual tuning mode.
3. Press the Tuning Up or Down buttons to select the desired DAB channel.
4. Press and release the Select button to tune to the chosen frequency. If a signal is present then the channel number and the first part of DAB multiplex name will be displayed. Any found stations will be added to the stored list in the radio.
5. Press and release the Select button again to return to the normal DAB tuning mode.

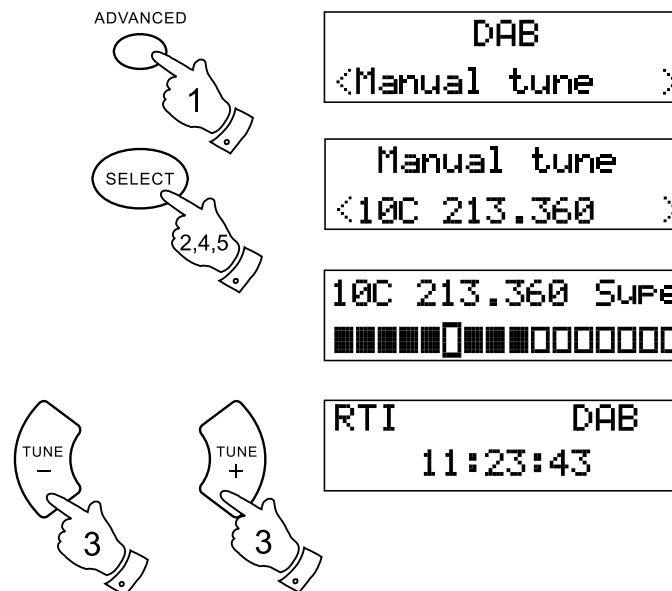

GB

Dynamic Range Control (DRC) - DAB

The DRC facility can make quieter sound easier to hear when your radio is used in a noisy environment.

There are three levels of DRC compression,

- DRC off: DRC is switched off, broadcast DRC will be ignored.
- DRC high: DRC is set as sent by broadcaster.
- DRC low: DRC level is set to 1/2 that sent by broadcaster.

With the radio switched on and in DAB mode,

1. Press and release the On / StandBy button to switch on your clock radio.
2. Press and release the Advanced button. The display will show "Manual tune."
3. Press the Tuning Up or Down buttons until the display shows "DRC".
4. Press and release the Select button to enter the adjustment mode.
5. Press the Tuning Up or Down buttons to select the required DRC setting (the default is off).
6. Press and release the Select button to confirm the setting.
7. Press and release the Info button, the display will return to normal tuning mode.

Note:

Not all DAB broadcasts are able to use the DRC function. If the broadcast does not support DRC, then the DRC setting in the radio will have no effect.

```
DRC *
<DRC off >
```

```
Manual tune
<DRC high >
```

```
100 213.360 Sure
<DRC low >
```

```
DAB
<Manual tune >
```

```
DAB
<DRC >
```

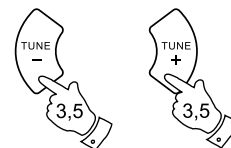

Operating your radio – FM auto-tune

1. Fully extend the aerial located on the rear of your clock radio. Place the antenna so that it is as straight as possible, extending either above the radio.
2. Press and release the On / StandBy button to switch on your clock radio.
3. Press and release the Band button to select the FM band.
4. Press and release the Auto Tune button, display will show scanning and your clock radio will scan from low frequency to high frequency (or in the direction last scanned). It will stop automatically when it finds a station of sufficient strength.
5. After a few seconds the display will update. The display will show the frequency of the signal found. If the signal is strong enough and there is RDS data present then the radio will display the station name.
6. To find additional stations, press and release the Auto Tune button as before.
7. To scan the FM band in an upward or downward direction (low frequency to high frequency or high frequency to low frequency), i.e. clockwise or counter-clockwise, press and hold down the Tuning Up or Down buttons for 0.5 seconds and then release the Tuning Up or Down buttons to tune to a station, and then press and release the Auto Tune button, the frequency will continue following the last Tuning Up or Down buttons in an upward or downward direction.
8. Adjust the Volume Up or Down buttons to the required setting.
9. To switch off your clock radio press and release the On / Standby button.

Manual tuning – FM

1. Press and release the On / StandBy button to switch on your clock radio.
2. Press and release the Band button to select the FM band. Carefully extend the telescopic aerial fully for FM reception.
3. Press the Tuning Up or Down buttons to tune to a station. With each click of the control the frequency will change up or down by 50 kHz.
4. When the waveband end is reached the radio will recommence tuning from the opposite waveband end.
5. Set the Volume Up or Down buttons to the desired settings.
6. To switch off your clock radio press and release the On / StandBy button.

Display modes – FM

In FM mode the bottom line of the display can be set to any of the following display options:-

1. Press and release the Info button to cycle through each of the options.

- | | |
|--------------------------------|---|
| a. Time | Displays the current time. |
| b. Date | Displays the current date. |
| c. Radio text (Scrolling text) | Displays scrolling text messages such as artist / track name, phone in number, etc. |
| d. Program type | Displays type of station being listened to e.g. Pop, Classic, News, etc. |
| e. Program Name / Frequency | Displays frequency of the station being listened to. |
| f. Audio mode | Display shows Stereo or Mono. |

Note:

Your clock radio will display “NO Radio Text” on the lower line of the display if there is no scrolling text available and “NO PTY” if there is no programme type information.

INFO



- | | |
|---|------------------------------|
| a | BBC R2 FM
12:02 |
| b | BBC R2 FM
16-06-2009 |
| c | BBC R2 FM
The latest news |
| d | BBC R2 FM
Pop Music |
| e | BBC R2 FM
88.10MHz |
| f | BBC R2 FM
Stereo |



Presetting stations - DAB and FM

There are 5 memory presets on the panel for each of the 2 wavebands. However, There are 10 memory presets on the remote control for each of the 2 wavebands.

1. Press and release the On / StandBy button switch on the radio.
2. Tune to the required station as previously described.
3. Press and hold down the required Preset button until the display shows e.g. "Preset 1 stored". The station will be stored under the chosen preset button. Repeat this procedure for the remaining presets.
4. Stations stored in preset memories may be overwritten by following the above procedure.



Recalling a preset station - DAB and FM

1. Press and release the On / StandBy button to switch on the radio.
2. Select the required waveband by pressing the Band button.
3. Momentarily press and release the required Preset button, your radio will tune to the station stored in preset memory.

GB



Scan sensitivity setting

Your radio will normally scan for FM broadcasts which are strong enough to give good reception. However, you may wish the Scan function to also be able to find weaker signals, possible from more distant radio transmitters. Your radio includes a local / distant option for the Scan function in the FM band.

1. Switch on your radio and select FM band by pressing Band button.
2. Press and release the Advanced button. The display will show "FM scan zone".
3. Press and release the Select button to enter FM Scan Zone set.
4. Press the Tuning Up or Down buttons to switch between Local and Distant options. The distant option will allow the radio to find weaker signals when scanning.
5. Press and release the Select button to confirm your selection.
The Local or Distant setting is stored in the radio and remains in force until changed or until a Factory Reset.

Note:

The local setting causes the radio to ignore weak signals.

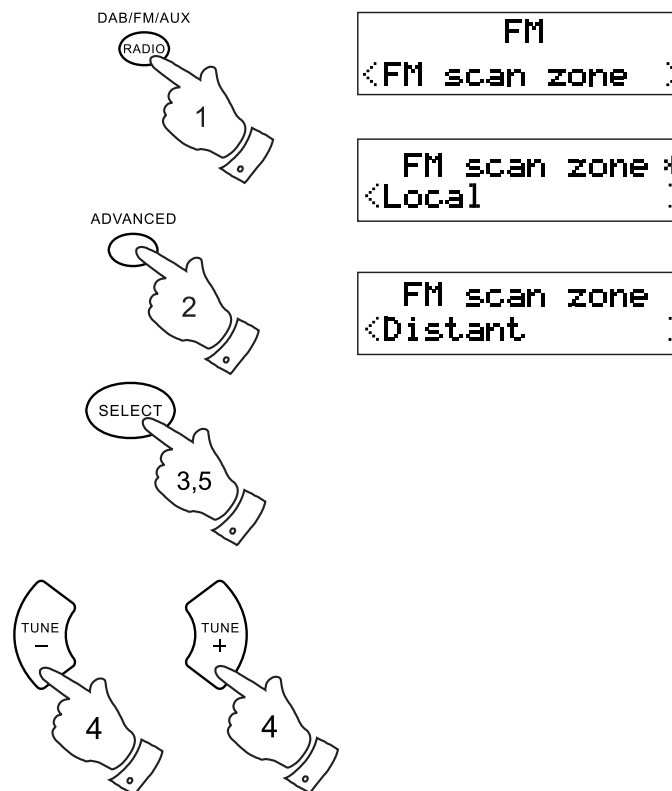

Stereo / Mono setting – FM

Your clock radio will play stereo broadcasts in stereo (via headphones) so long as the received signal is of adequate strength. However, as a stereo signal becomes weaker, the audio signal will become poorer. It may be preferable to force the radio to play the station in mono in order to reduce the level of audio noise.

1. Switch on your clock radio and tune to the required FM radio station by pressing the Band button.
2. Press and release the Advanced button. The display will show "FM scan zone".
3. Press the Tuning Up or Down buttons to switch "Mono override" then press and release the Select button to enter the Mono override menu. Display will show "Override off" if the radio is in Auto stereo mode.
4. Press the Tuning Up or Down buttons and then Press and release the Select button to switch on the Mono override. While the setting is stored, the radio will play the current station in mono whether listening via headphones or the loudspeaker. Mono override is a temporary setting and is applied to the currently tuned station only. It is cancelled automatically by tuning to another radio station.
5. If you wish to cancel Mono override while listening to the currently tuned radio station, press and release the Advanced button then following above procedures to enter Mono override menu to allocate Mono override On. Press the Tuning Up or Down buttons to allocate Mono override off. Press the Select button to switch off the Mono override. The radio will then play the current station in stereo through headphones if the signal is sufficiently strong.

Note:

You can also directly press and release the Select button to switch on the Mono or Stereo mode on the remote control or the panel.

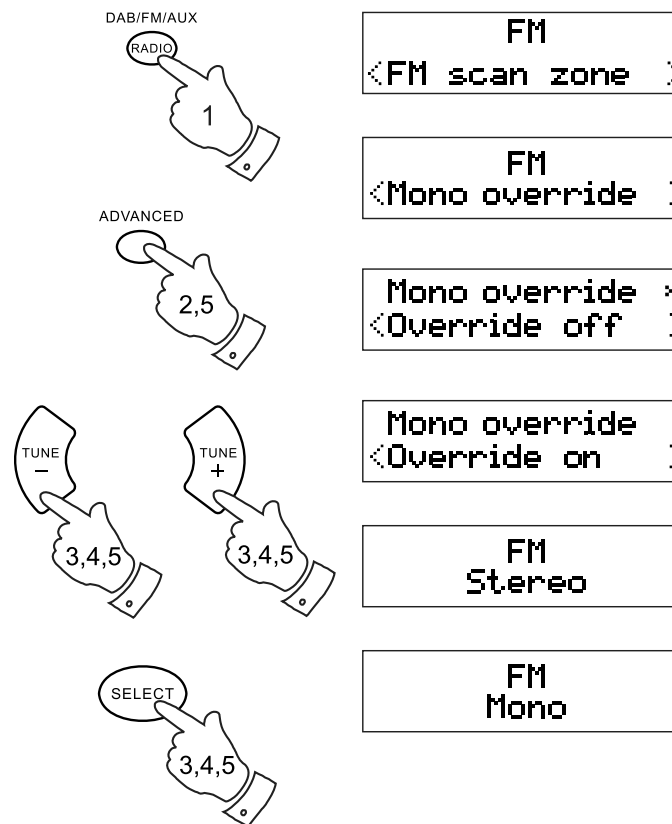



Clock display

1. When your clock radio is in Standby mode, the display normally show the current time, date, month and year.
2. During StandBy mode the clock will receive updates from the last station tuned to before entering StandBy mode. When in StandBy mode your radios clock will automatically track Summer / Winter time changes.



Setting the time and the date manually

The DDR-31 Plus will automatically set its clock when tuned to a DAB radio station or to an FM station which is broadcasting the time via RDS.

If the clock cannot be set using DAB or FM radio then you will need to set the time and the date manually before the alarm function can be used. The time and the date may be set while the unit is in StandBy mode or while playing.

If it becomes necessary to set the time and the date manually, please follow these steps:

1. Press and release the On / StandBy button to switch on the radio.
2. Select the required waveband by pressing the Band button.
3. Press and release the Advanced button. The display will show "FM scan zone".
4. Press the Tuning Up or Down buttons to switch "System".
5. Press and release the Select button to enter the Time menu.
6. Press and release the Select button to enter the "Set 12/24 hour" menu.
7. Press the Tuning Up or Down buttons to switch the "Set 12/24 hour".
8. Press and release the Select button to confirm your selection. The 12/24 hour setting is stored in the radio.
9. Press the Tuning Up or Down buttons to switch the "Set Time/Date".
10. Press and release the Select button to enter the "Set Time/Date" menu.

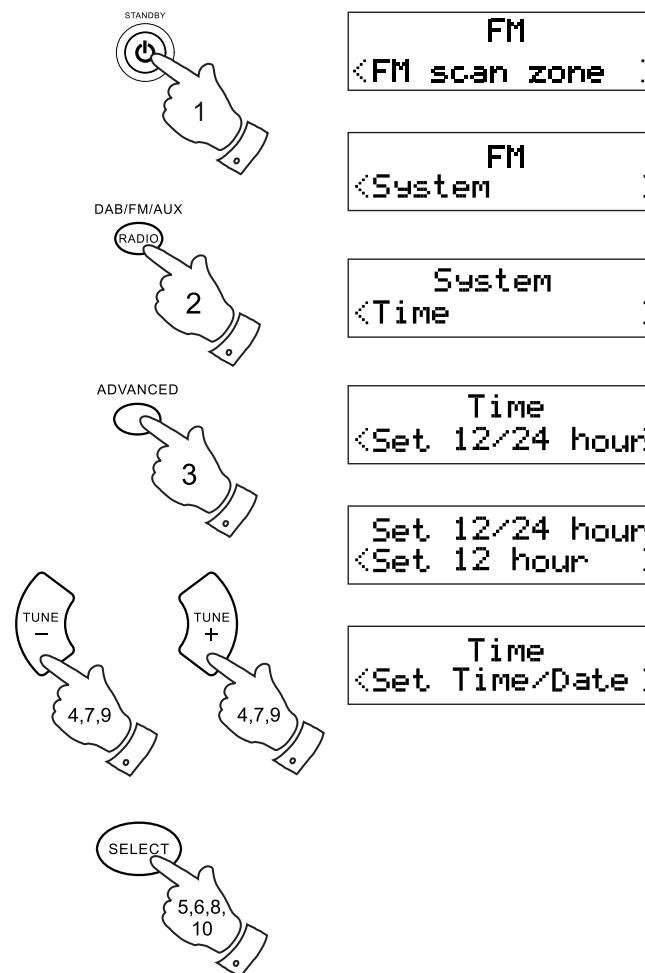

GB

11. The hour digits on the display will flash. Press the Tuning Up or Down buttons to change the hour digits as needed.
12. Press and release the Select button to confirm the hour setting.
13. The minute digits on the display will flash. Press the Tuning Up or Down buttons to change the minute digits as needed.
14. Press and release the Select button to confirm the minutes setting.
15. The day digits on the display will flash. Press the Tuning Up or Down buttons until the desired day is set.
16. Press and release the Select button to confirm the day setting.
17. The month will flash on the display. Press the Tuning Up or Down buttons until the desired month is set.
18. Press and release the Select button to confirm the month setting.
19. The year number will flash on the display. Press the Tuning Up or Down buttons until the desired year is set.

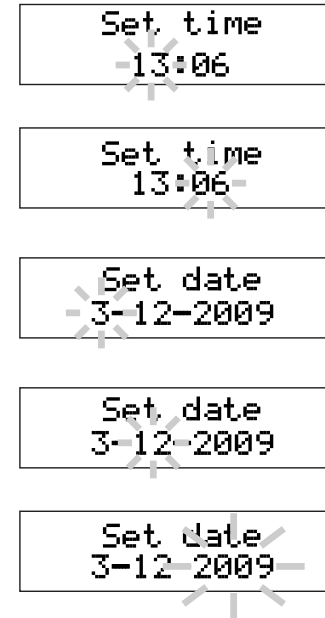

20. Press and release the Select button to confirm the year and to complete the clock and date setting. The Time/Date setting is stored in the radio.

21. Press the Tuning Up or Down buttons to switch "Auto update".

22. Press and release the Select button to enter the "Auto update" menu.

23. Press the Tuning Up or Down buttons to switch the "Auto update" mode. There are four "Auto update" modes as Update from Any, Update from DAB, Update from FM and No update.

24. Press and release the Select button to confirm your selection. The Auto update setting is stored in the radio.

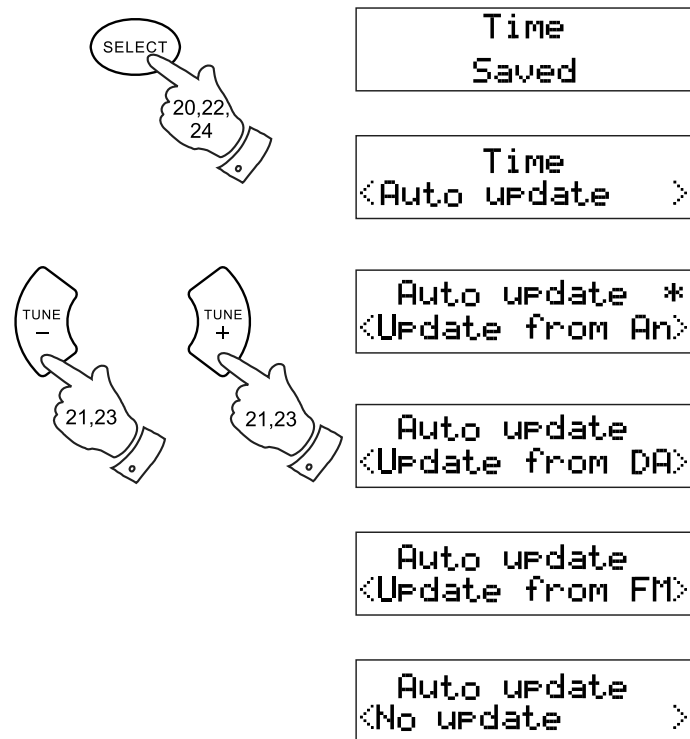

GB

25. Press the Tuning Up or Down buttons to switch "Set date format".

26. Press and release the Select button to enter the "Set date format" menu.

27. Press the Tuning Up or Down buttons to switch the "Set date format" mode. There are two "Set date format" modes as DD-MM-YYYY and MM-DD-YYYY.

28. Press and release the Select button to confirm your selection. The Auto update setting is stored in the radio.

29. The display will revert to the display for the previous operating mode.

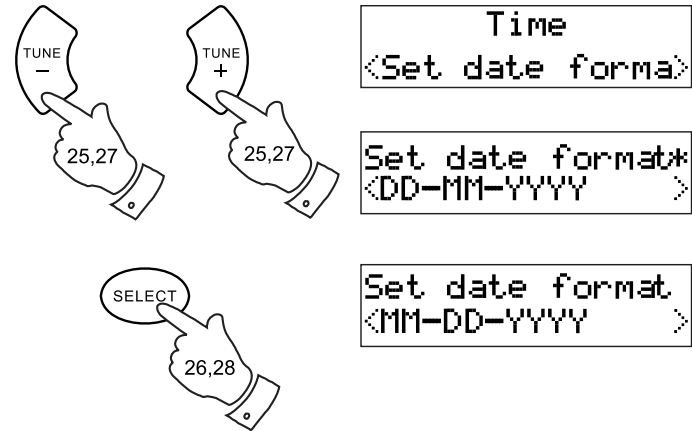

Setting the alarm times

Your clock radio has two alarms which can be set to wake you either radio or buzzer alarm. Each alarm can be set to sound once, daily, on weekdays or at weekends.

Note:

If no buttons are pressed for 10 seconds, your clock radio will exit the alarm set up.

1. The alarm can be set either the radio is on or standby.
2. Press and release the Alarm button to switch the "Alarm 1 Setup" or the "Alarm 2 Setup" menu.
3. Press and release the Select button to enter the "Alarm 1 Wizard" or "Alarm 2 Wizard" menu.
4. The hour digits on the display will flash. Press the Tuning Up or Down buttons to change the hour digits as needed.
5. Press and release the Select button to confirm the hour setting.
6. The minute digits on the display will flash. Press the Tuning Up or Down buttons to change the minute digits as needed.
7. Press and release the Select button to confirm the minutes setting. The alarm times setting is stored in the radio.
8. The duration digits on the display will flash. Press the Tuning Up or Down buttons until the desired duration is set. There are five "Duration" options as 15, 30, 45, 60, and 90 minutes.



Alarm 1 Setup

Alarm 1 Wizard
On time 06:00



Alarm 1 Wizard
On time ~~06:00~~

Alarm 1 Wizard
On time 06:00

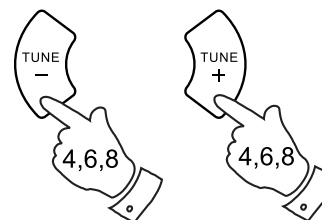

Alarm 1 Wizard
Duration ~~90~~

GB

9. Press and release the Select button to confirm your selection.
The alarm duration setting is stored in the radio.

10. The source digits on the display will flash. Press the Tuning Up or Down buttons until the desired source is set. There are three "Source" options as FM, Buzzer and DAB.

11. If the alarm source buzzer is chosen, press and release the Select button to confirm your selection. The alarm source setting is stored in the radio.

12. The day digits on the display will flash. Press the Tuning Up or Down buttons until the desired the alarm day is set. There are four "Alarm day" options as Once, Weekends, Weekdays, and Daily.

- Once: will sound at one time only.
- Weekends: will sound only at weekends.
- Weekdays: will sound only on weekdays.
- Daily: will sound everyday.

13. Press and release the Select button to confirm your selection.
The alarm day setting is stored in the radio.

14. If the alarm source DAB or FM is chosen, press and release the Select button to confirm your selection. The alarm source setting is stored in the radio.

15. The station digits on the display will flash. Press the Tuning Up or Down buttons until the desired station is set. There are two "Station" options as the last listened station and the preset stations.

16. Press and release the Select button to confirm your selection.
The alarm station setting is stored in the radio.

Note:

If there is no preset station, the display will show only last listened.



17. The alarm day digits on the display will flash. Press the Tuning Up or Down buttons until the desired the alarm day is set. There are four "Alarm day" options as Once, Weekends, Weekdays, and Daily.

18. Press and release the Select button to confirm your selection. The alarm day setting is stored in the radio.

19. The lower line of the display will show a bar-graph indicating sound level of the alarm. Press the Tuning Up or Down buttons until the desired volume is set.

Note:
The default minimum volume level of the alarm is one.

20. Press and release the Select button to confirm your selection. The alarm volume setting is stored in the radio.

21. The alarm setup digits on the display will flash. Press the Tuning Up or Down buttons to switch the alarm setup digits as needed. There are two "Alarm Setup" options as On and Off.

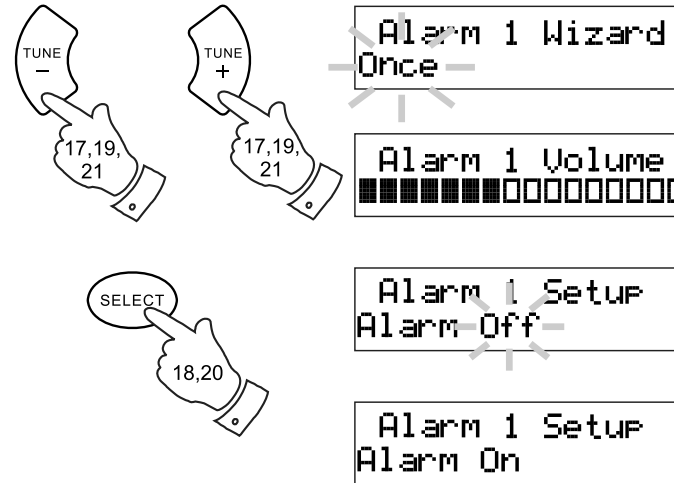

22. Press and release the Select button to confirm the alarm setup setting. The alarm setup setting is stored in the radio.

23. The display will show "Alarm saved" and will appear alarm symbol  indicating the alarm is set.

24. Press the Tuning Up or Down buttons to select Off. The display will show "Alarm saved" but the display will not appear alarm symbol.

Note:

If the above alarm setting procedures are not completed, the display will show "Alarm Not saved". You may have to start over above procedures again.

25. The alarm has now been set and the unit will revert to the previous display. The alarm symbol indicator (alarm 1 or 2) will show on the display.

Note:

You can also press and hold down the Alarm button to switch the "Alarm 1 Setup" or the "Alarm 2 Setup" menu, when your clock radio is in Standby mode. Then press and release the Select button to enter the "Alarm 1 Wizard" or "Alarm 2 Wizard" menu as above described.

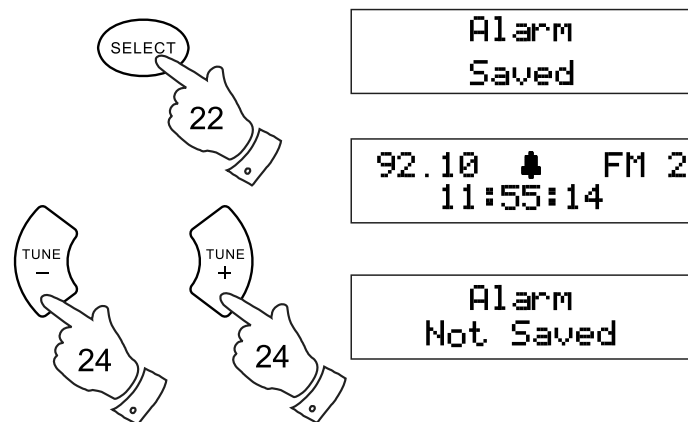

Stop the alarm

When alarm is active, press the On / StandBy button to stop the alarm (radio and buzzer).

Note:

When alarm is active, press any button (except the On / StandBy button) to enter into "5 minutes Snooze Mode".

Canceling alarms

1. Following above alarm setting procedures to allocate alarm On or Off, select OFF by pressing the Tuning Up or Down buttons then press Select button to cancel the alarm setting. The alarm symbol will disappear from the display.

Note:

You can also follow the below procedures of the canceling alarms.

1. The alarm can be set either the radio is on or standby.
2. If the radio is switched on, press and release the Alarm button to switch the "Alarm 1 Setup" or the "Alarm 2 Setup" menu.
3. Press the Tuning Up or Down buttons to select Off.
4. Press and release the Select button to confirm the alarms setting off. The alarm setup setting is stored in the radio. The display will show "Alarm saved" but the display will not appear alarm symbol.

Note:

You can also press and release the Alarm button to switch on or off the "Alarm 1 Setup" or the "Alarm 2 Setup", when your clock radio is in Standby mode. Then press and release the Select button to switch on or off the "Alarm 1 Setup" or the "Alarm 2 Setup", when your clock radio is in Standby mode.

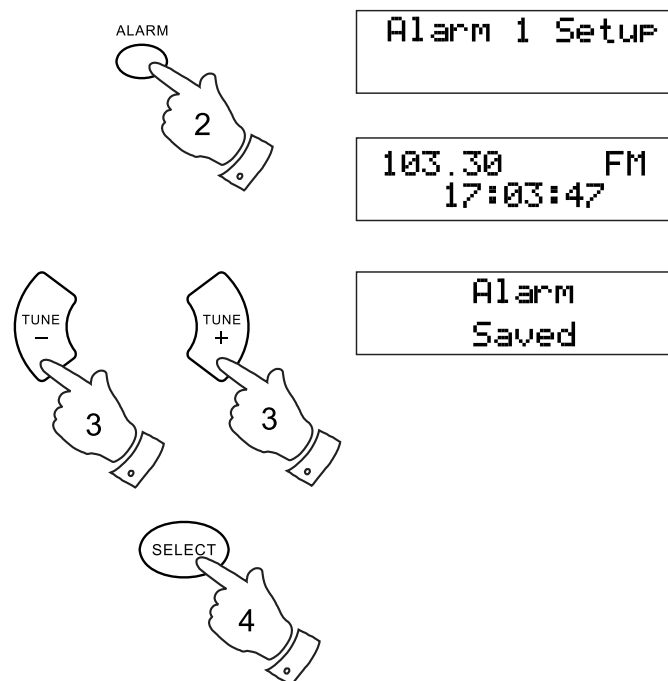

GB

Sleep timer

Your clock radio can be set to turn off after a preset time has elapsed. The sleep timer can be adjusted between 15 and 90 minutes in 15 minutes increments (except 75 minutes). Ensure your clock radio is switched on.

1. Press and hold down the Sleep button until desired sleep time appears on the display. Release the Sleep button.
2. The display will show an "S" indicating sleep timer is set.
3. Press and release the Sleep button to monitor remaining sleep timer time.
4. To cancel sleep timer, simply press the On / Standby button.

Note:

The Sleep button is on the remote control only. The unit does not has a Sleep button.

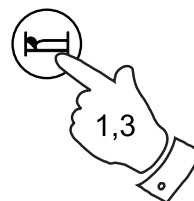

Set sleep time
90 minutes

103.30 S FM
17:17:45

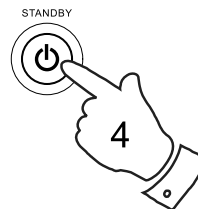

Sleep
remain 12 min

EQ function

The sound on your sound system can be adjusted to suit your personal taste for the material that you are listening to. The DDR-31 plus has six preset equalizer modes. Alternatively, you may set the treble and bass levels to your own preferences.

1. Press and release repeatedly the EQ button to cycle through the various modes until desired equalizer mode appears on the display. Release the EQ button.

- Flat - no tone modification is applied
- Jazz
- Rock
- Classic
- Pop
- News
- Treble - tone setting may be adjusted
- Bass - tone setting may be adjusted

Note:

The EQ button is on the remote control only. The unit does not has a EQ button.



EQ Setup
Flat

GB

Treble control

1. Press the EQ button to cycle through the modes until "Treble" appears on the display. The current treble setting will be shown on the display.
2. To adjust the treble setting press and release the Tuning Up or Down buttons until the desired level is displayed.

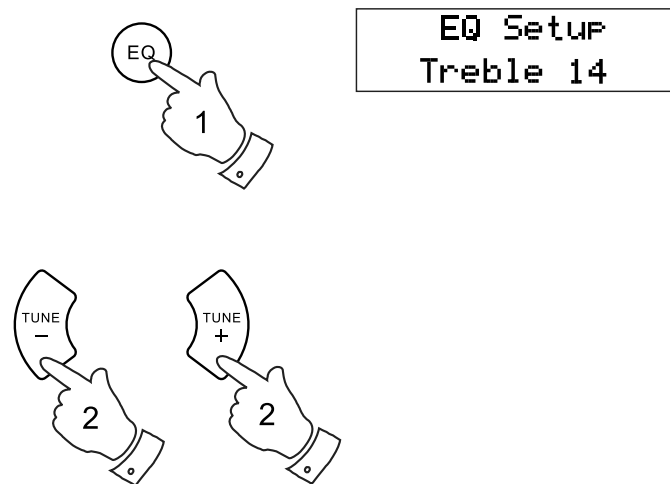

Bass control

1. Press the EQ button to cycle through the modes until "Bass" appears on the display. The current bass setting will be shown on the display.
2. To adjust the bass setting press and release the Tuning Up or Down buttons until the desired level is displayed.
3. Press the Select button to revert to the play mode display.

Note:

To quickly cancel the effect of the treble or bass settings press the EQ button until "Flat" appears on the display. The treble and bass settings will be remembered for the next time that you wish to adjust them.

Mute function

Press the Mute button on the remote control of your radio, it will mute the output from the loudspeaker.

1. Press the Mute button to mute the sound output. The display will show "Volume Muted".
2. Press the Mute button again or one of the Volume Up or Down buttons to un-mute the sound output.



Volume
Muted

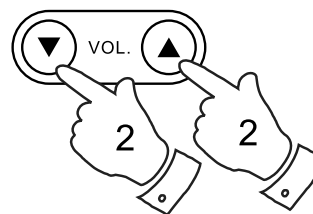

Display backlight dimmer

1. In order to adapt the intensity of the display to suit the ambient room lighting, press the Light button on the remote control or on your clock radio to select the dimmer brightness from level zero to level seven settings.

GB

Factory reset

If your clock radio fails to operate correctly or some digits on the display are missing or incomplete, carry out the following procedures.

1. Press and release the On / StandBy button to switch on your clock radio.
2. Press and release the Advanced button. When the DDR-31 Plus is tuned to a DAB radio station, the display will show "Manual tune."

Note:

Press and release the Advanced button. When the DDR-31 Plus is tuned to an FM station, the display will show "FM scan zone".

3. Press the Tuning Up or Down buttons until the display shows "System".
4. Press and release the Select button to enter the adjustment mode.
5. Press the Tuning Up or Down buttons until the display shows "Factory reset".
6. Press and release the Select button to enter the Factory reset menu.
7. Press the Tuning Up or Down buttons to switch the <No> or <Yes>.
8. Press the Tuning Up or Down buttons to select YES, then press and release the Select button to start the Reset, the display will appear "Restarting...".
9. A full reset will be performed, the station list and presets will be erased. The display will show "Welcome to Digital Radio" for a few seconds and then the flash clock digits and the display will show "Time is not set". When the factory reset is complete, you can set new settings. In case of malfunction due to electrostatic discharge, reset the product (reconnection of power source may be required) to resume normal operation.

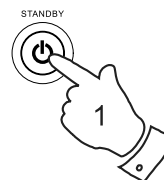

DAB
<Manual tune >

FM
<FM scan zone >



FM
<System >

System
<Factory Reset >

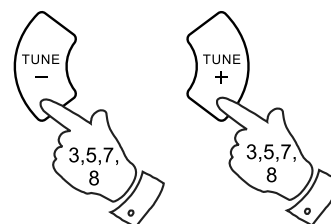

Factory Reset?
No <Yes >



Restarting...

Software version

The software display cannot be altered and is just for your reference. Ensure your radio is switched on and in DAB or FM mode.

1. Press and release the On / StandBy button to switch on your clock radio.

2. Press and release the Advanced button. When the DDR-31 Plus is tuned to a DAB radio station, the display will show "Manual tune."

Note:

Press and release the Advanced button. When the DDR-31 Plus is tuned to an FM station, the display will show "FM scan zone".

3. Press the Tuning Up or Down buttons until the display shows "System".

4. Press and release the Select button to enter the adjustment mode.

5. Press the Tuning Up or Down buttons until the display shows "SW version".

6. Press and release the Select button to display the software version of your clock radio.

7. Press and release the Info button to return to the normal radio mode.

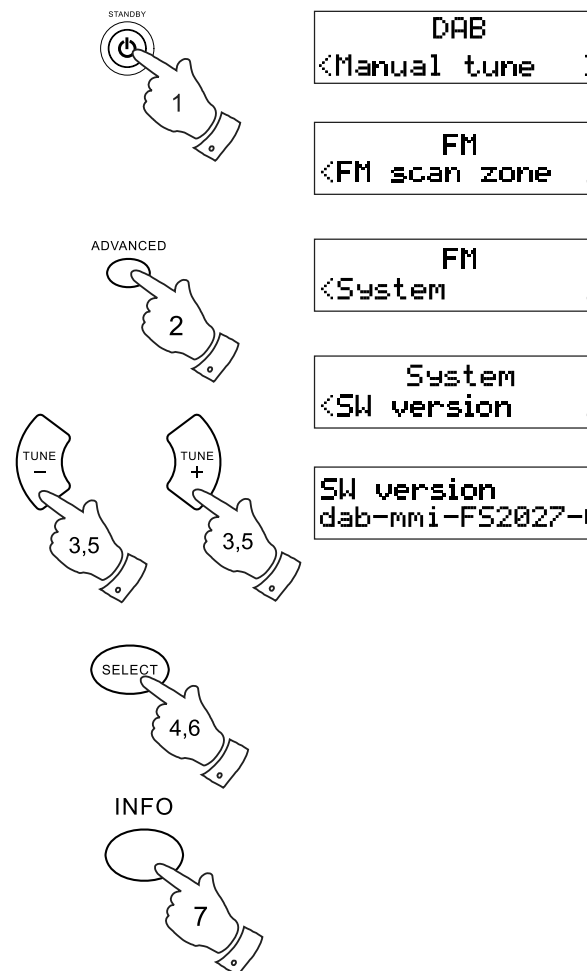

GB

USB socket for software upgrade

Software updates for your clock radio may be available in the future. As software updates become available software and information on how to update your radio can be found at www.sangean.com.tw/index_tw.asp, www.sangean.nl/English, or www.sangean.com.au.

For more information, please contact our Head Office by sending an email to info@sangean.com.

Headphone socket

A 3.5mm stereo Headphone Socket located on the rear of your clock radio is provided for use with either headphones or an earpiece. Inserting a plug automatically mutes the internal loudspeaker.

IMPORTANT:

Excessive sound pressure from earphones and headphones can cause hearing loss.

Auxiliary Input socket

A 3.5mm stereo Auxiliary Input socket is provided on the rear of your radio to permit an audio signal to be fed into the unit from an external audio device such as MP3 or CD player.

1. Connect a stereo or mono audio source (for example, MP3 or CD player) to the Auxiliary Input socket.
2. Press the Mode button until "AUX IN" is selected on the display.
3. Adjust the Volume Up or Down buttons on your MP3 or CD player to ensure an adequate signal and then adjust the volume on the radio for comfortable listening.

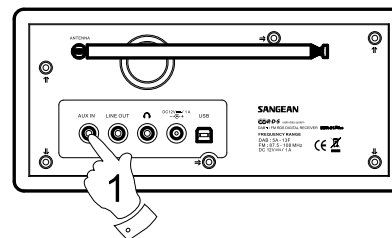
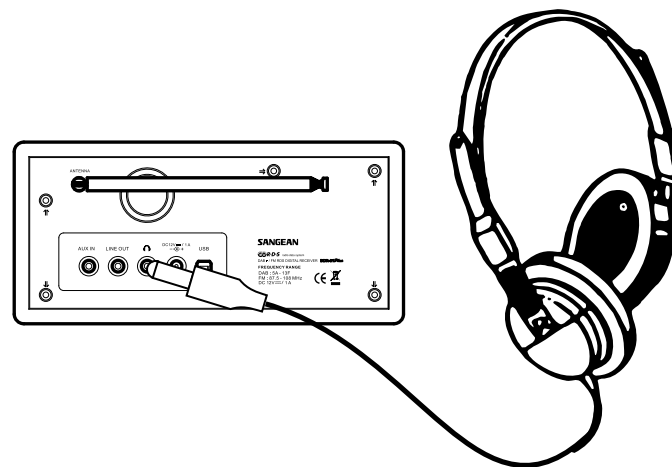

Line Out socket

1. A 3.5mm stereo Line Out socket is provided on the rear of your sound system to permit the audio signal to be fed to an external amplifier or other audio device.

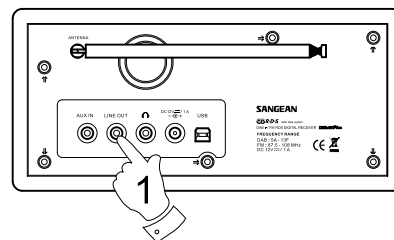

Cautions

Do not allow this radio to be exposed to water, steam or sand. Do not leave your radio where excessive heat could cause damage such as in a parked car where the heat from the sun can build up even though the outside temperature may not seem too high.

- Your radio should not be exposed to dripping or splashing and that no objects filled with liquids, such as vases, shall be placed on the radio.
- It is recommended to operate the product such that there is a minimum distance (10cm recommended) to adjacent objects in order to ensure good ventilation.
- The ventilation of the product should not be restricted by covering it or its ventilation openings with items such as newspapers, tablecloths, curtains etc.
- No naked flame sources such as lighted candles should be placed on the product.
- It is recommended to avoid using or storing the product at extremes of temperature. Avoid leaving the unit in cars, on window sills, in direct sunlight etc.

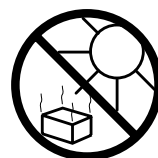

GB

Specifications

Power Requirements

Mains:

AC 100 ~ 240 volts, 50 Hz-60 Hz DC 12V 1A only (switching adaptor)

Frequency Coverage

FM 87.5 - 108MHz

DAB 174.928 - 239.200MHz

Circuit Features

Loudspeaker: 3", 8 ohm

Output Power: 7 Watt

Headphone socket: 3.5mm dia

Auxiliary Input socket: 3.5mm dia

Line out socket: 3.5mm dia

Aerial System:

FM Telescopic aerial

DAB+ Telescopic aerial

The Company reserves the right to amend the specification without notice.

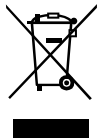

If at any time in the future you should need to dispose of this product please note that: Waste electrical products should not be disposed of with household waste. Please recycle where facilities exist. Check with your Local Authority or retailer for recycling advice. (Waste Electrical and Electronic Equipment Directive)