

DPR-25+

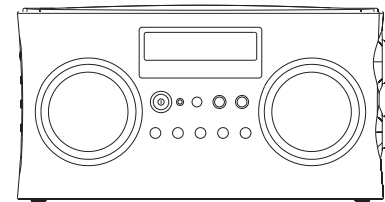

GB

Revision 1

Contents

<i>Controls</i>	2-4	<i>Auxiliary in socket</i>	20
<i>Battery operation using alkaline batteries</i>	5	<i>Line out socket</i>	20
<i>Battery operation using rechargeable batteries</i>	5-6	<i>Headphone socket</i>	20
<i>Using the AC adaptor</i>	6	<i>News/Music sound switch</i>	21
<i>Operation modes</i>	7	<i>Display backlight</i>	21
<i>Operating your radio – DAB</i>	8	<i>A few words about batteries</i>	22
<i>Selecting a station – DAB</i>	9	<i>Rechargeable batteries</i>	22-23
<i>Secondary services – DAB</i>	9	<i>Specifications</i>	24
<i>Presetting stations</i>	10	<i>Circuit features</i>	24
<i>Recalling a preset station</i>	10		
<i>Finding new stations – DAB</i>	11		
<i>Manual tuning - DAB</i>	11		
<i>Operating your radio – Search tuning FM</i>	12		
<i>Manual tuning – FM</i>	13		
<i>Display modes – DAB</i>	14		
<i>Display modes – FM</i>	15		
<i>Dynamic Range Control (DRC) settings – DAB</i>	16		
<i>Stereo/Mono setting – FM</i>	17		
<i>Scan sensitivity setting – FM</i>	18		
<i>System reset</i>	19		

Controls(Front)

GB

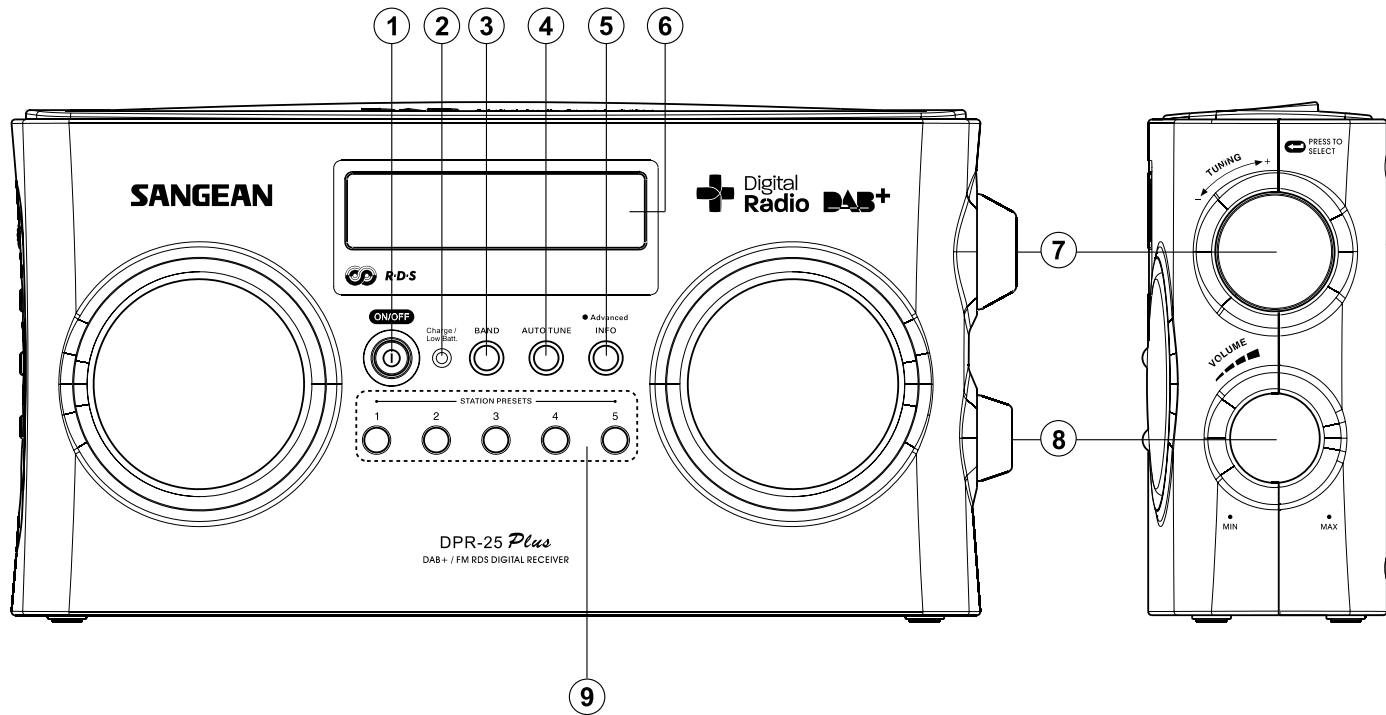

1. Power On/Off
2. Charge/Low battery indicator
3. Band button
4. Auto Tune button
5. Advanced information button

6. LCD display
7. Tuning Control
8. Volume Control
9. Station presets

Controls(Back)

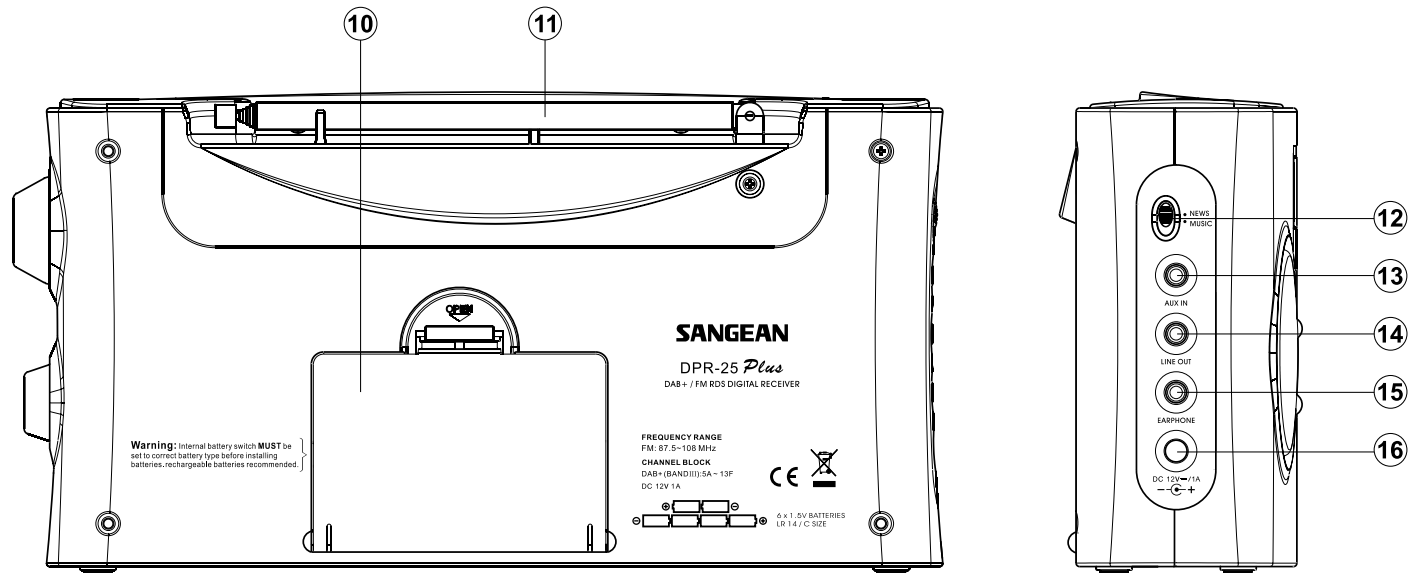

- 10. Battery compartment
- 11. Telescopic aerial
- 12. Music/News tone control
- 13. Aux In socket

- 14. Line Out socket
- 15. Headphone socket
- 16. DC input socket

Controls(Back)

GB

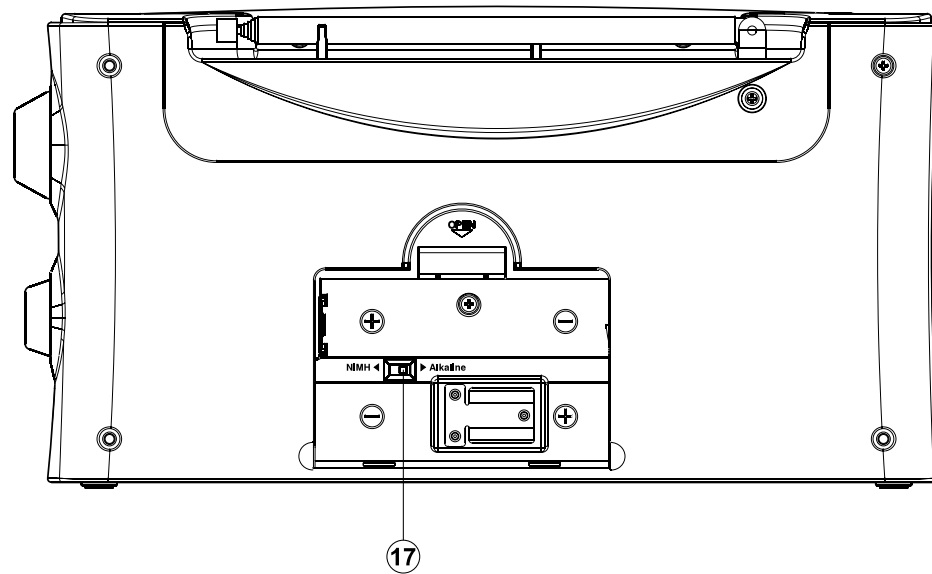

17. Rechargeable/Alkaline battery switch

Battery operation using alkaline batteries

1. Remove the battery cover on the rear of the unit by sliding the catch.
2. Insert six C size (UM2, LR 14) alkaline batteries into the spaces in the compartment. Ensure all batteries are inserted with the correct polarity as shown inside the battery compartment.
3. Slide the battery switch to the Alkaline position and then replace the battery cover.

- **Important: when using alkaline batteries, the battery switch must be placed in the alkaline position. Failure to do so could result in serious damage to the batteries or radio.**
- Reduced power, distortion and a “stuttering” sound are all the signs that the batteries may need replacing.
- If the radio is not to be used for any extended period of time, it is recommended that the batteries are removed from the radio.
- *We would recommend for economy that the radio is used via the AC adaptor whenever possible with battery operation for occasional or standby use only. If extended listening using batteries is anticipated, then the use of rechargeable batteries is recommended.*

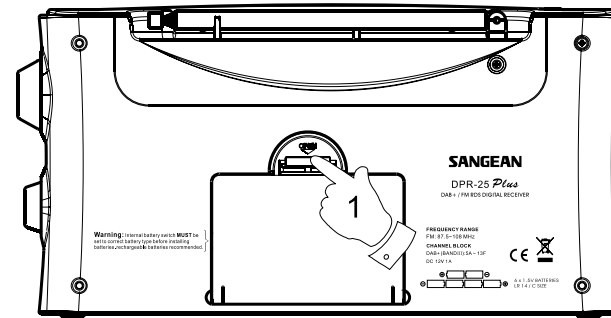

Battery operation using rechargeable batteries

1. Remove the battery cover on the rear of the unit by pushing the catch.
2. Insert six Rechargeable LR 14 (C size, UM 2) batteries into the spaces in the compartment. Take care to ensure all batteries are inserted with the correct polarity as shown inside the battery compartment. The radio is designed to be used with Nickel Metal Hydride (NiMH) rechargeable batteries.
3. Slide the battery switch to the NiMH position and then replace the battery cover.

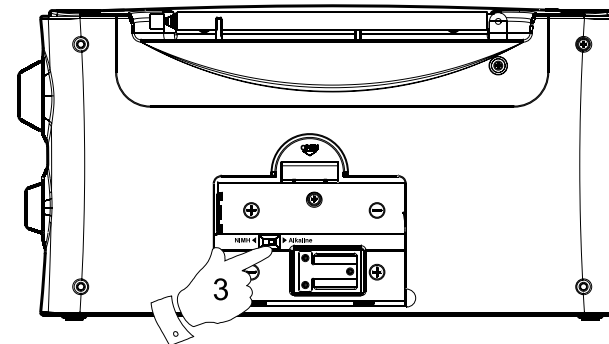

4. Plug the supplied power adaptor into the radio and connect to the mains.
 5. The Charge LED will flash green indicating battery are charging. Batteries will be fully charged in around 8 hours. The Charge LED will show a steady green when the batteries are fully charged.
- **Important: When using rechargeable batteries, the battery switch must be placed in the NiMH position. Batteries will only be charged when the radio is switched off and connected to the AC adaptor.**
 - Reduced power, distortion or your radio switching off by itself are all signs that the batteries may need charging.
 - If the radio is not to be used for any extended period of time, it is recommended that the batteries are removed from the radio.
- Important:** The batteries should not be exposed to excessive heat such as sunshine, fire or the like. After use, disposable batteries should if possible be taken to a suitable recycling center. The batteries shouldn't be disposed by incineration.

Using the AC adaptor

Your radio is supplied with a Mains adaptor.

1. Place your radio on a flat surface.
 2. Insert the adaptor plug into the DC socket located on the left hand end of your radio.
 3. Plug the adaptor into the mains socket outlet. Whenever the adaptor is used, the batteries are automatically disconnected.
The AC adaptor should be disconnected from the mains supply and the radio when not in use.
- **Important:** The mains adaptor is used as the means of connecting the radio to the mains supply. The mains socket used to the radio must remain accessible during normal use. In order to disconnect the radio from the mains completely, the mains adaptor should be removed from the mains socket outlet completely.

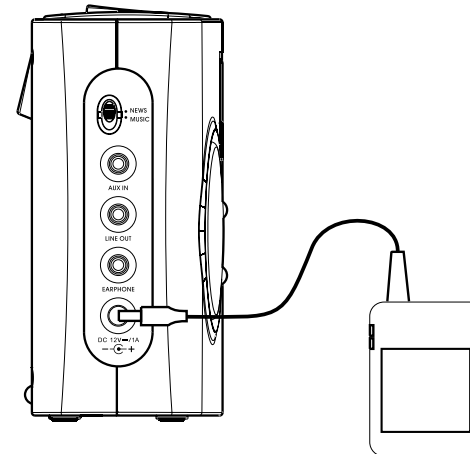

Operation modes

Your radio has 3 operation modes DAB, FM and Auxiliary input.

1. Press the Band button to change the operation mode between DAB, FM.

Note:

Display will show AUX IN only when the AUX IN socket is plugged in by a 3.5 mm cable from MP3 players, mini disc players and similar devices.

2. DAB mode is used for listening to Digital Radio broadcasts.

3. FM mode is used for listening to FM radio broadcasts.

4. The DPR 25 Plus has a Auxiliary input socket which can be used an amplifier and loudspeaker system for external MP3 players, mini disc players and similar devices.

BAND



BBC 7
Just a Minute...

FM 89.30 MHz

Play track
◆ DAB000.MP2 ◆

AUX IN

Operating your radio – DAB

1. Carefully extend the telescopic aerial.
2. Press the On/Off button to switch on your radio. The display will show "Welcome to Digital radio".
3. If this is the first time the radio is used, a quick scan of Band III DAB channels will be carried out, known as Auto-Tune. The display will show "Welcome to DAB".
4. During Auto-tune, the lower line of the display show a bar graph indicating progress of auto-tune. If the radio has been used before, then the last used station will be selected instead of the Auto-tune progress.
5. When the Autotune is completed, the first station (in numeric-alpha order 0...9.. A...Z) will be selected.
6. If the station list is still empty after the Autotune, your radio will display "Station List".
7. If no signals are found, it may be necessary to relocate your radio to a position giving better reception.

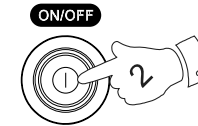

GB

Welcome to
Digital Radio

Welcome to DAB

Welcome to DAB 4
■■■■■■■■

1Xtra
BBC National

DAB
◆ station list ◆

Selecting a station – DAB

1. The top line of the display shows the name of the station currently selected.
2. Rotate the Tuning control to scroll through the list of available stations. Stop rotating the tuning control when you find the station you wish to hear.
3. Press and release the Tuning control to select the station. The display may show “Now tuning” while your radio finds the new station.
4. Adjust the Volume control to the required setting.

Note:

If after selecting a station the display shows “Service not available” may be necessary to relocate your radio to a position giving better reception.



Classic

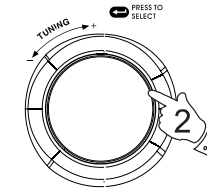
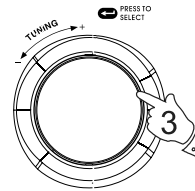

Now tuning...

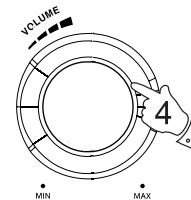

IXtra
Now playing.

Secondary services – DAB

1. Certain radio stations have one or more secondary services associated with them. If a radio station has a secondary service associated with it, the display will show “>>” next to the station name on the station list. The secondary service will then appear immediately after primary service as you rotate the tuning control clockwise.
2. Press and release the Tuning control to select the station.
3. When the secondary service shuts down, your radio will automatically switch back to the main radio station (or primary service) if it is available.

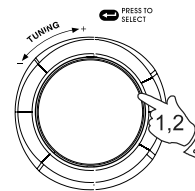

BBC Radio 5



◆ BBC 5 Live ◆



BBC Radio 5



◆ << BBC Sport ◆

Presetting stations

There are 5 memory presets on each radio band DAB and FM.
1. Press the On/Off button to switch on the radio.

2. Tune to the required station as previously described.

3. Press and hold down the required Preset button until the display show e.g. "Preset 1 stored". The station will be saved under the chosen preset button. Repeat this procedure for the remaining presets.

4. Stations stored in preset memories may be overwritten by following above procedures.

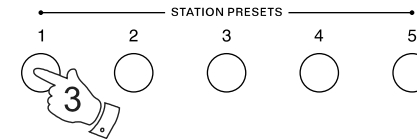
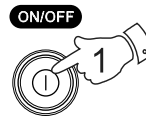

GB

BBC R2
Preset 1 stored

Recalling a preset station

1. Press the On/Off button to switch on your radio.

2. Select required waveband by pressing the Band button.

3. Momentarily press the required Preset button, your radio will tune to the station stored in preset memory.

Note:

If you have not previously stored a preset station and preset buttons are pressed "Preset empty" will be displayed.

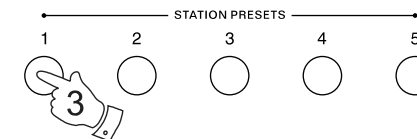
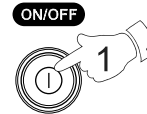

1Xtra
BBC National

Finding new stations – DAB

As time passes, new station may become available. To find new stations proceed as follows:

1. Press and release the Auto Tune button, the display will show "Scanning". Your radio will perform a scan of the DAB frequencies. As new stations are found, the station counter on the right-hand side of the display will increase and stations will be added to the list.



Manual tuning - DAB

Manual Tuning allows you to tune directly to the various DAB channels.

1. Press and hold down the advanced Info button, "Manual tune" will appear on the display. Press and release the Tuning control.
2. Rotate the Tuning control to select the required DAB channel.
3. Press and release the Tuning control to select the channel. Any new stations that are found are automatically added to the stored list of station.
4. Press and release the Tuning control to return to normal tuning mode.

● Advanced
INFO

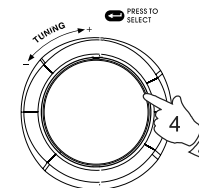
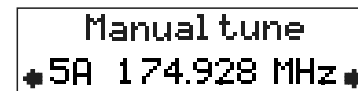
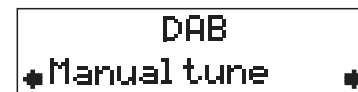
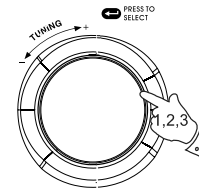

Operating your radio – Search tuning FM

1. Fully extend the telescopic aerial for FM reception.
2. Press and On/Off button to switch on your radio. The display will show “Welcome to Digital Radio”.
3. Press the Band button to select the FM band.
4. Press and immediately release the Auto tune button, your radio will scan in an upwards direction (low frequency to high frequency) and stop automatically when it finds a station of sufficient strength.
5. After a few seconds, the display will update and may show the station name (FM RDS).
6. To find other stations, press and release the Auto tune button as before.
7. To scan the FM band in a downwards direction (high frequency to low frequency), press and hold down the Auto tune button for 0.5 seconds and then release.
8. When the waveband end is reached, your radio will recommence tuning from the opposite waveband end.
9. Adjust the Volume control to the required setting.
10. To switch off your radio, press On/Off button.

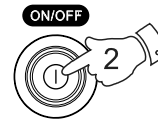

Welcome to
Digital Radio

GB

BAND



89.30 MHz FM
Just a Minute...

AUTO TUNE



Searchin9... >

AUTO TUNE



Searchin9... <

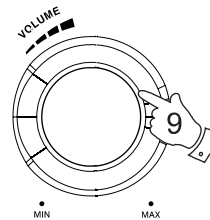

Manual tuning – FM

1. Press the On/Off button to switch on your radio.
2. Press the Band button to select the FM band.
3. Rotate the Tuning control to tune to a station. The frequency will change in steps of 50 kHz on FM.
4. When the waveband end is reached, the radio will recommence tuning from the opposite waveband end.
5. Set the Volume control to the desired settings.
6. To switch off your radio, press the On/Off button.

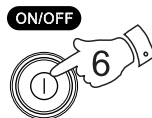
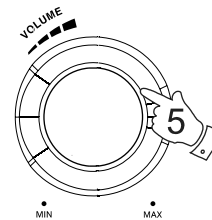
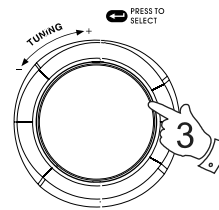
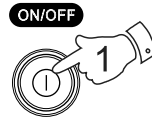

89.30 MHz FM
Just a Minute...

Display modes – DAB

Your radio has seven display modes:

1. Press the Advanced info button to cycle through the various modes

- | | |
|----------------------------|--|
| a. Scrolling text | Displays scrolling text messages such as artist/track name, phone in number etc. |
| b. Program type | Displays type of station being listened to e.g. Pop, Classic, News etc. |
| c. Multiplex name | Displays name of multiplex to which current station belongs. |
| d. Time and date | Displays current time and date. |
| e. Channel and frequency | Displays current channel and frequency. |
| f. Audio type and bit rate | Displays audio type and bit rate. |
| g. Signal strength | Displays signal strength for station being listened to. |

● Advanced
INFO



a
BBC 7
Just a Minute...

GB

b
BBC 7
Culture

c
BBC 7
BBC National

d
BBC 7
19:17 08-02-2007

e
BBC 7
11C 220.35 MHz

f
BBC 7
Stereo J 128kbps

g
BBC 7
■■■■■□■■■■

Display modes – FM

In FM mode the bottom line of the display can be set to any of the following modes:

1. Press the Advanced info button to cycle through the various modes.

- | | |
|-------------------|--|
| a. Scrolling text | Displays scrolling text messages such as artist/track name, phone in number etc. |
| b. Program type | Displays type of station being listened to e.g. Pop, Classic, News etc. |
| c. Time and date | Displays current time and date. |
| d. Frequency | Displays frequency of the station being listened to. |
| e. Auto/Mono | Displays Stereo or Mono broadcasting of listening station. |

Note:

When tuned to the FM band, information display is only available when the radio is able to receive RDS information from the broadcaster.

● Advanced
INFO



- | | | | |
|---|--------|----|------------------|
| a | BBC R2 | FM | The latest news |
| b | BBC R2 | FM | Pop Music |
| c | BBC R2 | FM | 12:02 16-06-2008 |
| d | BBC R2 | FM | 89.30MHz |
| e | BBC R2 | FM | Mono |

Dynamic Range Control (DRC) settings – DAB

DRC can make quieter sounds easier to hear when your radio is used in a noisy environment.

1. Press the On/Off button to switch on your radio.
2. Press and hold in the Advanced in button until display shows "Manual tune".
3. Rotate the Tuning control until the display show "DRC".
4. Press and release the Tuning control to enter adjustment mode.
5. Rotate the Tuning control to select required DRC setting (default is 0)
DRC 0 DRC is switched off, Broadcast DRC will be ignored.
DRC 1/2 DRC level is set to 1/2 that sent by broadcaster.
DRC 1 DRC is set as sent by broadcaster.
6. Press and release the Tuning control to confirm the setting.
The display will return to radio mode.

Note:

Not all DAB broadcasts are able to use the DRC function.
If the broadcast does not support DRC, then the DRC setting is the radio will have no effect.

● Advanced
INFO

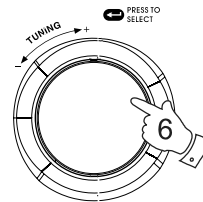
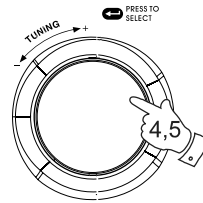
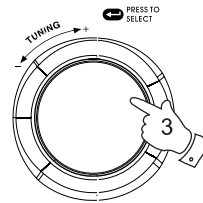
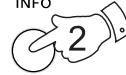

GB

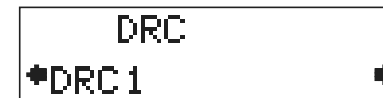
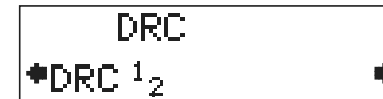
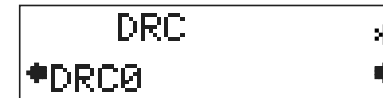
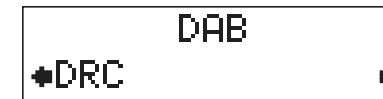

Stereo/Mono setting – FM

Your radio will play stereo broadcasts in stereo so long as the received signal is of adequate strength. However, as a stereo signal becomes weaker, the audio signal will become poorer. It may be preferable to force the radio to play the station in mono in order to reduce the level of audio noise.

1. Press the On/Off button to switch on your radio.
2. Tune to the required FM radio station as previously described.
3. Press in and hold down the Select button until the display shows "Switch to Mono/Auto".

Note: your radio default is Auto.

ON/OFF

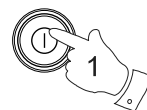

89.30 MHz FM
Switch to Auto

89.30 MHz FM
Switch to Mono

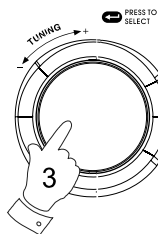

Scan sensitivity setting – FM

Your radio will normally scan for FM broadcasts which are strong enough to give good reception. However, you may wish the Auto-scan function to be able to find weaker signals, possibly from more distant radio transmitters. Your radio includes a local/distant option for the Auto-scan function.

1. Press the On/Off button to switch on your radio.
2. If needed, press the Band button to select the FM band.
3. Press and hold down the Advanced info button until “FM Scan Zone” appears on the display.
4. Press and release the Tuning control to select FM Scan Zone then rotate the Tuning control to choose between Local and Distant options, press and release the Tuning control to choose. The Distant option will allow the radio to find weaker signals when scanning.
5. The radio will then revert to the normal information display. The Local or Distant setting is stored in the radio and remains in force until changed or until a System Reset.

Note:

The initial setting (out of box or after a System Reset) causes the radio to ignore weak (distant) signals.

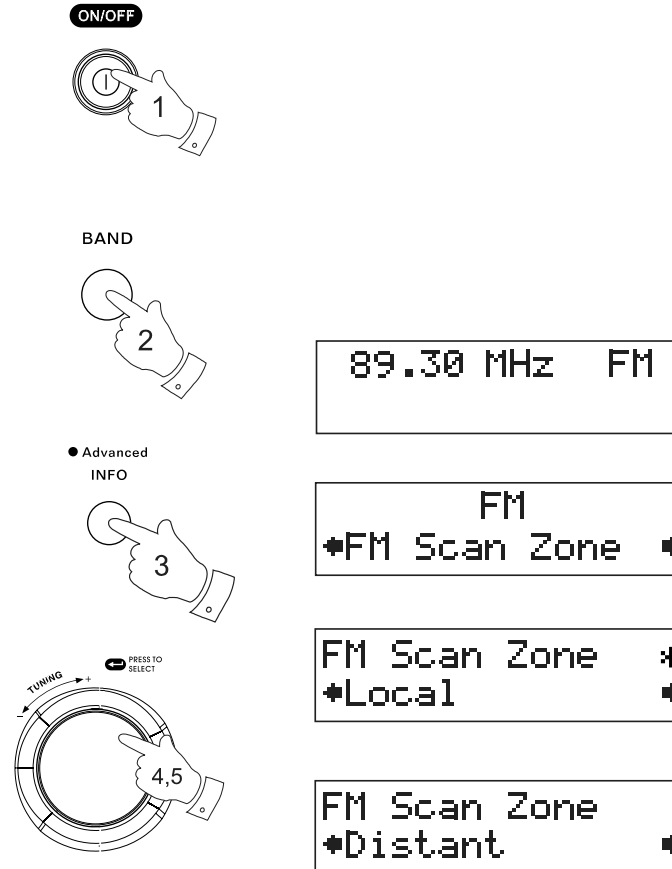

GB

System reset

If your radio fails to operate correctly, or some digits on the display are missing or incomplete, carry out the following procedures.

1. Switch on your radio.
2. Press and hold in the Advanced info button until "Manual tune" appears on the display.
3. Rotate the Tuning control until the display shows "Factory reset".
4. Press in and release the Tuning control, the display will show "Press SELECT to confirm reset...".
5. Press the Tuning control to confirm. A full reset will be performed and all presets and station lists will be erased. A quick scan of DAB band frequencies will be carried out.

In case of malfunction due to electrostatic discharge, reset the product (reconnection of power source may be required) to resume normal operation.

● Advanced
INFO

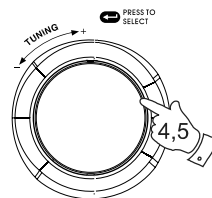
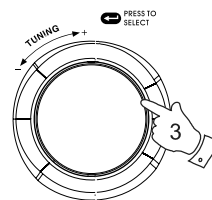

DAB
◆ Manual tune ◆

DAB
◆ Factory reset ◆

Press SELECT to
confirm reset...

Restarting...

Welcome to DAB 4
■■■■■

Auxiliary in socket

1. Connect stereo or mono audio source (i.e. CD Walkman, iPod, MP3 players) to the Auxiliary in socket.
2. "Aux In" will show on the display.
3. Adjust the Volume control for comfortable listening.

AUX IN

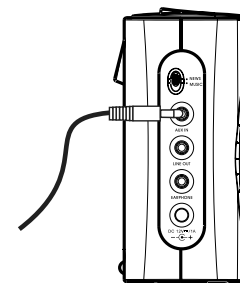

Line out socket

A 3.5 mm Line out socket located on the left hand end of your radio is provided for connecting the audio signal to an external amplifier. Inserting a line out audio cable will not mute the internal loudspeaker. Set the volume control to the minimum if desired.

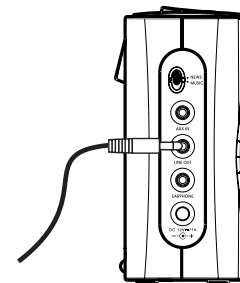

Headphone socket

A 3.5 mm Headphone socket located on the left hand end of your radio is provided for use with either headphones or an earpiece. Inserting a plug automatically mutes the internal loudspeaker.

Important:

Excessive sound pressure from earphones and headphones can cause hearing loss.

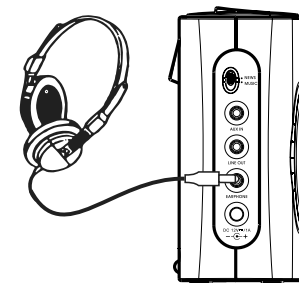

News/Music sound switch

For all normal listening, it is recommended to use the sound/music switch in the music position.

The alternative news position is intended to make speech clearer when there is significant background noise or music in the program content.

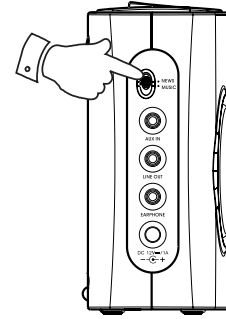

Display backlight

1. When your radio is powered by the AC adaptor, the display backlight will always be switched on.
2. When using on batteries, the display backlight will be switched on for approx. 12 seconds when any button is pressed.

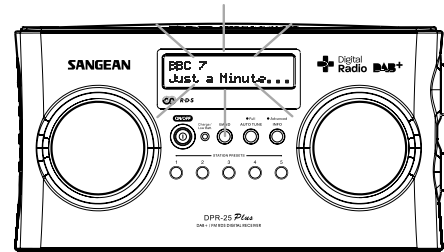

A few words about batteries

Your radio has been designed to use a choice of power sources. You may plug it into the mains using the supplied adaptor. or for listening away from the mains, you may use either alkaline or rechargeable batteries. We do not recommend the use of carbon-zinc or zinc-chloride batteries.

It is very important that you read the advice and warnings given below.

- 1) whichever type of batteries you choose to use. It is very important that the battery selection switch under the cover is set to the correct type.
 - a. If no batteries are fitted, then set the switch to the Alkaline position. This position minimizes the power consumption when the radio is powered from the mains.
 - b. If Alkaline batteries are fitted, then set the switch to the Alkaline position.
 - c. If Rechargeable batteries are fitted, then set the switch to the NiMH position. Your radio is designed to use Nickel-Metal-Hydride rechargeable batteries. No other type of rechargeable battery should be used in this radio.
- 2) NEVER mix old and new Alkaline batteries. The old batteries may suffer damage and leak which will damage your radio and whatever the radio is standing on.
- 3) NEVER mix old and new Rechargeable batteries. This may result in unreliable charging and shorten battery life. Never mix Rechargeable batteries of different types or capacities even if they are new.
- 4) NEVER mix Alkaline and Rechargeable batteries. The recharging of Alkaline batteries can be very dangerous.

Rechargeable batteries

Your radio use a range of methods to ensure correct and safe charging of Rechargeable Nickel-Metal-Hydride batteries. These work to protect your batteries from excessive charge and discharge.

These protection can only work properly if the advice above is followed. In particular, the radio will not be able to correctly charge batteries if they are a mixture of different brands, or different ages, or different capacities.

We recommend that all the rechargeable batteries used in your radio are bought together as a set. They should always be charged together and discharged together and not "borrowed" from time to time for other applications. This will ensure that they give their optimum performance in your radio.

We recommend that the rechargeable batteries that you use should be from a quality brand, and should be of at least 4000mAh capacity. Batteries of this capacity should be able to power your radio for between 10 and 20 hours depending upon the volume of the radio, whether DAB or FM mode is used (DAB mode uses slightly less power than FM), and also depending on the condition of the batteries.

Before you first install a new set of rechargeable batteries into your radio, you should first make sure that the battery type switch beneath the battery cover is in the NiMH (rechargeable) position. Install the batteries arranging them as shown on the back of the radio. Plug the mains adaptor into a mains socket and then into the radio. While the batteries are charging, the battery indicator should show a flashing green light. When the batteries are fully charged, the indicator will stop flashing and will show a steady green light. The time taken to charge the batteries will depend on how much charging they require. New batteries may be partly charged when first fitted, but it is normal for a set of batteries to take several hours to charge fully (this can be between 6 and 9 hours depending on the battery capacity and their initial state of charge).

GB

If you use the radio powered from batteries, the battery light will be off until the batteries are exhausted. The battery light will then show red for a while before the radio switches itself off. It does this in order that the batteries are not excessively discharged. This would otherwise damage the batteries and shorten their life.

If you use the radio powered from the mains with rechargeable batteries fitted, the charging process is suspended until you switch off the radio. When you switch off the radio using its On/Off button, charging will then resume. If the batteries have already been charged then they will only charge for a few more minutes before the battery charge indicator stops flashing.

If you only listen to your radio for short periods, you do not need to connect your radio to the mains to charge the batteries every time that you use it. However, if the radio is not to be used for a few weeks, we recommend that the batteries are fully charged before the radio is put to one side (charge light show steady green).

If you intend not to use your radio for some months, then we recommend that the batteries are removed and put away, keeping them in a cool place out of reach of children, away from moisture and such that no metal object can contact the battery terminals.

With care, rechargeable batteries can last a long time and can operate for many hundreds of charge and discharge cycles. When your rechargeable batteries can no longer power your radio adequately, please dispose of them thoughtfully.

To avoid danger and risk of injury, please follow these guide lines

Improper use of batteries may result in leakage of fluid, overheating or explosion. Battery fluid is corrosive and may also be toxic. Battery fluid can cause skin burns, can damage the eyes, and can be harmful if swallowed.

1. Keep batteries out of the reach of children.
2. Do not heat, open, puncture, mutilate or dispose of batteries by burning.
3. Do not mix different battery types or old and new batteries. Always replace all the batteries at the same time.
4. Do not carry or store batteries such that metal objects may contact the end caps.
5. Remove batteries from the radio if they are worn out or if you are storing it for a long time.
6. Remove old or worn out batteries promptly, and recycle or dispose of them according to the regulations applicable to your location.
7. If a battery does leak, remove all batteries from the product, taking care to avoid directly touching the leaked fluid. If the fluid contacts skin or clothes, wash with water immediately. Before inserting new batteries, thoroughly clean the battery compartment with a damp paper towel, or follow the battery manufacturer's advice for clean up.

Specifications

Power Requirements

Mains AC 100-240 Volts, 50-60 Hz ~ only (adaptor)
Batteries 6 x LR14 (C size, UM2)

Battery life

Approx. 20 hours listening for 4 hours a day at normal volume using alkaline cells.

Frequency Coverage

DAB 174.928 – 239.200 MHz
FM 87.50 – 108 MHz

Circuit features

Loudspeaker 2 x 89 mm 8 ohms

Output Power 2 x 1 Watt

Headphone socket 3.5 mm dia

Aux In socket 3.5 mm dia

Line out 3.5 mm dia

Aerial System

DAB and FM Telescopic aerial

GB

The company reserves the right to amend the specification with notice

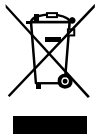

If at any time in the future you should need to dispose of this product please note that: Waste electrical products should not be disposed of with household waste. Please recycle where facilities exist. Check with your Local Authority or retailer for recycling advice. (Waste Electrical and Electronic Equipment Directive)