

DPR-45

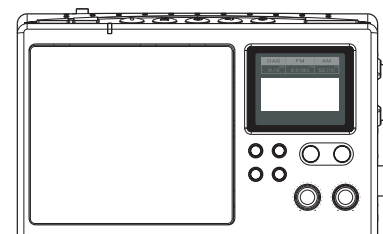

GB

Version 1

Table of Contents

<i>Important safety instructions</i>	2-3
<i>Controls and connections</i>	4-6
<i>Display icons</i>	7
<i>Using the Digital Receiver for the First time</i>	8
<i>Operating Your Digital Receiver – DAB</i>	9-10
<i>Display Modes – DAB</i>	11
<i>Finding New Stations – DAB</i>	12
<i>Manual Tuning – DAB</i>	12
<i>Dynamic Range Control (DRC) settings – DAB</i>	13
<i>Operating your digital receiver – Search tuning FM</i>	14
<i>Manual tuning – FM</i>	15
<i>Display Modes – FM</i>	15
<i>FM Stereo / mono</i>	16
<i>Operating your digital receiver- Search Tuning</i>	17
<i>Manual tuning- AM</i>	18
<i>Display modes-AM</i>	18
<i>Presetting Stations in DAB / FM / AM modes</i>	20
<i>Recalling a Preset in DAB / FM / AM modes</i>	21
<i>Clock and Alarms</i>	22-27
<i>Display and Audio</i>	28
<i>Information</i>	29
<i>Key lock function</i>	30
<i>Software upgrade</i>	31

Important Safety Instructions

1. Read and understand all safety and operating instructions before the radio is operated.
2. Retain instruction: The safety and operating instructions should be retained for further reference.
3. Heed warnings. All warnings on the appliance and operating instructions should be followed.
4. Follow all operations and use instructions.
5. Water and moisture: The appliance should not be used near water. Does not use near a bathtub, washbowl, laundry tub, kitchen sink, wet basement, swimming pool, etc.
6. Unplug the radio from the AC power outlet before cleaning. Use only a damp cloth for cleaning the exterior of the radio.
7. Do not place the radio on an unstable cart, stand, bracket or table. The radio may fall, causing serious personal injury and damage to the radio.
8. Ventilation: This radio should be situated so that its location or position does not interfere with its proper ventilation. For example, the radio should not be used on a bed, sofa, rug or other soft surfaces that may block the ventilation openings. It should not be placed in a built-in situation like a cabinet that may reduce air flow through the ventilation openings.
9. Power sources: The radio should be operated only from the type of power source indicated on the marking label. If you are not sure of the type of power supply to your home, consult your radio dealer or power company.
10. Mains adaptor: The mains adaptor should be positioned so it is not walked on, pinched, or items placed on top of it. Pay particular attention to wires at plugs, convenience receptacles, and the point where they exit from the unit. Unplug the mains adaptor by gripping the adaptor, not the wire. Operate the radio using only the current type of power source indicated. If you are not sure of the type of power supply to your home, consult your dealer or local power company.
11. Do not overload wall outlets or extension cords. This can result in a risk of fire or electric shock. Never insert objects of any kind into the radio through opening. The objects may touch dangerous voltage points or short out parts. This could cause a fire or electric shock.
12. If the radio is left unattended or unused for long periods of time, unplug it from the wall outlet. This will prevent damage caused by lightning or power line surges.
13. If the radio is left unattended or unused for long periods of time, remove the batteries. The batteries may leak and damage furniture or your radio.

14. Do not attempt to service the radio yourself. Removing the cover may expose you to dangerous voltage, and will void the warranty.
Refer all servicing to authorized service personnel.
15. Object and Liquid Entry-Never push objects of any kind into this radio through opening as they may touch dangerous voltage points or short-out parts that could result in a fire or electric shock. Never spill liquid of any kind of product.
16. The appliance should be serviced by qualified personnel when:
- A. The mains adaptor or the plug has been damaged.
 - B. Objects have fallen or liquid had been spilled into the radio.
 - C. The radio has been exposed to rain or water.
 - D. The radio does not appear to operate normally or exhibits a marked change in performance.
 - E. The radio has been dropped, or the enclosure damaged.

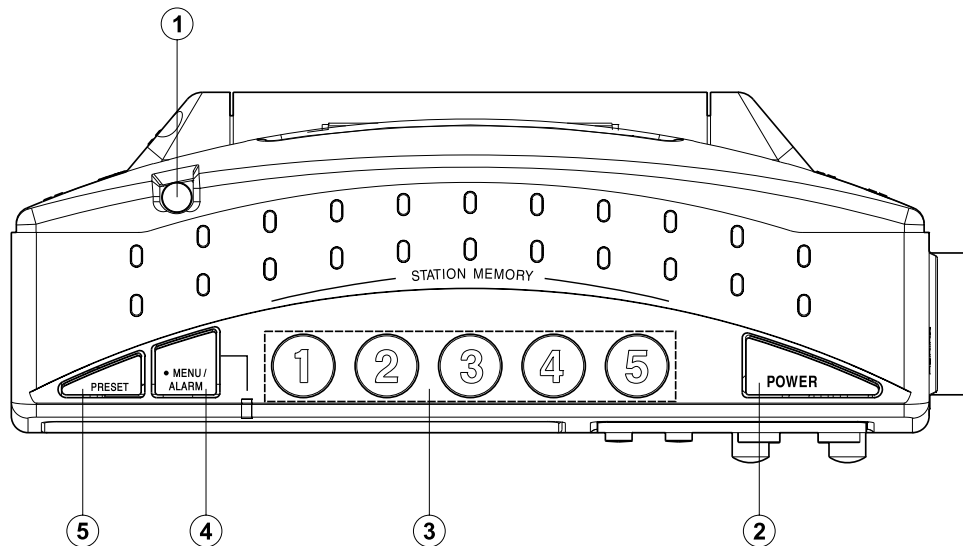

1. Telescopic Aerial
2. Power on / off
3. Favorite station memory button
4. Menu / Alarm button
5. Preset button

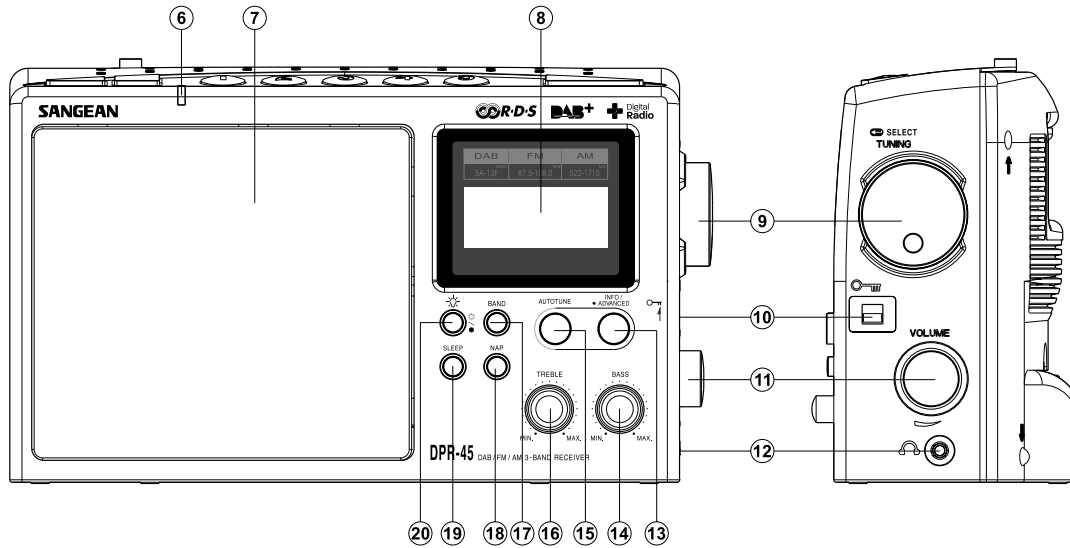

- 6. Alarm On LED indicator
- 7. Loudspeaker
- 8. Display
- 9. Tuning / Select knob
- 10. Lock switch
- 11. Volume control
- 12. Headphone socket
- 13. Info / Advanced setting

- 14. Bass control
- 15. Auto tune button
- 16. Treble control
- 17. Wave band selection
- 18. Timer button
- 19. Sleep timer button
- 20. Brightness control button

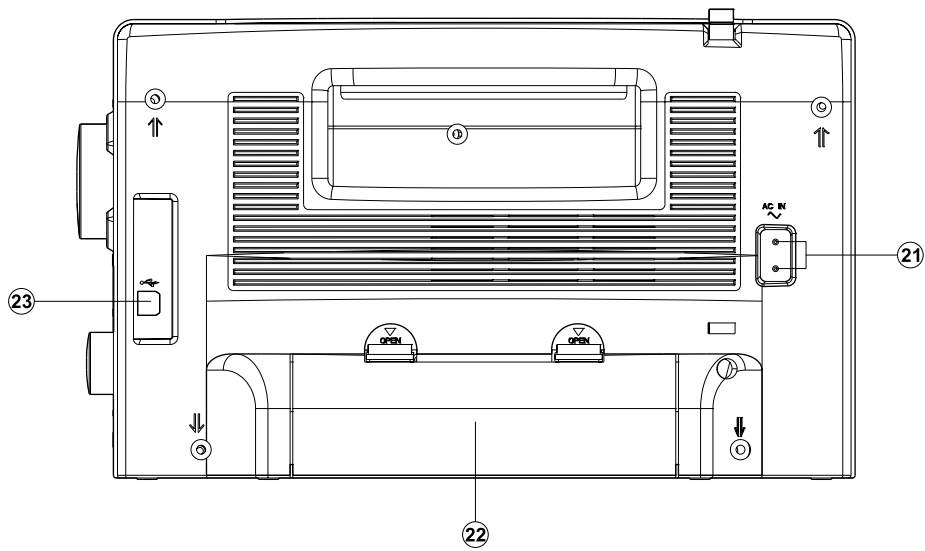

- 21. AC socket
- 22. Battery compartment
- 23. USB socket for software upgrade

Display icons

- A. Battery capacity indicator
- B. Alarm 1 icon
- C. Alarm 2 icon
- D. DAB icon
- E. FM icon
- F. Timer icon
- G. Sleep timer / snooze indicator
- H. Signal strength indicator
- I . Time / Radio display screen

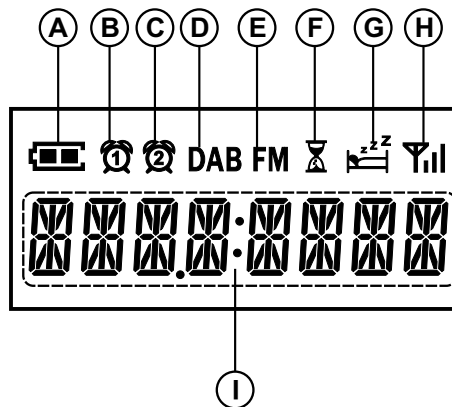

Using the digital receiver for the first time

1. Place your digital receiver on a flat surface.
2. Insert the adaptor plug into the AC in socket located on the back of your digital receiver ensuring that the plug is pushed fully into the socket.
3. Plug the other end of the adaptor into the wall socket.

IMPORTANT:

The mains adaptor is used as the means of connecting the digital receiver to the mains supply. The mains socket used for the digital receiver must remain accessible during normal use. In order to disconnect the digital receiver from the mains completely, the adaptor should be removed from the mains socket outlet completely.

4. When your digital receiver is first switched on the clock display will show SANGEAN briefly first and then NO CLOCK, and the unit will enter standby mode. It will then scan for DAB radio stations and when stations have been found the clock time should be set automatically.
Note that the display will not show any scanning message for this first scan.
5. If no stations have been found then the clock will not set. You may need to relocate your digital receiver to a position giving better reception. You should then carry out an auto-tune to find DAB stations.

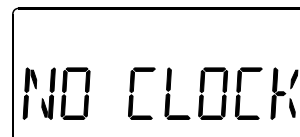
A rectangular digital display showing the word "SANGEAN" in a seven-segment font.A rectangular digital display showing the words "NO CLOCK" in a seven-segment font.

Operating your digital receiver – DAB

1. Press the Standby button to switch on the digital receiver. If the digital receiver has been used before the last used mode will be selected.
2. Press and release the Band button as needed so that DAB mode is selected on the display.
3. If this is the first time the digital receiver is used a full scan of the DAB channels in your country will be carried out. The display will show “DAB” for a few seconds. (If the digital receiver has been used before the last used station will be selected).
4. The first station in the list of stations found during the scanning process will be played. The display will show the station name.
5. If no signals are found, the digital receiver will show “OFF AIR” and it may be necessary to relocate your digital receiver to a position giving better reception, and then repeat the scan following above procedure.

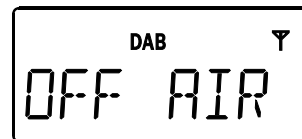
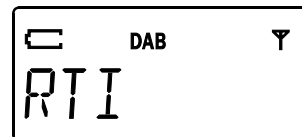

Selecting a DAB radio station

1. Press the Standby button to switch on your digital receiver. The display will show "DAB" for a few seconds.
2. Press the Band button to select DAB radio mode. The display normally shows the name of the current station selected.
3. Rotate the Tuning control to access the radio station list and to scroll through the list of available stations. Stop rotating the Tuning control when you find the station that you wish to hear.
4. Press and release the Tuning control to cause the digital receiver to tune to the chosen station. The display may show "TUNING" while your digital receiver finds the new station.
5. Adjust the Volume control to set the sound level as needed.

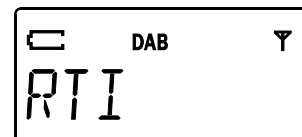

Secondary services

1. Certain radio stations have one or more secondary services associated with them. If a station has a secondary service associated with it then the secondary service will then appear immediately after the primary service as you rotate the Tuning control.
2. Most secondary services do not broadcast continually and if the selected service is not available, the radio will re-tune to the associated primary service.

Display modes – DAB

Your digital receiver has a range of display options when in DAB mode:

1. Repeatedly press and release the Info button to cycle through the different options.

- | | |
|------------------------|---|
| a. Station name | Displays the name of the station being listened to. |
| b. Scrolling Text | Displays scrolling text messages such as the artist or track name, phone in number, website address, etc. |
| c. Program Type | Displays the type of station being listened to such as Pop, Classic, News, etc. |
| d. Multiplex Name | Displays the name of the DAB multiplex to which the current station belongs. |
| e. Time | Display the current time |
| f. Date | Display the current date |
| g. Frequency & Channel | Display the frequency and channel number for the current DAB radio station |
| h. Bit Rate | Display the digital bit rate for the station being listened to |
| i. Signal bar | Display the signal strength for the station being listened to |

The display will revert to a conventional time display 10 seconds after the last button pressed except when displaying scrolling text.

A signal strength indicator is always shown in the display on the upper right corner.

If the currently tuned station has been stored as a preset, then the preset number will also be shown.

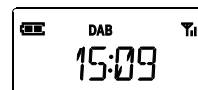
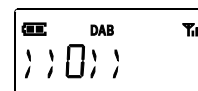
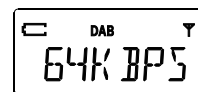
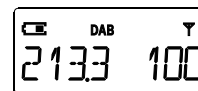
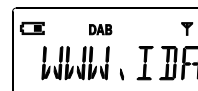
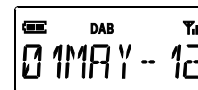
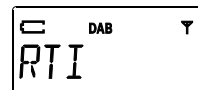

Finding new stations – DAB

Should you wish to use your digital receiver for DAB reception in a new location, or if no station were detected during the initial scan, you can follow this procedure to allow your digital receiver to find out which DAB radio stations are available.

1. With the unit in DAB mode press and release the Auto-tune button. The digital receiver will carry out a full scan of the entire DAB frequencies in your country.
2. As stations are found the station counter on the right-hand side of the display will show the total numbers of DAB stations in your area, and the stations will be added to the list.

Manual Tuning - DAB

Manual tuning allows you to tune directly to the various DAB Band III channels. DAB Band III channels are located in the range 5A to 13F.

1. Press and hold the Info button to enter Advanced Information so that the display shows “MANUAL”.
2. Press and release the Tuning control to enter the Manual menu.
3. Rotate the Tuning control to select the required DAB channel.
4. Press and release the Tuning control to select the channel. If a signal is present, this will be indicated on a signal strength display. The minimum signal marker (0) shows the minimum signal strength needed for good DAB reception. The signal indicator chevrons go up or down showing the changing signal strength as you adjust the wire aerial or your digital receiver.
5. Any new stations that are found are automatically added to the stored list of stations.
6. Press and release the Tuning control to return to normal tuning mode.

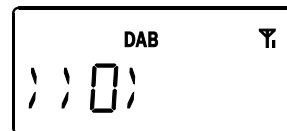
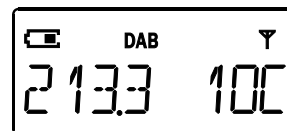
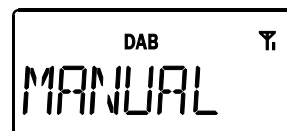
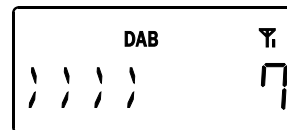
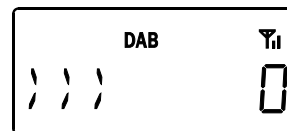
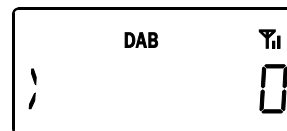

Dynamic Range Control (DRC) settings – DAB

Dynamic Range Control (also known as DRC) can make quieter sounds easier to hear when your radio is used in a noisy environment.

This function is only for the DAB waveband.

1. Press the Standby button to switch on your digital receiver.
2. Press the Band button as needed to select the DAB radio mode.
3. Press and hold the Info button to enter the Advanced Information menu so that “MANUAL” appears on the display.
4. Rotate the Tuning control until the display shows “DRC VAL”.
5. Press and release the Tuning control to enter the DRC adjustment mode.
6. Rotate the Tuning knob to select the required DRC setting (the default is 0).
DRC 0 DRC is switched off, Broadcast DRC will be ignored.
DRC 1/2 DRC level is set to 1/2 that sent by broadcaster.
DRC 1 DRC is set as sent by broadcaster.
7. Press and release the Tuning control to confirm the setting. The display will then return to the previous radio display mode.

Note:

Not all DAB broadcasts are able to use the DRC function. If the broadcast does not support DRC, then the DRC setting in the radio will have no effect.

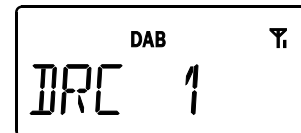
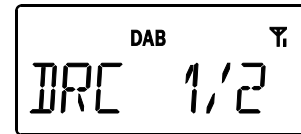
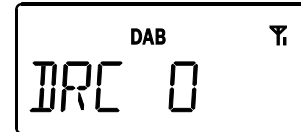
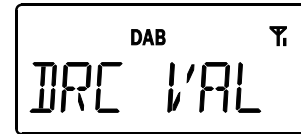

Operating your digital receiver – Search tuning FM

1. Press the Standby button to switch on your digital receiver.
2. Press the Band button as needed until the FM band is selected.
3. Press and release the Auto-tune button to carry out an auto-tune. Your digital receiver will scan up the FM band from the currently displayed frequency and will stop scanning automatically when it finds a station of sufficient strength. To scan down the FM band, press and hold the Auto-tune button.
4. To find more FM stations press and release the Auto-tune button to repeat the scan operation as DAB stations before.
5. When the end of the waveband is reached your digital receiver will recommence tuning from the opposite end of the waveband.
6. Use the Volume control to adjust the sound level as required.

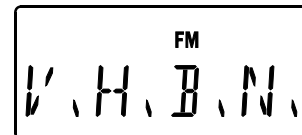

Manual tuning – FM

1. Press the Standby button to switch on your digital receiver.
2. Press and release the Band button to select FM radio mode.
3. Rotate the Tuning control to tune to a station. The frequency will change in steps of 50kHz.
4. When the end of the waveband is reached your digital receiver will recommence tuning from the opposite end of the waveband.
5. Use the Volume control to adjust the sound level as required.

Display modes – FM

Your digital receiver has a range of display options for FM radio mode.

1. Repeatedly press and release the Info button to cycle through the different options.

- | | |
|-------------------|---|
| a. Frequency | Displays the frequency of the FM signal. |
| b. Station name | Displays the name of the station being listened to |
| c. Program type | Displays the type of station being listened to such as Pop, Classic, News, etc. |
| d. Scrolling text | Displays text messages such as new items etc. |
| e. Time | Displays the current time |
| f. Date | Displays the current date |

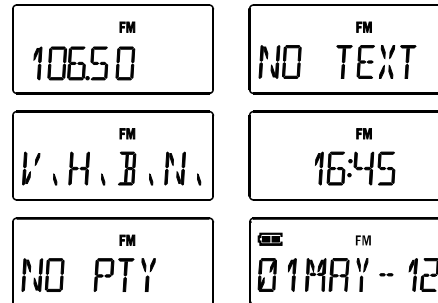

Note:

If no RDS information is available, then the digital receiver will only be able to display the frequency. There will be no text or program type information available under these conditions.

The digital receiver only provides displays when there is information available. So if there is no text, for example, that display is not available.

FM stereo / mono

If the FM radio station being listened to has a weak signal some hiss may be audible. It is possible to reduce this hiss by forcing the radio to play the station in mono rather than Auto (stereo).

1. Press the Band button as needed to select the FM radio mode display and tune to the required FM station as previously described.
2. Press and hold the Info button to enter the advanced information setting.
3. Rotate the Tuning control to choose the 'Audio' option and then press the same button to select the option.
4. Rotate the Tuning control to choose the option of 'AUTO' or 'MONO'. Press the Tuning Control to select your desired option.

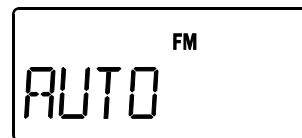
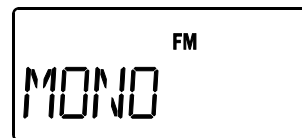

Operating your digital receiver – Search tuning FM

1. Press the Standby button to switch on your digital receiver.
2. Press the Band button as needed until the AM band is selected.
3. Press and release the Auto-tune button to carry out an auto-tune. Your digital receiver will scan up the AM band from the currently displayed frequency and will stop scanning automatically when it finds a station of sufficient strength. To scan down the AM band, press and hold the Auto-tune button.
4. To find more AM stations press and release the Auto-tune button to repeat the scan operation as DAB stations before.
5. When the end of the waveband is reached your digital receiver will recommence tuning from the opposite end of the waveband.
6. Use the Volume control to adjust the sound level as required.

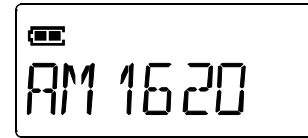

Manual tuning – AM

1. Press the Standby button to switch on your digital receiver.
2. Press and release the Band button to select AM radio mode.
3. Rotate the Tuning control to tune to a station.
4. When the end of the waveband is reached your digital receiver will recommence tuning from the opposite end of the waveband.
5. Use the Volume control to adjust the sound level as required.

Display modes – AM

Your digital receiver has a range of display options for FM radio mode.

1. Repeatedly press and release the Info button to cycle through the different options.
 - a. Frequency Displays the frequency of the FM signal.
 - b. Time Displays the current time
 - c. Date Displays the current date

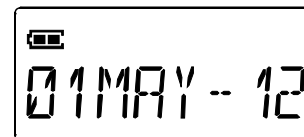
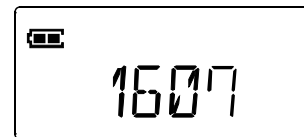
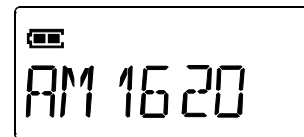

AM range setting

1. Press and hold the Info button to enter the Advanced information setting.
2. Rotate the Tuning control until the 'AM RANGE' is shown on the display. Press the Tuning control to select the option.
3. There are 3 AM step options as below, rotate the tuning control to choose the suitable AM step and then press the Tuning control to select the option.

522-1710 (9k for Australian version)

520-1710 (10k for European version)

522-1629 (9k for European version)

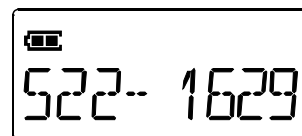
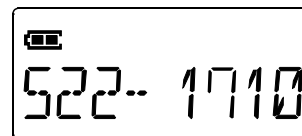
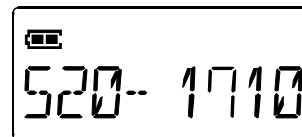

Presetting stations in DAB/ FM/ AM modes

There are 10 memory presets each for DAB, FM and AM radio. Apart from the 10 presets, there are 5 my favorite station memories available. They are used the same way for each waveband.

1. Press the Standby button to switch on your digital receiver.
2. Press the Band button to select the desired waveband. Tune to the required radio station as previously described.
3. Press and hold down the required favorite station number (1 to 5) until the display shows " m1 saved". The station will be stored using the chosen number. Repeat this procedure for the remaining favorite stations as you wish.
4. To store the station in the 10 memory presets, press and hold the Preset button until 'EMPTY 01' is flashing on the screen.
5. Rotate the Tuning control to select the required preset station number. Press and release the Tuning control until the display shows, such as "06 SAVED".
6. Preset memories which have already been stored may be overwritten by following the above procedure if required.

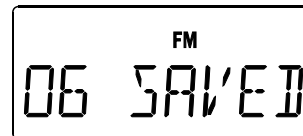
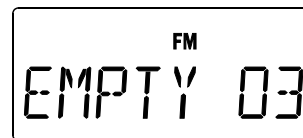
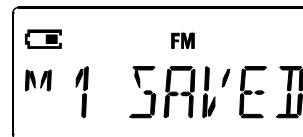

Recalling a preset in DAB/ FM/ AM modes

1. Press the Standby button to switch on your digital receiver.
2. Select the required waveband by pressing the Band button.
3. To tune to one of the 5 my favorite stations stored in my favorite stations, press and release the my favorite station button
4. Momentarily press the required main Preset button to cause your digital receiver to tune to one of the stations stored in the 10 main presets.
5. Rotate the Tuning control to scroll through the preset station list, and then press and release the Tuning control to select the desired preset station. Your digital receiver will tune to the chosen preset station stored in the preset memory.

Clock and Alarms

Automatically updating the clock

Your digital receiver will normally update the clock automatically when tuning to the radio broadcast. After a power failure the digital receiver will then set its clock the next time that you turn on the digital receiver in DAB or FM mode. When the digital receiver is in Standby mode, the clock will be automatically synchronized with DAB radio.

1. Press and hold the Menu/ Alarm button to access the menu setting.
2. Rotate the Tuning control till the 'CLOCK' shown on the display. Press the Tuning control to access the setting.
3. Rotate the Tuning control to select option of 'AUTO CLK'. Press the Tuning control to confirm the setting.

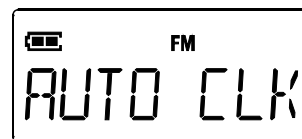

Manually setting the clock

1. Press and hold the Menu/ Alarm button to access the menu setting.
2. Rotate the Tuning control till the 'CLOCK' shown on the display. Press the Tuning control to access the setting.
3. Rotate the Tuning control to select option of 'MANUAL' shown on the display. Press the Tuning control to access the setting.
4. The day setting on the display will begin flashing. Rotate the Tuning control to select the desired date, and press the Tuning control to confirm the setting. Then rotate the Tuning control to select the desired month, and press the Tuning control to confirm the setting. Then rotate the Tuning control to select the desired year, and press the Tuning control to confirm the setting.
5. The hour setting on the display will begin flashing. Rotate the Tuning control to select the desired hour, and press the Tuning control to confirm the setting. Then rotate the Tuning control to select the desired minutes, and press the Tuning control to confirm the setting.



Setting the time format

The clock display used in stand-by mode and on the playing mode screens can be set to 12 or 24 hour format. The selected format is then also used when setting the alarms.

1. With your digital receiver switched on, press and hold the Menu button until "ALARM 1" is flashing on the screen.
2. Rotate the Tuning control until "TIME FMT" shows on the display. Press the Tuning control to enter the system settings menu.
3. Rotate the Tuning control to select either 12 or 24 hour format. Press and release the Tuning control to confirm your choice of clock format. The display will then revert to the previous menu.

If the 12 hour clock format is chosen, the digital receiver will then use the 12 hour clock for the setting of alarms, and will display a 12 hour clock for the setting of alarms, and will display a 12 hour clock with an AM or PM indicator when in stand-by mode.

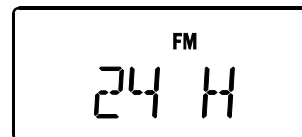
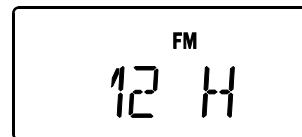

Setting the date format

1. With your digital receiver switched on, press and hold down the Menu button to access the menu setting.
2. Rotate the Tuning control until "DATE FMT" shows on the display. Press and release the Tuning control to enter the date format setting.
3. Rotate the Tuning control to select the required date format. Press and release the Tuning control to confirm your choice of date format. The display will then revert to the previous menu.

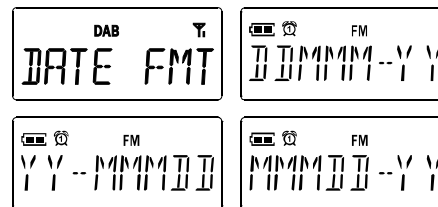

Setting the alarm clock

Your DPR-45 digital receiver has two alarms which can each be set to wake you to AM, DAB, FM radio or buzzer alarm.

The alarms may be set while the unit is in standby mode or while playing. The alarm clock setting will not function when the display appears NO CLOCK.

1. Before setting an alarm ensure that the clock time is set. Press and hold the Menu button.
2. Rotate the Tuning control to select the required alarm, 1 or 2. Press and release the Tuning control to enter the alarm setting.
3. Rotate the Tuning control to choose whether to set the alarm to On or Off. If you decide to abort alarm setting, choose Back and press the Tuning control.
4. Press and release the Tuning control. If the previous selection was to switch on the alarm, then alarm time setting will show on the display and the Alarm hour digits will flash. If Off was selected, the unit will exit the alarm menu.

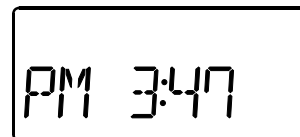
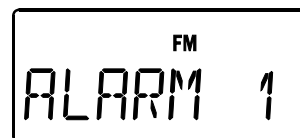

5. Rotate the Tuning control to choose the alarm hour and then press and release the Tuning control to enter the hour setting. The alarm minute digits will then flash on the display.
6. Rotate the Tuning control to choose the alarm minute and then press and release the Tuning control to enter the minute setting.
7. Rotate the Tuning control to choose the required alarm mode, and then press and release the Tuning control to confirm the setting.
8. Rotate the Tuning control to select the required alarm frequency option when radio mode is selected. The display will show the frequency options for the alarm. The alarm options are as follows:
 - ONCE – the alarm will sound once
 - DAILY – the alarm will sound everyday
 - WEEKDAYS – the alarm will sound on weekdays only
 - WEEKENDS – the alarm will sound only at weekendsPress the Tuning control to confirm the setting.
9. Based on your step 7 selection, the alarm can be set to buzzer, DAB radio, AM or FM radio. When DAB mode is selected, the radio alarm is set to the station most recently listened to. When the buzzer is your selection, you will be asked to set your buzzer volume. When the AM/ FM radio mode is chosen, you will be asked to select a station to wake you up.
Note: When the digital receiver is set to wake by DAB, FM, AM radio, the alarm volume will be the volume previously listened to.
10. The alarm has now been set. “SAVED” will show on the display, and then will revert to previous mode.
11. To view an alarm setting press and release the Menu button and the display will show “Alarm 1”. Press and release the Tuning control to enter the Alarm 1 setting, and repeatedly press and release the Tuning control to view through the alarm details.
Active alarms are shown using small alarm indicator at the top of the playing displays and on the clock display when in stand-by.



ONCE



DAILY



WEEKDAYS



WEEKENDS



 SAVED

When the alarm sounds

The alarm icon will flash at the display when an alarm is sounding. To cancel an alarm, press the Standby button to return to Stand-by mode.

When the buzzer alarm activates, the alarm will start softly and gradually increase in level. It will sound for 1 minute and silence for 1 minute at the selected time in repetition for up to 30 minutes unless cancelled. The digital receiver will sound at the selected time for up to 60 minutes for other alarm types.

Disabling alarms

1. To disable a single alarm enters the alarm setup menu and rotate the Tuning control until the desired alarm is showed on the display. Press the Tuning control to enter the alarm setting menu.
2. Rotate the Tuning control until "OFF" is showed on the display, and press and release the Tuning control to confirm the setting.
3. The display will return to previous mode and the chosen alarm will now be disabled.

Note: To cancel a sounding alarm, simply press the Standby button.

Snooze

1. When the alarm sounds, press any button other than the Standby button will silence the alarm for five minutes. The snooze symbol will appear in the display.
2. To cancel the snooze timer while the alarm is suspended, press the Standby button.

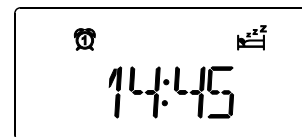
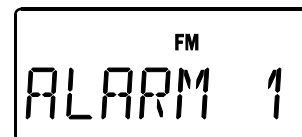

Sleep timer

Your digital receiver can be set to turn off after a preset time has elapsed. The sleep timer setting can be adjusted between 15, 30, 60, 90 and 120 minutes.

1. To use the sleep timer, press and release the Sleep timer button to enter the sleep timer setting. "Sleep 15" will appear on the display.
2. Rotate the Tuning control to select the desired sleep time. Your digital receiver will switch off after the preset sleep time has finished.
An active sleep timer is shown using a small sleep timer / snooze indicator at the top of the playing displays.
3. Use the OFF option to cancel the sleep function. To cancel the sleep function before the preset time has elapsed, either to set the sleep time to off or press the Standby button to turn the unit off manually.

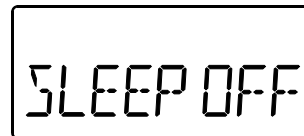
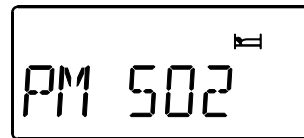
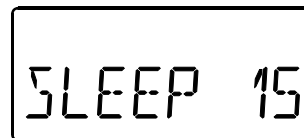

Timer function

1. Press and release the NAP button to enter timer setting and rotate the Tuning control to adjust the minute setting during 1 and 120 minutes with 1 minute interval.
2. Press and release the Tuning control to finish the setting and the timer will start to count down, meanwhile the display will show the remaining minutes. The countdown display will become normal display after 10 seconds.
3. Press and release the NAP button to view the remaining time for an active timer setting. To cancel the function when countdown is progressing, press and hold the NAP button until the timer indicator disappears.
4. Rotate the Tuning control while the display shows the remaining time of countdown to adjust the required timer setting again.

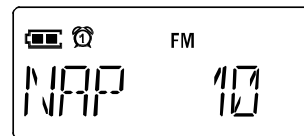

Note: the digital receiver will sound for 3 minutes when an active timer finishes its countdown.

Display and Audio

Brightness control

The brightness of the display when the unit is in standby mode may be adjusted. If you use the unit in the bedroom, you may prefer a lower standby brightness level than the standard setting.

1. Press the Backlight button so that the display shows for example "LIGHT 4".
2. Press the Backlight button one more time to change the standby brightness level. The backlight level will change at the same time so that you can see the effect of the change. The default setting after a system reset is 3. Possible brightness values range from 1 – 7.



Headphone socket

A 3.5mm stereo Headphone Socket is provided on the right hand side of your digital receiver for use with headphones. Inserting a plug automatically mutes the internal loudspeaker.

IMPORTANT:

Excessive sound pressure from earphones and headphones can cause hearing loss.

Information

System reset

If your radio fails to operate correctly, or some digits on the display are missing or incomplete carry out the following procedure.

1. Press and hold the Info button to enter Advanced Information.
2. Rotate the Tuning button until the display shows "FACTORY". Press and release the Tuning control so that the display shows "RESET".
3. Press and release the Tuning control again to confirm the reset operation. A full reset will be performed. The station list and presets will be set to empty. Alarms will be cancelled and timer and sleep timer settings will be set to their default values. The display will show "NO CLOCK" and after a few seconds a station scan search will be performed automatically.

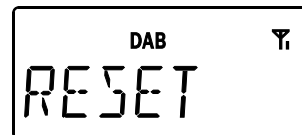

Software version display

1. Press and hold the Info button to enter the Advanced Information.
2. Rotate the Tuning control until the display shows "SW VER". Press the Tuning control again to show your digital receiver's software information.
3. After a few seconds your digital receiver will return to the normal radio display mode.

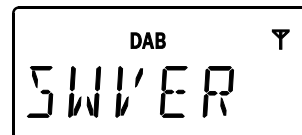

Key lock function

The key lock function is used to prevent unintentional operation of the radio.

1. Key lock switch is located on the panel on the right hand side of the radio. When the key lock switch is set to LOCK, every button will be disabled. Display will show "Lock"
2. To disable the key lock function switch the key lock button to off position. The key lock function will be disabled.

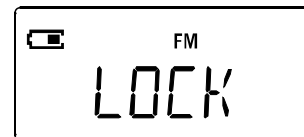

USB socket for software upgrade

Software updates for your radio may be available in the future.

As software updates become available software and information on how to update your radio can be found at

<http://sg.sangean.com.tw/first/first.asp>

<http://www.sangean.eu/first/first.asp>

www.sangean.com.au.

For more information, please contact our Head Office by sending an email to info@sangean.com

1. Press and hold the Info button to enter the Advanced information in any wave band or in standby mode.
2. Rotate the Tuning control until the display shows 'UPGRADE'. Press the Tuning control to enter the setting.
The default setting is 'NO'. Otherwise, rotate the Tuning control to choose 'YES' and press the Tuning control to select the option. The display will show 'WAIT USB'.
3. Plug the USB into the USB socket in the rear of the unit. When the device is detected, the display will show 'DOWNLOAD' and the unit will restart again.

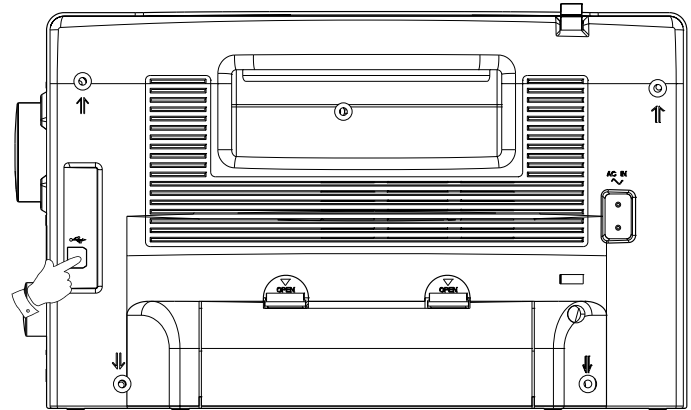

Specifications

Power Requirements

Mains AC IN 230-240 V

Frequency Range

FM: 87.5 – 108 MHz

AM:

9K European version: 522-1629 KHz

Australian version: 522-1710 KHz

10K 520-1710 KHz

Channel Block

DAB (BAND III) 5A – 13F

Battery

4 X 1.5V Size "D" / UM-1 / R20

Circuit Features

Loudspeaker	5" 4 Ω
Output Power	1 Watt
Headphone socket	3.5 mm dia
Aerial System	FM telescopic aerial DAB telescopic aerial AM Ant Bar



If at any time in the future you should need to dispose of this product please note that: Waste electrical products should not be disposed of with household waste. Please recycle where facilities exist. Check with your Local Authority or retailer for recycling advice. (Waste Electrical and Electronic Equipment Directive)