

# IEC Inlet Filters FN 280

## Compact Filtered Power Entry Module

**SCHAFNER**  
energy efficiency and reliability



- Rated currents up to 10A
- Single or dual-fuse holder
- Fuses Ø5 x 20mm
- 2-pole rocker switch
- General purpose application
- Optional earth line choke (E type)
- Optional medical version (B type)

### Approvals



**ROHS**

### Technical specifications

Maximum continuous operating voltage:	250VAC, 50/60Hz
Operating frequency:	50 to 400Hz
Rated currents:	1 to 10A @ 40°C max.
High potential test voltage:	P → PE 2000VAC for 2 sec (standard types) P → PE 2500VAC for 2 sec (B types)
	P → N 760VAC for 2 sec
Protection category:	IP40 according to IEC 60529
Temperature range (operation and storage):	-25°C to +85°C (25/85/21)
Design corresponding to:	UL 1283, CSA 22.2 No. 8 1986, IEC/EN 60939
Flammability corresponding to:	UL 94V-2 or better
MTBF @ 40°C/230V (Mil-HB-217F):	1,500,000 hours
Fuse holder:	1 or 2 fuses (Ø5 x 20mm)
Marking:	≡ max. 250V ~ (text is print. below fuse symbol)
Rocker switch description:	
Function:	2-pole, dark not illuminated Marking I - 0
Electrical specifications:	Inrush current 82A 6,000 on-off operations according to UL 1054, TV 5 10,000 on-off operations according to ENEC
Mechanical life:	50,000 cycles
Switch ratings:	
USA (UL) and Canada (C-UL):	10A, 125VAC; 10A, 250VAC; 1/3HP
Europe (ENEC):	10A (4A), 250VAC*

\* Value in () relates to the inductive current charge:  $\cos \varphi = 0.65$

### Typical electrical schematic

#### Standard types

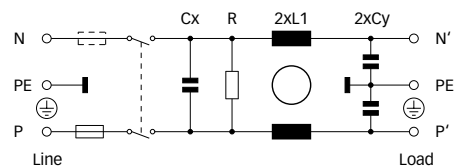

#### E types

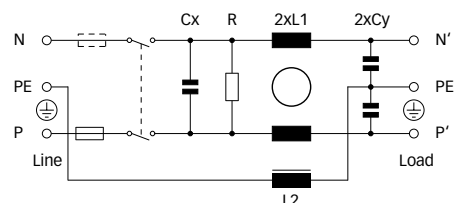

The FN 280 power entry module combines an IEC inlet, a mains filter with single or dual-fuse holder and a 2-pole rocker switch in a small form factor. Choosing FN 280 product line brings you the rapid availability of a standard filter associated with the necessary safety acceptances. Standard IEC connector filters are a practical solution helping you to pass EMI system approval in a short time. A wide selection on amperage ratings, fuse options, mounting possibilities and filters for medical applications are designed to offer you the desired solution.

### Features and benefits

- High conducted attenuation performance, based on chokes with high saturation resistance and excellent thermal behavior.
- Rear/front or snap-in mounting.
- Single or dual-fuse holder.
- 2-pole rocker switch.
- Custom-specific versions are available on request.

### Typical applications

- Portable electrical and electronic equipment
- Consumer goods
- EDP and office equipment
- Single-phase power supplies, switch-mode power supplies
- Test and measurement equipment
- Medical equipment

Filter selection table

Filter	Rated current @ 40°C (25°C) [A]	Leakage current* @ 230VAC/50Hz [µA]	Inductance		Capacitance		Resistance R [kΩ]	Output connections 	Fuses** [Qty]	Weight [g]
			L1 [mH]	L2 [mH]	Cx [nF]	Cy [nF]				
FN 281-1-06	1 (1.2)	373	7.5		220	2.2	1000	-06	1	140
FN 281-2-06	2 (2.4)	373	2		220	2.2	1000	-06	1	140
FN 281-4-06	4 (4.8)	373	1		220	2.2	1000	-06	1	140
FN 281-6-06	6 (7.2)	373	0.45		220	2.2	1000	-06	1	140
FN 281-10-06	10 (11.6)	373	0.34		220	2.2	1000	-06	1	140
FN 282-1-06	1 (1.2)	373	7.5		220	2.2	1000	-06	2	90
FN 282-2-06	2 (2.4)	373	2		220	2.2	1000	-06	2	90
FN 282-4-06	4 (4.8)	373	1		220	2.2	1000	-06	2	90
FN 282-6-06	6 (7.2)	373	0.45		220	2.2	1000	-06	2	90
FN 282-10-06	10 (11.6)	373	0.34		220	2.2	1000	-06	2	140
FN 283-1-06	1 (1.2)	373	7.5		220	2.2	1000	-06	1	140
FN 283-2-06	2 (2.4)	373	2		220	2.2	1000	-06	1	140
FN 283-4-06	4 (4.8)	373	1		220	2.2	1000	-06	1	140
FN 283-6-06	6 (7.2)	373	0.45		220	2.2	1000	-06	1	140
FN 283-10-06	10 (11.6)	373	0.34		220	2.2	1000	-06	1	140
FN 284-1-06	1 (1.2)	373	7.5		220	2.2	1000	-06	2	90
FN 284-2-06	2 (2.4)	373	2		220	2.2	1000	-06	2	90
FN 284-4-06	4 (4.8)	373	1		220	2.2	1000	-06	2	90
FN 284-6-06	6 (7.2)	373	0.45		220	2.2	1000	-06	2	90
FN 284-10-06	10 (11.6)	373	0.34		220	2.2	1000	-06	2	140
FN 285-1-06	1 (1.2)	373	7.5		220	2.2	1000	-06	1	140
FN 285-2-06	2 (2.4)	373	2		220	2.2	1000	-06	1	140
FN 285-4-06	4 (4.8)	373	1		220	2.2	1000	-06	1	140
FN 285-6-06	6 (7.2)	373	0.45		220	2.2	1000	-06	1	140
FN 285-10-06	10 (11.6)	373	0.34		220	2.2	1000	-06	1	140
FN 286-1-06	1 (1.2)	373	7.5		220	2.2	1000	-06	2	90
FN 286-2-06	2 (2.4)	373	2		220	2.2	1000	-06	2	90
FN 286-4-06	4 (4.8)	373	1		220	2.2	1000	-06	2	90
FN 286-6-06	6 (7.2)	373	0.45		220	2.2	1000	-06	2	90
FN 286-10-06	10 (11.6)	373	0.34		220	2.2	1000	-06	2	140
FN 283E-1-06	1 (1.2)	373	7.5	0.4	220	2.2	1000	-06	1	140
FN 283E-2-06	2 (2.4)	373	2	0.4	220	2.2	1000	-06	1	140
FN 283E-4-06	4 (4.8)	373	1	0.4	220	2.2	1000	-06	1	140
FN 283E-6-06	6 (7.2)	373	0.45	0.4	220	2.2	1000	-06	1	140
FN 284E-1-06	1 (1.2)	373	7.5	0.4	220	2.2	1000	-06	2	90
FN 284E-2-06	2 (2.4)	373	2	0.4	220	2.2	1000	-06	2	90
FN 284E-4-06	4 (4.8)	373	1	0.4	220	2.2	1000	-06	2	90
FN 284E-6-06	6 (7.2)	373	0.45	0.4	220	2.2	1000	-06	2	90
FN 282B-1-06	1 (1.2)	2	7.5		220		1000	-06	2	90
FN 282B-2-06	2 (2.4)	2	2		220		1000	-06	2	90
FN 282B-4-06	4 (4.8)	2	1		220		1000	-06	2	90
FN 282B-6-06	6 (7.2)	2	0.45		220		1000	-06	2	90
FN 282B-10-06	10 (11.6)	2	0.34		220		1000	-06	2	140
FN 284B-1-06	1 (1.2)	2	7.5		220		1000	-06	2	90
FN 284B-2-06	2 (2.4)	2	2		220		1000	-06	2	90
FN 284B-4-06	4 (4.8)	2	1		220		1000	-06	2	90
FN 284B-6-06	6 (7.2)	2	0.45		220		1000	-06	2	90
FN 284B-10-06	10 (11.6)	2	0.34		220		1000	-06	2	140
FN 286B-1-06	1 (1.2)	2	7.5		220		1000	-06	2	90
FN 286B-2-06	2 (2.4)	2	2		220		1000	-06	2	90
FN 286B-4-06	4 (4.8)	2	1		220		1000	-06	2	90
FN 286B-6-06	6 (7.2)	2	0.45		220		1000	-06	2	90
FN 286B-10-06	10 (11.6)	2	0.34		220		1000	-06	2	140

\* Maximum leakage under normal operating conditions. Note: if the neutral line is interrupted, worst case leakage could reach twice this level.

\*\* Filters are delivered without fuse.

**Product selector**

FN 28xx-yy-zz

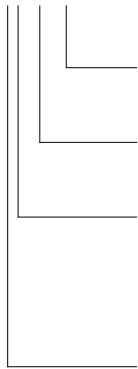

- 06: Faston 6.3 x 0.8mm (spade/soldering)
- 1 to 10: Rated current
- Blank: Standard version
- E: Optional earth line choke
- B: Medical version (with bleed resistor and without Y2-capacitor)
- 1: Flange mounting version top/bottom, single-fuse
- 2: Flange mounting version top/bottom, dual-fuse
- 3: Flange mounting version left/right, single-fuse
- 4: Flange mounting version left/right, dual-fuse
- 5: Snap-in version, single-fuse
- 6: Snap-in version, dual-fuse

For example: FN 281-6-06, FN 283B-04-06, FN 283E-1-06

**Typical filter attenuation**

Per CISPR 17; A = 50Ω/50Ω sym; B = 50Ω/50Ω asym; C = 0.1Ω/100Ω sym; D = 100Ω/0.1Ω sym

1A types

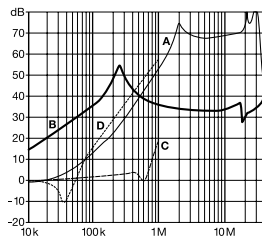

2 to 6A types

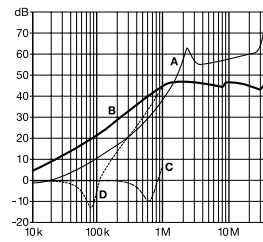

10A types

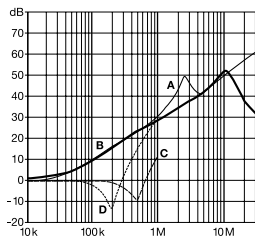

**Mechanical data**

FN 281 / FN 282

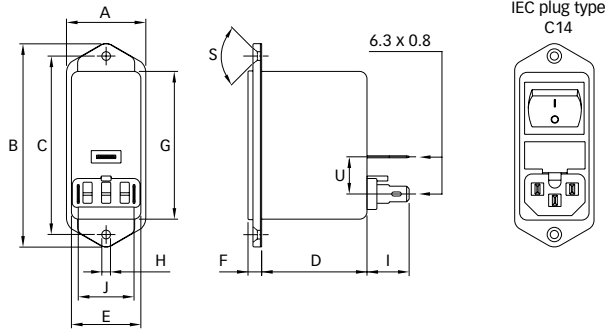

FN 283 / FN 284

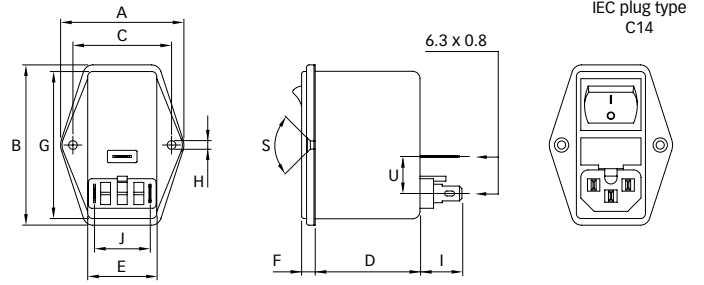

FN 285 / FN 286

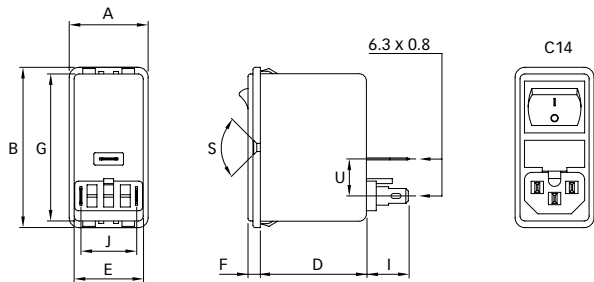

Panel cut out

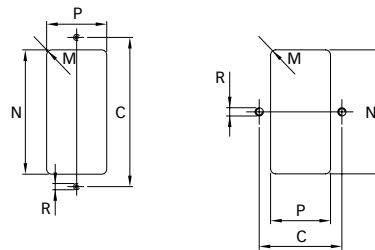

**Dimensions**

	FN 281	FN 282	FN 283	FN 284	FN 285	FN 286	Tolerances
<b>A</b>	32	32	50	50	32	32	±0.3
<b>B</b>	82	82	65	65	65	65	±0.3
<b>C</b>	72	72	40	40			±0.1
<b>D</b>	43.1	43.1	43.1	43.1	43.6	43.6	±0.3
<b>E</b>	28.5	28.5	28.5	28.5	28.5	28.5	±0.25
<b>F</b>	5.5	5.5	5.5	5.5	5	5	±0.3
<b>G</b>	59.95 max.	59.95 max.	59.95 max.	59.95 max.	59.95 max.	59.95 max.	
<b>H</b>	Ø3.5	Ø3.5	Ø3.3	Ø3.3			
<b>I</b>	13.4	16.2	13.4	16.2	13.9	16.7	±0.3
<b>J</b>	22.5	22.5	22.5	22.5	22.5	22.5	
<b>M</b>	R ≤ 2.5	R ≤ 2.5	R ≤ 2.5	R ≤ 2.5	R ≤ 2.5	R ≤ 2.5	
<b>N</b>	60	60	60	60	61.5 +0.2/-0*	61.5 +0.2/-0*	+0.5/-0
<b>P</b>	29	29	29	29	29	29	+0.5/-0
<b>R</b>	M3	M3	M3	M3			
<b>S</b>	90°	90°	90°	90°			

\* For a panel thickness between 0.8 and 3mm  
 All dimensions in mm; 1 inch = 25.4mm  
 Tolerances according: ISO 2768-m / EN 22768-m

**Headquarters, global innovation  
and development center**

**Schaffner Group**  
Nordstrasse 11  
4542 Luterbach  
Schweiz  
T +41 32 681 66 26  
F +41 32 681 66 30  
info@schaffner.com  
www.schaffner.com

To find your local partner within  
Schaffner's global network, please go to  
[www.schaffner.com](http://www.schaffner.com)

© 2012 Schaffner Group  
Specifications are subject to change  
within notice. The latest version of the  
data sheets can be obtained from the  
website. All trademarks recognized.

Schaffner is an ISO-registered company.  
Its products are designed and  
manufactured under the strict quality  
and environmental requirements of  
the ISO 9001 and ISO 14001 standards.

This document has been carefully  
checked. However, Schaffner does not  
assume any liability for errors or  
inaccuracies.

**Sales and application centers**

**China**  
**Schaffner EMC Ltd. Shanghai**  
T20-3, No 565 Chuangye Road  
Pudong New Area  
Shanghai 201201  
T +86 21 3813 9500  
F +86 21 3813 9501 / 02  
cschina@schaffner.com  
www.schaffner.com

**Finland**  
**Schaffner Oy**  
Sauvonrinne 19 H  
08500 Lohja  
T +358 19 35 72 71  
F +358 19 32 66 10  
finlandsales@schaffner.com

**France**  
**Schaffner EMC S.A.S.**  
112, Quai de Bezons  
95103 Argenteuil  
T +33 1 34 34 30 60  
F +33 1 39 47 02 28  
francesales@schaffner.com

**Germany**  
**Schaffner Deutschland GmbH**  
Schoemperlenstrasse 12B  
76185 Karlsruhe  
T +49 721 56910  
F +49 721 569110  
germanysales@schaffner.com

**Italy**  
**Schaffner EMC S.r.l.**  
Via Galileo Galilei, 47  
20092 Cinisello Balsamo (MI)  
T +39 02 66 04 30 45/47  
F +39 02 61 23 943  
italysales@schaffner.com

**Japan**  
**Schaffner EMC K.K.**  
Mitsui-Seimei Sangenjaya Bldg. 7F  
1-32-12, Kamiyuma, Setagaya-ku  
Tokyo 154-0011  
T +81 3 5712 3650  
F +81 3 5712 3651  
japansales@schaffner.com  
www.schaffner.jp

**Singapore**  
**Schaffner EMC Pte Ltd.**  
Blk 3015A Ubi Road 1  
05-09 Kampong Ubi Industrial Estate  
T +65 6377 3283  
F +65 6377 3281  
singaporesales@schaffner.com

**Spain**  
**Schaffner EMC España**  
Calle Caléndula 93  
Miniparc III, Edificio E  
El Soto de la Moraleja  
Alcobendas  
28109 Madrid  
T +34 618 176 133  
spainsales@schaffner.com

**Sweden**  
**Schaffner EMC AB**  
Turebergstorg 1, 6  
19147 Sollentuna  
T +46 8 5792 1121 / 22  
F +46 8 92 96 90  
swedensales@schaffner.com

**Switzerland**  
**Schaffner EMV AG**  
Nordstrasse 11  
4542 Luterbach  
T +41 32 681 66 26  
F +41 32 681 66 41  
sales@schaffner.ch

**Taiwan**  
**Schaffner EMV Ltd.**  
6th Floor, No 413  
Rui Guang Road  
Neihu District  
Taipei City 114  
T +886 2 87525050  
F +886 2 87518086  
taiwansales@schaffner.com

**Thailand**  
**Schaffner EMC Co. Ltd.**  
Northern Region Industrial Estate  
67 Moo 4 Tambon Ban Klang  
Amphur Muang P.O. Box 14  
Lamphun 51000  
T +66 53 58 11 04  
F +66 53 58 10 19  
thailandsales@schaffner.com

**UK**  
**Schaffner Ltd.**  
5 Ashville Way  
Molly Millars Lane  
Wokingham  
Berkshire RG41 2PL  
T +44 118 9770070  
F +44 118 9792969  
uksales@schaffner.com  
www.schaffner.uk.com

**USA**  
**Schaffner EMC Inc.**  
52 Mayfield Avenue  
Edison, New Jersey 08837  
T +1 732 225 9533  
F +1 732 225 4789  
usasales@schaffner.com  
www.schaffner.com/us