

IEC Inlet Filters FN 280

Compact Filtered Power Entry Module

SCHAFNER
energy efficiency and reliability



- Rated currents up to 10A
- Single or dual-fuse holder
- Fuses Ø5 x 20mm
- 2-pole rocker switch
- General purpose application
- Optional earth line choke (E type)
- Optional medical version (B type)

Approvals



ROHS

Technical specifications

Maximum continuous operating voltage:	250VAC, 50/60Hz
Operating frequency:	50 to 400Hz
Rated currents:	1 to 10A @ 40°C max.
High potential test voltage:	P → PE 2000VAC for 2 sec (standard types) P → PE 2500VAC for 2 sec (B types) P → N 760VAC for 2 sec
Protection category:	IP40 according to IEC 60529
Temperature range (operation and storage):	-25°C to +85°C (25/85/21)
Design corresponding to:	UL 1283, CSA 22.2 No. 8 1986, IEC/EN 60939
Flammability corresponding to:	UL 94V-2 or better
MTBF @ 40°C/230V (Mil-HB-217F):	1,500,000 hours
Fuse holder:	1 or 2 fuses (Ø5 x 20mm)
Marking:	≡ max. 250V ~ (text is print. below fuse symbol)
Rocker switch description:	
Function:	2-pole, dark not illuminated Marking I - 0
Electrical specifications:	Inrush current 82A 6,000 on-off operations according to UL 1054, TV 5 10,000 on-off operations according to ENEC
Mechanical life:	50,000 cycles
Switch ratings:	
USA (UL) and Canada (C-UL):	10A, 125VAC; 10A, 250VAC; 1/3HP
Europe (ENEC):	10A (4A), 250VAC*

* Value in () relates to the inductive current charge: $\cos \varphi = 0.65$

Typical electrical schematic

Standard types

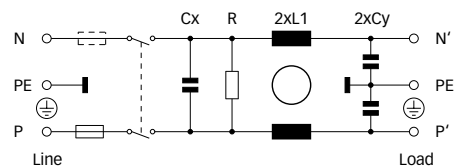

E types

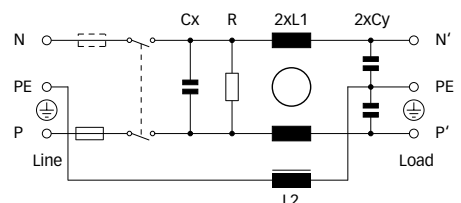

The FN 280 power entry module combines an IEC inlet, a mains filter with single or dual-fuse holder and a 2-pole rocker switch in a small form factor. Choosing FN 280 product line brings you the rapid availability of a standard filter associated with the necessary safety acceptances. Standard IEC connector filters are a practical solution helping you to pass EMI system approval in a short time. A wide selection on amperage ratings, fuse options, mounting possibilities and filters for medical applications are designed to offer you the desired solution.

Features and benefits

- High conducted attenuation performance, based on chokes with high saturation resistance and excellent thermal behavior.
- Rear/front or snap-in mounting.
- Single or dual-fuse holder.
- 2-pole rocker switch.
- Custom-specific versions are available on request.

Typical applications

- Portable electrical and electronic equipment
- Consumer goods
- EDP and office equipment
- Single-phase power supplies, switch-mode power supplies
- Test and measurement equipment
- Medical equipment

Filter selection table

Filter	Rated current @ 40°C (25°C) [A]	Leakage current* @ 230VAC/50Hz [µA]	Inductance		Capacitance		Resistance R [kΩ]	Output connections 	Fuses** [Qty]	Weight [g]
			L1 [mH]	L2 [mH]	Cx [nF]	Cy [nF]				
FN 281-1-06	1 (1.2)	373	7.5		220	2.2	1000	-06	1	140
FN 281-2-06	2 (2.4)	373	2		220	2.2	1000	-06	1	140
FN 281-4-06	4 (4.8)	373	1		220	2.2	1000	-06	1	140
FN 281-6-06	6 (7.2)	373	0.45		220	2.2	1000	-06	1	140
FN 281-10-06	10 (11.6)	373	0.34		220	2.2	1000	-06	1	140
FN 282-1-06	1 (1.2)	373	7.5		220	2.2	1000	-06	2	90
FN 282-2-06	2 (2.4)	373	2		220	2.2	1000	-06	2	90
FN 282-4-06	4 (4.8)	373	1		220	2.2	1000	-06	2	90
FN 282-6-06	6 (7.2)	373	0.45		220	2.2	1000	-06	2	90
FN 282-10-06	10 (11.6)	373	0.34		220	2.2	1000	-06	2	140
FN 283-1-06	1 (1.2)	373	7.5		220	2.2	1000	-06	1	140
FN 283-2-06	2 (2.4)	373	2		220	2.2	1000	-06	1	140
FN 283-4-06	4 (4.8)	373	1		220	2.2	1000	-06	1	140
FN 283-6-06	6 (7.2)	373	0.45		220	2.2	1000	-06	1	140
FN 283-10-06	10 (11.6)	373	0.34		220	2.2	1000	-06	1	140
FN 284-1-06	1 (1.2)	373	7.5		220	2.2	1000	-06	2	90
FN 284-2-06	2 (2.4)	373	2		220	2.2	1000	-06	2	90
FN 284-4-06	4 (4.8)	373	1		220	2.2	1000	-06	2	90
FN 284-6-06	6 (7.2)	373	0.45		220	2.2	1000	-06	2	90
FN 284-10-06	10 (11.6)	373	0.34		220	2.2	1000	-06	2	140
FN 285-1-06	1 (1.2)	373	7.5		220	2.2	1000	-06	1	140
FN 285-2-06	2 (2.4)	373	2		220	2.2	1000	-06	1	140
FN 285-4-06	4 (4.8)	373	1		220	2.2	1000	-06	1	140
FN 285-6-06	6 (7.2)	373	0.45		220	2.2	1000	-06	1	140
FN 285-10-06	10 (11.6)	373	0.34		220	2.2	1000	-06	1	140
FN 286-1-06	1 (1.2)	373	7.5		220	2.2	1000	-06	2	90
FN 286-2-06	2 (2.4)	373	2		220	2.2	1000	-06	2	90
FN 286-4-06	4 (4.8)	373	1		220	2.2	1000	-06	2	90
FN 286-6-06	6 (7.2)	373	0.45		220	2.2	1000	-06	2	90
FN 286-10-06	10 (11.6)	373	0.34		220	2.2	1000	-06	2	140
FN 283E-1-06	1 (1.2)	373	7.5	0.4	220	2.2	1000	-06	1	140
FN 283E-2-06	2 (2.4)	373	2	0.4	220	2.2	1000	-06	1	140
FN 283E-4-06	4 (4.8)	373	1	0.4	220	2.2	1000	-06	1	140
FN 283E-6-06	6 (7.2)	373	0.45	0.4	220	2.2	1000	-06	1	140
FN 284E-1-06	1 (1.2)	373	7.5	0.4	220	2.2	1000	-06	2	90
FN 284E-2-06	2 (2.4)	373	2	0.4	220	2.2	1000	-06	2	90
FN 284E-4-06	4 (4.8)	373	1	0.4	220	2.2	1000	-06	2	90
FN 284E-6-06	6 (7.2)	373	0.45	0.4	220	2.2	1000	-06	2	90
FN 282B-1-06	1 (1.2)	2	7.5		220		1000	-06	2	90
FN 282B-2-06	2 (2.4)	2	2		220		1000	-06	2	90
FN 282B-4-06	4 (4.8)	2	1		220		1000	-06	2	90
FN 282B-6-06	6 (7.2)	2	0.45		220		1000	-06	2	90
FN 282B-10-06	10 (11.6)	2	0.34		220		1000	-06	2	140
FN 284B-1-06	1 (1.2)	2	7.5		220		1000	-06	2	90
FN 284B-2-06	2 (2.4)	2	2		220		1000	-06	2	90
FN 284B-4-06	4 (4.8)	2	1		220		1000	-06	2	90
FN 284B-6-06	6 (7.2)	2	0.45		220		1000	-06	2	90
FN 284B-10-06	10 (11.6)	2	0.34		220		1000	-06	2	140
FN 286B-1-06	1 (1.2)	2	7.5		220		1000	-06	2	90
FN 286B-2-06	2 (2.4)	2	2		220		1000	-06	2	90
FN 286B-4-06	4 (4.8)	2	1		220		1000	-06	2	90
FN 286B-6-06	6 (7.2)	2	0.45		220		1000	-06	2	90
FN 286B-10-06	10 (11.6)	2	0.34		220		1000	-06	2	140

* Maximum leakage under normal operating conditions. Note: if the neutral line is interrupted, worst case leakage could reach twice this level.

** Filters are delivered without fuse.

Product selector

FN 28xx-yy-zz

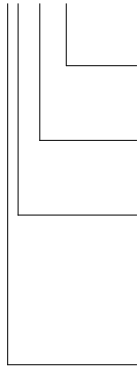

- 06: Faston 6.3 x 0.8mm (spade/soldering)
- 1 to 10: Rated current
- Blank: Standard version
- E: Optional earth line choke
- B: Medical version (with bleed resistor and without Y2-capacitor)
- 1: Flange mounting version top/bottom, single-fuse
- 2: Flange mounting version top/bottom, dual-fuse
- 3: Flange mounting version left/right, single-fuse
- 4: Flange mounting version left/right, dual-fuse
- 5: Snap-in version, single-fuse
- 6: Snap-in version, dual-fuse

For example: FN 281-6-06, FN 283B-04-06, FN 283E-1-06

Typical filter attenuation

Per CISPR 17; A = 50Ω/50Ω sym; B = 50Ω/50Ω asym; C = 0.1Ω/100Ω sym; D = 100Ω/0.1Ω sym

1A types

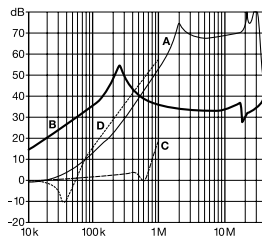

2 to 6A types

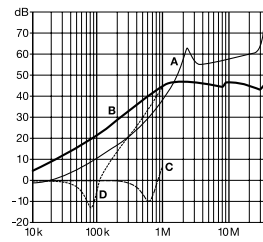

10A types

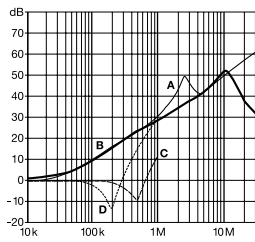

Mechanical data

FN 281 / FN 282

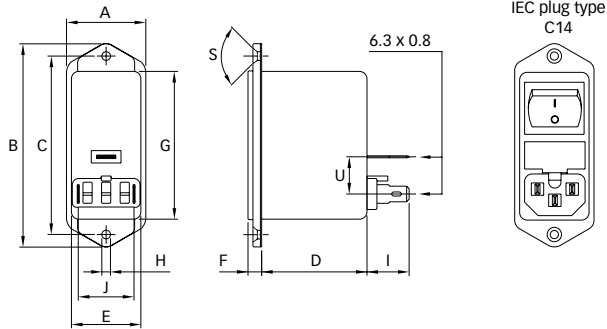

FN 283 / FN 284

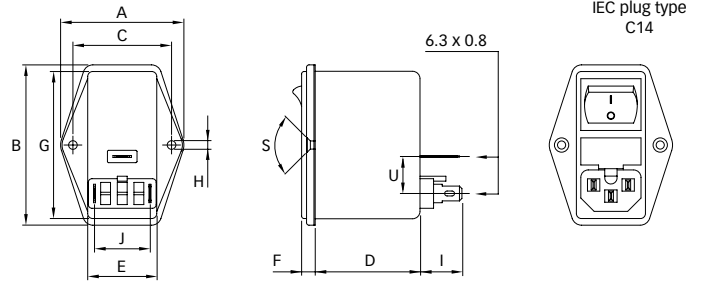

FN 285 / FN 286

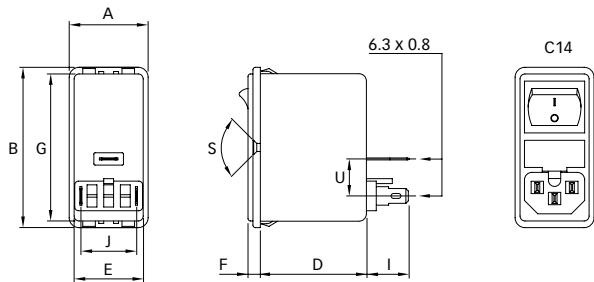

Panel cut out

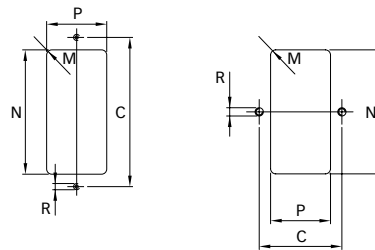

Dimensions

	FN 281	FN 282	FN 283	FN 284	FN 285	FN 286	Tolerances
A	32	32	50	50	32	32	±0.3
B	82	82	65	65	65	65	±0.3
C	72	72	40	40			±0.1
D	43.1	43.1	43.1	43.1	43.6	43.6	±0.3
E	28.5	28.5	28.5	28.5	28.5	28.5	±0.25
F	5.5	5.5	5.5	5.5	5	5	±0.3
G	59.95 max.	59.95 max.	59.95 max.	59.95 max.	59.95 max.	59.95 max.	
H	Ø3.5	Ø3.5	Ø3.3	Ø3.3			
I	13.4	16.2	13.4	16.2	13.9	16.7	±0.3
J	22.5	22.5	22.5	22.5	22.5	22.5	
M	R ≤ 2.5	R ≤ 2.5	R ≤ 2.5	R ≤ 2.5	R ≤ 2.5	R ≤ 2.5	
N	60	60	60	60	61.5 +0.2/-0*	61.5 +0.2/-0*	+0.5/-0
P	29	29	29	29	29	29	+0.5/-0
R	M3	M3	M3	M3			
S	90°	90°	90°	90°			

* For a panel thickness between 0.8 and 3mm
 All dimensions in mm; 1 inch = 25.4mm
 Tolerances according to: ISO 2768-m / EN 22768-m

**Headquarters, global innovation
and development center**

Schaffner Group
Nordstrasse 11
4542 Luterbach
Schweiz
T +41 32 681 66 26
F +41 32 681 66 30
info@schaffner.com
www.schaffner.com

To find your local partner within
Schaffner's global network, please go to
www.schaffner.com

© 2012 Schaffner Group
Specifications are subject to change
within notice. The latest version of the
data sheets can be obtained from the
website. All trademarks recognized.

Schaffner is an ISO-registered company.
Its products are designed and
manufactured under the strict quality
and environmental requirements of
the ISO 9001 and ISO 14001 standards.

This document has been carefully
checked. However, Schaffner does not
assume any liability for errors or
inaccuracies.

Sales and application centers

China
Schaffner EMC Ltd. Shanghai
T20-3, No 565 Chuangye Road
Pudong New Area
Shanghai 201201
T +86 21 3813 9500
F +86 21 3813 9501 / 02
cschina@schaffner.com
www.schaffner.com

Finland
Schaffner Oy
Sauvonrinne 19 H
08500 Lohja
T +358 19 35 72 71
F +358 19 32 66 10
finlandsales@schaffner.com

France
Schaffner EMC S.A.S.
112, Quai de Bezons
95103 Argenteuil
T +33 1 34 34 30 60
F +33 1 39 47 02 28
francesales@schaffner.com

Germany
Schaffner Deutschland GmbH
Schoemperlenstrasse 12B
76185 Karlsruhe
T +49 721 56910
F +49 721 569110
germanysales@schaffner.com

Italy
Schaffner EMC S.r.l.
Via Galileo Galilei, 47
20092 Cinisello Balsamo (MI)
T +39 02 66 04 30 45/47
F +39 02 61 23 943
italysales@schaffner.com

Japan
Schaffner EMC K.K.
Mitsui-Seimei Sangenjaya Bldg. 7F
1-32-12, Kamiyuma, Setagaya-ku
Tokyo 154-0011
T +81 3 5712 3650
F +81 3 5712 3651
japansales@schaffner.com
www.schaffner.jp

Singapore
Schaffner EMC Pte Ltd.
Blk 3015A Ubi Road 1
05-09 Kampong Ubi Industrial Estate
T +65 6377 3283
F +65 6377 3281
singaporesales@schaffner.com

Spain
Schaffner EMC España
Calle Caléndula 93
Miniparc III, Edificio E
El Soto de la Moraleja
Alcobendas
28109 Madrid
T +34 618 176 133
spainsales@schaffner.com

Sweden
Schaffner EMC AB
Turebergstorg 1, 6
19147 Sollentuna
T +46 8 5792 1121 / 22
F +46 8 92 96 90
swedensales@schaffner.com

Switzerland
Schaffner EMV AG
Nordstrasse 11
4542 Luterbach
T +41 32 681 66 26
F +41 32 681 66 41
sales@schaffner.ch

Taiwan
Schaffner EMV Ltd.
6th Floor, No 413
Rui Guang Road
Neihu District
Taipei City 114
T +886 2 87525050
F +886 2 87518086
taiwansales@schaffner.com

Thailand
Schaffner EMC Co. Ltd.
Northern Region Industrial Estate
67 Moo 4 Tambon Ban Klang
Amphur Muang P.O. Box 14
Lamphun 51000
T +66 53 58 11 04
F +66 53 58 10 19
thailandsales@schaffner.com

UK
Schaffner Ltd.
5 Ashville Way
Molly Millars Lane
Wokingham
Berkshire RG41 2PL
T +44 118 9770070
F +44 118 9792969
uksales@schaffner.com
www.schaffner.uk.com

USA
Schaffner EMC Inc.
52 Mayfield Avenue
Edison, New Jersey 08837
T +1 732 225 9533
F +1 732 225 4789
usasales@schaffner.com
www.schaffner.com/us