

**KVMP Switch**  
**CS1708A / CS1716A**  
**User Manual**



## FCC Information

This is an FCC Class A product. In a domestic environment this product may cause radio interference in which case the user may be required to take adequate measures.

This equipment has been tested and found to comply with the limits for a Class A digital device, pursuant to Part 15 of the FCC Rules. These limits are designed to provide reasonable protection against harmful interference when the equipment is operated in a commercial environment. This equipment generates, uses and can radiate radio frequency energy and, if not installed and used in accordance with the instruction manual, may cause harmful interference to radio communications. Operation of this equipment in a residential area is likely to cause harmful interference in which case the user will be required to correct the interference at his own expense.

## RoHS

This product is RoHS compliant.

## SJ/T 11364-2006

The following contains information that relates to China.

部件名称	有毒有害物质或元素					
	铅	汞	镉	六价铬	多溴联苯	多溴二苯醚
电器部件	●	○	○	○	○	○
机构部件	○	○	○	○	○	○

- : 表示该有毒有害物质在该部件所有均质材料中的含量均在SJ/T 11363-2006规定的限量要求之下。
- : 表示符合欧盟的豁免条款, 但该有毒有害物质至少在该部件的某一均质材料中的含量超出SJ/T 11363-2006的限量要求。
- ×: 表示该有毒有害物质至少在该部件的某一均质材料中的含量超出SJ/T 11363-2006的限量要求。



## User Information

---

### Online Registration

Be sure to register your product at our online support center:

International	<a href="http://support.aten.com">http://support.aten.com</a>
North America	<a href="http://www.aten-usa.com/product_registration">http://www.aten-usa.com/product_registration</a>

### Telephone Support

For telephone support, call this number:

International	886-2-8692-6959
China	86-10-5255-0110
Japan	81-3-5615-5811
Korea	82-2-467-6789
North America	1-888-999-ATEN ext 4988
United Kingdom	44-8-4481-58923

### User Notice

All information, documentation, and specifications contained in this manual are subject to change without prior notification by the manufacturer. The manufacturer makes no representations or warranties, either expressed or implied, with respect to the contents hereof and specifically disclaims any warranties as to merchantability or fitness for any particular purpose. Any of the manufacturer's software described in this manual is sold or licensed *as is*. Should the programs prove defective following their purchase, the buyer (and not the manufacturer, its distributor, or its dealer), assumes the entire cost of all necessary servicing, repair and any incidental or consequential damages resulting from any defect in the software.

The manufacturer of this system is not responsible for any radio and/or TV interference caused by unauthorized modifications to this device. It is the responsibility of the user to correct such interference.

The manufacturer is not responsible for any damage incurred in the operation of this system if the correct operational voltage setting was not selected prior to operation. **PLEASE VERIFY THAT THE VOLTAGE SETTING IS CORRECT BEFORE USE.**

## Package Contents

---

The CS1708A / CS1716A package consists of:

- ◆ 1 CS1708A / CS1716A KVM Switch with Standard Rack Mounting Kit
- ◆ 2 Custom KVM Cable Sets
- ◆ 1 Console Cable
- ◆ 1 Firmware Upgrade Cable
- ◆ 1 Grounding Wire
- ◆ 1 Foot Pad Set (4 pcs)
- ◆ 1 Power Adapter
- ◆ 1 User Manual\*
- ◆ 1 Quick Start Guide

Check to make sure that all the components are present and that nothing got damaged in shipping. If you encounter a problem, contact your dealer.

Read this manual thoroughly and follow the installation and operation procedures carefully to prevent any damage to the unit, and/or any of the devices connected to it.

---

\* Features may have been added to the CS1708A / CS1716A since this manual was printed. Please visit our website to download the most up-to-date version of the manual.

---

© Copyright 2008–2011 ATEN® International Co., Ltd.  
Manual Part No. PAPE-0293-100G  
Manual Date: 2011-09-21

ATEN and the ATEN logo are registered trademarks of ATEN International Co., Ltd. All rights reserved.  
All other brand names and trademarks are the registered property of their respective owners.

# Contents

---

FCC Information . . . . .	ii
RoHS. . . . .	ii
SJ/T 11364-2006. . . . .	ii
User Information . . . . .	iii
Online Registration . . . . .	iii
Telephone Support . . . . .	iii
User Notice . . . . .	iii
Package Contents. . . . .	iv
About this Manual . . . . .	viii
Conventions . . . . .	ix
Product Information. . . . .	ix

## 1. Introduction

Overview . . . . .	1
Features . . . . .	2
Requirements . . . . .	3
Console . . . . .	3
Computers. . . . .	3
Cables . . . . .	3
Operating Systems . . . . .	4
Components . . . . .	4
Front View . . . . .	4
Rear View . . . . .	6

## 2. Hardware Setup

Overview . . . . .	7
Before You Begin . . . . .	7
Stacking and Rack Mounting . . . . .	8
Stacking. . . . .	8
Rack Mounting – Front . . . . .	9
Rack Mounting – Rear. . . . .	11
Grounding . . . . .	13
Single Level Installation . . . . .	14
Cable Connection Diagrams . . . . .	15
Daisy Chain Installations. . . . .	16

### 3. Basic Operation

Hot Plugging . . . . .	19
Changing Station Positions . . . . .	19
Hot Plugging KVM Ports . . . . .	19
Hot Plugging Console Ports . . . . .	19
Port Selection . . . . .	20
Manual Port Switching . . . . .	20
Port ID Numbering . . . . .	20
Powering Off and Restarting . . . . .	21
USB Peripheral Devices . . . . .	21

### 4. OSD Operation

OSD Overview . . . . .	23
OSD Login . . . . .	23
OSD Hotkey . . . . .	23
OSD Main Screen . . . . .	24
OSD Main Screen Headings . . . . .	25
OSD Navigation . . . . .	25
OSD Functions . . . . .	26
F1: GOTO . . . . .	26
F2: LIST . . . . .	27
F3: SET . . . . .	28
F4: ADM . . . . .	30
F5: SKP . . . . .	33
F6: BRC . . . . .	34
F7: SCAN . . . . .	35
F8: LOUT . . . . .	36

### 5. Keyboard Port Operation

Hotkey Port Control . . . . .	37
Invoke Hotkey Mode . . . . .	38
Number Lock and Minus Keys . . . . .	38
Control and F12 Keys . . . . .	38
Select the Active Port . . . . .	39
Auto Scan Mode . . . . .	40
Invoking Auto Scan: . . . . .	40
Skip Mode . . . . .	41
Computer Keyboard / Mouse Reset . . . . .	42
Hotkey Beeper Control . . . . .	42
Quick Hotkey Control . . . . .	43
OSD Hotkey Control . . . . .	43
Port OS Control . . . . .	44
Restore Default Values . . . . .	44
Hotkey Summary Table . . . . .	45

## 6. Keyboard Emulation

Mac Keyboard . . . . .	47
Sun Keyboard . . . . .	48

## 7. The Firmware Upgrade Utility

Introduction . . . . .	49
Downloading the Firmware Upgrade Package . . . . .	49
Preparation . . . . .	50
Starting the Upgrade . . . . .	51
Upgrade Succeeded . . . . .	53
Upgrade Failed . . . . .	53
Firmware Upgrade Recovery . . . . .	54

## Appendix

Safety Instructions . . . . .	55
General . . . . .	55
Rack Mounting . . . . .	57
Technical Support . . . . .	58
International . . . . .	58
North America . . . . .	58
Specifications . . . . .	59
Connection Tables . . . . .	60
CS1708A . . . . .	60
CS1716A . . . . .	60
Supported KVM Switches . . . . .	61
Restoring Factory Default Settings . . . . .	62
OSD Factory Default Settings . . . . .	63
About SPHD Connectors . . . . .	63
Troubleshooting . . . . .	64
Overview . . . . .	64
Limited Warranty . . . . .	64

## About this Manual

---

This user manual is provided to help you get the most from your CS1708A / CS1716A system. It covers all aspects of installation, configuration and operation. An overview of the information found in the manual is provided below.

**Chapter 1, Introduction**, introduces you to the CS1708A / CS1716A system. Its purpose, features and benefits are presented, and its front and back panel components are described.

**Chapter 2, Hardware Setup**, describes how to set up your installation. The necessary steps – from a basic single stage hookup to a complete 32-switch daisy chained operation are provided.

**Chapter 3, Basic Operation**, explains the fundamental concepts involved in operating the CS1708A / CS1716A.

**Chapter 4, OSD Operation**, provides a complete description of the CS1708A / CS1716A's on-screen display (OSD), and how to work with it.

**Chapter 5, Keyboard Port Operation**, details all of the concepts and procedures involved in the hotkey operation of your CS1708A / CS1716A installation.

**Chapter 6, Keyboard Emulation**, provides tables that list the PC to Mac and PC to Sun keyboard emulation mappings.

**Chapter 7, The Firmware Upgrade Utility**, explains how to use this utility to upgrade the CS1708A / CS1716A's firmware with the latest available versions.

**An Appendix**, provides specifications and other technical information regarding the CS1708A / CS1716A.



## Conventions

---

This manual uses the following conventions:

- Monospaced      Indicates text that you should key in.
- [ ]                Indicates keys you should press. For example, [Enter] means to press the **Enter** key. If keys need to be chorded, they appear together in the same bracket with a plus sign between them: [Ctrl+Alt].
1.                 Numbered lists represent procedures with sequential steps.
- ◆                 Bullet lists provide information, but do not involve sequential steps.
- Indicates selecting the option (on a menu or dialog box, for example), that comes next. For example, Start → Run means to open the *Start* menu, and then select *Run*.
-                 Indicates critical information.

## Product Information

---

For information about all ATEN products and how they can help you connect without limits, visit ATEN on the Web or contact an ATEN Authorized Reseller. Visit ATEN on the Web for a list of locations and telephone numbers:

International	<a href="http://www.aten.com">http://www.aten.com</a>
North America	<a href="http://www.aten-usa.com">http://www.aten-usa.com</a>

This Page Intentionally Left Blank

# Chapter 1

## Introduction

### Overview

---

The CS1708A and CS1716A KVM switches are control units that allow access to multiple computers from a single console (keyboard, mouse, and monitor).

A single CS1708A or CS1716A can control up to 8 or 16 computers. As many as 31 additional switches can be daisy chained to each other, so that up to 256 or 512 computers can all be controlled from a single keyboard-monitor-mouse console.

A custom ASIC (patent pending) provides an auto-sensing function that recognizes the position of each station on the chain, eliminating the need to manually set the position with DIP switches. A seven segment front panel LED displays each station's position for easy identification.

For further convenience, the CS1708A / CS1716A features high density SPHD connectors instead of the usual 25-pin connectors. This space-saving innovation allows a full, 16-port switch, to be installed in a 1U system rack. Additionally, a front panel USB port is available for each computer to access any peripherals connected to it on a one-at-a-time basis.

Setup is fast and easy; plugging cables into their appropriate ports is all that is entailed. The CS1708A / CS1716A supports both USB and PS/2 connections for the console and computers; and because the CS1708A / CS1716A intercepts keyboard input directly, there is no software to configure, so there is no need to get involved in complex installation routines or be concerned with incompatibility problems.

Access to any computer connected to the installation is easily accomplished either by manually pressing the front panel pushbutton port LEDs, entering hotkey combinations from the keyboard, or by means of a powerful menu driven multilingual on-screen display (OSD) system. A convenient auto-scan feature also permits automatic scanning and monitoring of the activities of all computers running on the installation on a one at a time basis.

By allowing a single console to manage all the attached computers, a CS1708A / CS1716A installation: eliminates the expense of having to purchase a separate keyboard, monitor, and mouse for each computer; saves all the space those extra components would take up; saves on energy costs; and eliminates the inconvenience and wasted effort involved in constantly moving from one computer to another.

## Features

---

- ◆ A single console controls up to 8 (CS1708A) or 16 (CS1716A) computers
- ◆ Daisy chain up to 31 additional units – control up to 256 (CS1708A) or 512 (CS1716A) computers from a single console
- ◆ Front panel USB port allows each computer to access USB peripherals\*
- ◆ Dual Interface – supports computers with PS/2 or USB keyboards and mice
- ◆ Multiplatform support – Windows 2000/XP/Vista, Linux, Mac, and Sun
- ◆ Supports USB keyboards for PC, Mac and Sun
- ◆ Auto PS/2 and USB interface detection
- ◆ USB / PS/2 keyboard and mouse emulation – computers boot even when the console focus is elsewhere
- ◆ Superior video quality – up to 2048 x 1536; DDC2B
- ◆ Display Emulation Technology – stores the console monitor's EDID (Extended Display Identification Data) to optimize display resolution
- ◆ No software required – convenient computer selection via front panel pushbuttons, hotkeys and multilingual on-screen display (OSD) menus
- ◆ Auto-senses station's position on daisy chained installations; no need for manual dip switch setting; front panel led indicates station's position
- ◆ Port names automatically reconfigured when station sequence is changed
- ◆ Two level password security; only authorized users view and control computers; up to four users and an administrator with separate profiles for each
- ◆ Auto Scan feature for monitoring user-selected computers
- ◆ Broadcast mode; operations simultaneously performed on all selected computers
- ◆ Hot pluggable – add or remove computers without having to power down the switch
- ◆ Buzzer on/off via hotkey and OSD
- ◆ Firmware upgrades to all the chained KVM switches at the same time via the daisy chain cable
- ◆ Rack mountable in 19" system rack (1U)

---

\* The USB peripheral function only works with USB cable set connections. It will not work with PS/2 cable set connections.

---

## Requirements

---

### Console

The following hardware components are required for the KVM console:

- ◆ A VGA, SVGA, or multisync monitor capable of displaying the highest resolution provided by any computer in the installation.
- ◆ A keyboard and mouse (USB or PS/2)

### Computers

The following hardware components are required for each computer:

- ◆ A VGA, SVGA, or multisync video graphics card with an HDB-15 port.
- ◆ PS/2 mouse and keyboard ports (6-pin mini-DIN), at least one USB port.
- ◆ Direct support Sun USB systems; or, for Sun legacy systems, an ATEN CV130A Sun Console Converter.

### Cables

Substandard cables might damage the connected devices or degrade overall performance. For optimum signal integrity and to simplify the layout use the high quality custom cable sets described below.

Function		Length	Part Number
KVM switch to KVM switch (daisy chaining)		0.6 m	2L-1700
		1.8 m	2L-1701
KVM switch to computer	PS/2	1.2 m	2L-5201P
		1.8 m	2L-5202P
		3.0 m	2L-5203P
		6.0 m	2L-5206P
		1.8 m	2L-5702P
		USB	1.2 m
	1.8 m		2L-5202U
	3.0 m		2L-5203U
	5.0 m		2L-5205U

## Operating Systems

Supported operating systems are shown in the table, below:

OS		Version
Windows		2000 and higher
Linux	RedHat	7.1 and higher
	SuSE	8.2 and higher
	Mandriva (Mandrake)	9.0 and higher
UNIX	AIX	4.3 and higher
	FreeBSD	4.2 and higher
	Sun	Solaris 8 and higher
Novell	Netware	5.0 and higher
Mac		OS 9 and higher

## Components

### Front View

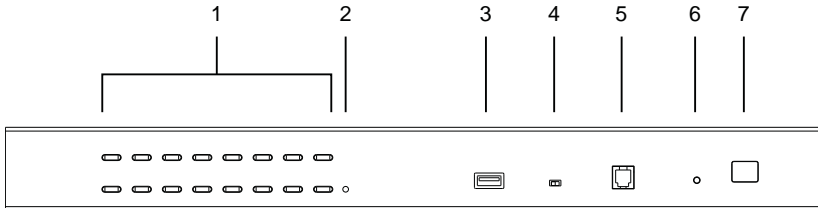

**Note:** The CS1716A is pictured above. The CS1708A front panel is the same as the CS1716A, except that it has 8 KVM port LEDs instead of 16.

No.	Component	Description
1	Port LEDs	<p>These port selection pushbuttons each contain 2 LEDs.</p> <ul style="list-style-type: none"> <li>◆ An orange LED indicates that a computer is connected to the corresponding port.</li> <li>◆ A green LED indicates that the computer connected to the corresponding port has focus.</li> <li>◆ Simultaneously pressing port LEDs 1 &amp; 2 resets the console keyboard and mouse.</li> <li>◆ Simultaneously pressing port LEDs 7 &amp; 8 on the CS1708A, or 15 &amp; 16 on the CS1716A, starts <i>Auto Scan</i> mode. See <i>F7: SCAN</i>, page 35</li> </ul>
2	Reset Button	<p>Pressing in this button performs a system reset. When the system is reset, the CS1708A / CS1716A beeps, and then the KVM port LEDs flash in succession until the reset is completed. After the reset is completed you can login again.</p> <p><b>Note:</b> This button is semi-rec essed and must be pushed with a small object, such as the end of a paper clip or a ballpoint pen.</p>
3	USB Port	<p>USB peripherals (flash drive, CD-ROM, etc.) plug into this port.</p>
4	Firmware Upgrade Recovery Switch	<p>During normal operation and while performing a firmware upgrade, this switch should be in the NORMAL position. If a firmware upgrade operation does not complete successfully, this switch is used to perform a firmware upgrade recovery. See <i>Firmware Upgrade Recovery</i>, page 54, for details.</p>
5	Firmware Upgrade Port	<p>The firmware upgrade cable that transfers the firmware upgrade data from the administrator's computer to the CS1708A / CS1716A, plugs into this RJ-11 connector.</p>
6	Power LED	<p>Lights to indicate that the unit is receiving power.</p>
7	Station ID LED	<p>The CS1708A / CS1716A station ID is displayed here. If this is a single station installation (see page 13), or the first station on a daisy chained installation (see page 15), the switch has a station ID of <b>01</b>.</p> <p>On a daisy chained installation, the CS1708A / CS1716A auto-senses its position and displays the station ID that corresponds to its place in the chain. (see <i>Port ID Numbering</i>, page 20 for details).</p>

## Rear View

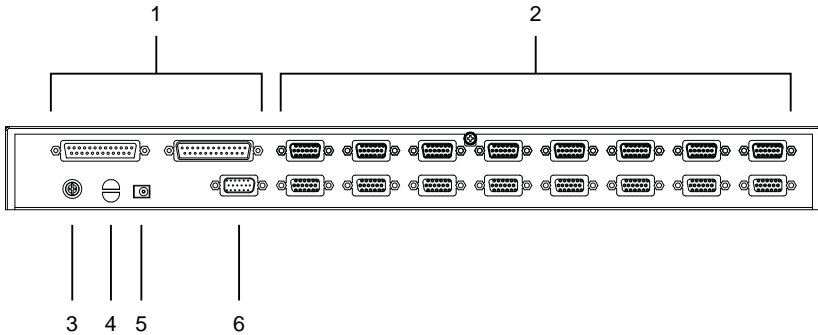

No.	Component	Description
1	Daisy Chain Ports	When daisy chaining units, the cables plug in here. The port on the right is the <i>Chain Out</i> port; the one on the left is the <i>Chain In</i> port.
2	KVM Ports	The cables that link to the computers plug in here. <b>Note:</b> The shape of these 15-pin connectors has been specifically modified so that only custom KVM cables designed to work with this switch can plug in. (See <i>Cables</i> , page 3, for details.) Do <b>NOT</b> attempt to use ordinary 15-pin VGA connector cables to link these ports to the computers.
3	Grounding Terminal	The grounding wire used to ground the CS1708A / CS1716A attaches here.
4	Cable Tie Slot	If you want to use a cable tie to gather the cables together, you can run it through this slot to attach it to the unit.
5	Power Jack	The power adapter cable plugs in here.
6	Console Port	The custom console cable set that is provided to attach the console monitor, keyboard, and mouse plugs in here.

**Note:** The CS1716A is pictured above. The CS1708A rear panel is the same as the CS1716A, except that it has 8 KVM ports instead of 16.



# Chapter 2

## Hardware Setup

### Overview

---

For convenience and flexibility that allows mixing PS/2 and USB interfaces, the CS1708A / CS1716A design utilizes custom KVM cables that serve as intermediaries between the KVM switch and the connected computers.

A separate custom KVM cable is required for each computer connection. The custom KVM cables are listed in the *Cables* section on page 3. Consult your dealer to find out which custom KVM cables best fit your needs.

### Before You Begin

---



1. Important safety information regarding the placement of this device is provided on page 55. Please review it before proceeding.
2. Make sure that the power to any device that you connect to the installation has been turned off. You must unplug the power cords of any computers that have the Keyboard Power On function.

## Stacking and Rack Mounting

---

The CS1708A / CS1716A can be stacked on a desktop or rack mounted by a variety of different methods in 1U of rack space. The procedures for each method are described in the following sections.

- 
- Note:**
1. Allow at least 5.1 cm on each side for adequate ventilation and 12.7 cm at the rear for power cord and cable clearance.
  2. The standard rack mounting kit does not include screws or cage nuts. If you need additional screws or cage nuts, contact your rack dealer.
  3. For instructional purposes, the CS1708A is pictured in the diagrams that follow. However, the CS1708A is the same as the CS1716A, except that it has 8 KVM ports instead of 16.
- 

### Stacking

The CS1708A / CS1716A can be placed on any level surface that can safely support its weight and the weight of the attached cables. Ensure that the surface is clean and free of materials that can block the exhaust vents or otherwise interfere with normal operation of the KVM switch. Peel the protective backing off of the foot pads, and affix them to the bottom panel of the CS1708A / CS1716A at the corners, as shown in the diagram below.

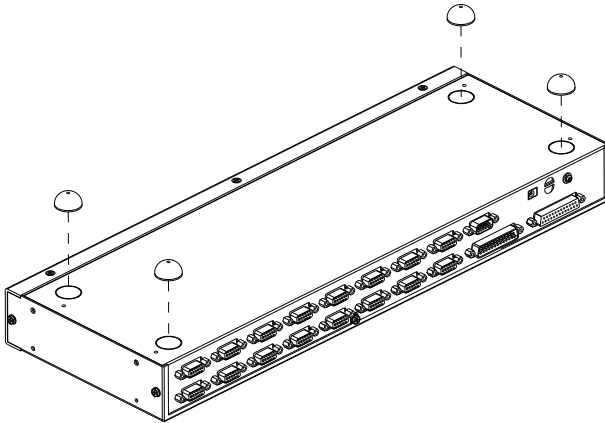

## **Rack Mounting – Front**

1. Remove the screws from the left and right sides of the switch (2 screws total) near the front of the switch.

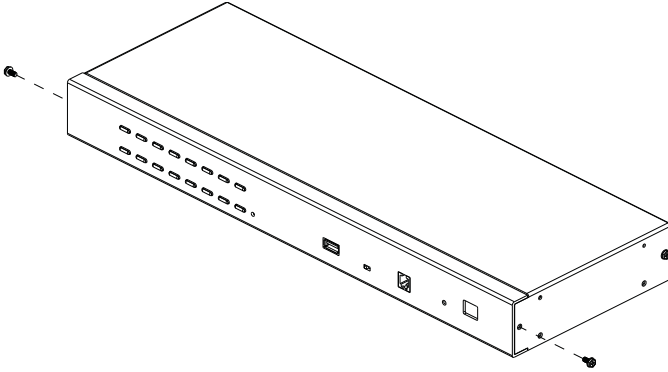

2. Use the M3 x 8 Phillips hex head screws supplied with the rack mounting kit to screw the rack mounting brackets into the sides near the front of the unit.

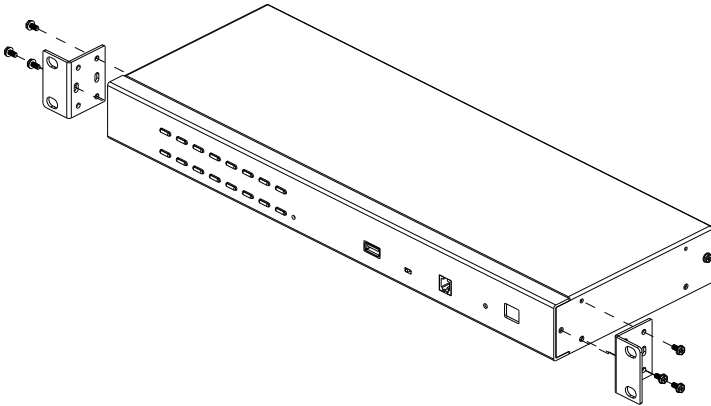

*(Continues on next page.)*

*(Continued from previous page.)*

3. Place the KVM switch in the rack. Position it so that the holes in the mounting brackets line up with the holes in the rack. Secure the mounting brackets to the front of the rack.

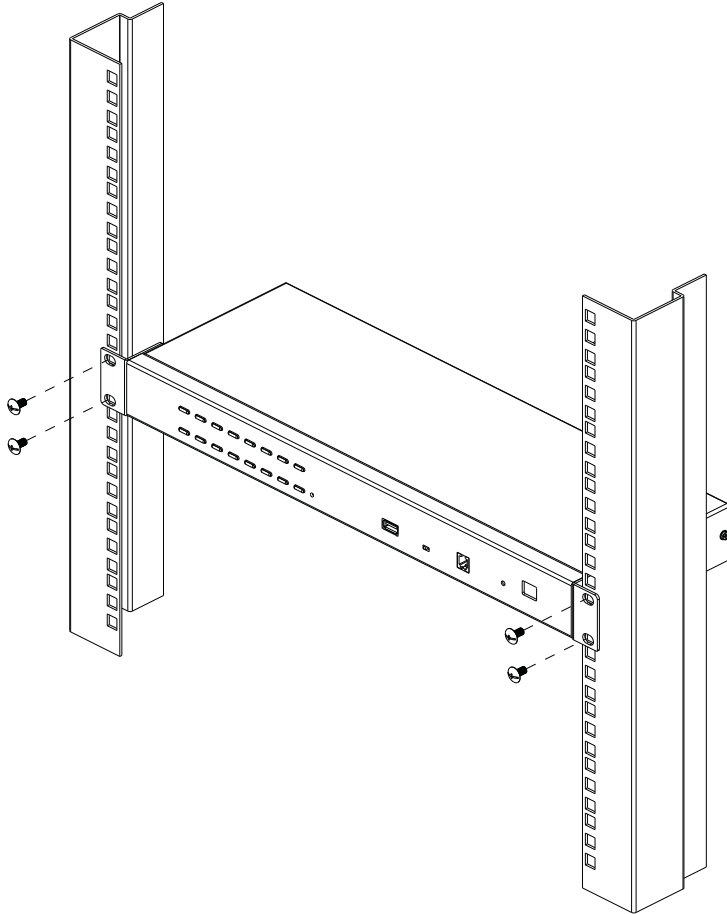

## **Rack Mounting – Rear**

1. Remove 1 screw each from the left and right sides of the switch (2 screws total) near the rear of the unit.

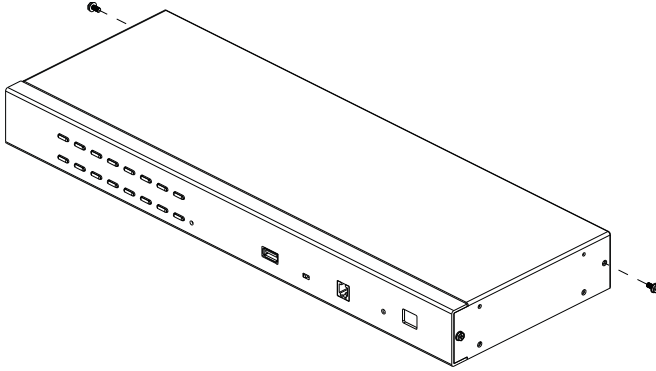

2. Use the M3 x 8 Phillips hex head screws supplied with the rack mounting kit to screw the rack mounting brackets into the sides near the rear of the unit.

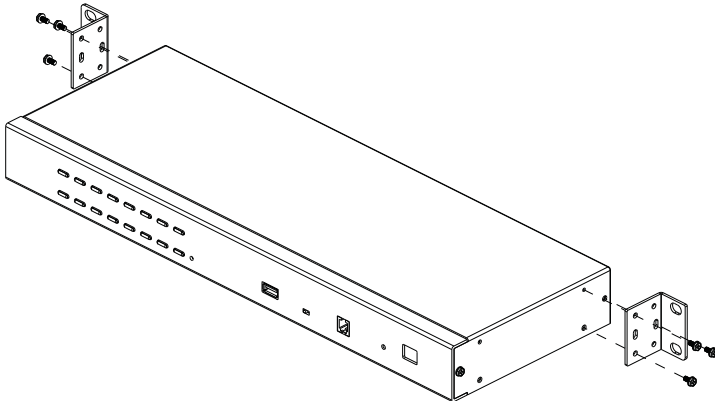

*(Continues on next page.)*

*(Continued from previous page.)*

3. Place the KVM switch in the rack. Position it so that the holes in the mounting brackets line up with the holes in the rack. Secure the mounting brackets to the rear of the rack.

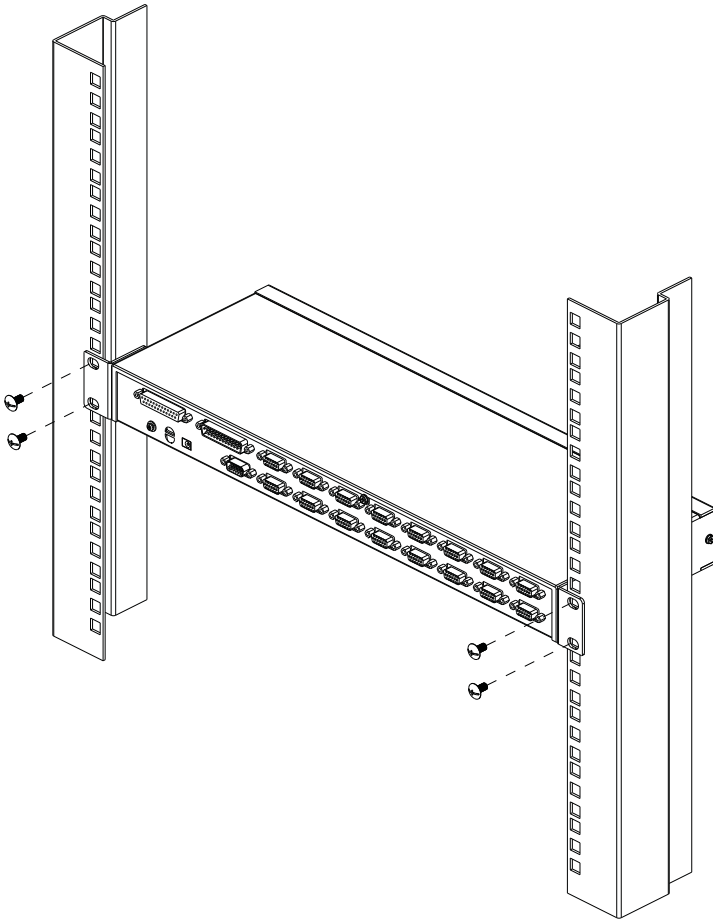

## Grounding

---

To prevent damage to your installation it is important that all devices are properly grounded.

Use a grounding wire to ground the CS1708A / CS1716A by connecting one end of the wire to the grounding terminal, and the other end of the wire to a suitable grounded object.

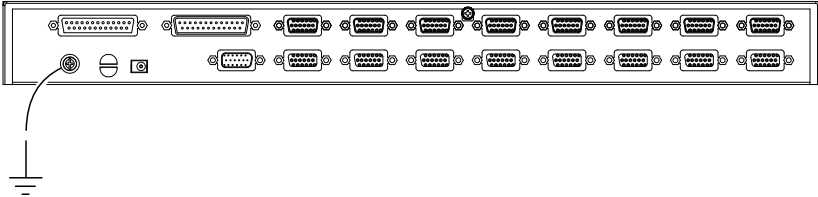

## Single Level Installation

In a single level installation, there are no additional switches daisy chained down from the first unit. To set up a single level installation do the following:

1. Ground the CS1708A / CS1716A and make sure that power has been turned off to all the computers you will be connecting up.
2. Using the console cable provided, connect a keyboard, mouse, and monitor to the CS1708A / CS1716A console port. Refer to the *Cable Connection Diagrams* on the following page.
3. Use KVM cable sets (as described in the *Cables* section on page 3), to connect any available KVM port to the keyboard, video and mouse ports of the computer you are installing. Refer to the *KVM Cable Installation Diagrams* on the following page.
4. Plug the power adapter cable into the CS1708A / CS1716A power jack, then plug the power adapter into an AC power source.
5. Turn on the power to the computers.

### Single Level Installation Diagram

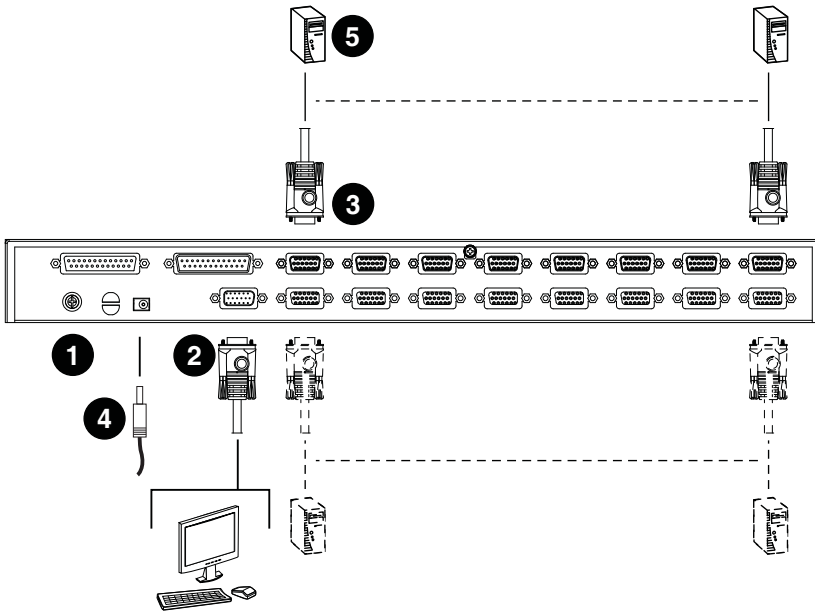

**Note:** The numbers in the diagram correspond to the numbered steps above.



# Cable Connection Diagrams

## Console Cable Installation Diagram

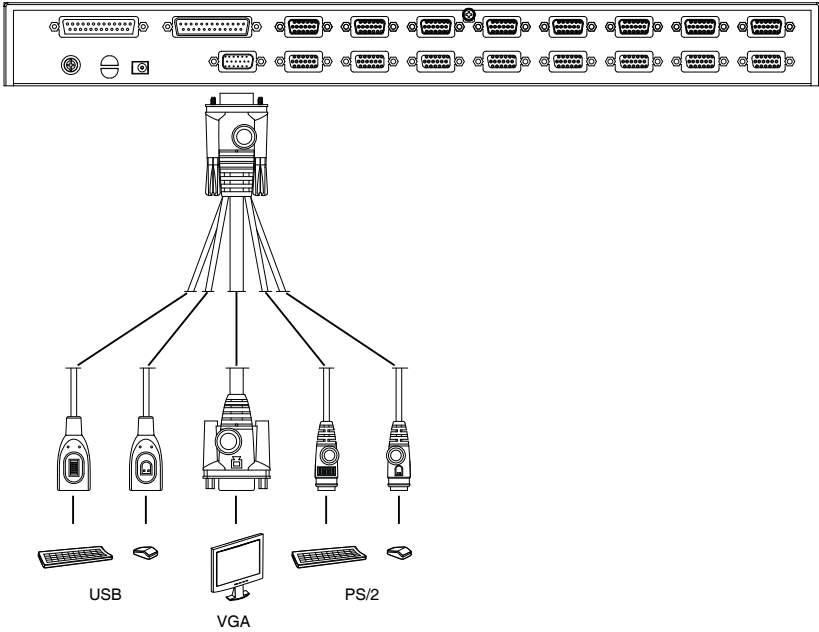

## KVM Cable Installation Diagrams

### USB KVM Cable Connection

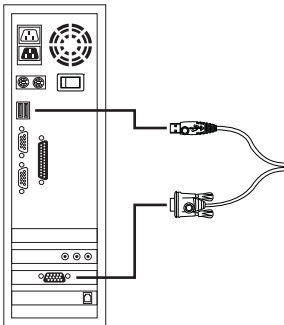

### PS/2 KVM Cable Connection

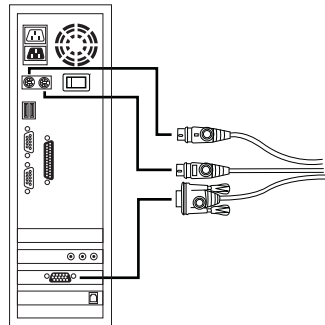

## Daisy Chain Installations

---

To control even more computers, up to 31 additional switches can be daisy chained down from the first CS1708A / CS1716A. As many as 512 computers can be controlled from a single console in a complete installation. Tables showing the relation between the number of computers and the number of CS1708A / CS1716A units needed to control them are provided on page 60 in the Appendix.

To set up a daisy chained installation, do the following:

1. Ground the CS1708A / CS1716A and make sure that power has been turned off to all the computers you will be connecting up.
2. Using the console cable provided, connect a keyboard, mouse, and monitor to the CS1708A / CS1716A console port. Refer to the *Cable Connection Diagrams* on the following page.
3. Use a daisy chain cable set (described in the *Cables* section, page 3), to connect the *Chain Out* port of the master CS1708A / CS1716A unit to the *Chain In* port of the slave unit (first station out to second station in, second station out to third station in, etc.).<sup>1</sup>

---

**Note:** You cannot use the *Chain In* port of the first station CS1708A / CS1716A, since it is the highest level master.

---

4. Use KVM cable sets (described in the *Cables* section, page 3), to connect any available KVM port on the CS1708A / CS1716A installation to the keyboard, video and mouse ports of the computers you are installing.
5. Repeat the above steps for any additional units you wish to add to the chain.
6. Power up the installation according to the following procedure:
  - a) Plug in the power adapter for the first station.  
Wait for the unit's station ID to display on the station ID LED.  
The station ID for the first stage unit is **01**, the ID for the second stage unit is **02**, etc.
  - b) Plug in the power adapters for each station on the installation in turn (second station, then third station, etc.).  
In each case, wait for the station ID to be ascertained and displayed on the current station before plugging in the next one.
  - c) After all the stations are up, power on the computers.

---

1. See p. 61 for a list of supported KVM switches.

## Daisy Chained Installation Diagram

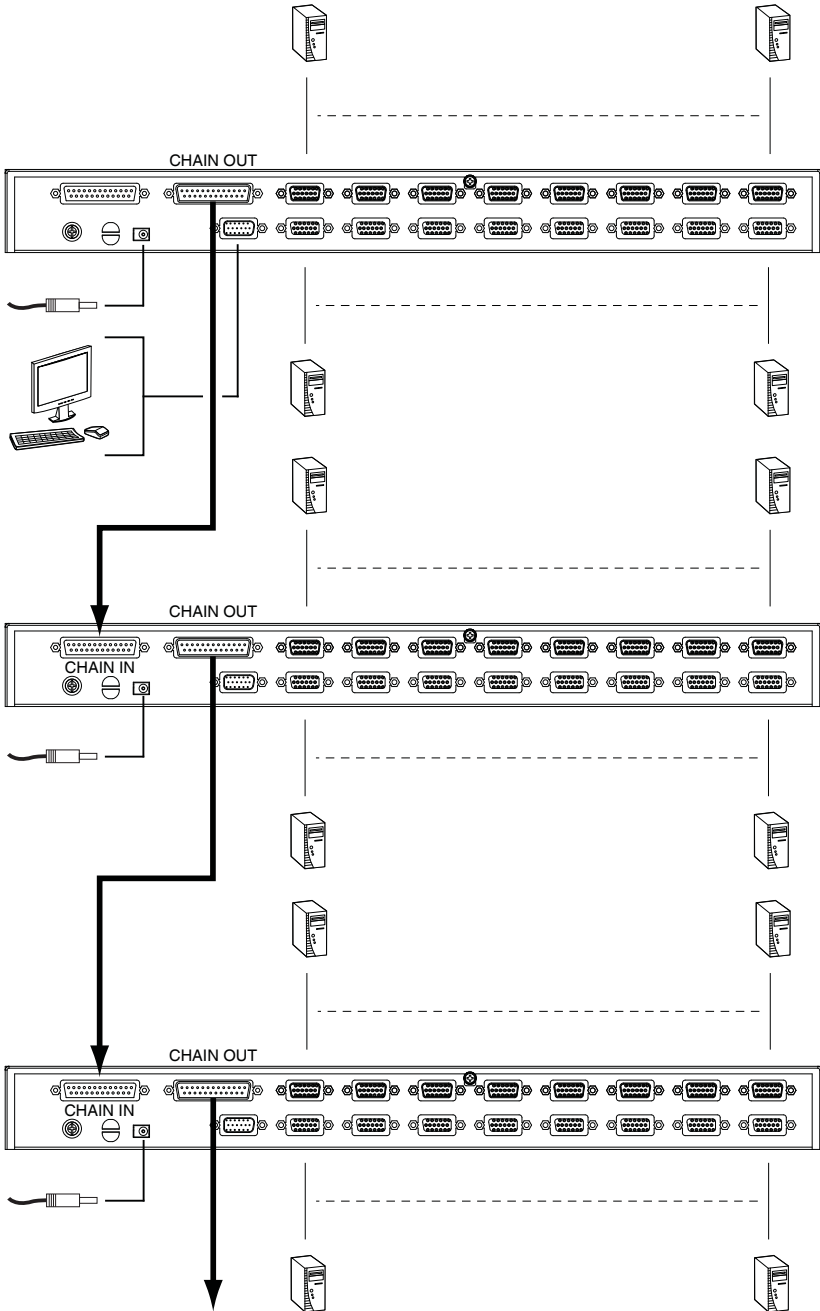

This Page Intentionally Left Blank

# Chapter 3

## Basic Operation

### Hot Plugging

---

The CS1708A / CS1716A supports *hot plugging* – components can be removed and added back into the installation by unplugging their cables from the ports without the need to shut the unit down. In order for hot plugging to work properly, however, the procedures described below must be followed:

### Changing Station Positions

You can change a station's position by simply disconnecting it from its master and reconnecting it to another switch in the chain. In order for the OSD menus to correspond to the change, the station IDs must be reset in the OSD. See *RESET STATION IDS*, page 32 for details.

### Hot Plugging KVM Ports

In order for the OSD menus to correspond to KVM port changes, you must manually reconfigure the OSD to reflect the new port information. See the *F3 SET* (page 28) and *F4 ADM* (page 30), functions for details.

---

**Note:** If the computer's operating system does not support hot plugging, this function may not work properly.

---

### Hot Plugging Console Ports

The keyboard, monitor, and mouse can all be hot plugged. When hot plugging the mouse:

- ◆ You may unplug and replug the mouse (to reset the mouse, for example), as long as you use the same mouse.
- ◆ If you plug in a different mouse, all the stations and all the computers on the installation must be shut down for 10 seconds, then restarted following the power up sequence described under Step 5 on page 16.

---

**Note:** If, after hot plugging there is no response to keyboard and/or mouse input, perform a *Keyboard and Mouse Reset* by simultaneously pressing the 1 and 2 front panel port LEDs.

---

## Port Selection

---

The CS1708A / CS1716A provides three port selection methods to access the computers on the installation: Manual, an OSD (on-screen display) menu system, and Hotkeys. See Chapter 4, *OSD Operation* and Chapter 5, *Keyboard Port Operation* for more information.

### **Manual Port Switching**

Use the front panel pushbutton switches to manually switch to a port.

## Port ID Numbering

---

Each KVM port on a CS1708A / CS1716A installation is assigned a unique port ID. The port ID is made up of two parts: a *Station Number*, and a *Port Number*:

- ♦ The *Station Number* is a two digit number of the switch's position in the daisy chain sequence. This number is displayed on the front panel station ID LED.
- ♦ The *Port Number* is a two digit number of the port on the CS1708A / CS1716A station that a computer is connected to.
- ♦ The station number precedes the port number.
- ♦ Station and port numbers from 1–9 are padded with a preceding zero, so they become 01–09.

For example, a computer attached to **Port 6** of **Station 12** would have a port ID of: **12-06**.

## Powering Off and Restarting

---

If it becomes necessary to power off a CS1708A / CS1716A, do the following before restarting it:

1. Shut down all the computers that are attached to the CS1708A / CS1716A.

---

**Note:** Unplug the power cords of any computers that have the *Keyboard Power On* function. Otherwise, the CS1708A / CS1716A will still receive power from the computers.

---

2. Unplug the CS1708A / CS1716A from its power source.
3. Wait 10 seconds, then plug the CS1708A / CS1716A back in.
4. After the CS1708A / CS1716A has started and ascertained its station ID, power on the computers.

---

**Note:** If you have shut down more than one station, power up the highest station first and work your way down to the lowest one.

---

## USB Peripheral Devices

---

The front panel USB port is available to connect a USB peripheral device (flash drive, CD-ROM drive, printer, etc.) to the CS1708A / CS1716A. Any computer connected to the CS1708A / CS1716A can access the USB peripheral on a one-at-a-time basis. The peripheral device is available to computers connected to the CS1708A / CS1716A on the same level only, and is not available to computers connected to daisy chained switches.

The USB peripheral device is automatically detected on target computers when switching ports on the CS1708A / CS1716A. For example, when switching from a computer connected to port 1 to a computer connected to port 2, the peripheral device automatically disconnects from the computer on port 1 and connects to the computer on port 2.

This Page Intentionally Left Blank



# Chapter 4

## OSD Operation

### OSD Overview

---

The on-screen display (OSD) is a mouse and keyboard enabled, menu driven method to handle computer control and switching operations. All procedures start from the OSD main screen.

### OSD Login

The OSD incorporates a two level (administrator / user) password system. Before the OSD main screen displays, a login screen appears requiring a password. If this is the first time that the OSD is used, or if the password function has not been set, simply press **[Enter]**. The OSD main screen displays in administrator mode. In this mode, you have administrator privileges, with access to all administrator and user functions, and can set up operations (including password authorization) as you like. If the password function has been set, you must provide an appropriate administrator/user password in order to access the OSD.

### OSD Hotkey

You can display the OSD on the console monitor while also viewing the display of any port on the CS1708A / CS1716A by pressing the **[Scroll Lock]** key twice.

---

**Note:** You can optionally change the OSD hotkey to the Ctrl key, in which case you would press **[Ctrl]** twice (see *OSD Hotkey*, page 28). With this method, you must press the same **[Ctrl]** key.

---

## **OSD Main Screen**

When you invoke the OSD, a screen similar to the one below appears:

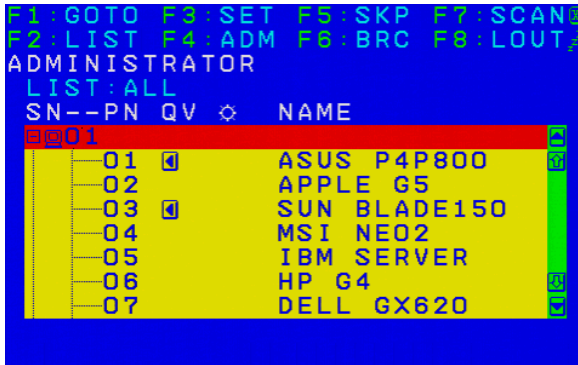

- 
- Note:**
1. The diagram depicts the administrator's main screen. The user main screen does not show the **F4** and **F6** functions, since these are reserved for the administrator and can't be accessed by users.
  2. The OSD always starts in list view, with the highlight bar at the same position it was in the last time it was closed.
  3. Only the ports that have been set accessible by the administrator for the current logged in user are visible (see *SET ACCESSIBLE PORTS*, page 30, for details).
  4. If the port list is collapsed, click on a switch number, or move the highlight bar to it then press the right arrow key to expand the list. Similarly, to collapse a switch's port list, click on the switch number, or move the highlight bar to it then press the left arrow key to collapse the list.
-

## OSD Main Screen Headings

SN--PN	This column lists the port ID numbers (station number - port number) for all the KVM ports on the installation. The simplest method to access a particular computer is move the highlight bar to it, then press <b>Enter</b> .
QV	If a port has selected for quick view scanning (see <i>Set Quick View Ports</i> , page 32), an arrowhead displays in this column to indicate so.
	The computers that are powered on and are online have a sun symbol in this column to indicate so.
NAME	If a port has been given a name (see <i>Edit Port Names</i> , page 31), its name appears in this column.

## OSD Navigation

- ◆ To dismiss the menu, and deactivate OSD, click the **X** at the upper right corner of the OSD window; or press **[Esc]**.
- ◆ To log out, click **F8** at the top of the main screen, or press **[F8]**.
- ◆ To move up or down through the list one line at a time, click the up and down triangle symbols (**▲▼**) or use the up and down arrow keys. If there are more list entries than what can appear on the main screen, the screen will scroll.
- ◆ To move up or down through the list one screen at a time, click the up and down arrow symbols (**↑↓**), or use the **[Pg Up]** and **[Pg Dn]** keys. If there are more list entries than what can appear on the main screen, the screen will scroll.
- ◆ To activate a port, double-click it, or move the highlight bar to it then press **[Enter]**.
- ◆ After executing any action, you automatically go back to the menu one level above.

## OSD Functions

---

OSD functions are used to configure and control the OSD. For example, you can rapidly switch to any port, scan selected ports, limit the list you wish to view, designate a port as a quick view port, create or edit a port name, or make OSD setting adjustments.

To access an OSD function:

1. Either click a function key field at the top of the main screen, or press a function key on the keyboard.
2. In the submenus that appear make your choice either by double-clicking it, or moving the highlight bar to it, then pressing **[Enter]**.
3. Press **[Esc]** to return to the previous menu level.

### **F1: GOTO**

Clicking the **F1** field or pressing **[F1]** activates the GOTO function. GOTO allows you to switch directly to a port either by keying in the port's *Name*, or its *Port ID*.

- ♦ To use the name method, key in **1**; key in the port's *Name*; then press **[Enter]**.
- ♦ To use the port ID method, key in **2**; key in the *Port ID*; then press **[Enter]**.

---

**Note:** You can key in a partial name or port ID. In that case, the screen will show all the computers that the user has *View* rights to (see *SET ACCESSIBLE PORTS*, page 30), that match the name or port ID pattern, regardless of the current list settings (see *F2 LIST*, page 27, for details).

---

To return to the OSD main screen without making a choice, press **[Esc]**.

## **F2: LIST**

This function lets you broaden or narrow the scope of which ports the OSD displays on the main screen. The submenu choices and their meanings are given in the table below.

<b>Choice</b>	<b>Meaning</b>
ALL	Lists all of the ports on the installation that have been set accessible by the administrator for the current logged in user.
QUICK VIEW	Lists only the ports that have been selected as quick view ports (see <i>SET QUICK VIEW PORTS</i> , page 32).
POWERED ON	Lists only the ports that have their attached computers powered on.
QUICK VIEW + POWERED ON	Lists only the ports that have been selected as quick view ports (see <i>SET QUICK VIEW PORTS</i> , page 32), and that have their attached computers powered on.

Move the highlight bar to the choice you want, then press **[Enter]**. An icon appears before the choice to indicate that it is the currently selected one.

### **F3: SET**

This function allows the administrator and each user to set up his own working environment. A separate profile for each is stored by the OSD and is activated according to the username that was provided during login.

To change a setting:

1. Double-click it; or move the highlight bar to it, then press **[Enter]**.
2. After you select an item, a submenu with further choices appears. To make a selection, either double-click it; or move the highlight bar to it, then press **[Enter]**. An icon appears before the selected choice to indicate which one it is. The settings are explained in the following table:

<b>Setting</b>	<b>Function</b>
OSD HOTKEY	Selects which hotkey activates the OSD function:  <b>[Scroll Lock] [Scroll Lock] or [Ctrl] [Ctrl]</b> .  Since the [Ctrl] key combination may conflict with programs running on the computers, the default is the [Scroll Lock] combination.
PORT ID DISPLAY POSITION	Allows each user to customize the position where the port ID appears on the screen. The default is the upper left corner, but users can choose to have it appear anywhere on the screen.  Use the mouse or the arrow keys plus Pg Up, Pg Dn, Home, End, and 5 (on the numeric keypad with Num Lock off), to position the port ID display, then double-click or press <b>[Enter]</b> to lock the position and return to the Set submenu.
PORT ID DISPLAY DURATION	Determines how long a port ID displays on the monitor after a port change has taken place. The choices are: <b>3 Seconds</b> (default) and <b>Always Off</b> .
PORT ID DISPLAY MODE	Selects how the port ID is displayed: the port number plus the port name ( <b>PORT NUMBER + PORT NAME</b> ) (default); the port number alone ( <b>PORT NUMBER</b> ); or the port name alone ( <b>PORT NAME</b> ).
SCAN DURATION	Determines how long the focus dwells on each port as it cycles through the selected ports in Auto Scan mode (see <i>F7 SCAN</i> , page 35). Key in a value from 1–255 seconds, then press <b>[Enter]</b> . Default is 5 seconds; a setting of 0 disables the SCAN function.

*(Continues on next page.)*

(Continued from previous page.)

Setting	Function
SCAN-SKIP MODE	<p>Selects which computers will be accessed under skip mode (see <i>F5 SKP</i>, page 33), and Auto Scan mode (see <i>F7 SCAN</i>, page 35). Choices are:</p> <p><b>ALL</b> - All the ports which have been set accessible (see <i>SET ACCESSIBLE PORTS</i>, page 30);</p> <p><b>QUICK VIEW</b> - Only those ports which have been set accessible and have been selected as quick view ports (see <i>SET QUICK VIEW PORTS</i>, page 32);</p> <p><b>POWERED ON</b> - Only those ports which have been set accessible and are powered on;</p> <p><b>QUICK VIEW + POWERED ON</b> - Only those ports which have been set accessible and have been selected as quick view ports and are powered on. The default is ALL.</p> <p><b>Note:</b> The quick view choices only show up on the administrator's screen, since only he has <i>Quick View</i> setting rights (see <i>SET QUICK VIEW PORTS</i>, page 32, for details).</p>
SCREEN BLANKER	<p>If there is no input from the console for the amount of time set with this function, the screen is blanked. Key in a value from 1–30 minutes, then press <b>[Enter]</b>. The default setting of 0 disables this function.</p>
HOTKEY COMMAND MODE	<p>Enables / disables the hotkey command function in case a conflict with programs running on the computers occurs.</p>
HOTKEY	<p>Sets the keyboard shortcut for invoking <i>Hotkey Mode</i> (see page 37). Choices are: <b>NUM LOCK + -</b> (minus) (default), and <b>CTRL + F12</b>.</p>
OSD LANGUAGE	<p>Sets the language used in the OSD. Choices are: English (default), German, Japanese, Simplified Chinese and Traditional Chinese.</p>

## **F4: ADM**

F4 is an administrator only function. It allows the administrator to configure and control the overall operation of the OSD. To change a setting double-click it, or use the up and down arrow keys to move the highlight bar to it then press **[Enter]**.

After you select an item, a submenu with further choices to select from appears. Double-click an item, or move the highlight bar to it then press **[Enter]**. An icon appears before the selected item so that you know which one it is. The settings are explained in the following table:

<b>Setting</b>	<b>Function</b>
SET USER LOGIN	<p>This function is used to set usernames and passwords for the administrator and users:</p> <ol style="list-style-type: none"> <li>1. Usernames and passwords for one administrator and four users can be set.</li> <li>2. After you select the administrator field or one of the user fields, a screen that allows you to key in the username and password appears. Usernames and passwords can be from 1 to 16 characters long and can consist of any combination of letters and numbers (A–Z, 0–9) and some additional keys (* ( ) + : - , ? . / space).</li> <li>3. For each individual, key in the username and password, confirm the password, then press <b>[Enter]</b>.</li> <li>4. To modify or delete a previous username and/or password, use the backspace key to erase individual letters or numbers. Press <b>[Enter]</b> when done.</li> </ol> <p><b>Note:</b> Usernames and passwords are not case sensitive. Usernames are displayed in capital letters in the OSD.</p>
SET ACCESSIBLE PORTS	<p>This function allows the administrator to define user access to the computers on the installation on a port-by-port basis.</p> <p>For each user, select the target port; then press the <b>[Spacebar]</b> to cycle through the choices: <b>F</b> (full access), <b>V</b> (view only), or blank. Repeat until all access rights have been set, then press <b>[Enter]</b>. The default is <b>F</b> for all users on all ports.</p> <p><b>Note:</b></p> <ul style="list-style-type: none"> <li>◆ A blank setting means that no access rights are granted. The port will not show up on the user's LIST on the main screen.</li> <li>◆ The administrator always has full access to all ports.</li> </ul>

*(Continues on next page.)*



(Continued from previous page.)

Setting	Function
SET LOGOUT TIMEOUT	<p>If there is no input from the console for the amount of time set with this function, the user is automatically logged out. A login is necessary before the console can be used again.</p> <p>This enables other users to gain access to the computers when the original user is no longer accessing them, but has forgotten to log out. To set the timeout value, key in a number from 1–180 minutes, then press <b>[Enter]</b>. The default setting of 0 disables this function.</p>
EDIT PORT NAMES	<p>To help remember which computer is attached to a particular port, every port can be given a name. This function allows the administrator to create, modify, or delete port names.</p> <p>To edit a port name:</p> <ol style="list-style-type: none"> <li>Click the port, or use the navigation keys to move the highlight bar to it, then press <b>[Enter]</b>.</li> <li>Key in the new port name, or modify/delete the old one. The maximum number of characters allowed for the port name is 12. Legal characters include: <ul style="list-style-type: none"> <li>◆ All alpha characters: <b>A–Z</b></li> <li>◆ All numeric characters: <b>0–9</b></li> <li>◆ <b>* ( ) + : - , ? . /</b> and <b>Space</b></li> </ul> </li> </ol> <p>Case does not matter; OSD displays the port name in all capitals no matter how they were keyed in.</p> <ol style="list-style-type: none"> <li>When you have finished editing, press <b>[Enter]</b> to have the change take effect. To abort the change, press <b>[Esc]</b>.</li> </ol>
RESTORE DEFAULT VALUES	<p>This function is used to undo all changes and return the setup to the original factory default settings (see <i>OSD FACTORY DEFAULT SETTINGS</i>, page 61) except for the port name list, username and password information, which are saved.</p>
CLEAR THE NAME LIST	<p>This function clears the port name list.</p>
ACTIVATE BEEPER	<p>Choices are <b>Y</b> (on), or <b>N</b> (off). When activated, the beeper sounds whenever a port is changed; when activating the Auto Scan function (see <i>F7 SCAN</i>, page 35); or an invalid entry is made on an OSD menu. The default is <b>Y</b>.</p>

(Continues on next page.)

(Continued from previous page.)

Setting	Function
SET QUICK VIEW PORTS	<p>This function lets the administrator select which ports to include as quick view ports.</p> <ul style="list-style-type: none"> <li>◆ To select/deselect a port as a quick view port, double-click the port, or use the navigation keys to move the highlight bar to it, then press <b>[Spacebar]</b>.</li> <li>◆ When a port has been selected as a quick view port, an icon displays in the QV column of the LIST on the main screen. When a port is deselected, the icon disappears.</li> <li>◆ If one of the quick view options is chosen for the LIST view (see <i>F2 LIST</i>, page 27), only a port that has been selected here will display on the list.</li> <li>◆ If one of the quick view options is chosen for auto-scanning (see <i>SCAN/SKIP MODE</i>, page 29), only a port that has been selected here will be auto-scanned.</li> </ul> <p>The default has no ports selected for quick view.</p>
RESET STATION IDS	<p>If you change the position of one of the stations in the daisy chain, the OSD settings will no longer correspond to the new location. This function directs the OSD to rescan the station positions of the entire installation and updates the OSD so that the OSD station information corresponds to the new physical layout.</p> <p><b>Note:</b> Only the station numbers get updated. Except for the port names, all administrator settings (such as SET ACCESSIBLE PORTS, SET QUICK VIEW PORTS, etc.) must be input again for all of the computers affected by the change.</p>
SET OPERATING SYSTEM	<p>This function allows the administrator to define the operating system for the computer connected to each KVM port. The default is WIN (PC compatible).</p> <p><b>To set the port operating system:</b></p> <ol style="list-style-type: none"> <li>1. From the list, select the port for which you wish to set the computer's operating system.</li> <li>2. Set the operating system by pressing <b>[Spacebar]</b> to cycle through WIN, MAC, SUN, or OTHER .</li> <li>3. Press <b>[Esc]</b> to exit. The operating system you selected is assigned to the KVM port.</li> </ol>

(Continues on next page.)

(Continued from previous page.)

Setting	Function
FIRMWARE UPGRADE	In order to upgrade the CS1708A / CS1716A firmware (see page 49), you must first enable Firmware Upgrade mode with this setting.  When you bring up this menu, the current firmware version levels are displayed. Select <b>Y</b> to enable Firmware Upgrade mode, or <b>N</b> to leave this menu without enabling it.
SET KEYBOARD LANGUAGE	Sets the language for the computer keyboard attached to the KVM port. To select a keyboard language, double-click it, or use the navigation keys to move the highlight bar to it, then press <b>[Enter]</b> .  Choices are: AUTO (default), ENGLISH (US), ENGLISH (UK), GERMAN (GER.), GERMAN (SWISS), FRENCH, HUNGARIAN, ITALIAN, JAPANESE, KOREAN, RUSSIAN, SPANISH, SWEDISH and TRADITIONAL CHINESE.

## **F5: SKP**

Clicking the **F5** field or pressing **[F5]** invokes Skip (SKP) mode. This function enables you to easily skip backward or forward – switching the console focus from the currently active computer port to the previous or next available one.

- ◆ The selection of computers to be available for skip mode switching is made with the *Scan–Skip* mode setting under the **F3: SET** function (see page 28).
- ◆ When you are in skip mode:
  - press [ ← ] to switch to the previous computer in the list
  - press [ → ] to switch to the next computer in the list
  - press [ ↑ ] to switch to the last computer on the previous station in the list
  - press [ ↓ ] to switch to the first computer on the next station in the list.

---

**Note:** When you skip, you only skip to the the previous or next available computer that is in the *Scan–Skip* mode selection (page 29).

---

- ◆ If a port has been selected for *Scan–Skip* mode, when the focus switches to that port a left/right triangle symbol appears before its port ID display.
- ◆ While skip mode is in effect, the console will not function normally. You must exit skip mode in order to regain control of the console.
- ◆ To exit skip mode, press **[Spacebar]** or **[Esc]**.

## **F6: BRC**

F6 is an administrator only function. Clicking the **F6** field, or pressing **[F6]**, invokes *Broadcast* (BRC) mode. When this function is in effect, commands sent from the console are broadcast to all available computers on the installation.

This function is particularly useful for operations that need to be performed on multiple computers, such as performing a system wide shutdown, installing or upgrading software, etc.

- ◆ While BRC mode is in effect, a speaker symbol appears before the port ID display of the port that currently has the console focus.
- ◆ While BRC mode is in effect, the mouse will not function normally. You must exit BRC mode in order to regain control of the mouse.
- ◆ To exit BRC mode, invoke the OSD (with the OSD hotkey), then click the **F6** field, or press **[F6]**, to turn BRC mode off.

## **F7: SCAN**

Clicking the **F7** field or pressing [**F7**] invokes *Auto Scan* mode. This function allows you to automatically switch among the available computers at regular intervals so that you can monitor their activity without having to take the trouble of switching yourself.

- ◆ The selection of computers to be included for auto-scanning is made with the *Scan-Skip* mode setting under the **F3: SET** function (see page 29).
- ◆ The amount of time that each port displays for is set with the *Scan Duration* setting under the **F3: SET** function (see page 28). When you want to stop at a particular location, press the [Spacebar] to stop scanning.
- ◆ If the scanning stops on an empty port, or one where the computer is attached but is powered Off, the monitor screen will be blank, and the mouse and keyboard will have no effect. After the *Scan Duration* time is up, the scan function will move on to the next port.
- ◆ As each computer is accessed, an **S** appears in front of the port ID display to indicate that it is being accessed under *Auto Scan* mode.
- ◆ While *Auto Scan* mode is in effect, the console will not function normally. You must exit *Auto Scan* mode in order to regain control of the console.
- ◆ While you are in *Auto Scan* mode, you can pause the scanning in order to keep the focus on a particular computer either by pressing **P**, or with a left-click of the mouse. See *Invoking Auto Scan*, page 40, for details.
- ◆ To exit *Auto Scan* mode, press the [**Spacebar**] or [**Esc**].

## **F8: LOUT**

Clicking the **F8** field, or pressing **[F8]** logs you out of OSD control of the computers, and blanks the console screen. This is different from simply pressing **[Esc]** when you are at the main screen to deactivate the OSD. With this function you must log in all over again to regain access to the OSD, whereas with **[Esc]**, all you have to do to reenter the OSD is tap the OSD hotkey.

- 
- Note:**
1. When you reenter the OSD after logging out, the screen stays blank except for the OSD main screen. You must input your username and password before you can continue.
  2. If you reenter the OSD after logging out, and immediately use **[Esc]** to deactivate the OSD without having selected a port from the OSD menu, a null port message displays on the screen. The OSD hotkey will bring up the main OSD screen.
-

# Chapter 5

## Keyboard Port Operation

### Hotkey Port Control

---

Hotkey port control allows you to provide KVM focus to a particular computer directly from the keyboard. The CS1708A / CS1716A provides the following hotkey port control features:

- ◆ Selecting the Active Port
- ◆ Auto Scan Mode Switching
- ◆ Skip Mode Switching
- ◆ Computer Keyboard / Mouse Reset

The following settings can also be controlled in *Hotkey* mode:

- ◆ Setting the Beeper
- ◆ Setting the Quick Hotkey
- ◆ Setting the OSD Hotkey
- ◆ Setting the Port Operating System
- ◆ Restoring the OSD Default Values

## Invoke Hotkey Mode

---

All hotkey operations begin by invoking *Hotkey* mode.<sup>1</sup> There are two possible keystroke sequences used to invoke *Hotkey* mode, though only one can be operational at any given time:

### Number Lock and Minus Keys

1. Hold down the **Num Lock** key;
2. Press and release the **minus** key;
3. Release the **Num Lock** key:

[Num Lock] + [-]

### Control and F12 Keys

1. Hold down the **Ctrl** key;
2. Press and release the **F12** key;
3. Release the **Ctrl** key:

[Ctrl] + [F12]

When *Hotkey* mode is active:

- ◆ A command line appears on the monitor screen. The command line prompt is the word *Hotkey*: in white text on a blue background, and displays the subsequent hotkey information that you key in.
- ◆ Ordinary keyboard and mouse functions are suspended – only hotkey compliant keystrokes (described in the sections that follow), can be input.

Pressing [Esc] exits *Hotkey* mode.

---

1. Make sure that the *Hotkey Command Mode* function is enabled and that you key in the appropriate *Hotkey*. See page 29 for details.

---



## Select the Active Port

---

Each KVM port is assigned a port ID (see *Port ID Numbering*, page 20). You can directly access any computer on the installation with a hotkey combination that specifies the port ID of the KVM port that a computer is connected to. To access a computer using hotkeys:

1. Invoke hotkey mode with the [**Num Lock**] + [-] or [**Ctrl**] + [**F12**] combination.
2. Key in the port ID.

The port ID numbers display on the command line as you key them in. If you make a mistake, use [**Backspace**] to erase the wrong number.

3. Press [**Enter**].

After you press [**Enter**], the KVM focus switches to the designated computer and you automatically exit hotkey mode.

---

**Note:** In hotkey mode, KVM focus will not switch to a port if an invalid switch or port number is entered. The hotkey command line will continue to display on the screen until you enter a valid switch and port number combination, or exit hotkey mode.

---

## Auto Scan Mode

---

*Auto Scan* automatically switches, at regular intervals, among all the KVM ports that have been set as accessible under *Scan-Skip Mode*, so that their activity can be monitored automatically. See *Scan-Skip Mode* on page 28 for more information.

### **Invoking Auto Scan:**

To start *Auto Scan*, key in the following Hotkey combination:

1. Invoke hotkey mode with the [**Num Lock**] + [-] or [**Ctrl**] + [**F12**] combination.
2. Press [**A**]. After you press **A**, then [**Enter**], you automatically exit hotkey mode, and enter *Auto Scan* mode.

- ◆ While you are in *Auto Scan* mode, you can pause the scanning in order to keep the focus on a particular computer either by pressing **P** or with a left click of the mouse. During the time that auto-scanning is paused, the command line displays: **Auto Scan: Paused**.

*Pausing* when you want to keep the focus on a particular computer is more convenient than exiting *Auto Scan* mode because when you resume scanning, you start from where you left off. If, on the other hand, you exited and restarted, scanning would start over from the very first computer on the installation.

To resume Auto Scanning, press any key or left-click. Scanning continues from where it left off.

- ◆ While *Auto Scan* mode is in effect, ordinary keyboard and mouse functions are suspended – only *Auto Scan* mode compliant keystrokes and mouse clicks can be input. You must exit *Auto Scan* mode in order to regain normal control of the console.
3. To exit *Auto Scan* mode press [**Esc**] or [**Spacebar**]. Auto-scanning stops when you exit *Auto Scan* mode.

## Skip Mode

---

This feature allows you to switch between computers in order to monitor them manually. You can dwell on a particular port for as long as you like – as opposed to auto-scanning, which automatically switches after a fixed interval. To invoke *Skip* mode, key in the following hotkey combination:

1. Invoke hotkey mode with the [**Num Lock**] + [-] or [**Ctrl**] + [**F12**] combination.
2. Key in [**Arrow**]
  - ◆ Where [Arrow] refers to one of the arrow keys. After you press an arrow, you automatically exit hotkey mode and enter *Skip* mode where you can switch ports as follows:

←	Skips to the first accessible port. (See <i>Scan/Skip Mode</i> , page 29, for information regarding accessible ports.)
→	Skips to the next accessible port.
↑	Skips to the last accessible port of the previous station.
↓	Skips to the first accessible port of the next station.

- ◆ Once you are in *Skip* mode, you can keep on skipping by pressing the arrow keys. You don't have to use the [Num Lock] + [-] combination again.
  - ◆ While *Skip* mode is in effect, ordinary keyboard and mouse functions are suspended – only *Skip* mode compliant keystrokes can be input. You must exit *Skip* mode in order to regain normal control of the console.
3. To exit *Skip* mode, press [**Esc**] or [**Spacebar**].

## Computer Keyboard / Mouse Reset

---

If the keyboard or mouse cease to function on the computer connected to the currently selected port, you can perform a keyboard / mouse reset on the computer. This function is essentially the same as unplugging and replugging the keyboard and mouse on the target computer. To perform a computer keyboard / mouse reset, key in the following hotkey combination:

1. Invoke hotkey mode with the **[Num Lock] + [-]** or **[Ctrl] + [F12]** combination.
2. Press **[F5]**.

After you press [F5] you automatically exit *Hotkey* mode and regain keyboard and mouse control on the computer connected to the KVM port. If you fail to regain keyboard / mouse control on the computer after pressing [F5], perform a console keyboard and mouse reset. For more information see *Port LEDs*, page 5.

## Hotkey Beeper Control

---

The beeper (see *Activate Beeper*, page 31) can be hotkey toggled on and off. To toggle the beeper, key in the following hotkey combination:

1. Invoke hotkey mode with the **[Num Lock] + [-]** or **[Ctrl] + [F12]** combination.
2. Press **[B]**.

After you press [B], the beeper toggles on or off. The command line displays *Beeper On* or *Beeper Off* for one second; then the message disappears and you automatically exit hotkey mode.

## Quick Hotkey Control

---

The *Quick Hotkey* (see *HOTKEY*, page 29) can be toggled between [Num Lock] + [-], and [Ctrl] + [F12]. To toggle the *Quick Hotkey*:

1. Invoke hotkey mode with the [Num Lock] + [-] or [Ctrl] + [F12] combination.
2. Press [H].

After you press [H], the command line displays *HOTKEY HAS BEEN CHANGED* for one second; then the message disappears and you automatically exit *Hotkey* mode.

## OSD Hotkey Control

---

The *OSD Hotkey* (see *OSD HOTKEY*, page 28) can be toggled between [Scroll Lock], [Scroll Lock] and [Ctrl], [Ctrl]. To toggle the *OSD Hotkey*, key in the following hotkey combination:

1. Invoke hotkey mode with the [Num Lock] + [-] or [Ctrl] + [F12] combination.
2. Press [T].

After you press [T], the command line displays *HOTKEY HAS BEEN CHANGED* for one second; then the message disappears and you automatically exit *Hotkey* mode.

## Port OS Control

---

A port's operating system can be changed to match that of the computer attached to the port. To change a port's operating system, key in the following hotkey combination:

1. Invoke hotkey mode with the **[Num Lock] + [-]** or **[Ctrl] + [F12]** combination.
2. Key in **[Function]**, where [Function] refers to one of the function keys in the following table:

Key	Description
F1	Sets the Port OS to Windows
F2	Sets the Port OS to Mac
F3	Sets the Port OS to Sun

After pressing a function key you automatically exit *Hotkey* mode.

## Restore Default Values

---

This administrator only hotkey restores the CS1708A / CS1716A default values. See *RESTORE DEFAULT VALUES*, page 31. To restore the default values, key in the following hotkey combination:

1. Invoke hotkey mode with the **[Num Lock] + [-]** or **[Ctrl] + [F12]** combination.
2. Press **[R]**.
3. Press **[Enter]**.

After you press [Enter], the command line displays *RESET TO DEFAULT SETTING* for three seconds; then the message disappears and you automatically exit *Hotkey* mode.

## Hotkey Summary Table

[Num Lock] + [-] or [Ctrl] + [F12]	[A] [Enter] or [Q] [Enter]	Invokes <i>Auto Scan</i> mode.  When <i>Auto Scan</i> mode is in effect, [P] or left-click pauses auto-scanning.  When auto-scanning is paused, pressing any key or another left-click resumes auto-scanning.
	[B]	Toggles the beeper on or off.
	[Esc] or [Spacebar]	Exits hotkey mode.
	[F1]	Set Operating System to Windows
	[F2]	Set Operating System to Mac
	[F3]	Set Operating System to Sun
	[F5]	Performs a keyboard / mouse reset on the target computer.
	[H]	Toggles the <i>Quick Hotkey</i> invocation keys between [Ctrl] + [F12] and [Num Lock] + [-].
	[R] [Enter]	This administrator only hotkey restores the switch's default values. See <i>RESTORE DEFAULT VALUES</i> , page 31.
	[SN][PN] [Enter]	Switches access to the computer that corresponds to that port ID.
	[T]	Toggles the <i>OSD Hotkey</i> between [Ctrl] [Ctrl] and [Scroll Lock] [Scroll Lock].
	[←]	Invokes <i>Skip</i> mode and skips from the current port to the first accessible port previous to it.
	[→]	Invokes <i>Skip</i> mode and skips from the current port to the next accessible port.
	[↑]	Invokes <i>Skip</i> mode and skips from the current port to the last accessible port of the previous station.
	[↓]	Invokes <i>Skip</i> mode and skips from the current port to the first accessible port of the next station.

This Page Intentionally Left Blank











# Chapter 6

## Keyboard Emulation

### Mac Keyboard

---

The PC compatible (101/104 key) keyboard can emulate the functions of the Mac keyboard. The emulation mappings are listed in the table below.

PC Keyboard	Mac Keyboard
[Shift]	Shift
[Ctrl]	Ctrl
	
[Ctrl] [1]	
[Ctrl] [2]	
[Ctrl] [3]	
[Ctrl] [4]	
[Alt]	Alt
[Print Screen]	F13
[Scroll Lock]	F14
	=
[Enter]	Return
[Backspace]	Delete
[Insert]	Help
[Ctrl] 	F15







---

**Note:** When using key combinations, press and release the first key (Ctrl), then press and release the activation key.

---

## Sun Keyboard

The PC compatible (101/104 key) keyboard can emulate the functions of the Sun keyboard when the control key [Ctrl] is used in conjunction with other keys. The corresponding functions are shown in the table below.

PC Keyboard	Sun Keyboard
[Ctrl] [T]	Stop
[Ctrl] [F2]	Again
[Ctrl] [F3]	Props
[Ctrl] [F4]	Undo
[Ctrl] [F5]	Front
[Ctrl] [F6]	Copy
[Ctrl] [F7]	Open
[Ctrl] [F8]	Paste
[Ctrl] [F9]	Find
[Ctrl] [F10]	Cut
[Ctrl] [1]	
[Ctrl] [2]	
[Ctrl] [3]	
[Ctrl] [4]	
[Ctrl] [H]	Help
	Compose
	

**Note:** When using key combinations, press and release the first key (Ctrl), then press and release the activation key.

# Chapter 7

## The Firmware Upgrade Utility

### Introduction

---

The purpose of the Windows-based Firmware Upgrade Utility is to provide an automated process for upgrading all CS1708A / CS1716A switches in an installation. The program comes as part of a Firmware Upgrade Package that is specific for each device.

As new firmware versions become available, new firmware upgrade packages are posted on our website. Check the website regularly to find the latest information and packages.

### Downloading the Firmware Upgrade Package

To download the firmware upgrade package:

1. From a computer that is not part of your KVM installation go to our Website and choose the model name that relates to your device. A list of available firmware upgrade packages appears.
2. Choose the firmware upgrade package that you wish to install (usually the most recent) and download it to your computer.

## Preparation

To prepare for the firmware upgrade, do the following:

1. Use the *Firmware Upgrade Cable* provided with this unit to connect a COM port on your computer to the *Firmware Upgrade Port* of your switch.

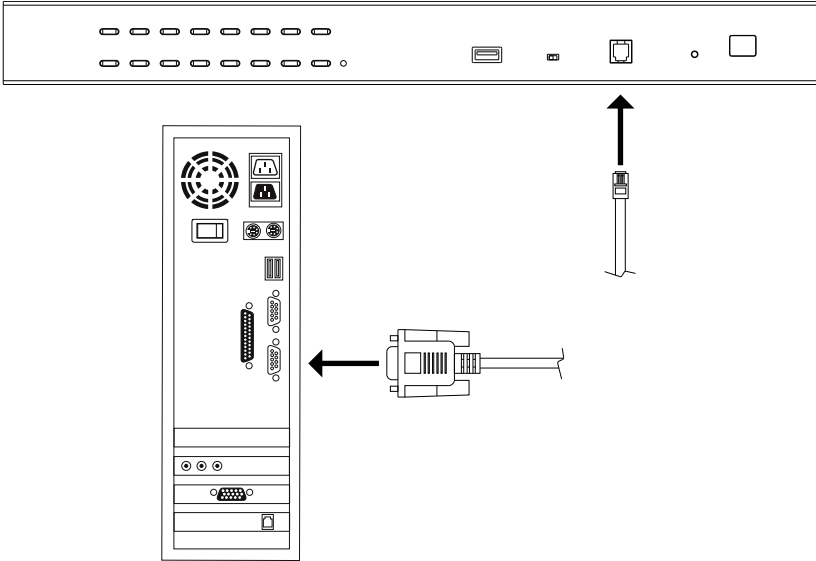

---

**Note:** On a daisy chained installation, the chained stations will automatically receive the upgrade via the daisy chain cables.

---

2. Shut down all the computers, but not the stations, on the KVM installation.
3. From your KVM switch console, login to the OSD as the administrator (see p. 23) and select the **F4 ADM** function.
4. Scroll down to FIRMWARE UPGRADE. Press **[Enter]**, then press **[Y]** to invoke *Firmware Upgrade* mode (see p. 33.)

---

## Starting the Upgrade

---

To upgrade the firmware:

1. Run the downloaded firmware upgrade package file either by double-clicking the file icon, or by opening a command line and entering the full path to it.

The *Firmware Upgrade Utility* welcome screen appears:

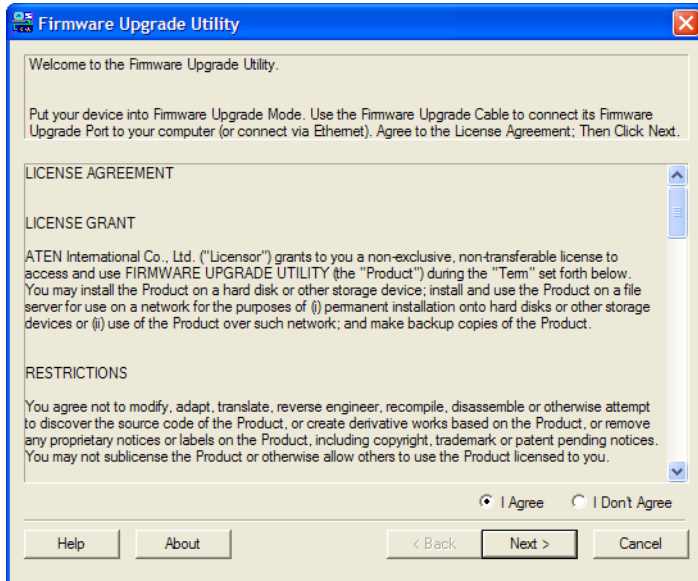

---

**Note:** The screens shown in this section are for reference only. The wording and layout of the actual screens put up by the *Firmware Upgrade Utility* may vary slightly from these examples.

---

2. Read and *Agree* to the License Agreement (enable the I Agree radio button).
3. Click **Next** to continue. The *Firmware Upgrade Utility* main screen appears. The devices capable of being upgraded are listed in the *Device List* panel:

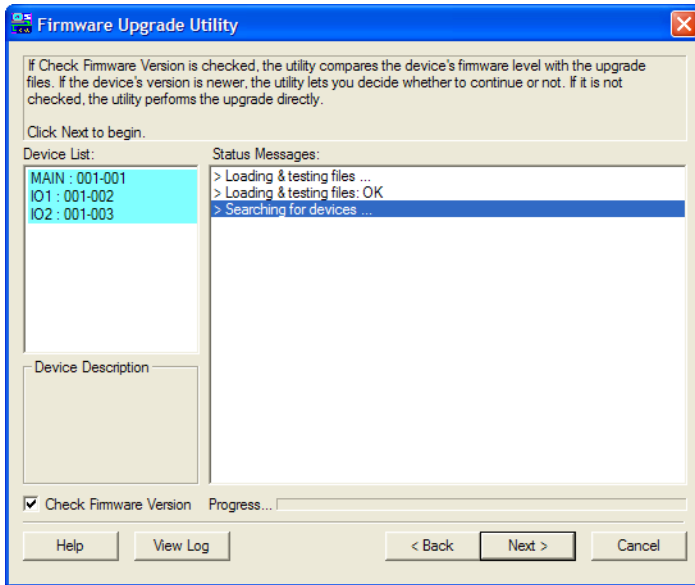

4. Click **Next** to perform the upgrade.

If you enabled *Check Firmware Version*, the Utility compares the device's firmware level with that of the upgrade files. If it finds that the device's version is higher than the upgrade version, it brings up a dialog box informing you of the situation and gives you the option to continue or cancel.

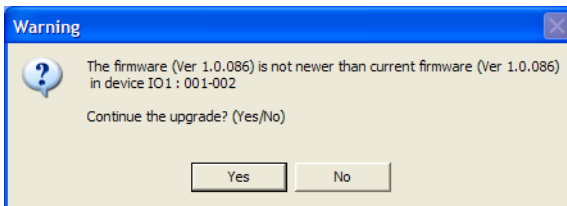

If you didn't enable *Check Firmware Version*, the Utility installs the upgrade files without checking whether they are a higher level, or not.

As the upgrade proceeds, status messages appear in the *Status Messages* panel, and the progress toward completion is shown on the *Progress* bar.

## Upgrade Succeeded

After the upgrade has completed, a screen appears to inform you that the procedure was successful:

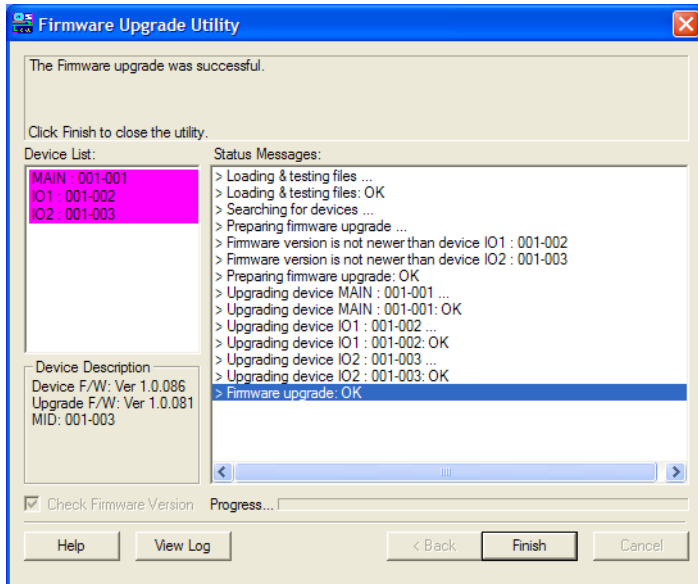

Click **Finish** to close the *Firmware Upgrade Utility*.

## Upgrade Failed

If the *Upgrade Succeeded* screen doesn't appear, it means that the upgrade failed to complete successfully. See the next section, *Firmware Upgrade Recovery*, for how to proceed.

## Firmware Upgrade Recovery

---

There are three conditions that call for firmware upgrade recovery:

- ◆ When a firmware upgrade is manually aborted.
- ◆ When the mainboard firmware upgrade fails.
- ◆ When the I/O firmware upgrade fails.

To perform a firmware upgrade recovery, do the following:

1. Power off the switch. If it is part of a daisy chain, disconnect it from the chain.
2. Connect the *Firmware Upgrade Cable* to its *Firmware Upgrade Port*.
3. Slide the *Firmware Upgrade Recovery Switch* to the **Recover** position.
4. Power the switch back on and repeat the upgrade procedure.
5. After the switch has been successfully upgraded, power it off, and slide the *Firmware Upgrade Recovery Switch* back to the **Normal** position.
6. If the switch is part of a daisy chain, replace it in the chain.
7. Power the switch back on.



# Appendix

## Safety Instructions

---

### General

- ◆ Read all of these instructions. Save them for future reference.
- ◆ Follow all warnings and instructions marked on the device.
- ◆ Do not place the device on any unstable surface (cart, stand, table, etc.). If the device falls, serious damage will result.
- ◆ Do not use the device near water.
- ◆ Do not place the device near, or over, radiators or heat registers.
- ◆ The device cabinet is provided with slots and openings to allow for adequate ventilation. To ensure reliable operation, and to protect against overheating, these openings must never be blocked or covered.
- ◆ The device should never be placed on a soft surface (bed, sofa, rug, etc.) as this will block its ventilation openings. Likewise, the device should not be placed in a built in enclosure unless adequate ventilation has been provided.
- ◆ Never spill liquid of any kind on the device.
- ◆ Unplug the device from the wall outlet before cleaning. Do not use liquid or aerosol cleaners. Use a damp cloth for cleaning.
- ◆ The device should be operated from the type of power source indicated on the marking label. If you are not sure of the type of power available, consult your dealer or local power company.
- ◆ The device is designed for IT power distribution systems with 230V phase-to-phase voltage.
- ◆ To prevent damage to your installation it is important that all devices are properly grounded.
- ◆ The device is equipped with a 3-wire grounding type plug. This is a safety feature. If you are unable to insert the plug into the outlet, contact your electrician to replace your obsolete outlet. Do not attempt to defeat the purpose of the grounding-type plug. Always follow your local/national wiring codes.
- ◆ Do not allow anything to rest on the power cord or cables. Route the power cord and cables so that they cannot be stepped on or tripped over.

*(Continues on next page.)*

*(Continued from previous page.)*

- ◆ If an extension cord is used with this device make sure that the total of the ampere ratings of all products used on this cord does not exceed the extension cord ampere rating. Make sure that the total of all products plugged into the wall outlet does not exceed 15 amperes.
- ◆ To help protect your system from sudden, transient increases and decreases in electrical power, use a surge suppressor, line conditioner, or un-interruptible power supply (UPS).
- ◆ Position system cables and power cables carefully; Be sure that nothing rests on any cables.
- ◆ Never push objects of any kind into or through cabinet slots. They may touch dangerous voltage points or short out parts resulting in a risk of fire or electrical shock.
- ◆ Do not attempt to service the device yourself. Refer all servicing to qualified service personnel.
- ◆ If the following conditions occur, unplug the device from the wall outlet and bring it to qualified service personnel for repair.
  - ◆ The power cord or plug has become damaged or frayed.
  - ◆ Liquid has been spilled into the device.
  - ◆ The device has been exposed to rain or water.
  - ◆ The device has been dropped, or the cabinet has been damaged.
  - ◆ The device exhibits a distinct change in performance, indicating a need for service.
  - ◆ The device does not operate normally when the operating instructions are followed.
- ◆ Only adjust those controls that are covered in the operating instructions. Improper adjustment of other controls may result in damage that will require extensive work by a qualified technician to repair.
- ◆ Do not connect the RJ-11 connector marked “UPGRADE” to a public telecommunication network.

## **Rack Mounting**

- ◆ Before working on the rack, make sure that the stabilizers are secured to the rack, extended to the floor, and that the full weight of the rack rests on the floor. Install front and side stabilizers on a single rack or front stabilizers for joined multiple racks before working on the rack.
- ◆ Always load the rack from the bottom up, and load the heaviest item in the rack first.
- ◆ Make sure that the rack is level and stable before extending a device from the rack.
- ◆ Do not overload the AC supply branch circuit that provides power to the rack. The total rack load should not exceed 80 percent of the branch circuit rating.
- ◆ Make sure that all equipment used on the rack – including power strips and other electrical connectors – is properly grounded.
- ◆ Ensure that proper airflow is provided to devices in the rack.
- ◆ Ensure that the operating ambient temperature of the rack environment does not exceed the maximum ambient temperature specified for the equipment by the manufacturer
- ◆ Do not step on or stand on any device when servicing other devices in a rack.

## Technical Support

---

### International

- ◆ For online technical support – including troubleshooting, documentation, and software updates: **<http://support.aten.com>**
- ◆ For telephone support, see *Telephone Support*, page iii:

### North America

Email Support		<a href="mailto:support@aten-usa.com">support@aten-usa.com</a>
Online Technical Support	Troubleshooting Documentation Software Updates	<a href="http://www.aten-usa.com/support">http://www.aten-usa.com/support</a>
Telephone Support		1-888-999-ATEN ext 4988

When you contact us, please have the following information ready beforehand:

- ◆ Product model number, serial number, and date of purchase.
- ◆ Your computer configuration, including operating system, revision level, expansion cards, and software.
- ◆ Any error messages displayed at the time the error occurred.
- ◆ The sequence of operations that led up to the error.
- ◆ Any other information you feel may be of help.

# Specifications

Function		CS1708A	CS1716A
Computer Connections	Direct	8	16
	Max	256 (via daisy chain)	512 (via daisy chain)
Port Selection		On-screen display (OSD); Hotkeys; Pushbutton switches	
Connectors	Console Port	1 x SPHD-18	
	KVM Ports	8 x SPHD-15	16 x SPHD-15
	Daisy Chain	2 x DB-25	
	FW Upgrade	1 x RJ-11	
	USB Port	1 x USB Type A	
	Power	1 x DC Jack	
LEDs	On Line	8 (Orange)	16 (Orange)
	Selected	8 (Green)	16 (Green)
	Station ID	1 x 2-digit, 7-segment (Orange)	
	Power	1 (Dark Green)	
Switches	FW Upgr. Rec.	1 x Slide	
	Port Selection	8 x Pushbutton	16 x Pushbutton
Emulation	Keyboard/Mouse	PS/2, USB	
Video		2048 x 1536; DDC2B	
Scan Interval (OSD Select)		User Specified: 1–255 sec.	
Power Consumption		DC 5.3 V; 5 W	DC 5.3 V; 6.6 W
Environment	Operating Temp.	0–50° C	
	Storage Temp.	-20–60° C	
	Humidity	0–80% RH, Non-condensing	
Physical Properties	Housing	Metal	
	Weight	2.66 kg	2.85 kg
	L x W x H	43.30 x 16.00 x 4.40 cm	

## Connection Tables

---

The following tables indicate the relationship between the number of switches and the number of computers that they control.

### CS1708A

No.	Computers	No.	Computers	No.	Computers	No.	Computers
1	1 - 8	9	65 - 72	17	129 - 136	25	193 - 200
2	9 - 16	10	73 - 80	18	137 - 144	26	201 - 208
3	17 - 24	11	81 - 88	19	145 - 152	27	209 - 216
4	25 - 32	12	89 - 96	20	153 - 160	28	217 - 224
5	33 - 40	13	97 - 104	21	161 - 168	29	225 - 232
6	41 - 48	14	105 - 112	22	169 - 176	30	233 - 240
7	49 - 56	15	113 - 120	23	177 - 184	31	241 - 248
8	57 - 64	16	121 - 128	24	185 - 192	32	249 - 256

### CS1716A

No.	Computers	No.	Computers	No.	Computers	No.	Computers
1	1 - 16	9	129 - 144	17	257 - 272	25	385 - 400
2	17 - 32	10	145 - 160	18	273 - 288	26	401 - 416
3	33 - 48	11	161 - 176	19	289 - 304	27	417 - 432
4	49 - 64	12	177 - 192	20	305 - 320	28	433 - 448
5	65 - 80	13	193 - 208	21	321 - 336	29	449 - 464
6	81 - 96	14	209 - 224	22	337 - 352	30	465 - 480
7	97 - 112	15	225 - 240	23	353 - 368	31	481 - 496
8	113 - 128	16	241 - 256	24	369 - 384	32	497 - 512

## Supported KVM Switches

The table below lists KVM switches that are compatible with the CS1708A / CS1716A and the type of expansion that they use. (KVM switches listed below are sold separately. Contact your dealer for details.)

Expansion Type	Brand	Model	Name
Daisy Chain	ATEN	ACS1208A	8 Port PS/2 KVM Switch
		ACS1216A	16 Port PS/2 KVM Switch
		CL1208	8 Port USB / PS/2 LCD KVM Switch
		CL1216	16 Port USB / PS/2 LCD KVM Switch
		CS1708	8 Port USB KVM Switch
		CS1716	16 Port USB KVM Switch
		CS1708A	8 Port USB / PS/2 KVM Switch
		CS1716A	16 Port USB / PS/2 KVM Switch
	ALTUSEN	KH1508	8-Port High-Density KVM Switch
		KH1516	16-Port High-Density KVM Switch

Please keep in mind the following limitations when installing more than one KVM switch:

- ◆ The maximum distance between the CS1708A / CS1716A and the last switch in the daisy chain cannot exceed 150 meters, regardless of the number of switches in the daisy chain.
- ◆ The maximum distance between any two KVM switches in the daisy chain cannot exceed 15 meters.

## Restoring Factory Default Settings

---

You can restore the factory default settings (listed on the next page) for the CS1708A / CS1716A. With this procedure, the administrator and all user accounts are removed from the system. All port names and setting are also removed.

---

**Note:** A jumper cap is required when performing this procedure.

---

1. Unplug the CS1708A / CS1716A power adapter.
2. Remove the cover of the CS1708A / CS1716A.
3. Place a jumper cap over pins 1-2 of the J17 jumper on the mainboard.

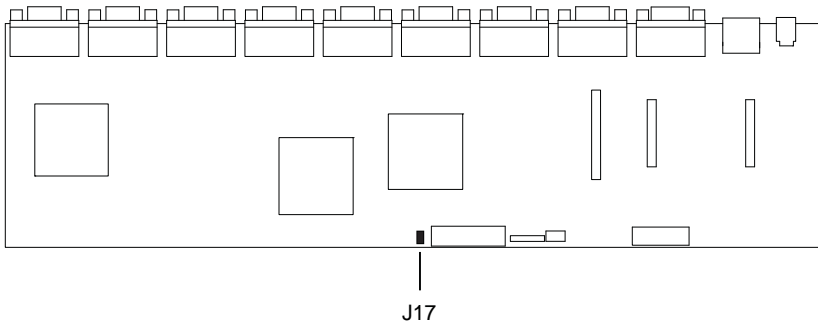

4. Plug in the CS1708A / CS1716A power adapter. The following directions appear on the KVM console screen:

```
USERNAME AND PASSWORD INFORMATION AND PORT/USER  
INFORMATION HAS BEEN CLEARED. PLEASE POWER OFF THE  
SWITCH, REMOVE THE JUMPER, CLOSE THE CASE, THEN  
RESTART.
```

5. Unplug the power adapter again.
6. Remove the jumper cap from pins 1-2 of the J17 jumper.
7. Replace the cover on the KVM switch.
8. Plug in the CS1708A / CS1716A power adapter.
9. You should now use the default username and password to log in to the CS1708A / CS1716A.



## OSD Factory Default Settings

The factory default settings are as follows:

Setting	Default
OSD Hotkey	[Scroll Lock] [Scroll Lock]
Port ID Display Position	Upper Left Corner
Port ID Display Duration	3 Seconds
Port ID Display Mode	Port Number plus Port Name
Scan Duration	5 Seconds
Scan-Skip Mode	All
Screen Blanker	0 (Disabled)
Logout Timeout	0 (Disabled)
Beeper	Y (Activated)
Accessible Ports	F (Full) For all Users on all Ports

## About SPHD Connectors



This product uses SPHD connectors for its KVM and/or Console ports. We have specifically modified the shape of these connectors so that only KVM cables that we have designed to work with this product can be connected.

## Troubleshooting

---

### Overview

Operation problems can be due to a variety of causes. The first step in solving them is to make sure that all cables are securely attached and seated completely in their sockets.

In addition, updating the product's firmware may solve problems that have been discovered and resolved since the prior version was released. If your product is not running the latest firmware version, we strongly recommend that you upgrade. See *The Firmware Upgrade Utility*, page 49, for upgrade details.

Symptom	Possible Cause	Action
Erratic behavior.	Unit not receiving enough power.	Check that the power adapter that was supplied with the unit is plugged in and functioning properly.
Mouse and/or Keyboard not responding.	Improper mouse and/or keyboard reset.	Unplug the cable(s) from the console port(s), then plug it/them back in.
All Station IDs display as 01.	Station 1 has suddenly lost power.	Wait a few seconds for the system to reinitialize the station sequence and display the proper IDs.

## Limited Warranty

---

IN NO EVENT SHALL THE DIRECT VENDOR'S LIABILITY EXCEED THE PRICE PAID FOR THE PRODUCT FROM DIRECT, INDIRECT, SPECIAL, INCIDENTAL, OR CONSEQUENTIAL DAMAGES RESULTING FROM THE USE OF THE PRODUCT, DISK, OR ITS DOCUMENTATION.

The direct vendor makes no warranty or representation, expressed, implied, or statutory with respect to the contents or use of this documentation, and especially disclaims its quality, performance, merchantability, or fitness for any particular purpose.

The direct vendor also reserves the right to revise or update the device or documentation without obligation to notify any individual or entity of such revisions, or update. For further inquiries, please contact your direct vendor.

## A

- Activate Beeper, 31
- ADM, 30
- Auto Scanning, 35
  - Invoking Auto Scan, 40
  - Pausing Auto Scan, 40
  - Scan Duration, 28
  - Stopping, 40

## B

- Beeper
  - Activate, 31
  - Control, 42
  - Hotkey Control, 42, 43
- BRC, 34
- Broadcast Mode, 34

## C

- Clear the Name List, 31
- Components, 4
- computer connection tables, 60
- console cable installation, 15
- CS1708A / CS1716A
  - computer connection tables, 60
  - front view, 4
  - rear view, 6

## D

- daisy chain installation, 16
- desktop mounting, 8
- Display Emulation Technology, 2

## E

- EDID, 2
- Edit Port Names, 31

## F

- F1 GOTO, 26
- F2 LIST, 27
- F3 SET, 28
- F4 ADM, 30
- F5 SKP, 33
- F6 BRC, 34
- F7 SCAN, 35
- F8 LOU, 36
- factory default settings, 63
  - restoring, 62
- Firmware upgrade
  - OSD setting, 33
  - port, 50
  - recovery, 54

## G

- GOTO, 26

## H

- hardware requirements
  - cables, 3
  - computers, 3
  - consoles, 3
- Hot Plugging, 19
  - Console Ports, 19
  - KVM ports, 19
- Hotkey
  - Beeper Control, 42, 43
  - Command Mode, 29
  - OSD, 28
  - Selecting the Active Port, 39
  - Summary Table, 45
- Hotkey Mode
  - exiting, 38
  - invoking, 38
- Hotkey Port Control, 37

**I**

- installation
  - daisy chain, 16
  - single level, 14
- Invoking Hotkey Mode, 38

**K**

- Keyboard Emulation
  - Mac, 47
  - Sun, 48
- KVM adapter cables, 3

**L**

- LIST, 27
- Logout, 36
- Logout Timeout, 31
- LOUT, 36

**M**

- mounting
  - desktop, 8
  - rack, 8

**O**

- Online Registration, iii
- OSD
  - factory default settings, 63
  - Functions, 26
  - Hotkey, 23, 28
  - Logout, 36
  - Main Screen, 23, 24
  - Main Screen Headings, 25
  - Navigation, 25
  - Overview, 23
  - Password, 23

**P**

- Password, 23
- Pause, 35
- Port ID

- Display Duration, 28
- Display Mode, 28
- Display Position, 28
- Numbering, 20

- Port Names, 31
- Port Selection, 20
  - Manual, 20

## ports

- quick view, 32
- set operating system, 32
- Powering Off and Restarting, 21

**Q**

- quick view ports, 32

**R**

- rack mounting, 8
  - front, 9
  - rear, 11
  - safety information, 57

## Requirements

- OS Support, 4
- Reset Station IDs, 32
- Restore Default Values, 31
- restoring factory defaults, 62
- RoHS, ii

**S**

- safety instructions
  - general, 55
  - rack mounting, 57
- SCAN, 35
- Scan Duration, 28
- SCAN/SKIP MODE, 29
- Screen Blanker, 29
- Selecting the Active Port, 39
- SET, 28
  - Accessible Ports, 30
  - Logout Timeout, 31
  - Quick View Ports, 32

- single level installation, 14
- SJ/T 11364-2006, ii
- Skip Mode, 33, 41
- Specifications, 59
- stacking, 8
- Station IDs
  - Reset, 32
- Switching Station Positions, 19

## **T**

- Technical Support, 58
- Telephone support, iii
- Timeout, 31
- Troubleshooting, 64

## **U**

- User Notice, iii