

PE8216/PE8324

ECO PDU

- As part of its NRGence line, ATEN has developed a new generation of green energy power distribution units (eco PDUs) to effectively increase the efficiency of data center power usage. The NRGence PE8216 / PE8324 eco PDUs are intelligent PDUs that contain 16, or 24 AC outlets and are available in various IEC socket configurations. Models in the advanced PE8 ranges feature NRGence's proactive overload protection, which automatically powers off the last outlet that caused the current overload.

NRGence eco PDUs provide secure, centralized, intelligent, power management (power on, off, cycle) of data center IT equipment (servers, storage systems, KVM switches, network devices, serial data devices, etc.), as well as the ability to monitor the center's health environment via sensors



NRGence eco PDUs offer remote power control combined with real-time power measurement – allowing you to control and monitor the power status of devices attached to the PDUs, either at the PDU device, bank, or outlet level, depending on the model, from practically any location via a TCP/IP connection.

The power status of each outlet can be set individually, allowing users to switch each device On/Off. The eco PDU also offers comprehensive power analysis reports which can separate departments and locations, providing precise measurements of current, voltage, power and watt-hour in a real-time display. Installation and operation is fast and easy: plugging cables into their appropriate ports and user-friendly browser-based configuration and management is all that is entailed. Since the eco PDU firmware is upgradeable over the Net, you can stay current with the latest functionality improvements simply by downloading updates from our website as they become available.

NRGence eco PDU supports any 3rd party V3 SNMP Manager Software and NRGence eco Sensors (eco PDU Manager Software). eco Sensors provides you with an easy method for managing multiple devices, offering an intuitive and user-friendly Graphical User Interface that allows you to configure a PDU device and monitor power status of the equipment connected to it.

With its advanced security features and ease of operation, the eco PDU is the most convenient, most reliable, and most cost effective way to remotely manage power access for multiple computer installations and allocate power resources in the most efficient way possible.

PE8216B ECO PDU

Description:	100-240V 20A 0U 16-Outlet PDU
Function:	16-Outlet Metering, 16-Outlet Switching Control & 1-Bank Metering
Input Power Plug:	NEMA 6-20P 
Power Capacity:	4.2 kW
Socket Configuration:	IEC 60320 C19 (2)  IEC 60320 C13 (14) 

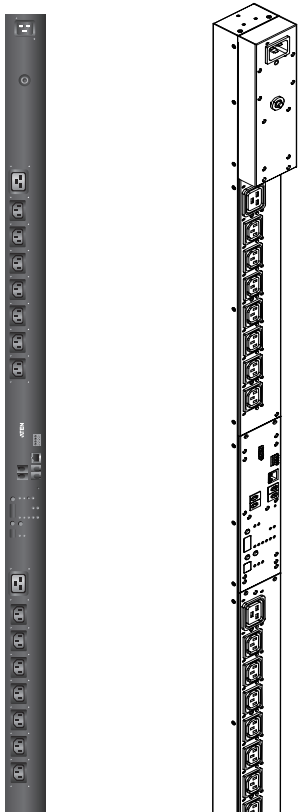

Features

Connections

- Supports 10/100Mbit Ethernet Interface
- Supports TCP/IP, UDP, HTTP, HTTPS, SSL, DHCP, ARP, NTP, DNS, Telnet, Auto Sense, Ping, SNMP V1,V2&V3
- Supports three-level account/password security, IP/MAC filter, 128 bit SSL, RADIUS
- Supports, eco Sensors, multiple Browsers (IE, Firefox, Chrome, Safari)

Metering

- PDU and outlet level power metering and monitoring
- Environment monitoring – supports external temperature/temperature & humidity sensors for rack temperature and humidity monitoring
- Current, voltage, power, power dissipation, temperature, and humidity metering and threshold level setting
- Support door sensor

Outlet Switch Control

- Remote power outlet control (On/Off, Power Cycle) by individual outlets and outlet groups
- Outlet group support at the PDU
- Supports multiple power control methods – Wake on LAN, System After AC Back, Kill the Power
- Power-On sequencing – users can set the power-on sequence and delay time for each outlet to allow equipment to be powered on in the correct order
- Proactive overload protection(POP) – automatically powers off the last outlet that caused the current overload *Patent Pending!*

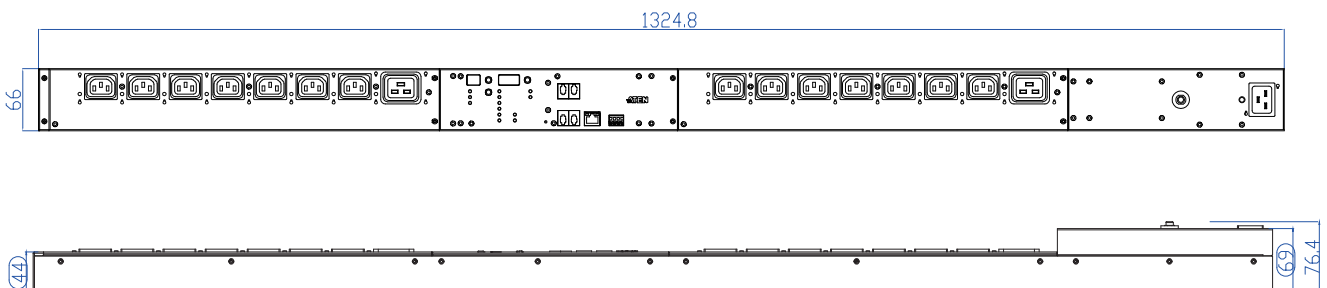

Specifications

Model	PE8216B
Electrical	
Nominal Input Voltage	100 – 240 VAC
Maximum Input Current	20A Max ; 16A (UL de-rated)
Input Frequency	50-60 Hz
Input Connection	1 x NEMA 6-20P
Input Power	4160 VA(Max) 3328 VA (UL de-rated) Total : 14 x IEC320 C13 + 2 x IEC320 C19
Outlet Type	Bank1-1 : Outlet 1 – 8 ; 7 x C13 + 1 x C19 Bank1-2 : Outlet 9 – 16 ; 7 x C13 + 1 x C19
Nominal Output Voltage	100 – 240 VAC
Maximum Output Current (Outlet)	C13 : 15A (Max) 12A(UL de-rated) C19 : 20A (Max) 16A(UL de-rated)
Maximum Output Current (Bank)	20A(Max) 16A (UL de-rated)
Maximum Output Current (Total)	20A(Max) 16A (UL de-rated)
Breakers	1 x 20A Non-Fuse breaker
Metering	Per Outlet Level Current, Voltage, VA, PF, KWh Monitoring
Outlet Switch	Yes
Environment Sensor Port	4
Metering Accuracy	Voltage Range: 100VAC ~ 250VAC +/-1% Power Range: 100W ~ 5000W +/- 2% Current Range: 0.1A~1A +/- 0.1A, 1A~20A +/-1%
Mechanical	
Dimension (H x W x D)	132.5 x 6.6 x 4.4 cm
Shipping Dimensions (H x W x D)	142 x 16 x 17 cm
Weight/Shipping Weight	3.9 / 7.9 kg
Power Cord Length	1.6 m
Environmental	
Temperature (Operating / Storage)	0 – 50°C / -20 – 60°C
Humidity (Operating & Storage)	0 – 80% RH, Non-Condensing
Compliance	
EMC Verification	FCC Part 15 Class A, Others by Reuest
Safety Verification	TUV-CB, Others by Reuest

Package Contents

1. PE8216B
2. Standard Rack Mount Kit
3. Quick Start Guide
4. CD-ROM (Manual, eco Sensors Software)
5. Power Cord



Rack Mount Kit

Optional Accessories

Environment Sensors

Part No.	Sensor
EA1140	Temperature
EA1240	Temperature / Humidity
EA1340	Differential Pressure / Temperature
EA1440	Photo Door Sensor
EA1441	Inductive Proximity Door Sensor

Cable Holders

Part No.	Description
2X-EA07	Lok-U-Plug Cable Holder (10 pcs per pack) Patent Pending!
2X-EA08	Lok-U-Plug Installation Tool (4 pcs per pack)

• Lok-U-Plug Installation



Mounting Kit



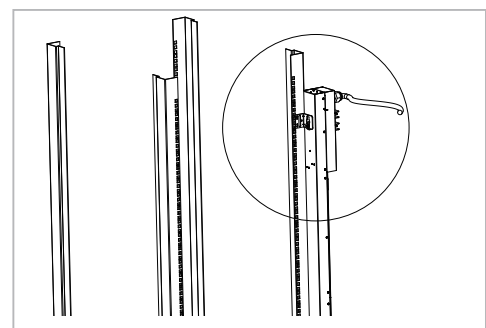

Button Mount Kit (2X-017G)

• Button Mount Installation



PE8216G ECO PDU

Description:	100-240V 16A 0U 16-Outlet PDU
Function:	16-Outlet Metering, 16-Outlet Switching Control & 1-Bank Metering
Input Power Plug:	IEC 60320 C20 
Power Capacity:	3.7 kW
Socket Configuration:	IEC 60320 C19 (2)  IEC 60320 C13 (14) 

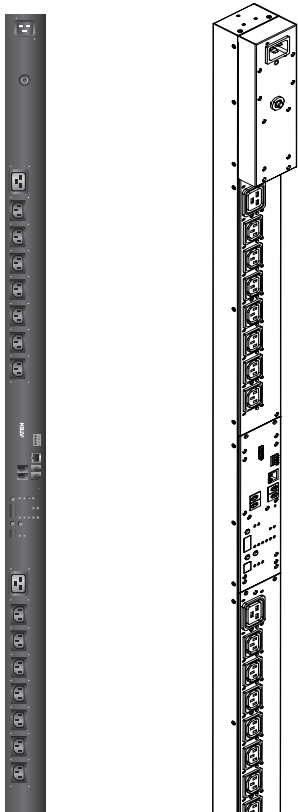

Features

Connections

- Supports 10/100Mbit Ethernet Interface
- Supports TCP/IP, UDP, HTTP, HTTPS, SSL, DHCP, ARP, NTP, DNS, Telnet, Auto Sense, Ping, SNMP V1,V2&V3
- Supports three-level account/password security, IP/MAC filter, 128 bit SSL, RADIUS
- Supports, eco Sensors, multiple Browsers (IE, Firefox, Chrome, Safari)

Metering

- PDU and outlet level power metering and monitoring
- Environment monitoring – supports external temperature/temperature & humidity sensors for rack temperature and humidity monitoring
- Current, voltage, power, power dissipation, temperature, and humidity metering and threshold level setting
- Support door sensor

Outlet Switch Control

- Remote power outlet control (On/Off, Power Cycle) by individual outlets and outlet groups
- Outlet group support at the PDU
- Supports multiple power control methods – Wake on LAN, System After AC Back, Kill the Power
- Power-On sequencing – users can set the power-on sequence and delay time for each outlet to allow equipment to be powered on in the correct order
- Proactive overload protection(POP) – automatically powers off the last outlet that caused the current overload *Patent Pending!*

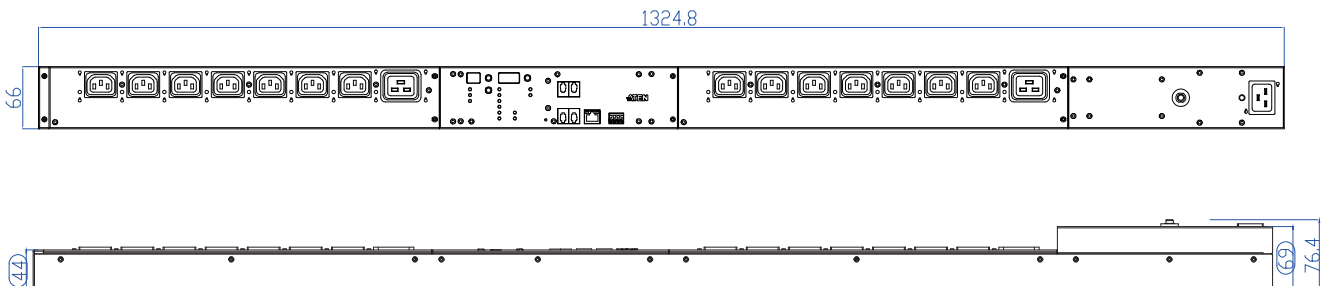

Specifications

Model	PE8216G
Electrical	
Nominal Input Voltage	100 – 240 VAC
Maximum Input Current	16A Max
Input Frequency	50-60 Hz
Input Connection	1 x IEC60320 C20
Input Power	3680 VA(Max)
Outlet Type	Total : 14 x IEC320 C13 + 2 x IEC320 C19 Bank1-1 : Outlet 1 – 8 ; 7 x C13 + 1 x C19 Bank1-2 : Outlet 9 – 16 ; 7 x C13 + 1 x C19
Nominal Output Voltage	100 – 240 VAC
Maximum Output Current (Outlet)	C13 : 10A (Max) C19 : 16A (Max) , TUV De-rated 15A(Max)
Maximum Output Current (Bank)	16A(Max), TUV De-rated 15A(Max)
Maximum Output Current (Total)	16A(Max), TUV De-rated 15A(Max)
Breakers	1 x 16A Non-Fuse breaker
Metering	Per Outlet Level Current, Voltage, VA, PF, KWh Monitoring
Outlet Switch	Yes
Environment Sensor Port	4
Metering Accuracy	Voltage Range: 100VAC ~ 250VAC +/-1% Power Range: 100W ~ 5000W +/- 2% Current Range: 0.1A~1A +/- 0.1A, 1A~20A +/-1%
Mechanical	
Dimension (H x W x D)	132.5 x 6.6 x 4.4 cm
Shipping Dimensions (H x W x D)	142 x 16 x 17 cm
Weight/Shipping Weight	3.9 / 7.9 kg
Power Cord Length	1.6 m
Environmental	
Temperature (Operating / Storage)	0 – 40°C / -20 – 60°C
Humidity (Operating & Storage)	0 – 80% RH, Non-Condensing
Compliance	
EMC Verification	CE, Others by Request
Safety Verification	TUV-CB, CE-LVD, Others by Request

Package Contents

1. PE8216G
2. Standard Rack Mount Kit
3. Quick Start Guide
4. CD-ROM (Manual, eco Sensors Software)
5. Power Cord



Rack Mount Kit

Optional Accessories

Environment Sensors

Part No.	Sensor
EA1140	Temperature
EA1240	Temperature / Humidity
EA1340	Differential Pressure / Temperature
EA1440	Photo Door Sensor
EA1441	Inductive Proximity Door Sensor

Cable Holders

Part No.	Description
2X-EA07	Lok-U-Plug Cable Holder (10 pcs per pack) Patent Pending!
2X-EA08	Lok-U-Plug Installation Tool (4 pcs per pack)

• Lok-U-Plug Installation



Mounting Kit



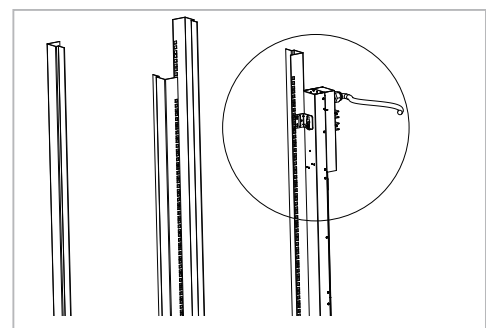

Button Mount Kit (2X-017G)

• Button Mount Installation



PE8324B ECO PDU

Description:	100-240V 30A 0U 24-Outlet PDU
Function:	24-Outlet Metering, 24-Outlet Switching Control & 2-Bank Metering
Input Power Plug:	NEMA L6-30P 
Power Capacity:	6.2 kW
Socket Configuration:	IEC 60320 C19 (3)  IEC 60320 C13 (21) 

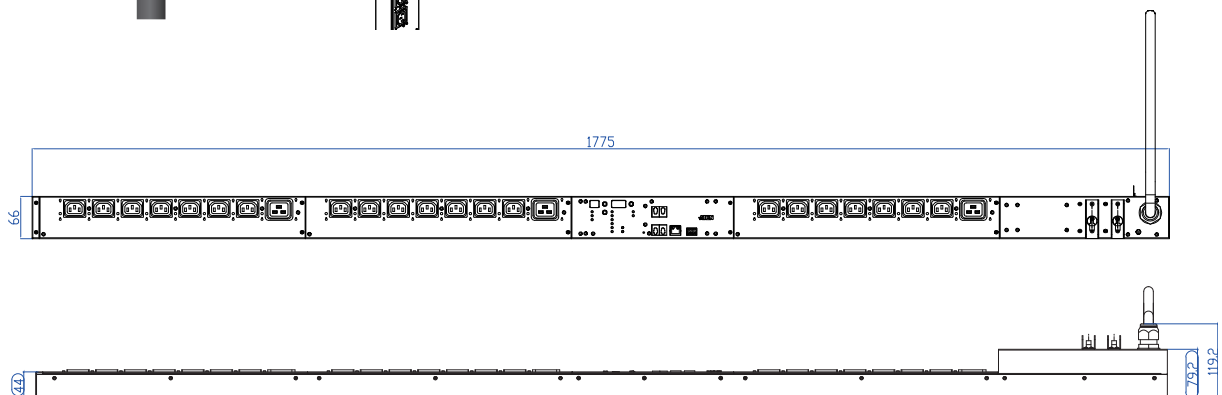
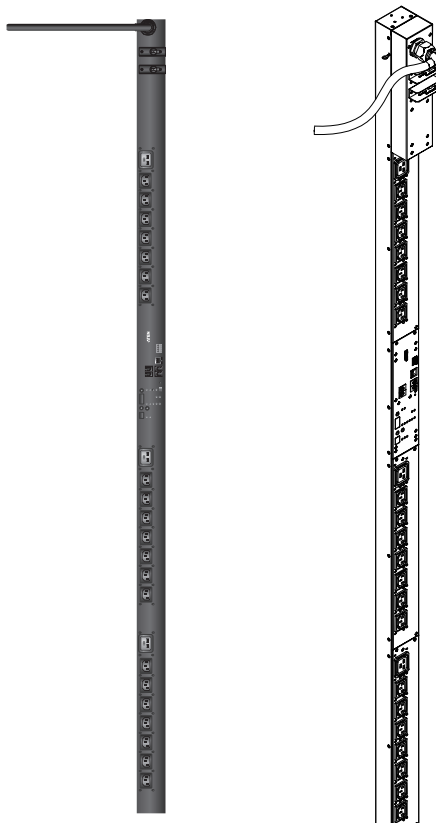

Features

Connections

- Supports 10/100Mbit Ethernet Interface
- Supports TCP/IP, UDP, HTTP, HTTPS, SSL, DHCP, ARP, NTP, DNS, Telnet, Auto Sense, Ping, SNMP V1,V2&V3,
- Supports three-level account/password security, IP/MAC filter, 128 bit SSL, RADIUS
- Supports, eco Sensors, multiple Browsers (IE, Firefox, Chrome, Safari)

Metering

- PDU and outlet level power metering and monitoring
- Environment monitoring – supports external temperature/temperature & humidity sensors for rack temperature and humidity monitoring
- Current, voltage, power, power dissipation, temperature, and humidity metering and threshold level setting
- Support door sensor

Outlet Switch Control

- Remote power outlet control (On/Off, Power Cycle) by individual outlets and outlet groups
- Outlet group support at the PDU
- Supports multiple power control methods – Wake on LAN, System After AC Back, Kill the Power
- Power-On sequencing – users can set the power-on sequence and delay time for each outlet to allow equipment to be powered on in the correct order
- Proactive overload protection(POP) – automatically powers off the last outlet that caused the current overload *Patent Pending!*

Model	PE8324B
Electrical	
Nominal Input Voltage	100 – 240 VAC
Maximum Input Current	30A Max ; 24A (UL de-rated)
Input Frequency	50-60 Hz
Input Connection	NEMA L6-30P
Input Power	6240 VA(Max) 4992 VA (UL de-rated)
Outlet Type	Total : 21 x IEC320 C13 + 3 x IEC320 C19 Bank1-1 : Outlet 1 – 8 ; 7 x C13 + 1 x C19 Bank1-2 : Outlet 9 – 16 ; 7 x C13 + 1 x C19 Bank2 : Outlet 17 – 24 ; 7 x C13 + 1 x C19
Nominal Output Voltage	100 – 240 VAC
Maximum Output Current (Outlet)	C13 : 15A (Max) 12A(UL de-rated) C19 : 15A (Max) 12A(UL de-rated)
Maximum Output Current (Bank)	15A(Max) 12A (UL de-rated)
Maximum Output Current (Total)	30A(Max) 24A (UL de-rated)
Breakers	2 x 16A UL489 Breaker
Metering	Per Outlet Level Current, Voltage, VA, PF, KWh Monitoring
Outlet Switch	Yes
Environment Sensor Port	4
Metering Accuracy	Voltage Range: 100VAC ~ 250VAC +/-1% Power Range: 100W ~ 5000W +/- 2% Current Range: 0.1A~1A +/- 0.1A, 1A~20A +/-1%
Mechanical	
Dimension (H x W x D)	177.5 x 6.6 x 4.4 cm
Shipping Dimensions (H x W x D)	189 x 21 x 17 cm
Weight/Shipping Weight	6.5 / 10.5 kg
Power Cord Length	1.6 m
Environmental	
Temperature (Operating / Storage)	0 – 50°C / -20 – 60°C
Humidity (Operating & Storage)	0 – 80% RH, Non-Condensing
Compliance	
EMC Verification	FCC Part 15 Class A, Others by Reuest
Safety Verification	TUV-CB, Others by Reuest

Package Contents

1. PE8324B
2. Standard Rack Mount Kit
3. Quick Start Guide
4. CD-ROM (Manual, eco Sensors Software)



Rack Mount Kit

Environment Sensors

Part No.	Sensor
EA1140	Temperature
EA1240	Temperature / Humidity
EA1340	Differential Pressure / Temperature
EA1440	Photo Door Sensor
EA1441	Inductive Proximity Door Sensor

Cable Holders

Part No.	Description
2X-EA07	Lok-U-Plug Cable Holder (10 pcs per pack) Patent Pending!
2X-EA08	Lok-U-Plug Installation Tool (4 pcs per pack)

• Lok-U-Plug Installation



Mounting Kit



Slide Rail Kit (2X-016G)



Button Mount Kit (2X-017G)



• Side Mount Installation

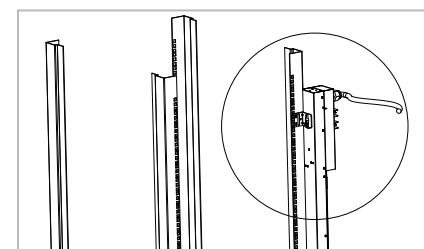

• Button Mount Installation



PE8324G ECO PDU

Description:	100-240V 32A 0U 24-Outlet PDU
Function:	24-Outlet Metering, 24-Outlet Switch Control & 2-Bank Metering
Input Power Plug:	IEC 60309 32A 
Power Capacity:	7.4 kW
Socket Configuration:	IEC 60320 C19 (3)  IEC 60320 C13 (21) 

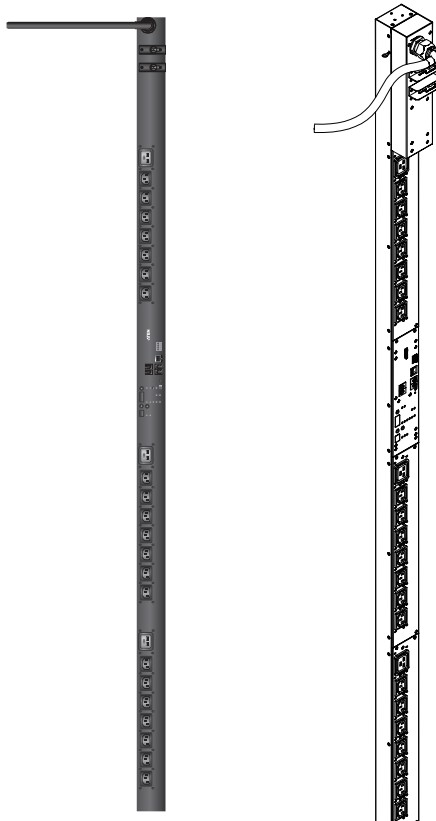

Features

Connections

- Supports 10/100Mbit Ethernet Interface
- Supports TCP/IP, UDP, HTTP, HTTPS, SSL, DHCP, ARP, NTP, DNS, Telnet, Auto Sense, Ping, SNMP V1,V2&V3,
- Supports three-level account/password security, IP/MAC filter, 128 bit SSL, RADIUS
- Supports, eco Sensors, multiple Browsers (IE, Firefox, Chrome, Safari)

Metering

- PDU and outlet level power metering and monitoring
- Environment monitoring – supports external temperature/temperature & humidity sensors for rack temperature and humidity monitoring
- Current, voltage, power, power dissipation, temperature, and humidity metering and threshold level setting
- Support door sensor

Outlet Switch Control

- Remote power outlet control (On/Off, Power Cycle) by individual outlets and outlet groups
- Outlet group support at the PDU
- Supports multiple power control methods – Wake on LAN, System After AC Back, Kill the Power
- Power-On sequencing – users can set the power-on sequence and delay time for each outlet to allow equipment to be powered on in the correct order
- Proactive overload protection(POP) – automatically powers off the last outlet that caused the current overload *Patent Pending!*

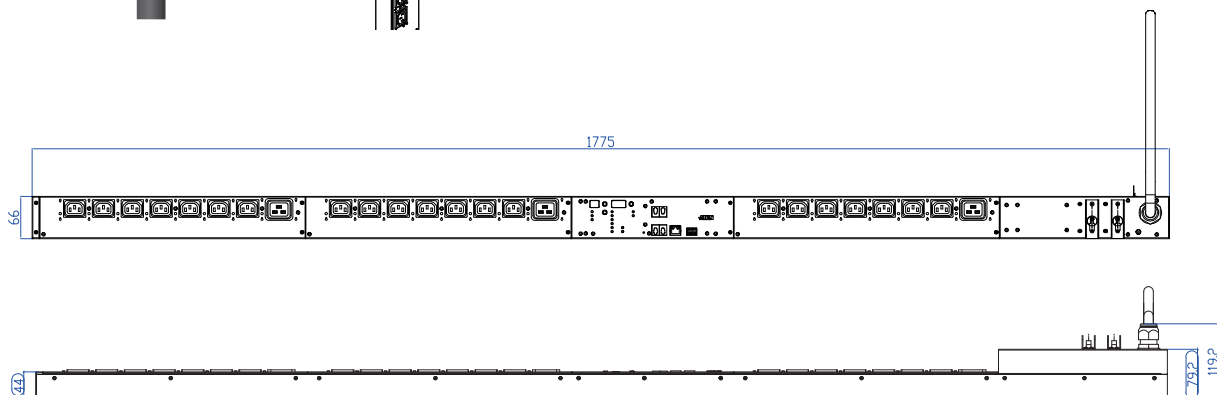

Specifications

Model	PE8324G
Electrical	
Nominal Input Voltage	100 – 240 VAC
Maximum Input Current	32A Max
Input Frequency	50-60 Hz
Input Connection	IEC 60309 32A
Input Power	7360 VA(Max)
Outlet Type	Total : 21 x IEC320 C13 + 3 x IEC320 C19 Bank1-1 : Outlet 1 – 8 ; 7 x C13 + 1 x C19 Bank1-2 : Outlet 9 – 16 ; 7 x C13 + 1 x C19 Bank2 : Outlet 17 – 24 ; 7 x C13 + 1 x C19
Nominal Output Voltage	100 – 240 VAC
Maximum Output Current (Outlet)	C13 : 10A (Max) C19 : 16A (Max), TUV De-rated 15A(Max)
Maximum Output Current (Bank)	16A(Max), TUV De-rated 15A(Max)
Maximum Output Current (Total)	32A(Max), TUV De-rated 30A(Max)
Breakers	2 x 16A UL489 Breaker
Metering	Per Outlet Level Current, Voltage, VA, PF, KWh Monitoring
Outlet Switch	Yes
Environment Sensor Port	4
Metering Accuracy	Voltage Range: 100VAC ~ 250VAC +/-1% Power Range: 100W ~ 5000W +/- 2% Current Range: 0.1A~1A +/- 0.1A, 1A~20A +/-1%
Mechanical	
Dimension (H x W x D)	177.5 x 6.6 x 4.4 cm
Shipping Dimensions (H x W x D)	189 x 21 x 17 cm
Weight/Shipping Weight	6.5 / 10.5 kg
Power Cord Length	1.6 m
Environmental	
Temperature (Operating / Storage)	0 – 40°C / -20 – 60°C
Humidity (Operating & Storage)	0 – 80% RH, Non-Condensing
Compliance	
EMC Verification	CE, Others by Request
Safety Verification	TUV-CB, CE-LVD, Others by Request

Package Contents

1. PE8324G
2. Standard Rack Mount Kit
3. Quick Start Guide
4. CD-ROM (Manual, eco Sensors Software)



Rack Mount Kit

Optional Accessories

Environment Sensors

Part No.	Sensor
EA1140	Temperature
EA1240	Temperature / Humidity
EA1340	Differential Pressure / Temperature
EA1440	Photo Door Sensor
EA1441	Inductive Proximity Door Sensor

Cable Holders

Part No.	Description
2X-EA07	Lok-U-Plug Cable Holder (10 pcs per pack) Patent Pending!
2X-EA08	Lok-U-Plug Installation Tool (4 pcs per pack)

• Lok-U-Plug Installation



Mounting Kit



Slide Rail Kit (2X-016G)



Button Mount Kit (2X-017G)

• Side Mount Installation



• Button Mount Installation

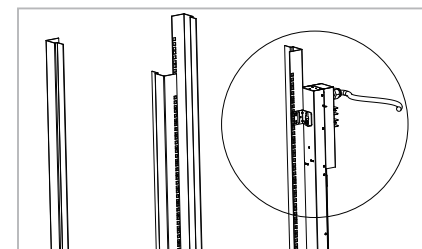

ATEN International Co., Ltd.

3F., No.125, Sec. 2, Datong Rd., Sijhih District., New Taipei City 221, Taiwan
 Phone: 886-2-8692-6789 Fax: 886-2-8692-6767
 www.aten.com E-mail: marketing@aten.com

NRGence_Full_Catalog_V1_2013_01



© Copyright 2013 ATEN® International Co., Ltd.
 ATEN and the ATEN logo are trademarks of ATEN International Co., Ltd.
 All rights reserved. All other trademarks are the property of their respective owners.